

External Dimensions

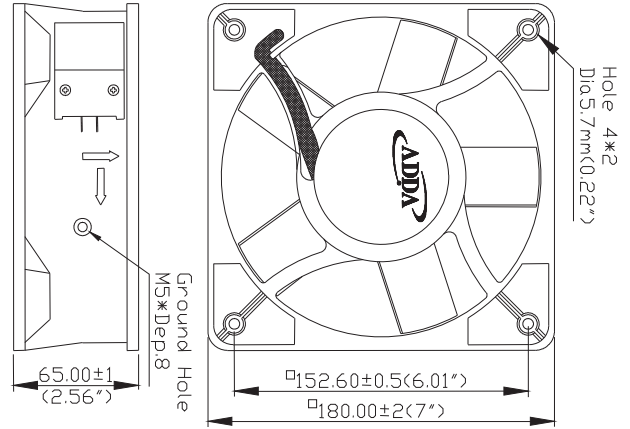

Frame: Aluminum Alloy
 Impeller: Plastic (UL:94V-0)
 Motor Structure: Capacitor-Run Induction Motor.
 Motor Protection: Thermal Protect.
 Lead wire: UL 1015AWG20
 OPERATING TEMP*: -10°C~70°C
 *: -10°C~60°C for fans with sleeve/ball combination bearings.

Specifications(Nominal)

*Noise is measured at the distance of one (1) meter from the axis of intake.



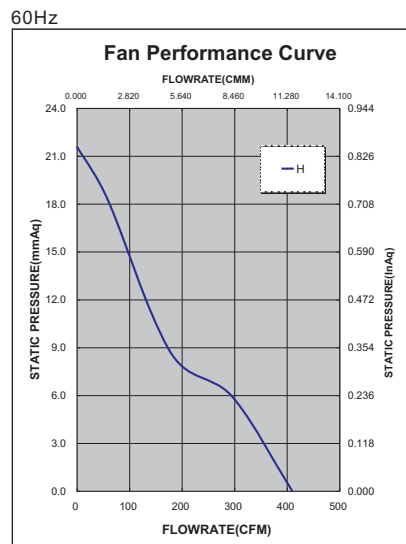
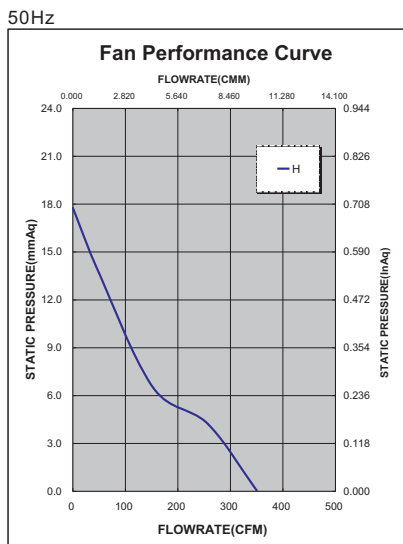

Bearing type: ◎=Ball ※=Sleeve ●=Hypro bearing

Frame size (mm)	Model No.	Bearing System Type	Volt. (VAC)	Freq. (Hz)	Current (A)	Power (W)	Rated Speed (rpm)	Maximum AirFlow (CMM)	Maximum AirFlow (CFM)	Maximum Pressure (InAq)	Maximum Pressure (mmAq)	*Noise Level (dB/A)	Weight (g)
180x180x65	AK1861HB	◎	115	50/60	0.55/0.48	59.80/55.20	2800/3200	9.905/11.603	350.0/410.0	0.700/0.850	17.780/21.590	70.0/72.0	1800
	AK1862HB		230		0.20/0.22	46.50/51.10							

Specifications subject to change without notice.



*Safety approvals

				
✓	✓		✓	✓

X-ON Electronics

Largest Supplier of Electrical and Electronic Components

Click to view similar products for [adda manufacturer](#):

Other Similar products are found below :

[AD0305LX-K70-LF](#) [AD0424HB-C50-LF](#) [664-P4505MX-G90-LF](#) [AD0424HX-G70](#) [AD0205MX-G50GL-LF](#) [AD1224HX-A71GL-LF](#)
[AD0712MB-A76GL-LF](#) [AD1212HB-A71GL-LF](#) [AD0912HB-A73GL-LF](#) [AB05012DX-200300](#) [AD0505LB-G70\(T1\)](#) [AA8382HB-AT-LF](#)
[AD08024HX-257004-LF](#) [AD1248HB-F51\(FN\)](#) [AA1281MB-AT-LF](#) [AA1281UX-AT-LF](#) [AD1248HB-F51-LF](#) [AD0505LB-G70\(8\)-LF](#)
[AA8382MX-AT-LF](#) [AD0812HB-C70-LF](#) [FG92-W2](#) [AD0412LB-C71GP](#) [AD08024UX257304-LF](#) [AD0405MB-C50-LF](#) [AD0612MX-](#)
[A70GL-LF](#) [AK1782HB-AT-LF](#) [AD1212HB-Y53-LF](#) [026022D](#) [AD0412HX-C50-LF](#) [AP0412MX-J70-LF](#) [AB3505MX-QB0-LF](#) [AD0924UB-](#)
[A71GL-LF](#) [AD0712UB-A76GL-LF](#) [AD0924HB-C70-LF](#) [AD0412HB-G76-LF](#) [AD0624HB-A70GL\(T\)](#) [AD1212XB-A7BGL-LF](#) [AD7524UB-](#)
[LF](#) [AD0312MB-G56-LF](#) [AA1281HB-AT-LF](#) [AD0824VB-A71GP](#) [AS12024UB25A100](#) [AD0512HB-G70-LF](#) [AD0912HX-A70GL-LF](#)
[AD1224HX-F51-LF](#) [AQ1212LB-A71GL-LF](#) [AD0412DB-C50](#) [AS12012MB-25A100-LF](#) [AK1781HB-AW-LF](#) [AD0405LB-G70](#)