



富鼎先進電子股份有限公司
ADVANCED POWER ELECTRONICS CORP.

Address: 12F-1&2, No.5, Taiyuan 1 ST., Zhubei
City, Hsinchu County 30265, Taiwan,
R.O.C.Tel:886-3-6215899 Fax:886-3-6215999
E-mail:mail@a-power.com.tw

承 認 書

Specification Sheet

Customer : 電創國際有限公司

Customer Part Number	AP9435GM-HF
APEC Part Number	AP9435GM-HF
Issued Date	2015/04/08
SPEC No.	SPEC-201504-0007

APEC Approved		
Sales Manager	Sales	QA

Customer Approved			
Dept.			
Signature			



Item	Contents	Page
1	Data Sheet	p1~p5
2	Package Outline	p6~p7
3	Packing Standard	p8~p15
4	Material List	p16~p17
5	IR Reflow	p18
6	Reliability Test Report	AnnexI p1~p8



- ▼ Simple Drive Requirement
- ▼ Low Gate Charge
- ▼ Fast Switching Characteristic
- ▼ RoHS Compliant & Halogen-Free

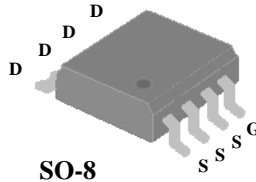

BV_{DSS}	-30V
$R_{DS(ON)}$	50m Ω
I_D	-5.3A

Description

AP9435 series are from Advanced Power innovated design and silicon process technology to achieve the lowest possible on-resistance and fast switching performance. It provides the designer with an extreme efficient device for use in a wide range of power applications.

The SO-8 package is widely preferred for all commercial-industrial surface mount applications using infrared reflow technique and suited for voltage conversion or switch applications.

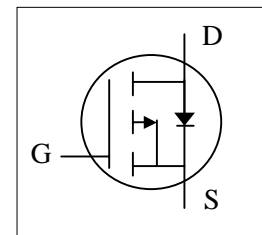

Absolute Maximum Ratings @ $T_j=25^\circ\text{C}$ (unless otherwise specified)

Symbol	Parameter	Rating	Units
V_{DS}	Drain-Source Voltage	-30	V
V_{GS}	Gate-Source Voltage	+20	V
$I_D@T_A=25^\circ\text{C}$	Drain Current ³ , V_{GS} @ 10V	-5.3	A
$I_D@T_A=70^\circ\text{C}$	Drain Current ³ , V_{GS} @ 10V	-4.7	A
I_{DM}	Pulsed Drain Current ¹	-20	A
$P_D@T_A=25^\circ\text{C}$	Total Power Dissipation	2.5	W
	Linear Derating Factor	0.02	W/ $^\circ\text{C}$
T_{STG}	Storage Temperature Range	-55 to 150	$^\circ\text{C}$
T_J	Operating Junction Temperature Range	-55 to 150	$^\circ\text{C}$

Thermal Data

Symbol	Parameter	Value	Unit
Rthj-a	Maximum Thermal Resistance, Junction-ambient ³	50	$^\circ\text{C/W}$

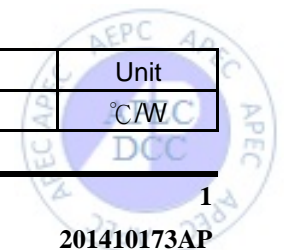



AP9435GM-HF

Electrical Characteristics @T_j=25°C(unless otherwise specified)

Symbol	Parameter	Test Conditions	Min.	Typ.	Max.	Units
BV _{DSS}	Drain-Source Breakdown Voltage	V _{GS} =0V, I _D =-250uA	-30	-	-	V
R _{DS(ON)}	Static Drain-Source On-Resistance ²	V _{GS} =-10V, I _D =-5A	-	-	50	mΩ
		V _{GS} =-4.5V, I _D =-4A	-	-	90	mΩ
V _{GS(th)}	Gate Threshold Voltage	V _{DS} =V _{GS} , I _D =-250uA	-1	-	-3	V
g _{fs}	Forward Transconductance	V _{DS} =-10V, I _D =-5A	-	5	-	S
I _{DSS}	Drain-Source Leakage Current	V _{DS} =-24V, V _{GS} =0V	-	-	-30	uA
I _{GSS}	Gate-Source Leakage	V _{GS} =±20V, V _{DS} =0V	-	-	±100	nA
Q _g	Total Gate Charge	I _D =-5.3A	-	14.6	-	nC
Q _{gs}	Gate-Source Charge	V _{DS} =-15V	-	1.8	-	nC
Q _{gd}	Gate-Drain ("Miller") Charge	V _{GS} =-10V	-	3.7	-	nC
t _{d(on)}	Turn-on Delay Time	V _{DS} =-15V	-	6.6	-	ns
t _r	Rise Time	I _D =-1A	-	7.7	-	ns
t _{d(off)}	Turn-off Delay Time	R _G =3.3Ω	-	22	-	ns
t _f	Fall Time	V _{GS} =-10V	-	9.3	-	ns
C _{iss}	Input Capacitance	V _{GS} =0V	-	570	-	pF
C _{oss}	Output Capacitance	V _{DS} =-25V	-	80	-	pF
C _{rss}	Reverse Transfer Capacitance	f=1.0MHz	-	75	-	pF

Source-Drain Diode

Symbol	Parameter	Test Conditions	Min.	Typ.	Max.	Units
V _{SD}	Forward On Voltage ²	I _S =-2.1A, V _{GS} =0V	-	-	-1.2	V
t _{rr}	Reverse Recovery Time	I _S =-5A, V _{GS} =0V,	-	18	-	ns
Q _{rr}	Reverse Recovery Charge	di/dt=100A/μs	-	11	-	nC

Notes:

- 1.Pulse width limited by Max. junction temperature.
- 2.Pulse test
- 3.Surface mounted on 1 in² copper pad of FR4 board, t ≤ 10s ; 125 °C/W when mounted on Min. copper pad.

THIS PRODUCT IS SENSITIVE TO ELECTROSTATIC DISCHARGE, PLEASE HANDLE WITH CAUTION.

USE OF THIS PRODUCT AS A CRITICAL COMPONENT IN LIFE SUPPORT OR OTHER SIMILAR SYSTEMS IS NOT AUTHORIZED.

APEC DOES NOT ASSUME ANY LIABILITY ARISING OUT OF THE APPLICATION OR USE OF ANY PRODUCT OR CIRCUIT DESCRIBED HEREIN; NEITHER DOES IT CONVEY ANY LICENSE UNDER ITS PATENT RIGHTS, NOR THE RIGHTS OF OTHERS.

APEC RESERVES THE RIGHT TO MAKE CHANGES WITHOUT FURTHER NOTICE TO ANY PRODUCTS HEREIN TO IMPROVE RELIABILITY, FUNCTION OR DESIGN.

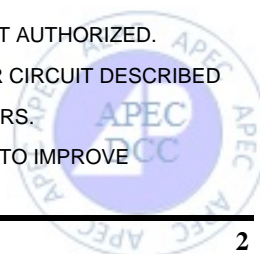

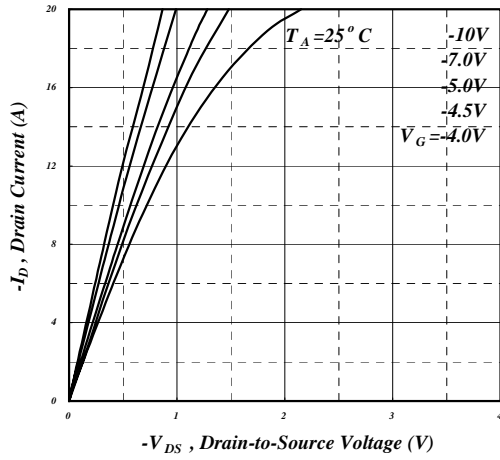

Fig 1. Typical Output Characteristics

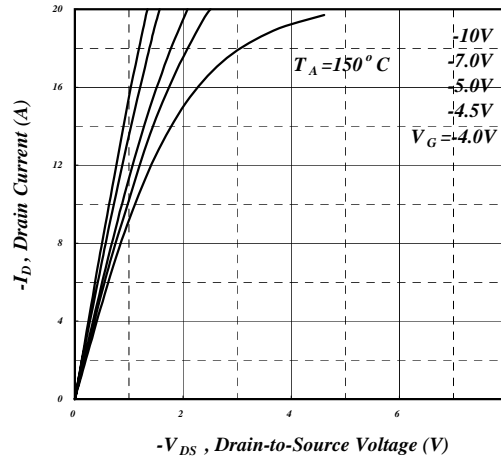

Fig 2. Typical Output Characteristics

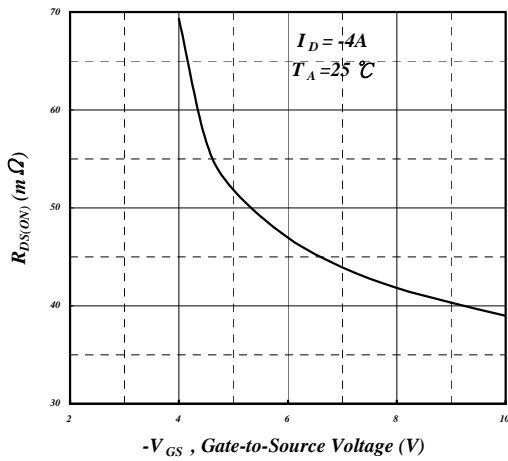

Fig 3. On-Resistance v.s. Gate Voltage

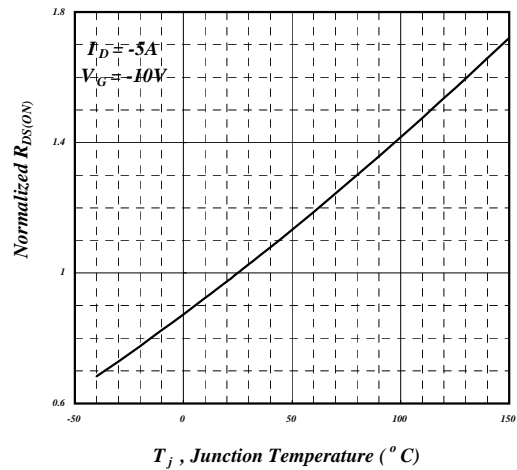

Fig 4. Normalized On-Resistance v.s. Junction Temperature

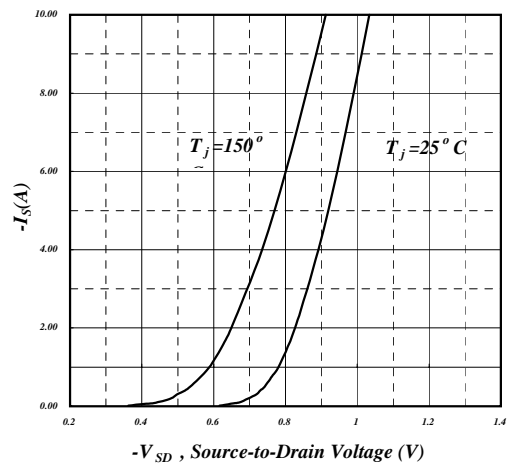

Fig 5. Forward Characteristic of Reverse Diode

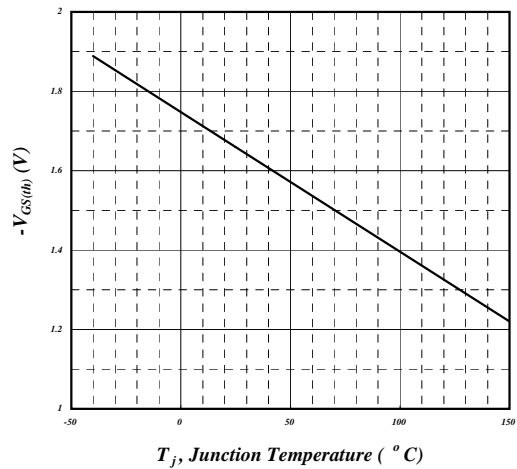
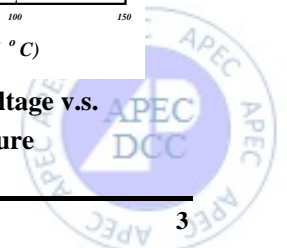

Fig 6. Gate Threshold Voltage v.s. Junction Temperature



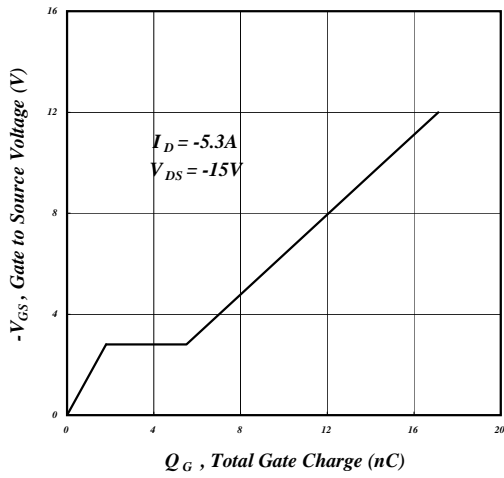

Fig 7. Gate Charge Characteristics

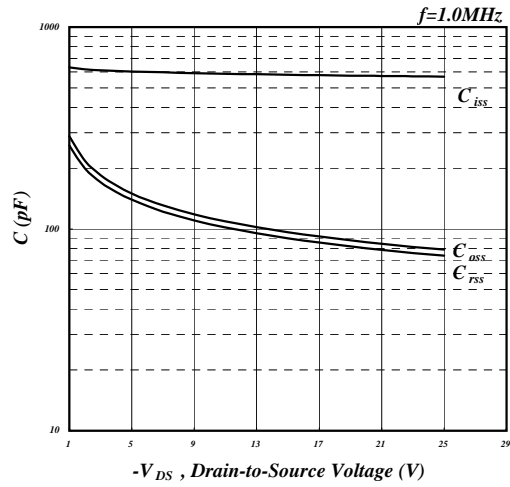

Fig 8. Typical Capacitance Characteristics

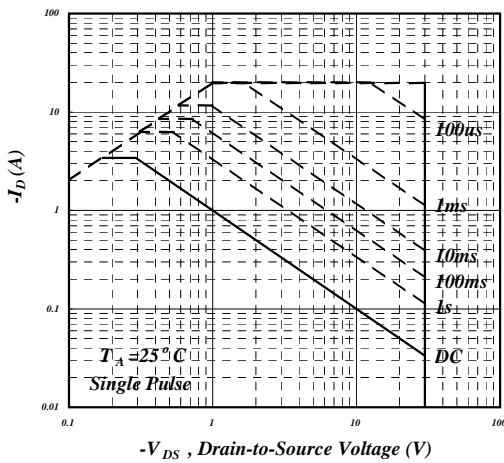

Fig 9. Maximum Safe Operating Area

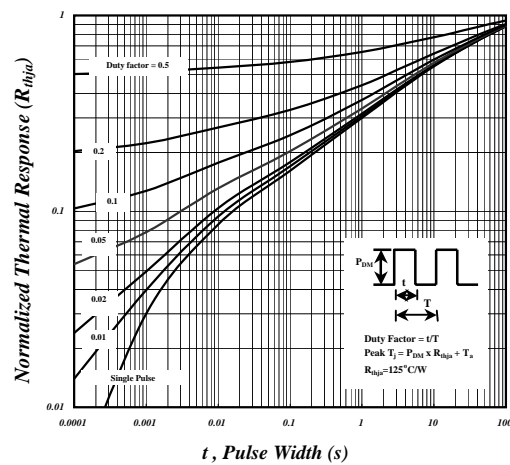

Fig 10. Effective Transient Thermal Impedance

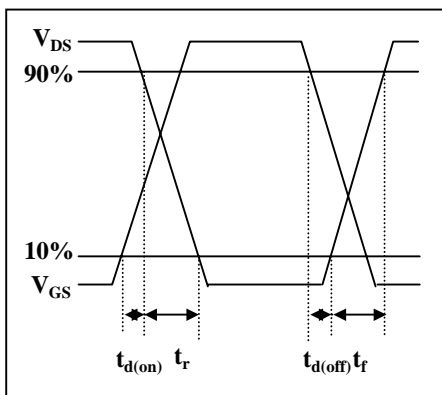

Fig 11. Switching Time Waveform

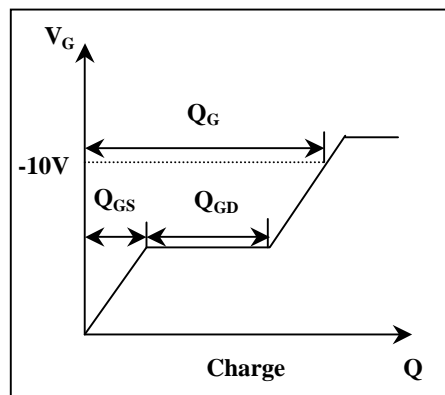
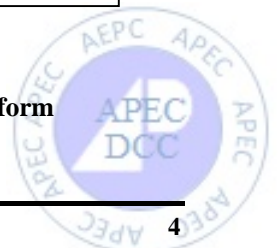
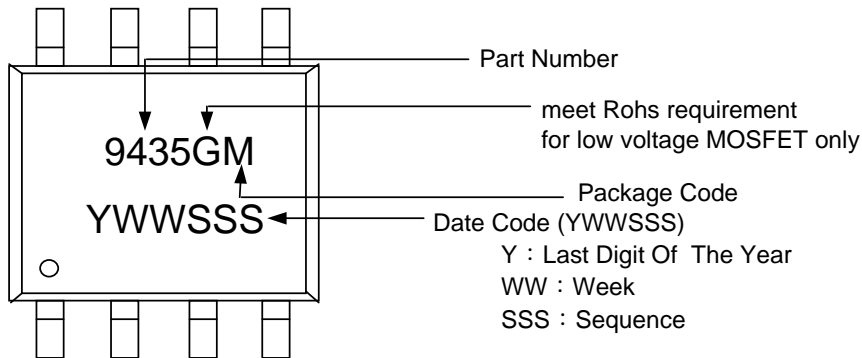

Fig 12. Gate Charge Waveform





MARKING INFORMATION





Package Outline : SO-8

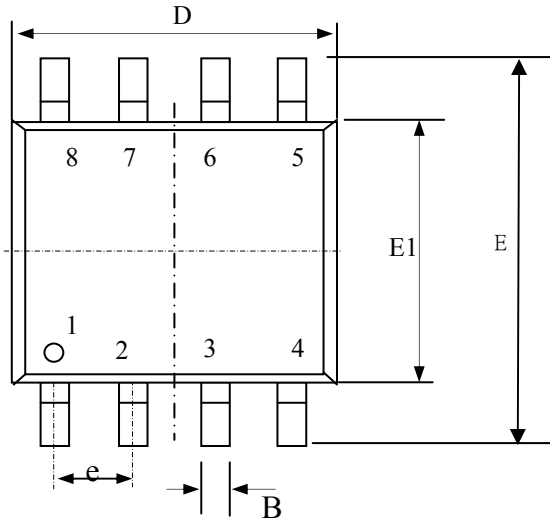

SYMBOLS	Millimeters		
	MIN	NOM	MAX
A	1.35	1.55	1.75
A1	0.05	0.15	0.25
B	0.30	0.41	0.51
D	4.80	5.05	5.30
E	5.79	6.00	6.20
E1	3.70	3.90	4.10
e	1.27 TYP		
G	0.17	0.21	0.25
F	0.38	0.83	1.27
α	0°	4°	8°

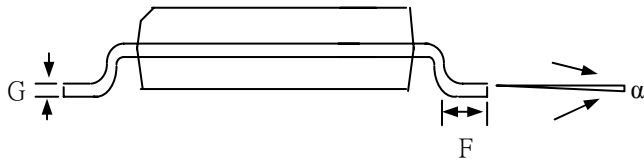
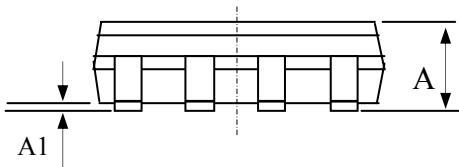

- 1.All Dimension Are In Millimeters.
- 2.Dimension Does Not Include Mold Protrusions.

Draw No. M1-M8-G-v03





SO-8 FOOTPRINT :

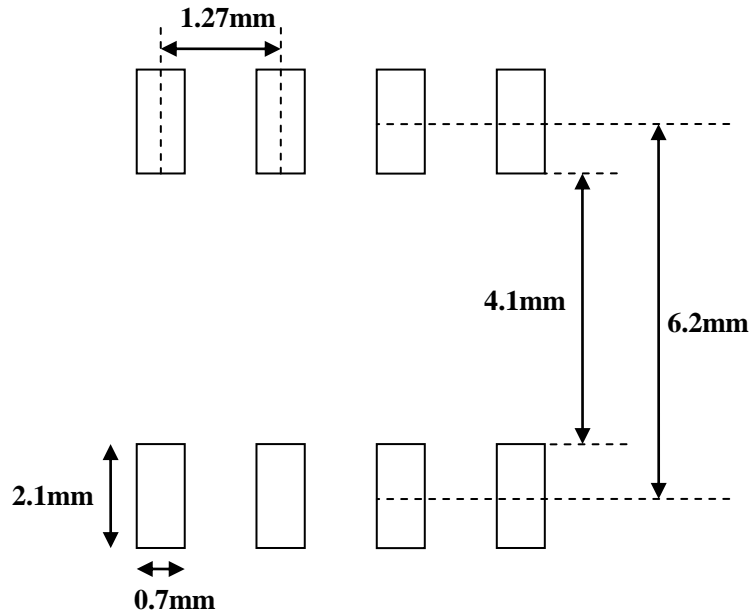

富鼎先進電子股份有限公司

包裝規範

(5.1.5 USE BUBLE PLASTIC MATERIAL INSIDE THE CARTON THEN PUT THE
WAFER BOX ONTO CARTON. AS ATTACHMENT 十一-3)

5.2 PACKAGE 產品包裝作業規定(5.2 PACKAGED FG PACKING STANDARD.)

5.2.1 管條(TUBE)之裝箱法(5.2.1 TUBE PACKING STANDARD.)

5.2.1.1

PKG TYPE	TO-220	TO-220CFM	TO-262	DIP-8	TO-3P	TO-251	TO-247
TUBE	50ea	50ea	50ea	50ea	30ea	80ea	30ea
INNER BOX	1000ea/Box	1000ea/Box	1000ea/Box	3000ea/Box	360ea/Box	8000ea/Box	240ea/Box
OUTER CORTON	6000ea/carton	6000ea/carton	6000ea/carton	12000ea/carton	1440ea/carton	40000ea/carton	1200ea/carton
CARTON DIMENSION	Attachment (一)	Attachment(一) Attachment (一-1)	Attachment (一)	Attachment (五)	Attachment (七)	Attachment(四)	Attachment (十二)

5.2.1.2 尾數箱裝箱時需將剩餘空間，以小內盒或氣泡膠填充之。

(5.2.1.2 NEED TO PUT EMPTY INNER BOX INSIDE OUTER CARTON
FOR NON FULL PACKED CARTON.)

5.2.2 捲型包裝(TAPE&REEL)之裝箱法

(5.2.2 TAPE & REEL PECKING STANDARD.)

5.2.2.1

PKG TYPE	TO-252/ SOT-223	TO-263	SO-8/TSSOP-8/ ESOP-8/ PMPAK/ MESOP-8/ MESOP-10 DFN 3×3	SOT-23/5/6/ SOT-323/363 SC70-4L/5L/ TSOT-23/5/6 DNF 3×2/ DFN 2×2	SOT-89	GEM2928-8	TO-92
REEL	3000ea	800ea	3000ea	3000ea	1000ea	3000ea	2000ea
INNER BOX	6000ea/Box	800ea/box	6000ea/box	15000ea/box	4000ea/box	15000ea/box	2000ea/box
OUTER CORTON	24000ea/carton	4000ea/carton	48000ea/carton	150000ea/carton	40000ea/carton	150000ea/box	32000ea/box
CARTON DIMENSION	Attachment (二)	Attachment (二)	Attachment (三)	Attachment (二)	Attachment (二)	Attachment (二)	Attachment (八)
REEL SPEC.	Figure 一/六	Figure 三	Figure 二/八/十一	Figure 四/十/十二 /十三/十四	Figure 五	Figure 七	Figure 九

5.2.2.2 尾數箱裝箱時需將剩餘空間，以小內盒或氣泡膠填充之。

文件編號：QWMP-7801

版 別：40

頁 碼：2

版權屬於富鼎所有，禁止任何未經授權的使用
The copyright belongs to APEC. Any unauthorized use is prohibited.



富鼎先進電子股份有限公司

包裝規範

(5.2.2.2 NEED TO PUT EMPTY INNER BOX OUTER CARTON FOR NON FULL PACKED CARTON.)

5.2.2.3 單一料捲只允許二個不同 DATA CODE 併捲。

(5.2.2.3 Only allow 2 different date code to be combined into one reel.)

5.2.3 靜電袋之裝箱法(5.2.3 BAG PACKING STANDARD.)

PKG TYPE	TO-220	TO-251/TO-92
BAG	50ea	100ea
INNER BOX	500ea/box	10000ea/box
OUTER CORTON	4000ea/carton	40000ea/carton
CARTON DIMENSION	Attachment (六)	Attachment (八)

5.2.3.2 尾數箱裝箱時需將剩餘空間，以小內盒氣泡膠填充之。

(5.2.3.2 NEED TO PUT EMPEY INNER BOX INSIDE OUTER CARTON FOR NON FULL PACKED CARTON.)

5.3 不同產品不可裝入同一箱子內，以避免產品混料。

(5.3 NO ANY DIFFERENT P/N FG INSIDE SAME CARTON.)

5.4 包裝箱標籤：整貨裝箱後將型號數量標籤(如附件七)貼在紙箱及小內盒側面。

(5.4 LABELING : ATTACH LABEL ONTO INNER BOX & OUTER CARTON AS ATTAHMENT 七.)

5.5 真空包裝：產品料卷放入抗靜電鋁箔袋中，同乾燥劑及濕度指示卡一起抽真空後，再置入內盒(Pizza Box)

5.5.1.真空包裝之裝箱法：

PKG TYPE	TO-252/ SOT-223	TO-263	SO-8/TSSOP-8/ ESOP-8/PMPAK/ MESOP-8/MESOP-10 DFN 3×3	SOT-23/25/26 SOT-323/363 SC70-4L/5L TSOT-23/5/6 DNF 3×2/ DFN 2×2	SOT-89	GEM2928-8
REEL	3000ea	800ea	3000ea	3000ea	1000ea	3000ea
INNER BOX	6000ea/Box	800ea/box	6000ea/box	12000ea/box	3000ea/box	15000ea/box
OUTER CORTON	24000ea/carton	4000ea/carton	48000ea/carton	120000ea/carton	30000ea/carton	150000ea/box
CARTON DIMENSION	Attachment (二)	Attachment (二)	Attachment (三)	Attachment (二)	Attachment (二)	Attachment(二)
REEL SPEC.	Figure 一/六	Figure 三	Figure 二/八/十一	Figure 四/十/十二 /十三/十四	Figure 五	Figure 七

文件編號：QWMP-7801

版 別：40

頁 碼：3

版權屬於富鼎所有，禁止任何未經授權的使用
The copyright belongs to APEC. Any unauthorized use is prohibited.

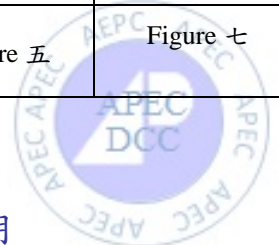

富鼎先進電子股份有限公司

包裝規範

5.5.2. 7 吋料卷如附件(九)

5.2.3. 13 吋料卷如附件(十)

*以上依客戶需求使用之。

5.6 包裝檢驗：裝箱完成後通知 QA 檢驗，檢驗合格則蓋上檢查合格章後等待出貨。

(5.6 PACKING INSPECTION：STAMP QA IN SPETION ONTO LABEL AFTER COMPLETELY PACKING STEP.)

6.外購成品的包裝規範依客戶要求。

(6. THE PACKING SPEC. OF PURCHASED FG IS FOLLOWED BY CUSTOMER'S REQUIREMENT.)

7. 相關文件：無

(7. DOCUMENT：NO)

附件七：外箱標籤 (*CARTON LABEL*)

檢驗合格標章樣式：



有鉛產品標籤(For Pb-Sn Product)：

	富鼎先進電子股份有限公司 ADVANCED POWER ELECTRONICS CORP.
P/N：	<input type="text"/>
DateCode：	<input type="text"/>
Q'TY	<input type="text"/>
QC：	<input type="text"/>

(檢 查
合 格)

文件編號：QWMP-7801

版 別：40

頁 碼：4

版權屬於富鼎所有，禁止任何未經授權的使用
The copyright belongs to APEC. Any unauthorized use is prohibited.



富鼎先進電子股份有限公司

包裝規範

無鉛產品標籤(For Pb Free Product)：



2014年13週以前開立的工單



2014年14週以後開立的工單

無鹵產品標籤(For Halogen Free Product)：



2014年13週以前開立的工單



2014年14週以後開立的工單

貼於產品標籤面右上角：

G. P. PASS

晶片盒標籤：(For Wafer Box)

<input type="checkbox"/>	NO/CP	<input checked="" type="checkbox"/>	CP	<input checked="" type="checkbox"/>	良品	<input type="checkbox"/>	工程
P/N :	 AN0317EARP						
LOT NO :	 JYJJ718						
Q'ty :	 4 #01-04						

文件編號：QWMP-7801

版 別：40

頁 碼：5

版權屬於富鼎所有，禁止任何未經授權的使用
The copyright belongs to APEC. Any unauthorized use is prohibited.



富鼎先進電子股份有限公司

包裝規範

Attachment 3 : SO-8 、 ESOP-8 、 TSSOP-8 、 PMPAK 、 MESOP-8 、 MESOP-10 、 DFN 3×3 Carton

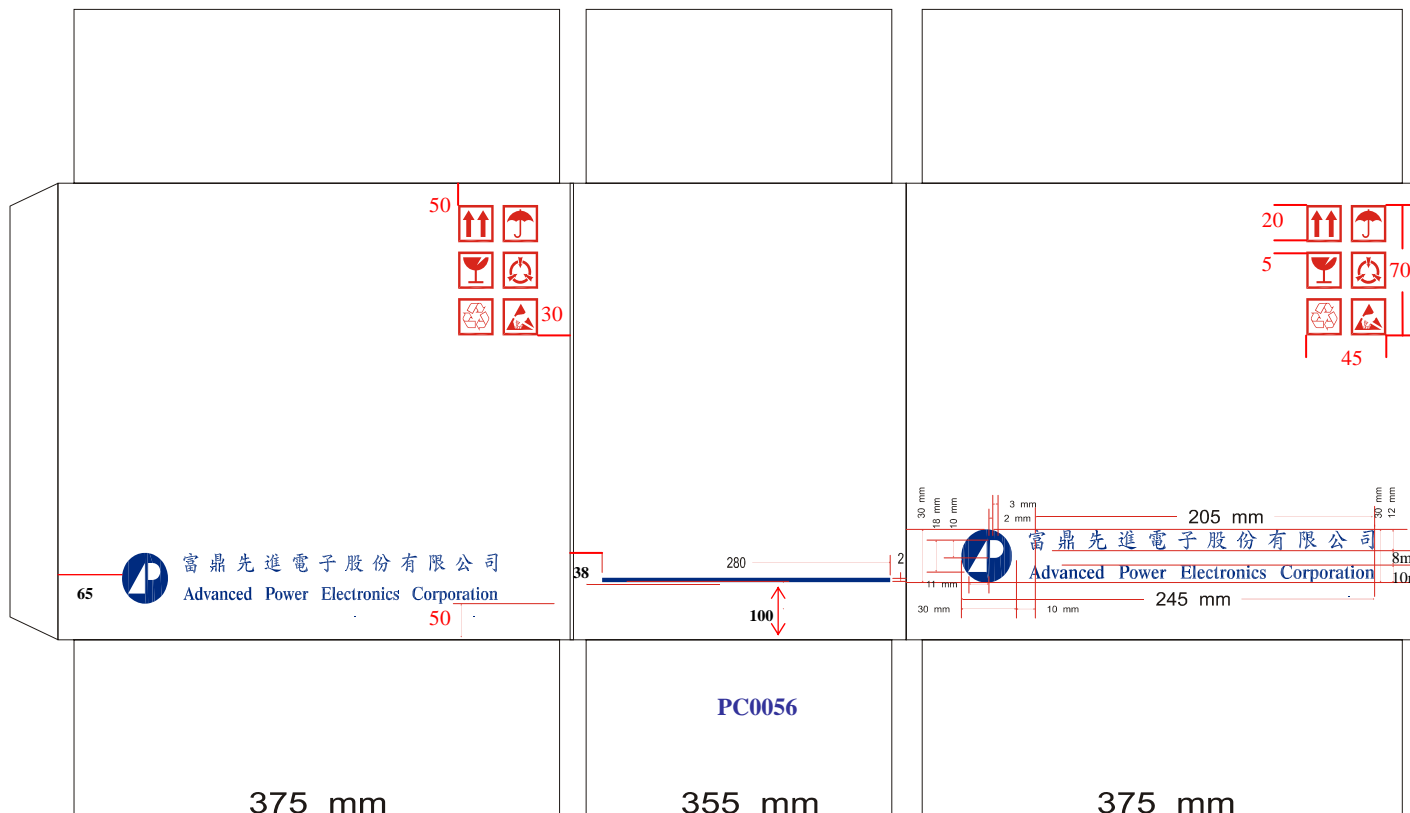

文件編號：QWMP-7801

版 別：40

頁 碼：9

版權屬於富鼎所有，禁止任何未經授權的使用
The copyright belongs to APEC. Any unauthorized use is prohibited

富鼎先進電子股份有限公司

包裝規範

附圖二：Tape & Reel Information : SO-8/ESOP-8

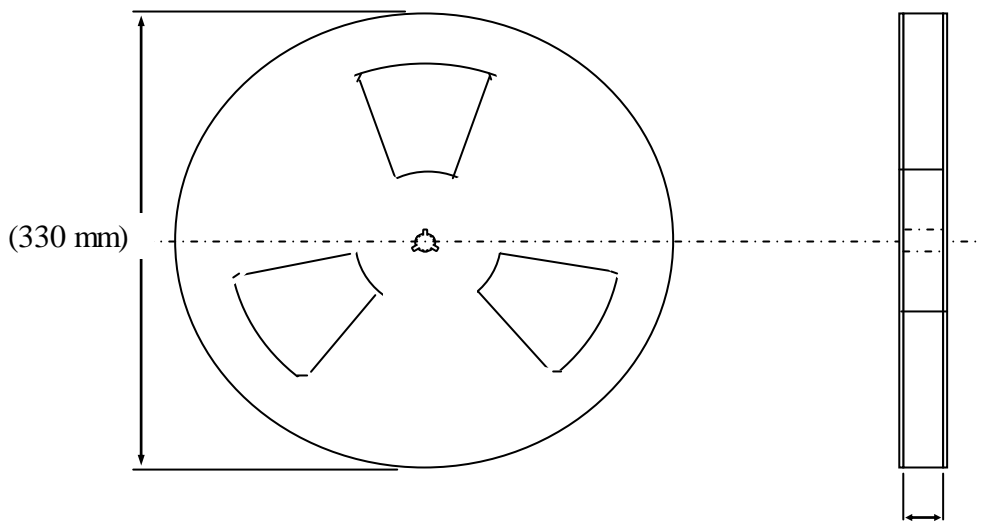
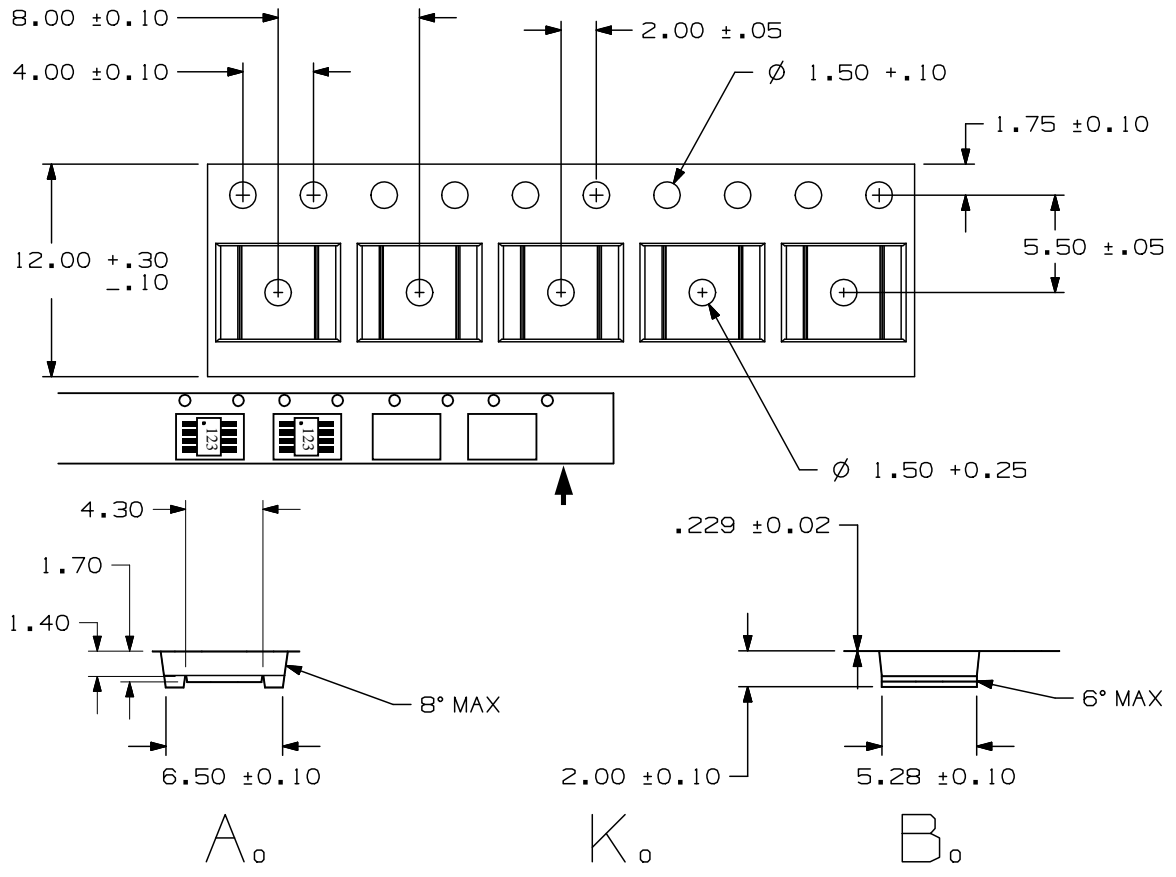

1. All Dimensions Are Shown in Millimeters.
2. Packing : 3000 pcs / reel.



富鼎先進電子股份有限公司

包裝規範

附件十：

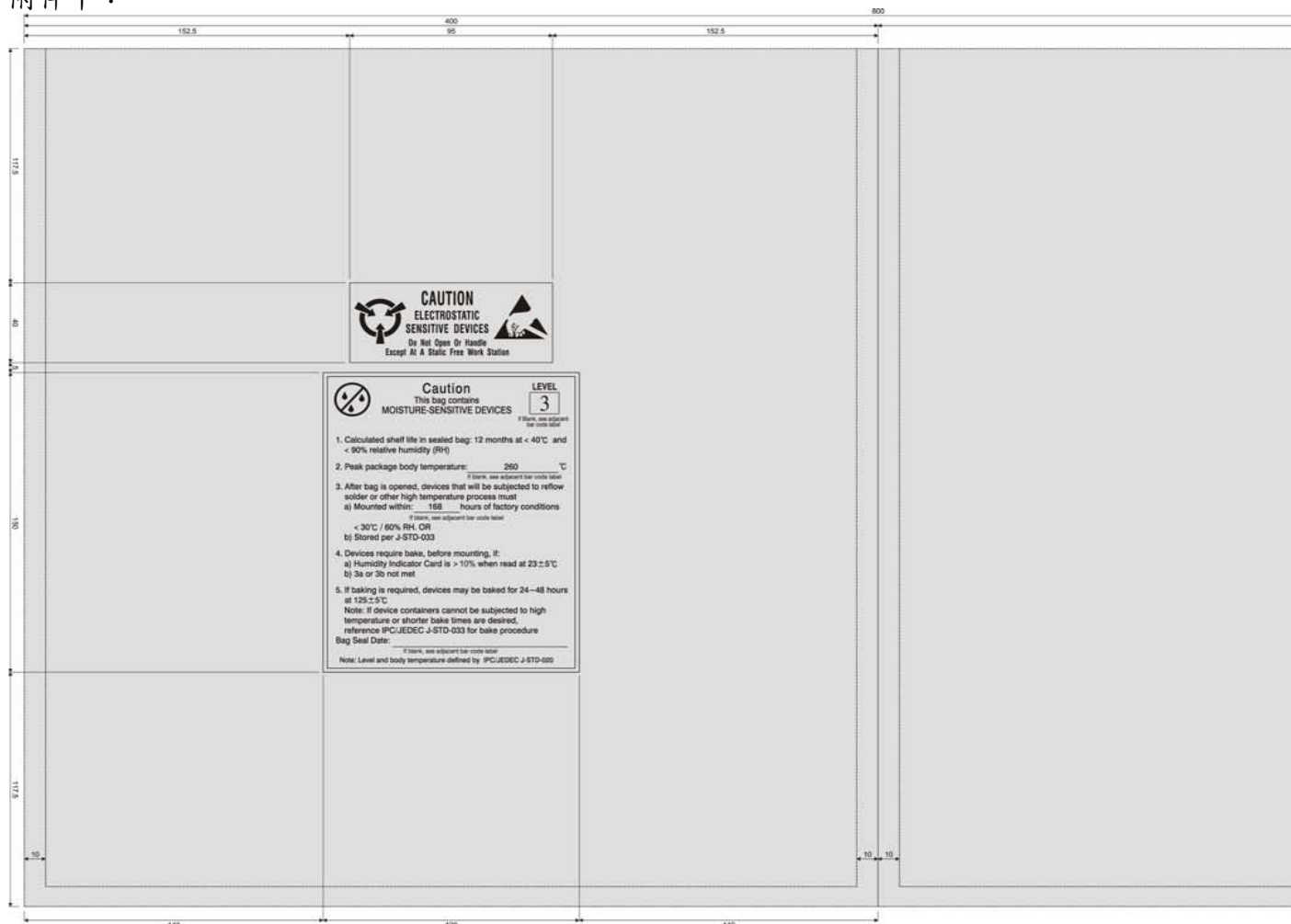

圖號	00
產品代號	80004301 (三層封)
標準代號	8000430
日期	2011
核准日期	2011
圖號	AL4304301

文件編號：QWMP-7801

版 別：39

頁 碼：34

版權屬於富鼎所有，禁止任何未經授權的使用
The copyright belongs to APEC. Any unauthorized use is prohibited

富鼎先進電子股份有限公司 包裝規範

附件十-1：



文件編號：QWMP-7801

版 別：39

頁 碼：35

版權屬於富鼎所有，禁止任何未經授權的使用
The copyright belongs to APEC. Any unauthorized use is prohibi



富鼎先進電子股份有限公司
ADVANCED POWER ELECTRONICS CORP.

SO8-HF(M) Material list

Parts	Material Supplier	Material P/N	Country		Parts weight (mg)	Substance	weight	
Compound	SUMITOMO	EME-G600FB	China	32.39%	24.743	Epoxy Resin A	1.9	
						Epoxy Resin B	0.1	
						Phenol Resin	0.7	
						Silica(Amorphous) A	21.0	
						Silica(Amorphous) B	0.7	
						Carbon Black	0.1	
Die Attach	HENKEL	84-1LMISR4	China	0.43%	0.325	Silver	0.2	
						Epoxy resin	0.0	
						1.4-butanedioldiglycidyl	0.0	
						Aromatic amine	0.0	
Lead Frame	ASM	A194	China	65.95%	50.382	Cu	48.7	
						Fe	1.1	
						Pb	0.0	
						P	0.0	
						Zn	0.0	
						Ag	0.3	
Plating	Yunnan	Sn	China	1.11%	0.85	Tin	0.8	
Wire	NIPPON	EX1	China	0.13%	0.1	Cu	0.1	
						Pd	0.0	
					100.00%	76.40		76.4



富鼎先進電子股份有限公司

SO8-HF(E) Material list

Parts	Material Supplier	Material P/N	Country		Parts Weight (mg)	Substance	Weight (mg)
Compound	Sumitomo	EME-G600FL	China	56.97%	46.74	Epoxy Resin	2.34
						Epoxy,Cresol noolac	0.70
						Phenol Resin	2.34
						Carbon Black	0.14
						Silica fused	41.22
Die Attach	Kyocera	CT285	Japan	0.82%	0.67	Silver	0.58
						Epoxy Resin dilluent	0.03
						Mixture of Epoxy resin and its hardener	0.03
						2.3-Epoxypropylphenyl ether	0.03
Leadframe	ASM	A194	Hong Kong	40.44%	33.18	Copper	31.50
						Iron	0.78
						Lead	0.00
						Phosphorus(p)	0.03
						Zinc(Zn)	0.04
						Silver	0.83
Plating	ASEM	Sn99.99	China	1.33%	1.09	Tin	1.09
Wire	Tanaka/Heraeus	Cu wire	Singapore	0.45%	0.37	Cu	0.37
				100.00%	82.05	82.05	

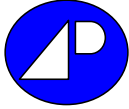

ADVANCED POWER ELECTRONICS CORP.

Recommended Reflow Profile for Lead(Pb) Free Soldering (Pure Matte Tin Plating)

Lead(Pb) free solders which require to use higher reflow temperature. Advanced Power Electronics Corp. has studied the reliability of our products at higher reflow temperature. Customer may use below temperature profile for the solders requirement.

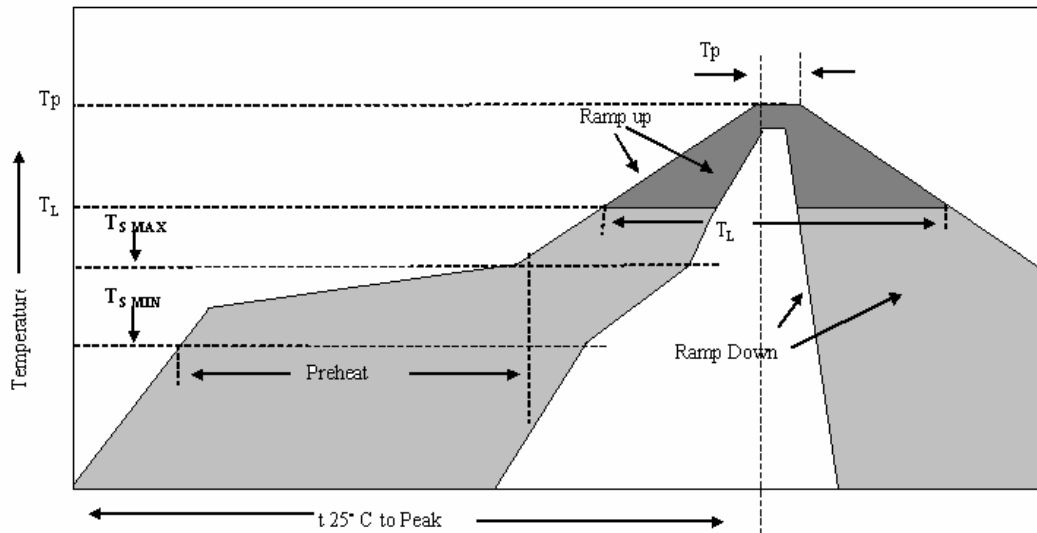

Table 1. Lead-Free Reflow Profile Recommendation (IPC/JEDEC J-STD-020C)	
Reflow Parameter	Lead-Free Assembly
Minimum preheat temperature ($T_{s \text{ MIN}}$)	150° C
Maximum preheat temperature ($T_{s \text{ MAX}}$)	200° C
Preheat Time	60-180 seconds
$T_{s \text{ MAX}}$ TO T_L ramp-up rate	3° C/second maximum
Time above temperature T_L (t_L)	217° C 60-150 seconds
Peak Temperature (T_p)	260° C
Time 25 C To T_p	8 minute maximum
Time within 5c of Peak T_p	20-40 seconds
Ramp-down rate	6° C/second maximum

* Could meet three 3 cycles





Reliability Test Report

AP9435GM-HF

- I. **Accelerated Life Times Stress Test**
- II. **Environmental Stress Test**

SO-8(M)

Approved by	Prepared by
<i>M. D. Lin</i>	<i>S. H. Tsai</i>
Date: 2012/9/19	Date: 2012/9/19

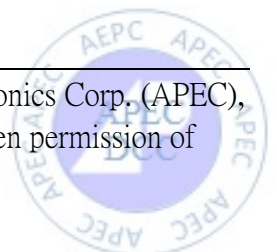

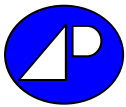
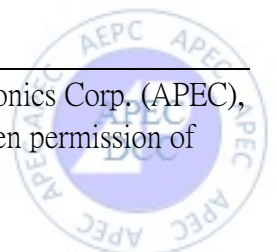

TABLE OF CONTENTS

	Page
1. Introduction	3
2. Test Procedure	3
2.1 Pre-Condition (SMD Packages devices only)	
2.2 Sampling Plan	
3. Accelerated Life Time Stress Tests	4
3.1 Test Level	
3.2 Test Result	
3.3 Test Item Description	
3.3.1 High Temperature Gate Bias (HTGB)	
3.3.2 High Temperature Reverse Bias (HTRB)	
4. Environmental & Package Stress Tests	5
4.1 Test Level	
4.2 Test Result	
4.3 Test Item Description	
4.3.1 High Temperature Storage Test (HTST)	
4.3.2 High Temperature & Humidity Reverse Bias (H3TRB)	
4.3.3 Temperature Humidity Storage Test (THST)	
4.3.4 Power Cycling Test (PRCL)	
4.3.5 Temperature Cycling Test (TCT)	
4.3.6 Pressure Cooker Test (PCT)	
4.3.7 Thermal Shock Test (TST)	
4.3.8 Highly Accelerated Stress Test (HAST)	





1. Introduction

This report records the APEC product reliability test procedure, items and results; give a clear overview of reliability qualification test.

2. Test Procedure

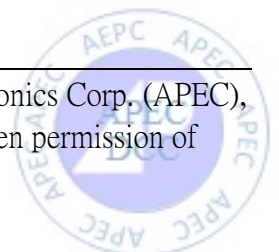
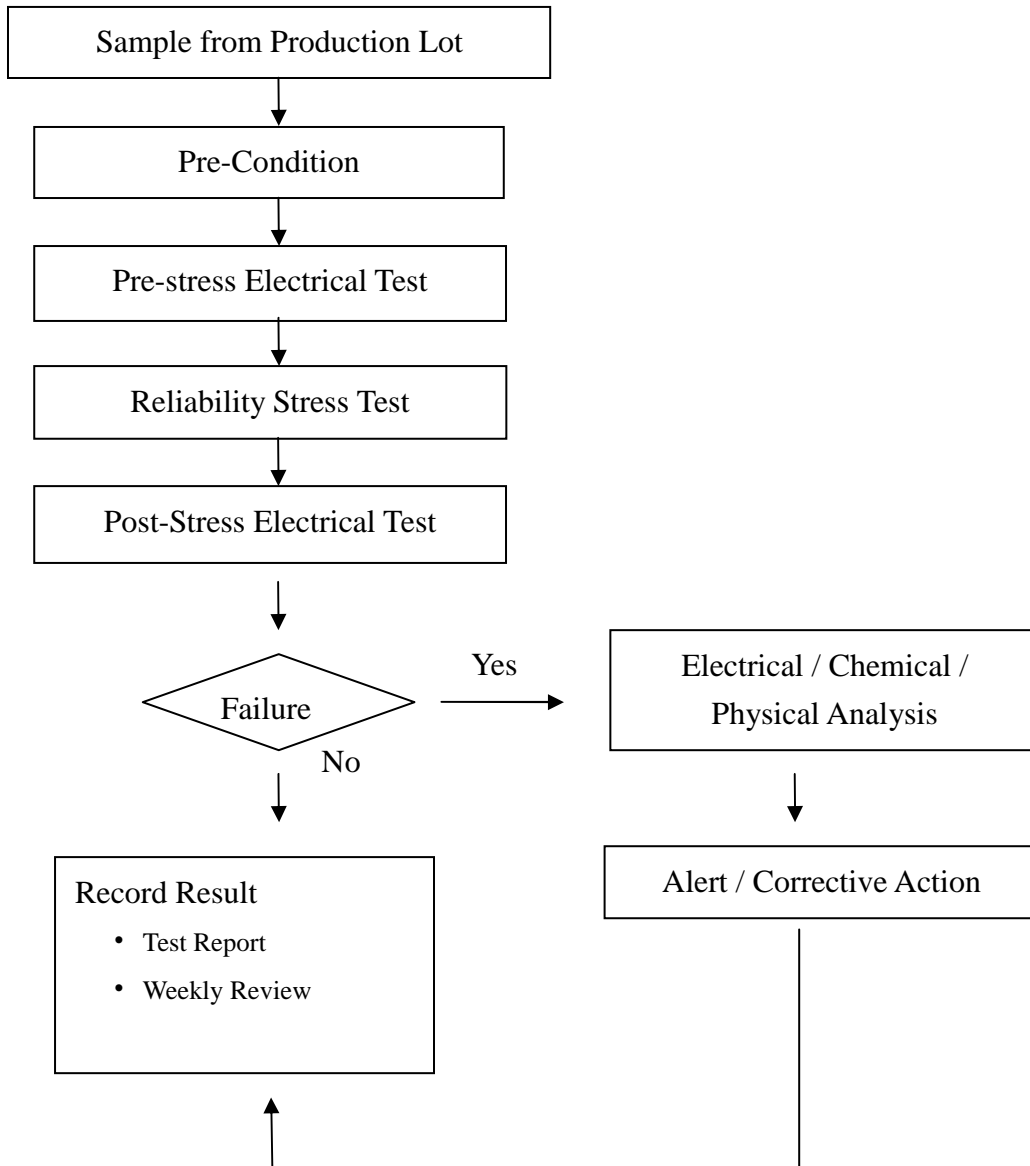



2.1 Pre-Condition (SMD Packages devices only)

This is to simulate the product storage, shipping and customer application environment.

Step 1: Baking 125°C , 24hrs.

Step 2: 85°C / 85%R.H. Soaking 168hrs. (J-STD-020 Level 1)

Step 3: IR Reflow Tmax.= 260°C , 3cycles

2.2 Sampling plan

Based on LTPD = 10% , AC=0

3. Accelerated Life Time Stress Test

3.1 Test Level

- Routine Monitor Qualification
- New Product Qualification
- Engineer / Customer Request Qualification

3.2 Test Result

Test Item	Sample Size	Total Device (hours)	Result	Failure Rate (FITs)	MTTF' (10 ⁶) Devices hrs.
High Temperature Gate Bias(HTGB)	22	22000 hrs	Pass	1186.08	0.84
High Temperature Reverse Bias (HTRB)	22	22000 hrs	Pass	1186.08	0.84

CL = 90% ; Ea = 0.7eV ; Operating Temp. = 70°C

3.3 Test Item Description

3.3.1 High Temperature Gate Bias (HTGB)

- Reference Standard
EIAJ ED-4701 D323
HTGB Operation spec. (QWRAD-7117)
- Condition:
Temperature: Max. Operating Temperature

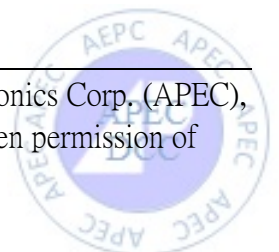



Test Point: 0, 168, 500, 1000 Hours Nominal
Bias: Max. VGS Rating

3.3.2 High Temperature Reverse Bias (HTRB)

- Reference Standard

EIAJ ED-4701 D321

HTRB Operation spec. (QWRAD-7118)

- Condition:

Temperature: Max. Operating Temperature

Test Point: 0, 168, 500, 1000 Hours Nominal

Bias: VS=VG=0V, VD= 80% of Max. BVDSS Rating

4. Environmental & Package Stress Test

4.1 Test Level

- Routine Monitor Qualification
- New Product Qualification
- Engineer / Customer Request Qualification

4.2 Test Result

Test Item	Sample Size	Test Time (hours/ cycles)	Result
HTST	22	1000 hrs.	Pass : 0/22
H3TRB	22	1000 hrs.	Pass : 0/22
THST	22	1000 hrs.	Pass : 0/22
PRCL	22	10K cyc.	Pass : 0/22
TCT	22	1000 cyc.	Pass : 0/22
PCT	22	168 hrs.	Pass : 0/22
TST	22	100 cyc.	Pass : 0/22
HAST	22	96 hrs.	Pass : 0/22

The pre-conditioning (SMD Packages devices only)

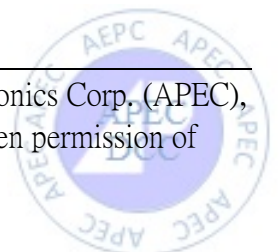

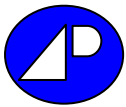

4.3 Test Item Description

4.3.1 High Temperature Storage Test (HTST)

- Reference Standard

EIAJ ED-4701 B111A

HTST Operation spec. (QWRAD-7116)

- Condition:

Temperature: 150°C

Test Point: 0, 1000 Hours Nominal

Bias: no Bias

4.3.2 High Temperature & Humidity Reverse Bias (H3TRB)

- Reference Standard

EIAJ ED-4701 B122A

H3TRB Operation spec. (QWRAD-7111)

- Condition:

Temperature: 85°C

Relative Humidity: 85% R.H.

Test Point: 0, 168, 500, 1000 Hours Nominal

Bias: VS=VG=0V,
VD= 80% of Max. BVDSS Rating up to 100V

4.3.3 Temperature Humidity Storage Test (THST)

- Reference Standard

EIAJ ED-4701 B121

THST Operation spec. (QWRAD-7115)

- Condition:

Temperature: 85°C

Relative Humidity: 85% R.H.

Test Point: 0, 1000 Hours Nominal

Bias: no bias

4.3.4 Power Cycling Test (PRCL)

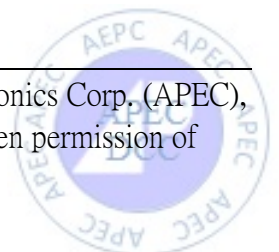

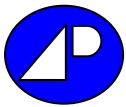

- Reference Standard
EIAJ ED-4701 D322
PRCL Operation spec. (QWRAD-7114)
- Condition:
Temperature: $T_j = \Delta 100^\circ\text{C}$
Test Point: 0, 10000 Cycles Nominal
Bias (Set to give) : $\Delta T = 100^\circ\text{C}$

4.3.5 Temperature Cycling Test (TCT)

- Reference Standard
MIL STD 883E 1010.7
TCT Operation spec. (QWRAD-7113)
- Condition:
Temperature: $T_{\min.} = -65^\circ\text{C}$, $T_{\max.} = 150^\circ\text{C}$, $\Delta T = 215^\circ\text{C}$
Test Point: 0, 1000 cycles Nominal

4.3.6 Pressure Cooker Test (PCT)

- Reference Standard
JESD22-A102C
PCT Operation spec. (QWRAD-7110)
- Condition:
Temperature: 121°C
Relative Humidity: 100% R.H.
Pressure: 2 atm
Test Point: 0, 168 Hours Nominal

4.3.7 Thermal Shock Test (TST)

- Reference Standard
MIL STD 883E 1011.9
TST Operation spec. (QWRAD-7112)
- Condition:
Temperature: $T_{\min.} = -65^\circ\text{C}$, $T_{\max.} = 150^\circ\text{C}$, $\Delta T = 215^\circ\text{C}$
Test Point: 0, 100 Cycles Nominal

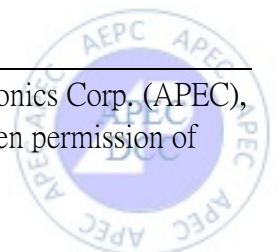



4.3.8 Highly Accelerated Stress Test (HAST)

- Reference Standard

JESD22-A118

- Condition:

Temperature: 130°C

Relative Humidity: 85% R.H.

Pressure: 33.3 psia / 230kPa

Test Point: 0, 96 Hours Nominal

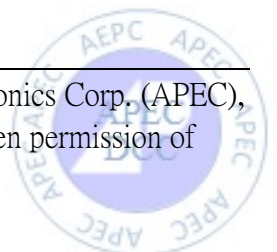

X-ON Electronics

Largest Supplier of Electrical and Electronic Components

Click to view similar products for [MOSFET](#) category:

Click to view products by [Advanced Power](#) manufacturer:

Other Similar products are found below :

[614233C](#) [648584F](#) [MCH3443-TL-E](#) [MCH6422-TL-E](#) [FDPF9N50NZ](#) [FW216A-TL-2W](#) [FW231A-TL-E](#) [APT5010JVR](#) [NTNS3A92PZT5G](#)
[IRF100S201](#) [JANTX2N5237](#) [2SK2464-TL-E](#) [2SK3818-DL-E](#) [FCA20N60_F109](#) [FDZ595PZ](#) [STD6600NT4G](#) [FSS804-TL-E](#) [2SJ277-DL-E](#)
[2SK1691-DL-E](#) [2SK2545\(Q,T\)](#) [D2294UK](#) [405094E](#) [423220D](#) [MCH6646-TL-E](#) [TPCC8103,L1Q\(CM](#) [367-8430-0972-503](#) [VN1206L](#)
[424134F](#) [026935X](#) [051075F](#) [SBVS138LT1G](#) [614234A](#) [715780A](#) [NTNS3166NZT5G](#) [751625C](#) [873612G](#) [IRF7380TRHR](#)
[IPS70R2K0CEAKMA1](#) [RJK60S3DPP-E0#T2](#) [RJK60S5DPK-M0#T0](#) [APT5010JVFR](#) [APT12031JFLL](#) [APT12040JVR](#) [DMN3404LQ-7](#)
[NTE6400](#) [JANTX2N6796U](#) [JANTX2N6784U](#) [JANTXV2N5416U4](#) [SQM110N05-06L-GE3](#) [SIHF35N60E-GE3](#)