

VHF POWER MOSFET

DESCRIPTION:

The **ASI BLF278** is a Dual Common Source N-Channel Enhancement-Mode MOSFET RF Power Transistor, Designed for 175 MHz, 300 W Transmitter and Amplifier Applications.

MAXIMUM RATINGS

I_D	40 A
V_{DSS}	125 V
V_{GS}	± 40 V
P_{DISS}	500 W @ $T_C = 25^\circ\text{C}$
T_J	-65°C to $+200^\circ\text{C}$
T_{STG}	-65°C to $+150^\circ\text{C}$
θ_{JC}	0.35°C/W

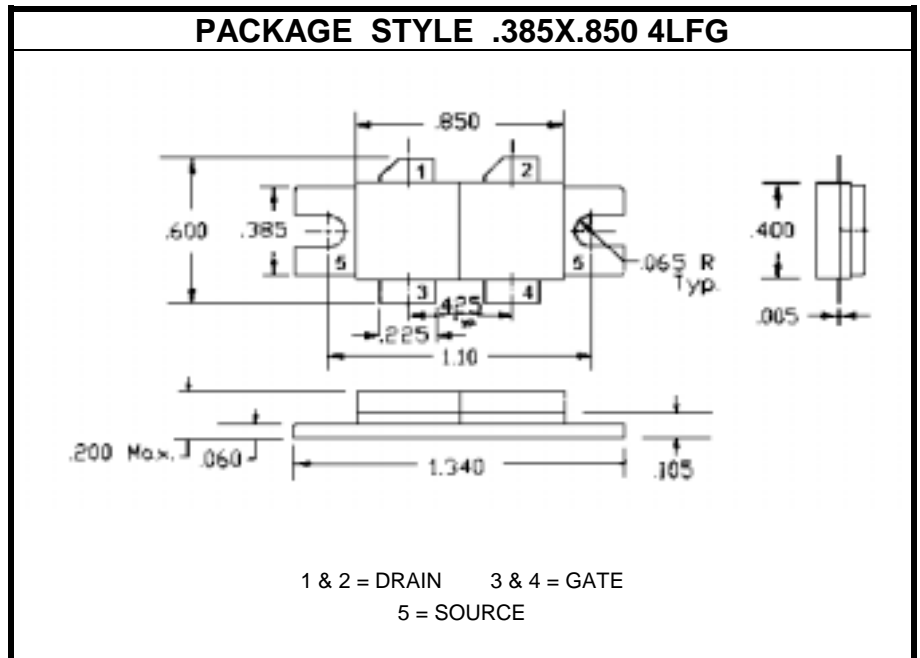

CHARACTERISTICS $T_C = 25^\circ\text{C}$

SYMBOL	TEST CONDITIONS	MINIMUM	TYPICAL	MAXIMUM	UNITS
BV_{DSS}	$I_D = 100$ mA	125			V
I_{DSS}	$V_{DS} = 50$ V $V_{GS} = 0$ V			5.0	mA
I_{GSS}	$V_{DS} = 0$ V $V_{GS} = 20$ V			1.0	μA
$V_{GS(th)}$	$I_D = 100$ mA $V_{DS} = 10$ V	1.0		5.0	V
$V_{DS(on)}$	$I_D = 10$ A $V_{GS} = 10$ V			5	V
g_{fs}	$I_D = 5.0$ A $V_{DS} = 10$ V	5.0			mhos
C_{iss} C_{oss} C_{rss}	$V_{DS} = 50$ V $V_{GS} = 0$ V $f = 1.0$ MHz		350 250 15		pF
G_{ps} η	$V_{DD} = 50$ V $I_{DQ} = 500$ mA $P_{out} = 300$ W $f = 175$ MHz	14 50	16 55		dB %
ψ	$V_{SWR} = 5:1$ AT ALL PHASE ANGLES	NO DEGRADATION IN OUTPUT POWER			

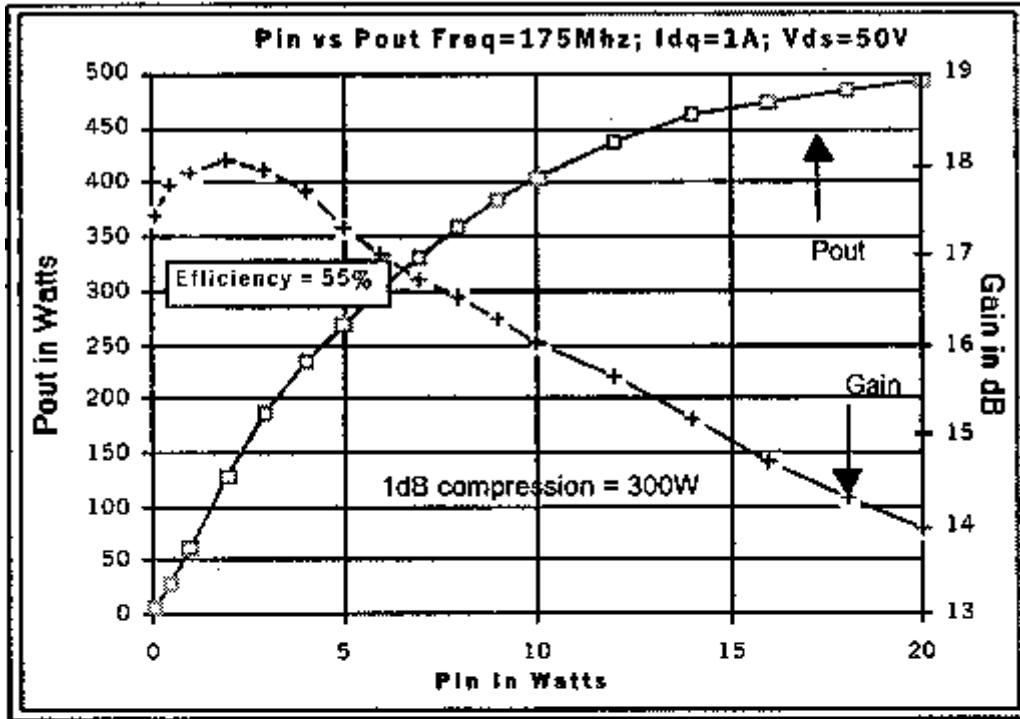
POUT VS PIN GRAPH

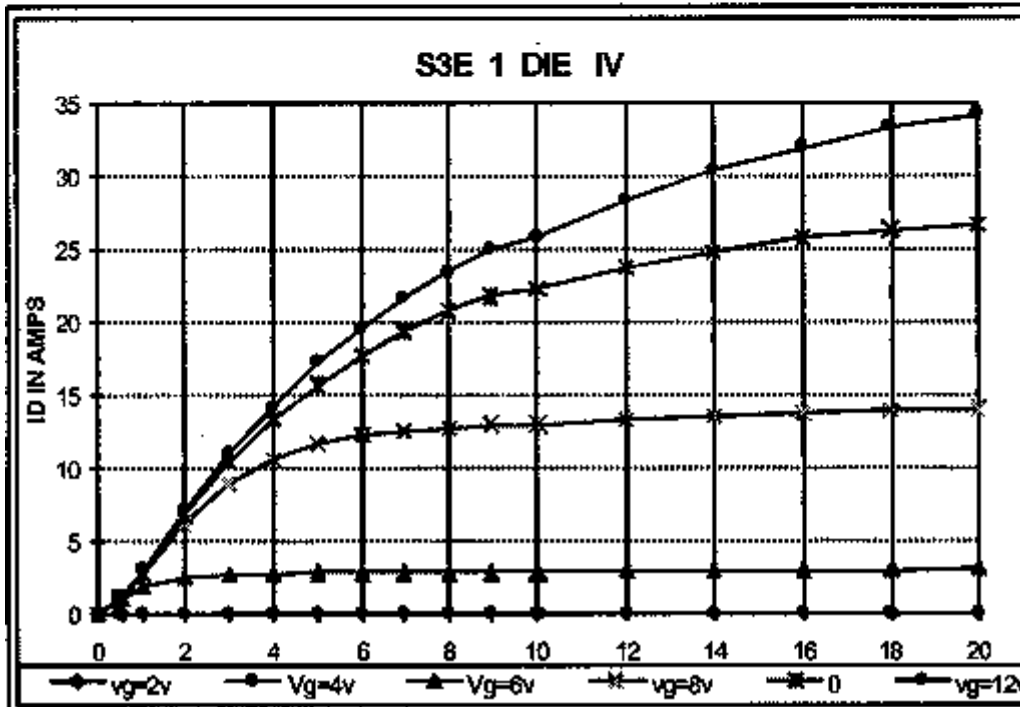

IV CURVE

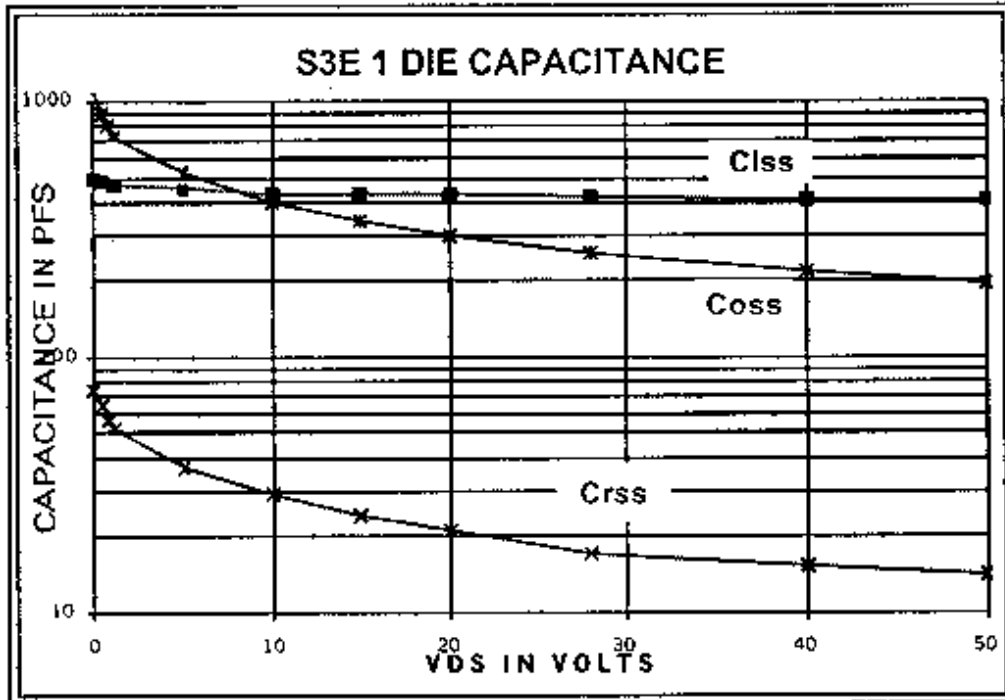
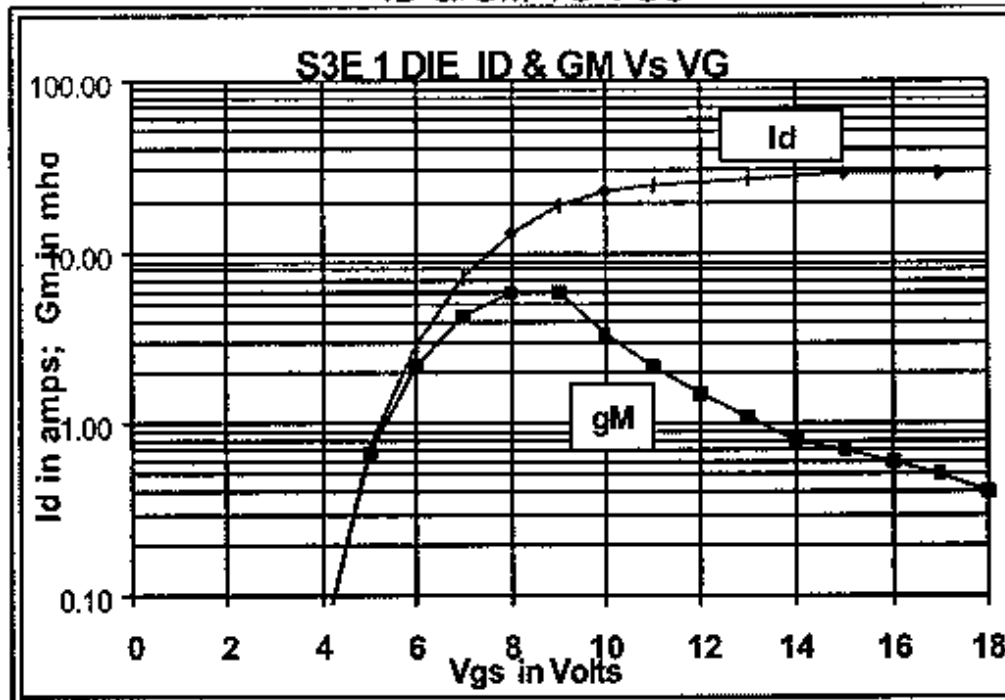

CAPACITANCE VS VOLTAGE

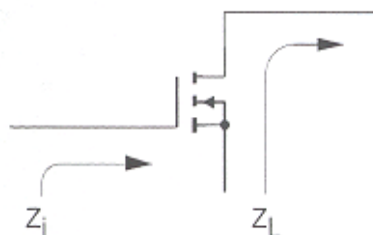
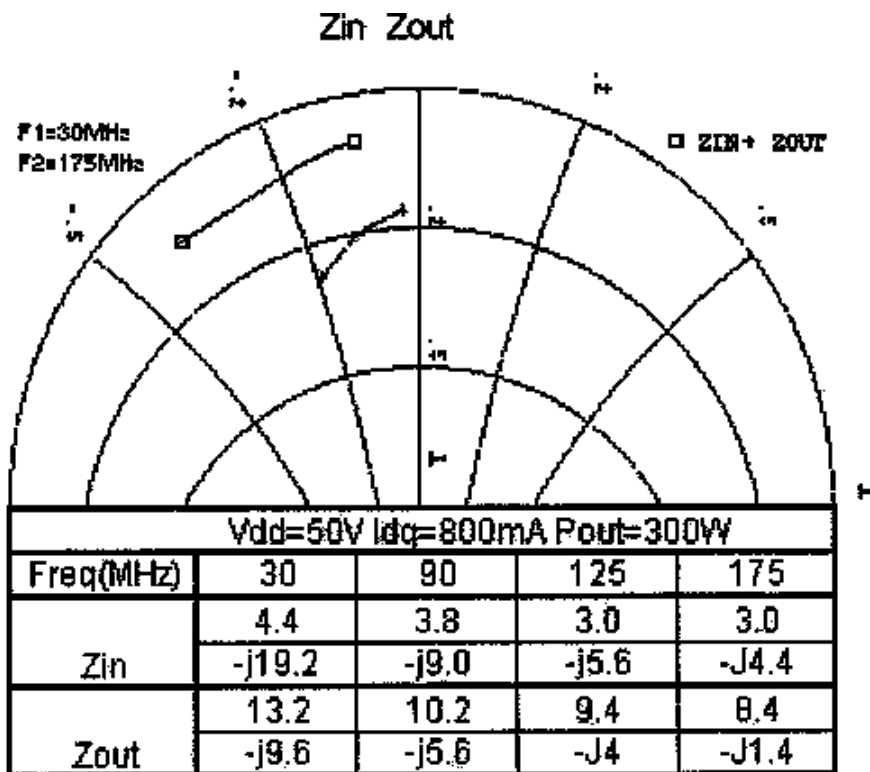
ID & GM VS VGS





ASI RF DEVICES

!
!
!
!
!
!
!

BLF278 (Each side)

S PARAMETERS

VDS=50V, IDQ=400mA

MHZ S MA R 50

! Freq=Mhz	Mag[s11]	Ang[s11]	Mag[s21]	Ang[s21]	Mag[s12]	Ang[s12]	Mag[s22]	Ang[s22]
10.0000	0.83747	-151.063	27.3956	94.1661	0.01705	8.72886	0.58986	-142.841
15.0000	0.84031	-158.633	18.7280	85.9160	0.01628	-0.96378	0.60251	-150.026
20.0000	0.84723	-162.908	13.8120	79.8023	0.01616	-5.92879	0.62064	-153.163
25.0000	0.85287	-165.197	10.8614	74.7640	0.01559	-12.5836	0.64215	-154.551
30.0000	0.86258	-166.662	8.80371	70.1601	0.01546	-14.0670	0.66315	-155.623
35.0000	0.87300	-167.708	7.31926	66.2638	0.01422	-15.2201	0.68657	-156.454
40.0000	0.87885	-168.313	6.20180	62.4688	0.01355	-21.7797	0.71127	-156.911
45.0000	0.88779	-168.889	5.33086	59.0794	0.01310	-22.1195	0.73435	-157.702
50.0000	0.89448	-169.583	4.62723	55.9900	0.01266	-23.4078	0.75375	-158.189
55.0000	0.90299	-170.078	4.04324	53.3573	0.01120	-24.5177	0.77229	-158.969
60.0000	0.90882	-170.598	3.57797	50.8563	0.01064	-28.1139	0.79081	-159.728
65.0000	0.91539	-170.945	3.17462	48.6080	0.01003	-27.6968	0.80771	-160.420
70.0000	0.92222	-171.452	2.83402	46.2563	0.00986	-29.2237	0.82084	-160.996
75.0000	0.92639	-171.760	2.54871	44.4224	0.00850	-28.0810	0.83260	-161.649
80.0000	0.93150	-171.996	2.30691	42.6712	0.00817	-32.6804	0.85175	-162.239
85.0000	0.93589	-172.523	2.09657	40.9265	0.00775	-31.0442	0.85892	-163.014
90.0000	0.94214	-172.742	1.90687	39.4646	0.00770	-29.1611	0.86738	-163.709
95.0000	0.94487	-173.065	1.74744	38.0245	0.00655	-26.9029	0.87574	-164.155
100.000	0.94613	-173.318	1.60882	36.9997	0.00624	-26.4073	0.88477	-164.816
115.000	0.95430	-174.193	1.27120	33.7465	0.00494	-22.0092	0.90443	-166.111
130.000	0.96370	-174.772	1.03082	31.0149	0.00405	-8.62124	0.91904	-167.411
145.000	0.96577	-175.445	0.85053	28.5008	0.00345	15.2775	0.93060	-168.612
160.000	0.97354	-176.090	0.71706	26.9099	0.00406	18.2489	0.94317	-169.671
175.000	0.97232	-176.684	0.60905	24.9097	0.00396	34.6921	0.94921	-170.411
190.000	0.97373	-176.941	0.52601	23.6811	0.00442	60.9895	0.95349	-171.191
205.000	0.97665	-177.305	0.45427	22.8048	0.00512	67.5609	0.96082	-171.773
220.000	0.98025	-177.663	0.39996	22.0539	0.00648	73.2592	0.96150	-172.405
235.000	0.98177	-178.142	0.35799	21.1790	0.00691	76.8913	0.96810	-172.973
250.000	0.98017	-178.354	0.31865	20.4965	0.00758	81.4188	0.97058	-173.557
265.000	0.98152	-178.702	0.28756	20.6230	0.00858	83.5928	0.97094	-173.979
280.000	0.98349	-178.836	0.26320	19.8483	0.00980	86.7674	0.97233	-174.400
295.000	0.98441	-179.154	0.23858	19.3588	0.01042	86.3890	0.97668	-174.574
310.000	0.98361	-179.471	0.21519	19.1929	0.01098	89.5518	0.97479	-175.077
325.000	0.98561	-179.718	0.19819	18.4377	0.01229	91.7969	0.97746	-175.505
340.000	0.98501	-179.869	0.18099	19.6530	0.01308	92.2737	0.97940	-175.953
355.000	0.98692	179.859	0.16810	18.6449	0.01349	91.3383	0.98188	-175.897
370.000	0.98555	179.752	0.16137	20.5312	0.01418	91.9241	0.98041	-176.189
385.000	0.98822	179.511	0.15027	19.7641	0.01560	92.4536	0.98073	-176.588
400.000	0.98829	179.336	0.13766	20.8798	0.01620	92.0722	0.98261	-176.808
415.000	0.98773	179.166	0.12974	19.0245	0.01724	93.8917	0.98610	-177.114
430.000	0.98886	178.743	0.11997	19.9215	0.01812	94.8087	0.98610	-177.171
445.000	0.98952	178.735	0.11662	19.8737	0.01928	93.0825	0.98659	-177.573
460.000	0.99223	178.652	0.10659	20.2039	0.02015	93.6649	0.98513	-177.605
475.000	0.99217	178.525	0.10291	22.3386	0.02032	93.8780	0.98815	-177.706
490.000	0.99093	178.328	0.09499	23.5854	0.02087	95.3520	0.98734	-178.180

ADVANCED SEMICONDUCTOR, INC.

7525 ETHEL AVENUE • NORTH HOLLYWOOD, CA 91605 • (818) 982-1202 • FAX (818) 765-3004

REV. B

5/7

Specifications are subject to change without notice.



505.000	0.98904	177.900	0.09288	24.3178	0.02253	95.5649	0.98953	-178.261
520.000	0.98753	177.826	0.08876	24.1062	0.02288	95.4464	0.98714	-178.215
535.000	0.98584	177.697	0.08378	27.3328	0.02415	97.1222	0.99400	-178.628
550.000	0.99250	177.572	0.08247	29.3983	0.02494	96.0530	0.99166	-178.778
565.000	0.99413	177.257	0.07822	27.2453	0.02571	97.8381	0.99387	-178.902
580.000	0.99245	177.031	0.07467	27.8200	0.02530	97.2712	0.98799	-179.373
595.000	0.98715	176.735	0.07101	32.0492	0.02706	96.9025	0.98797	-179.626
610.000	0.98797	176.550	0.06786	31.2308	0.02796	96.6285	0.98858	-179.785
625.000	0.98881	176.455	0.06254	32.4249	0.02841	97.4609	0.99071	-179.900
640.000	0.98908	176.285	0.06360	36.9496	0.02939	97.4627	0.98654	-179.575
655.000	0.98753	176.016	0.06277	37.0072	0.02935	98.2586	0.98868	-179.929
670.000	0.98643	175.910	0.06004	40.0063	0.03090	98.6724	0.99076	179.932
685.000	0.98840	175.782	0.06111	37.8170	0.03147	99.1738	0.98962	179.695
700.000	0.98846	175.800	0.05886	44.3227	0.03158	100.273	0.99068	179.587
710.000	0.98530	175.570	0.05697	43.3396	0.03291	100.088	0.99163	179.411

! Unit: BLF278
! S1E 1+1Die in an AR pkg.
!
! Meas: 110L#24
! Vds=50Vdc, Idq=400ma, Vgsth=4.10Vdc, wafer=00712-17
!

SPICE MODEL

```

*HIGH POWER, HIGH FREQUENCY, RF N-CHANNEL VERTICAL DMOS MOSFET
*TO GENERATE S PARAMETER MATCHING DATA SHHET, SET VG = 4.3 V FOR IDQ = 455 Ma
*MODEL APPLICABLE FOR BLF278
*NOTE:- HP/EESOF USES 'GATE DRAIN SOURCE' ORDER
*
.SUBCKT BLF278/PF      20 10 30
LG      10      11      0.29n
RGATE   11      12      0.73
CG      10      30      0.01P
CRSS    12      17      15.3P
CISS    12      14      490P
LS      14      30      0.2N
CS      14      30      0.02P
LD      17      20      0.1N
CD      20      30      2.9P
R_RC    16      17      2.2
C_RC    14      16      31.2P
MOS     13      12      14      14 BLF278 MOS L = 1.1 U W = 0.778 ;D G S B LEVEL1
JFET    17      14      13      BLF278 JF          ;D G S
DBODY   14      17      BLF278 DB          ;P N

MODEL BLF278 MOS      NMOS      (VTO =4 KP = 0.9 E-5 LAMBDA = 0.15 RD = 0.065 RS = 0.07)
MODEL BLF278 JF      NJF      (VTO = 6.8 BETA = 1 LAMBDA =1)
MODEL BLF278 DB      D      (CJO = 1100 P RS = 0.25 VJ = 0.6 M = 0.4 BV = 13)
ENDS
S

```

BIASING ASI RF TRANSISTORS

ASI RF Mosfets are enhancement mode devices. In order to cause drain current to flow, positive voltage of about 3 V needs to be applied to the Gate terminal. The higher the gate voltage applied the higher the drain current. The Mosfet transistor drain current will change with temperature. As the temperature goes up, so will the drain current. In order to prevent a runaway situation, the gate voltage needs to have negative temperature coefficient. The following circuit describes a means to achieve a $-2\text{mv}/^\circ\text{C}$ coefficient at the gate terminal.

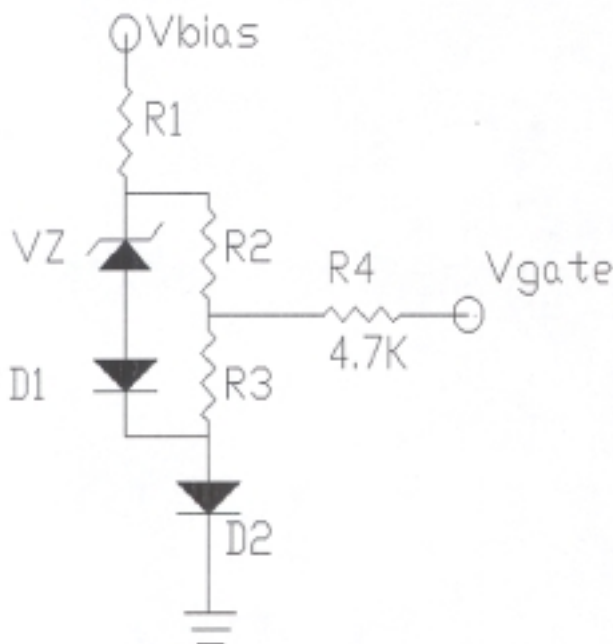

$$V_g = V_d + (V_z + V_d) * (R_3 / (R_3 + R_2))$$

$$\Delta V_g = \Delta V_d + (\Delta V_z + V_d) * (R_3 / (R_3 + R_2))$$

$$\Delta V_z = -\Delta V_d$$

$$\Delta V_g = -\Delta V_d = -2\text{mv}/^\circ\text{C}$$

- The temperature coefficient of a 6.8V zener is about $+2\text{mv}/^\circ\text{C}$ and the diode is about $-2\text{mv}/^\circ\text{C}$
- The gate of a transistor draws no current, so there is no current flow in R4. R4 is used as a RF isolation resistor.
- R1 is adjusted to cause about 10ma of current flow into the circuit.
- R2 and R3 can be a potentiometer to adjust for the desired gate voltage. The total value of R2 and R3 should be high enough so that the current drawn in R2 and R3 is substantially less than 10ma. Recommend around 2ma.

X-ON Electronics

Largest Supplier of Electrical and Electronic Components

Click to view similar products for [RF MOSFET Transistors](#) category:

Click to view products by [Advanced Semiconductor](#) manufacturer:

Other Similar products are found below :

[MRF492](#) [MRFE8VP8600HR5](#) [ARF1511](#) [ARF465BG](#) [BF 2030 E6814](#) [BLF861A](#) [MRF150J](#) [DU1215S](#) [DU28200M](#) [UF28100M](#) [DU2820S](#)
[MHT1008NT1](#) [MMRF1014NT1](#) [MRF426](#) [ARF468BG](#) [MAPHST0045](#) [MRFE6VP61K25NR6](#) [DU2860U](#) [VRF152GMP](#) [MRFE6VP5300NR1](#)
[BF2040E6814HTSA1](#) [MRFE6VP5150GNR1](#) [LET9060S](#) [MRF136Y](#) [BF999E6327HTSA1](#) [SD2931-12MR](#) [BF998E6327HTSA1](#)
[AFV10700HR5](#) [MRF141](#) [MRF171](#) [MRF172](#) [MRF174](#) [QPD1020SR](#) [BF 1005S E6327](#) [MRF134](#) [MRF136](#) [MRF137](#) [MRF141G](#) [MRF151](#)
[MRF151A](#) [MRF151G](#) [MRF157](#) [MRF158](#) [MRF160](#) [MRF171A](#) [MRF173](#) [MRF177](#) [UF2840G](#) [TGF3021-SM](#) [ARF1510](#)