



maxiFLOW™ Heat Sink for Quarter Brick DC-DC Converter

ATS PART # ATS-1099-C1-R0

Features & Benefits

- » High performance maxiFLOW™ design features less pressure drop and more surface area that maximizes the effective convection (air) cooling
- » Hole pattern fits standard quarter power brick modules
- » Pre-assembled with Chomerics T766 phase change material
- » Heat sink assembly packaged with 3 sets of screws (M3 Philips Pan Head) at 5, 6 and 8 mm lengths

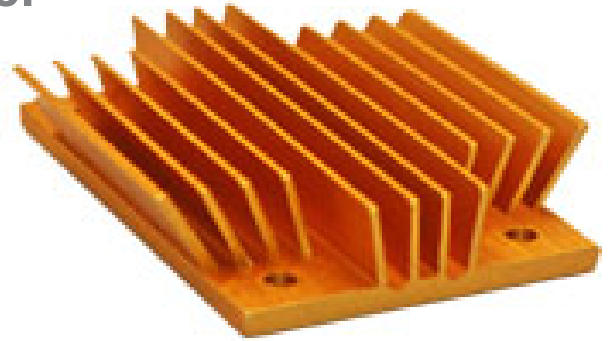

**Image is for illustration purposes only.*

Assembly Part Number	Length (mm)
4 Screws per Set	
ATS-1099-C2-R0	5
ATS-1099-C3-R0	6
ATS-1099-C4-R0	8

Thermal Performance

AIR VELOCITY		THERMAL RESISTANCE	
FT/MIN	M/S	°C/W (UNDUCTED FLOW)	°C/W (DUCTED FLOW)
200	1.0	4.3	2.2
300	1.5	3.0	
400	2.0	2.4	
500	2.5	2.1	
600	3.0	1.9	
700	3.5	1.8	
800	4.0	1.7	

Product Details

DIMENSION A	DIMENSION B	DIMENSION C	DIMENSION D	DIMENSION E	DIMENSION F	INTERFACE MATERIAL	FINISH
58.0 mm	37.0 mm	11.4 mm	48.2 mm	26.2 mm	47.2 mm	CHOMERICS T766	GOLD ANODIZED

NOTES:

- 1) Thermal performance data are provided for reference only. Actual performance may vary by application.
- 2) ATS reserves the right to update or change its products without notice to improve the design or performance.
- 3) Standard lead time is 4-6 weeks ARO.
- 4) Contact ATS to learn about custom options available.
- 5) Dimension C = heat sink height from bottom of the base to the top of the fin field.
- 6) Dimension D = Fin Tip to Fin Tip
- 7) Dimension E = Hole Width
- 8) Dimension F = Hole Length

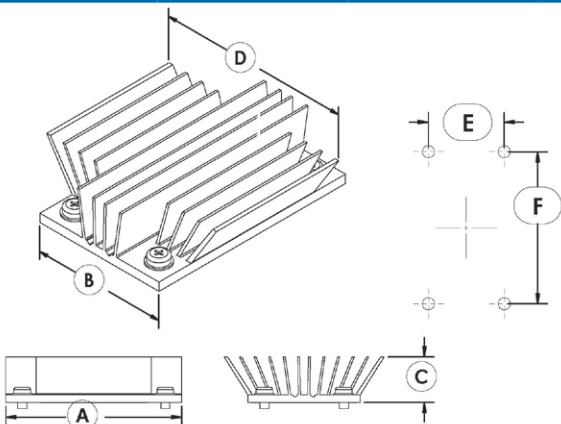

ATS ADVANCED THERMAL SOLUTIONS, INC.
Innovations in Thermal Management®

For further technical information, please contact Advanced Thermal Solutions, Inc.

89-27 ACCESS ROAD, NORWOOD, MA 02062 USA | T: 781.769.2800 F: 781.769.9979 | WWW.QATS.COM

REV4_0117

X-ON Electronics

Largest Supplier of Electrical and Electronic Components

Click to view similar products for [Heat Sinks](#) category:

Click to view products by [Advanced Thermal Solutions](#) manufacturer:

Other Similar products are found below :

[581102B00000G](#) [656-15ABPE](#) [657-20ABPNE](#) [7020B-TC12-MTG](#) [73452PPBA](#) [7G0011A](#) [PF720G](#) [A22-4026](#) [120-1873-007](#) [HAH10L](#)
[HAH15L](#) [1542616-1](#) [HS-2506-F1](#) [HS-87M0-F2](#) [218-40CTE3](#) [231-69PAB-15V](#) [25-7520](#) [SW50-4G](#) [231-75PAB-13V](#) [231-75PAB-15V](#) [253-](#)
[122ABE-22](#) [PSC22CB](#) [HAF10L](#) [HAQ10T](#) [D10100-28](#) [BDN183CBA01](#) [3-21053-4](#) [32438](#) [TX0506-1B](#) [TX1806B](#) [LAE66A3CB](#) [WA-DT2-](#)
[101E](#) [511-3U](#) [73381PPBA](#) [73403PPBA](#) [7G0047C](#) [COMX-440-HSP](#) [510-12M](#) [D10650-40T5](#) [V8511 Y](#) [APF40-40-13CB/A01](#)
[780653U04500G](#) [ATS-54310K-C2-R0](#) [FK 216 CB SA](#) [FK 231 SA 220](#) [648-51AB](#) [657-20ABPESC](#) [2341BG](#) [679-25AG](#) [FK 212 CB SA](#)