

ARK-6610/6620

Compact Chassis for
Mini-ITX Motherboard



Features

- ARK-6610 with one front I/O expansion slot
- Various cut-outs for COM/DVI/LVDS,USB,S/C-video
- Shockproof drive bay for slim ODD and 3.5" HDD
- Bottom door to access CF card or Mini-PCIe card
- Optional equipped FLEX power supply



Specifications

		ARK-6610	ARK-6620
Disk Drive Bay	Slim Optical Drive	1	-
	3.5" (internal)	1	1
I/O Interface	COM	5	2
	USB	2	-
	DVI/LVDS	2	1
	S/C-Video	1	1
	WLAN Antenna	1	1
Cooling	Fan	1 (9 cm / 52.5 CFM)	2 (6 cm / 27.7 CFM, each)
	Air Filter	Yes	Yes
Miscellaneous	LED Indicators	Power, HDD, temperature	Power, HDD, temperature
	Control	Power switch	Power switch
Environment	Operating	Non-operating	Non-operating
	Temperature	0 ~ 40° C (32 ~ 104° F)	-20 ~ 60° C (-4 ~ 140° F)
	Humidity	10 ~ 85%, 40° C, non-condensing	10 ~ 95%, @ 40° C, non-condensing
	Vibration (5 ~ 500 Hz)	1 Grms	2 G
	Shock	10 G (with 11ms duration, half sine wave)	30 G
Physical Characteristics	Dimensions (W x H x D)	250 x 156 x 253 mm (9.8" x 6.1" x 10")	272 x 88 x 232 mm (10.7" x 3.5" x 9.1")
	Weight	4.76 kg (10.47 lb)	3.49 kg (7.68 lb)

Front View

ARK-6610



Inside View

ARK-6610

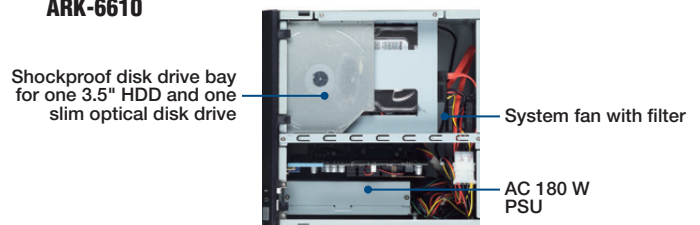

ARK-6620



ARK-6620

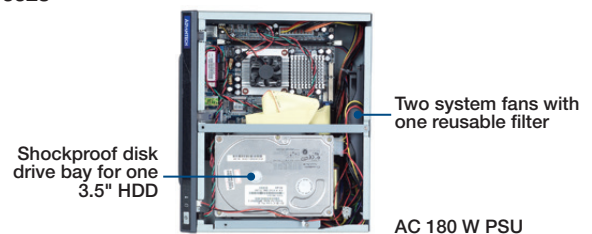

Dimensions

Unit: mm [inch]

ARK-6610

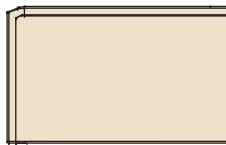
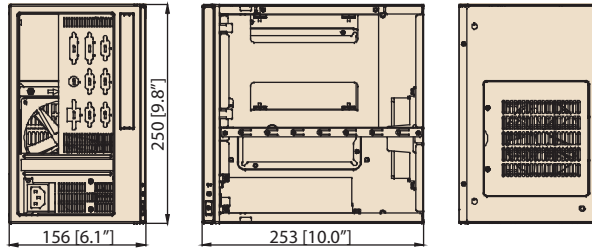

ARK-6620

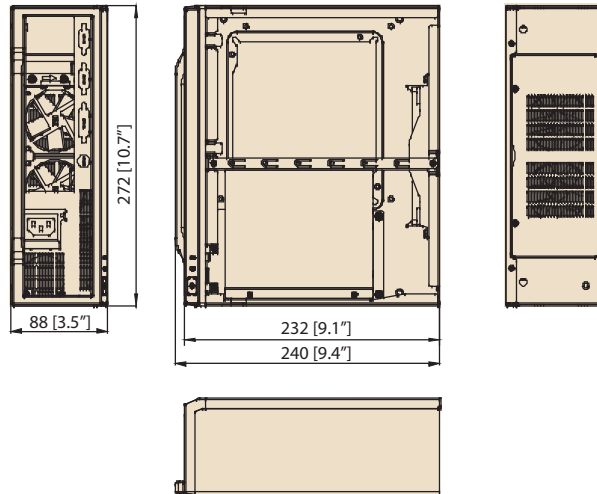

Installation

ARK-6610

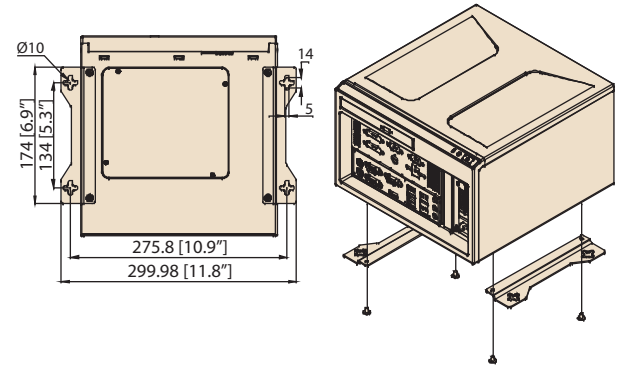

ARK-6620

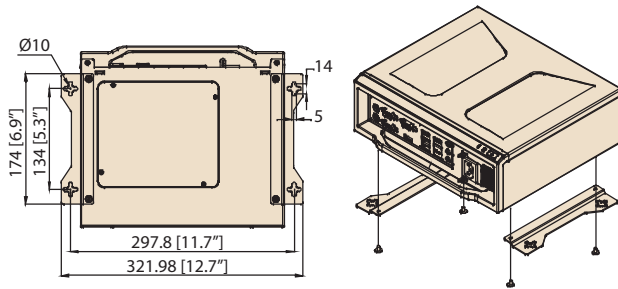

Chassis Ordering Information

Part Number	Power Supply
ARK-6610-00XBE	-
ARK-6610-18ZBE	1757000878
ARK-6620-00XBE	-
ARK-6620-18ZBE	1757000878

Optional Accessories

Part Number	Description
1750002561	52.5 CFM, 92 x 92 x 25.4 mm system cooling fan (For ARK-6610)
1750006419	27.7 CFM, system cooling fan 60 x 60 x 13 mm (For ARK-6620)
98R2662001E	VESA mounting kit for ARK-6620

X-ON Electronics

Largest Supplier of Electrical and Electronic Components

Click to view similar products for [Modules Accessories](#) category:

Click to view products by [Advantech](#) manufacturer:

Other Similar products are found below :

[7010-0001](#) [AX98219](#) [A1UL8RISER](#) [F1UJPMICRISER](#) [FHW1U16RISER](#) [20-101-0440](#) [2828736-1](#) [MBCDROM](#) [AX61221TM](#) [VM-105](#)
[EA CARREDIPTFT02](#) [RK-210E-B](#) [E226171106](#) [88606200030E](#) [SI-HDMI-EDID-EM](#) [MIC-75M13-00A1E](#) [FPM-1000T-SMKE](#) [AMK-](#)
[R004E](#) [96FMCF-ST2ADAPTER1](#) [AHWKPTP12GBGB](#) [AXXSTCPUCAR](#) [FPK-07-R10](#) [Mini Din 6P to 6P HARNESS](#) [FPF1320 POWER](#)
[MULTIPLEXER CARRIER](#) [881261510A0E](#) [AXXP3SWX08080](#) [conga-B7XD/CSP-Cu-B](#) [881281021A0E](#) [HFT for mounting KIT](#)
[FN928X_FN929X](#) [BB-MH112-1A](#) [15100600](#) [9-5000-1116](#) [BKCMCR1ABB](#) [70763](#) [98R3612003E](#) [881261910A0E](#) [106897](#) [48222R](#)
[BREAK OUT BOARD 20](#) [4D ARDUINO ADAPTOR SHIELD II](#) [20926110901](#) [PYCASE GREEN](#) [PYCASE BLUE](#) [FP15072_ZORYA-SC-](#)
[HEKLA](#) [20952000004](#) [20953000007](#) [DP-DVI-R10](#) [575-BBIS](#) [RACK-220GW/A130B](#) [492-BBKM](#)