

ARK-2151V

In-Vehicle Full HD NVR w/4 PoE Ports 4th Gen. Intel® Core i5 4300U / Celeron 2980U SoC Fanless Box PC



Features

- Intel® Celeron 2980U 1.6GHz / Core i5-4300U 1.9 GHz SoC
- 4 PoE Ports to Support Mainstream IP Cameras
- Diversity Communication Abilities, ex. WWAN, WLAN
- Built-in GPS and G-Sensor for GIS application
- Intelligent Vehicle Power Ignition
- 9 ~ 36 V_{DC}* Wide Power Input w/isolation
- 1 x Removable 2.5" drive bay
- Supports iManager, SUSIAccess and Embedded Software APIs

Specifications

		ARK-2151V-S6A1E	ARK-2151V-S9A1E
Processor System	CPU	Intel Celeron 2980U Dual Core	Intel i5-4300U Dual Core
	Frequency	1.6 GHz	1.9 GHz
	L3 Cache	2 MB	3 MB
	BIOS	AMI EFI 128 Mbit	
Memory	Technology	DDR3L 1333 MHz	DDR3L 1600 MHz
	Max. Capacity	8 GB	
	Socket	1 x 204-pin SO-DIMM	
Graphics	Chipset	HD Graphics	GT2-4400 Graphics
	Graphic Engine	DirectX11.1, OpenGL 4.0, and OpenCL 1.2	
	VGA	Full AVC/VC1/MPEG2 HW Decode	
	HDMI	Up to 1920 x 1200 with 60 Hz, 154 MHz pixel clock rate	
Audio	Main System	Lockable HDMI connector, up to 4K at 24 Hz	
Ethernet	LAN #1	Realtek ALC888S, High Definition Audio (HD), Line-in, Line out, Mic-in	
	LAN #2	10/100/1000 Mbps Intel I218 GbE, support Wake on LAN	
I/O Interface	Power over Ethernet, PoE	10/100/1000 Mbps Intel I210-IT, support Wake on LAN	4 x 10/100 Mbps - 4ports full-load, IEEE802.3af Class 2 (7Watt) - 2ports full-load, IEEE802.3af Class 3 (15.4Watt)
	Serial Ports	N/A	2x non-isolated RS-232/422/485 with auto flow control
	CANBus	2x isolated RS-232/422/485 with auto flow control (3KV isolation)	2x non-isolated RS-232/422/485 with auto flow control
	USB Interface	Option, 2ch CANBUS 2.0A/B (1xCOM will be replaced)	
	GPIO	2 x USB 2.0 & 2 x USB3.0	
Other	GPS	6 x DI & 2 x DO w/ 3KV isolation	
	G-Sensor	Input Voltage: 0 to 30 V _{DC} , Output Current: Max. 500 mA per channel On-state Voltage: 24 V _{DC} nominal, open collector to 30 V _{DC}	
	Watchdog timer	On board standalone GPS, support GPS, GLONASS and QZSS signals	
Expansion	Mini PCIe #1	On board high resolution G-Sensor, up to 13-bit resolution at ±16g	
	Mini PCIe #2	255-level timer interval, setup by software	
	Mini PCIe #3/4	Full-size Mini PCIe w/SIM holder (PCIe, USB, SATA interface)	
Storage	2.5" Drive Bay	Half-size Mini PCIe (PCIe interface)	
	mSATA	2 x Full-size Mini PCIe w/SIM holders (USB interface)	
Software Support	Microsoft Windows	1 x removable 2.5" drive bay (Standard 9.5mm height, 15mm height support by project)	
	Linux	Leverage MiniPCIe #1 slot	
Power Requirement	Power Type	WES8, WES7, Windows 8, Windows 7	
	Power Input Voltage*	Support by project	
	Vehicle Power Ignition	ATX/AT	
	Power Consumption	9 ~ 36 V _{DC} w/isolation	26W (Typical), 46W (Max)
Mechanical	Construction	Selectable boot-up & shut-down voltage, on/off delay time	
	Mounting	26W (Typical), 46W (Max)	
	Dimensions (W x H x D)	1.5 KV Isolated	
Environment	Operating Temperature	Aluminum housing, Silver	
	Storage Temperature	Din-Rail mounting, Desk/wall-mounting, VESA mounting	
	Relative Humidity	264.5 x 75.1 x 133.0 mm (10.41" x 2.96" x 5.24")	
	Vibration/Shock	With extended temperature peripherals: -20 ~ 60° C with 0.7m/s air flow With standard temperature peripherals: 0 ~ 45° C with 0.7m/s air flow	
Regulation	EMC	95% @ 40° C (non-condensing)	
	Safety	With mSATA/SSD: IEC 60721-3-5 Class 5M3	
	In-Vehicle Power	CE/FCC Class A, CCC, BSMI	

* Power Input Constraint at low voltage: 9-10.9V.

Dimensions

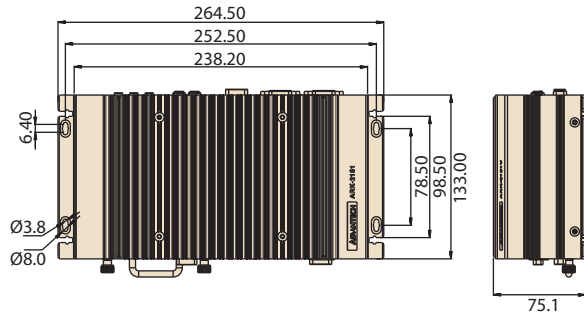

DIN Rail

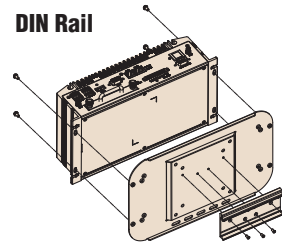

Unit: mm

VESA mount

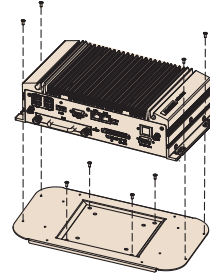

Wall mount

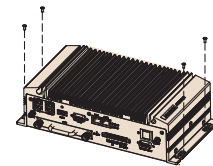

ARK-2151V-S6A1E External I/O Mechanical Layout/Drawing

Front Panel

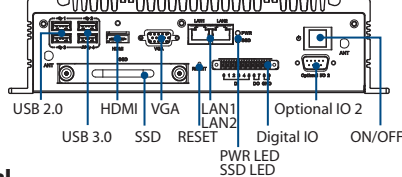

Rear Panel

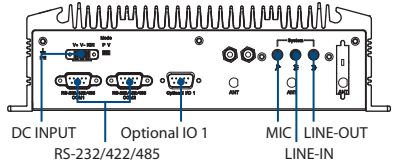

ARK-2151V-S9A1E External I/O Mechanical Layout/Drawing

Front Panel

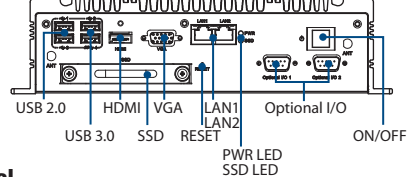

Rear Panel

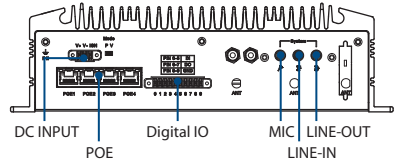

Ordering Information

Part Number	Intel CPU	RAM	2.5" Drive	mSATA	Display	GbE	PoE	USB	DIO	COM	MiniPCIe	SIM Holder	Power Input	Operating Temperature
ARK-2151V-S6A1E	Intel Celeron 2980U 1.6 GHz	Up to 8GB	1	1	1 x HDMI 1 x VGA	2	N/A	2 x USB2.0 2 x USB3.0	6Di 2Do	4 2	3 x Full Size 1 x Half Size	3	9 ~ 36 V _{DC}	-20 ~ 60° C
ARK-2151V-S9A1E	Intel i5-4300U 1.9 GHz													

Packing List

Part Number	Description
-	1 x ARK-2151 Unit
-	1 x Driver/Utility CD/Manual
-	1 x User Manual (Simplified Chinese)
165200049	3-pole phoenix power block 3.81mm
1750001782	1 x GPS antenna Active with 5M SMA cable
1652003235	10-Pin DIO plug in block

Optional Items

Part Number	Description
96PSA-A120W19T2	AC-to-DC Adapter
1702002600	Power Cable 3-pin 180cm, USA type
1702002605-02	Power Cable 3-pin 183cm, Europe type
1700018704	Power Cable 3-pin 183cm, UK type
AMK-V004E	VESA mounting kit
AMK-R004E	DIN-rail mounting kit

Embedded OS

Part Number	Description
2070013560	ARK-2151V-S6A1E WES7 E OS image
2070013568	ARK-2151V-S9A1E WES7 E OS image
2070013599	ARK-2151V-S6A1E WE8S OS image
2070013600	ARK-2151V-S9A1E WE8S OS image
2070014978	ARK-2151V WES7 P OS image (10MUI, 64bit)
2070014995	ARK-2151V Win10 IoT Enterprise OS image (US, 64bit)

*Default BIOS is supported for 64-bit OS installation, BIOS 32-bit OS is supported by project

X-ON Electronics

Largest Supplier of Electrical and Electronic Components

Click to view similar products for [Embedded Box Computers](#) category:

Click to view products by [Advantech](#) manufacturer:

Other Similar products are found below :

[tBOX312-870-FL-i7-DC](#) [tBOX313-835-FL-RJ-DC](#) [UPOS-3150-R0W0E](#) [ARK-20-S8A1E](#) [R2224WTTYSR](#) [BXNUC9i5QNX](#)
[BXNUC9i5QNX1](#) [BKNUC9V7QNX](#) [BKNUC9V7QNX1](#) [2-A0DF-2001](#) [BKCMB1ABB](#) [BKCMB1ABA](#) [EM3000-3845-8-128-WL-U-1](#)
[TANK-870AI-i5/8G/2A-R10](#) [PRFE21000038](#) [EM5000-I3-8-128-WL-W7-1](#) [EM3000-3845-8-128-WL-W7-1](#) [PRFE21000039](#) [AMOS-825-](#)
[1Q10A1](#) [UPS-EDAI-X70864-U01-DC01](#) [UPX-EDGEI7-A10-1664-F01](#) [MXE-211/M8G](#) [PXIe-3985/M16G](#) [PXIe-3987/M16G/SSD](#) [AIMB-](#)
[T1215DA-00Y0E](#) [AIMB-T12315A-00Y0E](#) [AMAX-5580-54000A](#) [APAX-5580-474AE](#) [ARK-6322-Q0A2E](#) [DS-100GF-S8A1E](#) [DS-100GL-](#)
[S8A1E](#) [EPC-R4680CQ-XAA1E](#) [ESRP-CSS-UNO2484](#) [ITA-1611-10A1E](#) [ITA-1711-10A1E](#) [MIC-720AI-00A1](#) [UNO-247-J1N1AE](#) [UTX-](#)
[3115FS-S6A2E](#) [AMI220AF-4L-7500](#) [ELIT-1200](#) [AIE100-903-FL](#) [eBOX626-311-FL](#) [EBOX671-517-FL-DC](#) [MVS900-511-FL](#) [AMS200](#) [SE-](#)
[92-I7](#) [SI-606](#) [SI-60E](#) [TANK-760-HM86i-i5/4G-R10](#) [BKCM8i7CB8N](#)