

WISE-710

ARM Cortex™-A9 Industrial Gateway with 2 x LAN, 3 x COM Ports, 4 x DI/DO

NEW

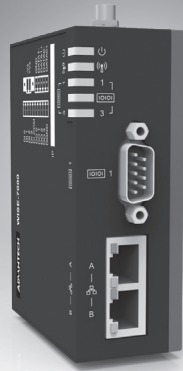

Features

- NXP® ARM® Cortex™-A9 i.MX6 processor
- 1 GB DDR3L RAM and 8 GB eMMC storage onboard
- 10/100/1000 Mbps Ethernet ports
- CANBus with programmable bit rate of up to 1 Mb/sec
- Embedded security chip for data security
- DIO wet contact & dry contact by switch support
- Isolated protection of digital input/output
- Optional mPCIe expansion slot for wireless modules
- Operating system Linux Ubuntu 16.04 (Default) and Yocto 2.1 support
- Wide operating temperature range (-20~55°C/-4~131°F)
- Advantech WISE-PaaS/Edgeline support with more than 200 I/O drivers

Introduction

The WISE-710 industrial IoT gateway is an open platform with Cortex A9 processor, equipped with 3 x serial ports, 2 x 10/100/1000 Ethernet ports, and 4 x DI/DO which is great solution to connect your legacy equipments to the new mesh networks. All collected data to the cloud is secured by key encryption technology from embedded security chip. With its rich I/O, and wide operating temperature design, the gateway plays a role as PLC-side protocol converter, and also data logger for multiple industrial applications.

Specifications

General

- **Certification** CE, FCC
- **Mounting** Wall-Mount/ DIN-Rail
- **Power Consumption** 5W @ 24V_{DC}
- **Power Requirements** 24V_{DC} ± 20%, 0.5A
- **Dimension (W x H x D)** 115.58 x 73 x 36 mm (tbc x 2.87 x 1.42 in)
- **OS Support** Linux Ubuntu 16.04 (Default) and Linux Yocto 2.1
- **Weight (Net)** 0.17 kg (0.375 lb)

System

- **CPU** NXP® ARM® Cortex™-A9 i.MX6 dual-core 1.0 GHz processor
- **Indicators** LEDs for Power, Wireless, LAN, Serial
- **Storage** 8GB eMMC
- **Working Memory** 1GB DDR3 RAM
- **SD Slot** 1 x Micro-SD slot
- **Real-time Clock** Yes

Communication

- **Serial Port** COM1 1x RS232/485, DB9, 0.15~115.2kbps
COM2 1x RS485/CANBus (by switch), 5pin, 50~921.6kbps; CANBus, 20~1000k
COM3 1x RS485, 2pin, 0.15~115.2kbps
- **Ethernet Port** 2 x 10/100/1000 Base-T RJ-45 ports
- **USB Port** 1 x Micro USB Host (Support flash storage)
- **Isolated DI/DO** 4-ch digital input, 4-ch digital output, isolation protection voltage 2000 V_{DC}
- **Expansion slot** 1x Full size mPCIe with USB signal

Gateway Software

- **Application Software** WISE-PaaS/Edgeline
- **Number of IO Tag** 3000 Tags
- **Protocol Support** more than 200 drivers

Environment

- **Operating Temperature** -20 ~ 55 °C (-4 ~ 131 °F) with 0.7 m/s air flow
- **Storage Temperature** -40 ~ 75 °C (-40 ~ 167 °F)
- **Humidity** 10 ~ 95% RH @ 40 °C, non-condensing
- **Vibration During Operation** 2 Grms, IEC 60068-2-64, random, 5 ~ 500 Hz, 1 hr/axis.
- **Shock During Operation** 10G, IEC 60068-2-27, half sine, 11 ms duration

Ordering Information

- **WISE-710-N600A** Cortex™-A9 Processor, Linux Ubuntu 16.04, 2 x LAN, 3 x COM, 4 x Di/DO, 1 x mPCIe
- **ESRP-PCS-WISE710** WISE-710-N600A with Linux Yocto, EdgeLink 3000 Tags

Expansion Kits

- **WISE-710-0010A** WISE-710 4AI/4DI Expansion kit
- **WISE-710-0020A** WISE-710 6DI/2DO/RS485(Modbus RTU) Expansion kit

Optional Accessories

WiFi Solution

- **968AD00259** Support WISE-710 and EdgeLink WiFi Module, RTL8188EE-VAU, 802.11 ac/a/b/g/n (2.4&5GHz), 1T1R
- **EWM-W170H01E** Support EdgeLink WiFi Module, QCA 9377-7, 802.11 ac/a/b/g/n (2.4&5GHz), 1T1R
- **968AD00605** Support WISE-710 and EdgeLink WiFi & BT Module RS9116, 802.11 a/b/g/n (2.4&5GHz), BT5, 1T1R
- **9656EWMG00E** Half-size to Full-size Mini PCIe Bracket Pack
- **1750009066-01** Dipole Ant. 2.4G WIFI 2.05dBi SMA/M-R RG178 BLK
- **1750009035-01** Cable Ant. SMA/F-BH MHF1/113 BLK L100mm

Dimensions

Unit: mm

WISE-710-N600A

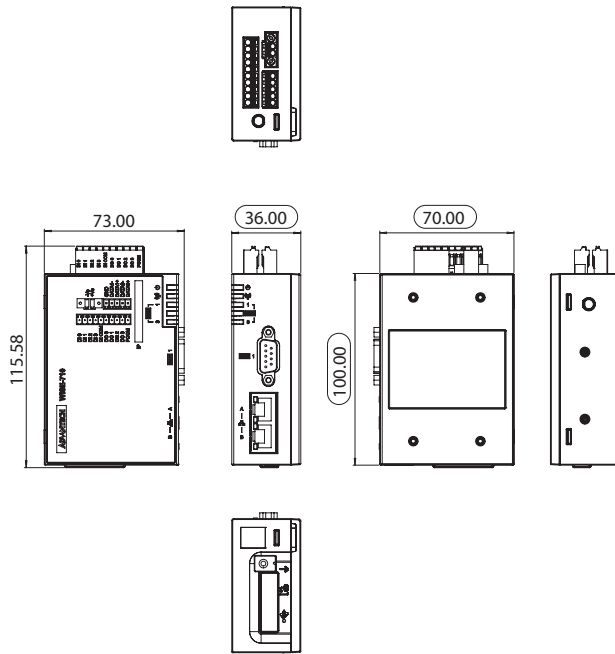

WISE-710-N600A + WISE-710-0010A

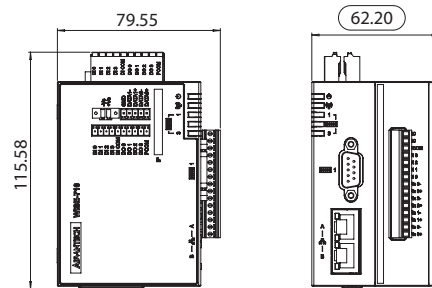

WISE-710-N600A + WISE-710-0020A

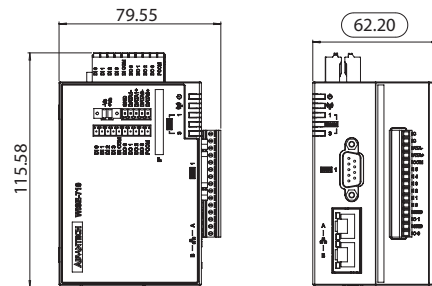

LTE Solution

- **EWM-C117FL03E** Support WISE-710 and EdgeLink, LTE Module with SIM Slot, TOBY-L200 for USA AT&T, T-Mobile
- **EWM-C117FL04E** Support WISE-710 and EdgeLink, LTE Module, SIM Slot, TOBY-L210 for Europe APAC
- **968AD00589** Support WISE-710 & EdgeLink, LTE Module, Global Band
- **1750009067-01** Dipole Ant. LTE 1.5/2dBi SMA/M BLK 144 (TELEC Certified)
- **1750009036-01** Cable Ant. SMA/F-R-BH MHF1/113 BLK L100mm (TELEC Certified)

Others

- **96FMMSDI-4G-ET-AT1** ATP 4G MICRO SD CARD I-GRD SLC(G)
- **96FMMSDI-8G-ET-AT1** ATP 8G MICRO SD CARD I-GRD SLC(G)

Power Supply

- **96PSD-A20W24-MM** A/D 100-240V 20W 24V MDR DIN RAIL
- **1700029720-01** M cable AC CONN 3P 183cm

Power Adaptor

- **XWISE-IPU15-108** 110-220V AC Adaptor, US AC Plug
- **XWISE-AUPLUG** AU Type Plug for XWISE-IPU15-108
- **XWISE-EUPLUG** EU Type Plug for XWISE-IPU15-108
- **XWISE-UKPLUG** UK Type Plug for XWISE-IPU15-108

Front I/O View

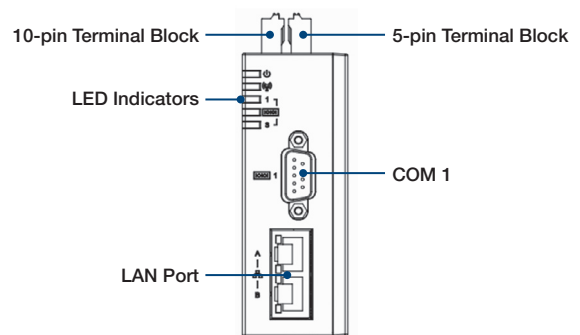

Top I/O View

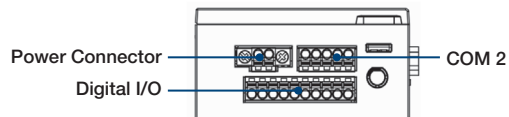

Underside I/O View

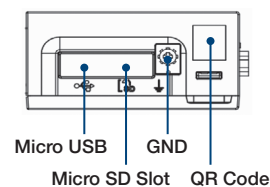

X-ON Electronics

Largest Supplier of Electrical and Electronic Components

Click to view similar products for [Gateways category](#):

Click to view products by [Advantech manufacturer](#):

Other Similar products are found below :

[BB-SG30000324-51](#) [MTCDT-LEU1-247A-915-EU-GB-AU](#) [MTCDTIP-LEU1-275L-868](#) [MTCDT-LEU1-246A-868-EU-GB](#) [100-1156-001IA](#)
[1120730001](#) [MTCDP-E1-DK](#) [MTCDP-GP-DK-1.0](#) [MTCAP-915-001A](#) [CSENSE-A710](#) [SGX5150000US](#) [EM3003-3815-2-8-WL-U-2YPS](#)
[EM3001-3805-2-8-WL-U-2YPS](#) [SGX5150202US](#) [SGX5150102US](#) [E5810B/1PS/900/PLG](#) [XPC250300S-02](#) [RG186](#) [RG191](#) [UP-GWS01-](#)
[A20-1432-A11](#) [UPS-EDGE-X70864-U01](#) [UPS-EDIOT-X70864-UW01](#) [ADAM-4572-CE](#) [ADAM-6717-A](#) [ECU-1152-R11ABE](#) [EKI-1222-CE](#)
[EKI-1224-CE](#) [EKI-1224CI-CE](#) [ESRP-PCS-WISE710](#) [ICR-3241](#) [ICR-3241W](#) [UNO-220-P4N1AE](#) [WISE-3310-D100L1E](#) [WISE-6610-E100-](#)
[A](#) [WISE-6610-N100-A](#) [WISE-710](#) [AKX00016](#) [MESR901](#) [MESR902T](#) [BB-SG30300525-42](#) [BB-SG30500520-42](#) [CSENSE-A300-N](#)
[CSENSE-A700](#) [X2E-Z3C-E1-A](#) [X2E-Z3C-E1-W](#) [X2E-Z3C-H2-W](#) [X2E-Z3C-W1-A](#) [X4-Z11-E-A](#) [X4-Z11-E-W](#) [X4-Z1U-B105](#)