

1N4099UR-1 thru 1N4135UR-1 & 1N4614UR-1 thru 1N4627UR-1



Low Noise Zener Diode Series

Rev. V3

Features

- Available in JAN, JANTX, JANTXV and JANS per MIL-PRF-19500/435
- Tight tolerances available in plus or minus 2% or 1% with C or D suffix respectively.
- 500 mW power handling
- Hermetically sealed MELF DO-213 package
- Also available in axial-leaded glass DO-35 style package.

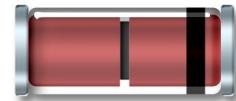
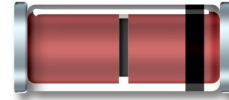

Electrical Specifications: $T_A = +25^\circ\text{C}$ (unless otherwise specified)

JEDEC TYPE No. (Note1)	Normal Zener Voltage VZ @ IZT	Zener Test Current IZT	Maximum Zener Impedance ZZT	Maximum Reverse Current IR @ VR		Maximum Noise Density ND @ IZT	Maximum Zener Current IZM
	Volts	A	Ohms	A	Volts	V / $\sqrt{\text{Hz}}$	mA
1N4099UR-1	6.8	250	200	10	5.17	40	56
1N4100UR-1	7.5	250	200	10	5.7	40	51
1N4101UR-1	8.2	250	200	1	6.24	40	46
1N4102UR-1	8.7	250	200	1	6.61	40	44
1N4103UR-1	9.1	250	200	1	6.92	40	42
1N4104UR-1	10	250	200	1	7.6	40	38
1N4105UR-1	11	250	200	0.05	8.44	40	35
1N4106UR-1	12	250	200	0.05	8.12	40	32
1N4107UR-1	13	250	200	0.05	9.857	40	29
1N4108UR-1	14	250	200	0.05	10.65	40	27
1N4109UR-1	15	250	100	0.05	11.4	40	25
1N4110UR-1	16	250	100	0.05	12.15	40	24
1N4111UR-1	17	250	100	0.05	12.92	40	22
1N4112UR-1	18	250	100	0.05	13.67	40	21
1N4113UR-1	19	250	150	0.05	14.44	40	20
1N4114UR-1	20	250	150	0.01	15.2	40	19
1N4115UR-1	22	250	150	0.01	16.72	40	17
1N4116UR-1	24	250	150	0.01	18.25	40	16
1N4117UR-1	25	250	150	0.01	19	40	15
1N4118UR-1	27	250	150	0.01	20.45	40	14
1N4119UR-1	29	250	200	0.01	21.28	40	14
1N4120UR-1	30	250	200	0.01	22.8	40	13

(Continued next page)

1N4099UR-1 thru 1N4135UR-1 & 1N4614UR-1 thru 1N4627UR-1



Low Noise Zener Diode Series

Rev. V3

Electrical Specifications: $T_A = +25^\circ\text{C}$ (unless otherwise specified)

JEDEC TYPE No. (Note1)	Normal Zener Voltage VZ @ IZT	Zener Test Current IZT	Maximum Zener Impedance ZZT	Maximum Reverse Current IR @ VR		Maximum Noise Density ND @ IZT	Maximum Zener Current IZM
	Volts	A	Ohms	A	Volts	V / $\sqrt{\text{Hz}}$	mA
1N4121UR-1	33	250	200	0.01	25.08	40	12
1N4122UR-1	36	250	200	0.01	27.38	40	11
1N4123UR-1	39	250	200	0.01	29.65	40	9.8
1N4124UR-1	43	250	250	0.01	32.65	40	8.9
1N4125UR-1	47	250	250	0.01	35.75	40	8.1
1N4126UR-1	51	250	300	0.01	38.76	40	7.5
1N4127UR-1	56	250	300	0.01	42.6	40	6.7
1N4128UR-1	60	250	400	0.01	45.6	40	6.4
1N4129UR-1	62	250	500	0.01	47.1	40	6.1
1N4130UR-1	68	250	700	0.01	51.68	40	5.6
1N4131UR-1	75	250	700	0.01	57	40	5.1
1N4132UR-1	82	250	800	0.01	62.32	40	4.6
1N4133UR-1	87	250	1000	0.01	66.12	40	4.4
1N4134UR-1	91	250	1200	0.01	69.16	40	4.2
1N4135UR-1	100	250	1500	0.01	76	40	3
1N4614UR-1	1.8	250	1200	7.5	1	1	120
1N4615UR-1	2	250	1250	5	1	1	110
1N4616UR-1	2.2	250	1300	4	1	1	100
1N4617UR-1	2.4	250	1400	2	1	1	95
1N4618UR-1	2.7	250	1500	1	1	1	90
1N4619UR-1	3	250	1600	0.8	1	1	87
1N4620UR-1	3.3	250	1650	7.5	1.5	1	85
1N4621UR-1	3.6	250	1700	7.5	2	1	83
1N4622UR-1	3.9	250	1650	5	2	1	80
1N4623UR-1	4.3	250	1600	4	2	1	77
1N4624UR-1	4.7	250	1550	10	2	1	75
1N4625UR-1	5.1	250	1500	10	3	2	70
1N4626UR-1	5.6	250	1400	10	4	4	65
1N4627UR-1	6.2	250	1200	10	5	5	61

1. The JEDEC type numbers shown with no suffix have a standard tolerance of +5% on the nominal Zener voltage; suffix C is used to identify +2%; and suffix D is used identify +1% tolerance. Vz is measured with the diode in thermal equilibrium in 25°C still air.

Absolute Maximum Ratings

Parameter	Absolute Maximum
Steady State Power Dissipation	0.5 W
Forward Voltage	1.1 V @ 200 mA
Thermal Resistance	250°C/W
Operating & Storage Temperature	-65°C to +175°C

1N4099UR-1 thru 1N4135UR-1 & 1N4614UR-1 thru 1N4627UR-1

Low Noise Zener Diode Series

Rev. V3

Outline Drawing

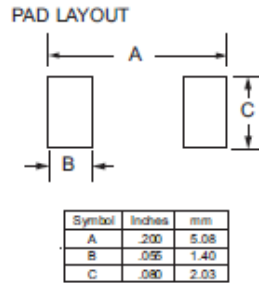
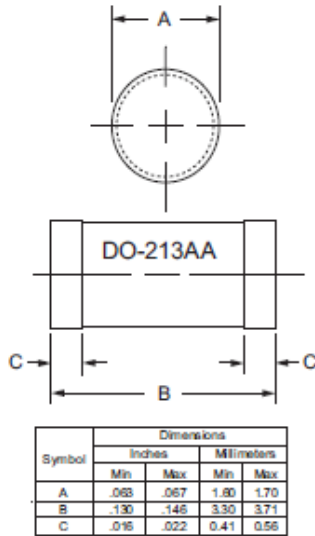

LEADED DESIGN DATA

CASE: DO-213AA, Hermetically sealed glass case. (MELF, SOD-80, LL34)

LEAD FINISH: Tin / Lead

THERMAL RESISTANCE: ($R_{\theta JEC}$): 100 °C/W maximum at L = 0 inch

THERMAL IMPEDANCE: ($Z_{\theta JX}$): 25 °C/W maximum

POLARITY: Diode to be operated with the banded (cathode) end positive.

MOUNTING POSITION: Any.

Circuits & graphs

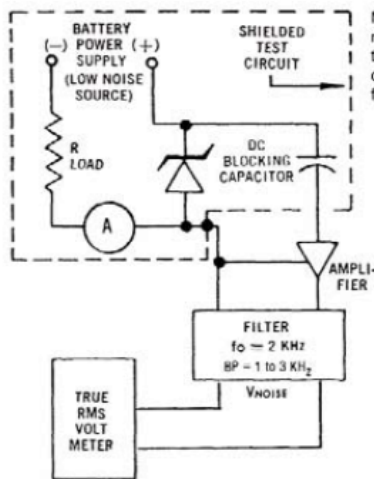

FIGURE 1
NOISE DENSITY MEASUREMENT CIRCUIT

Noise density, (N_D) is specified in microvolt-rms per square-root-hertz. Actual measurement is performed using a 1 KHz to 3 KHz frequency bandpass filter at a constant Zener test current (I_T) AT 25°C ambient temperature. N_D is calculated from the formula.

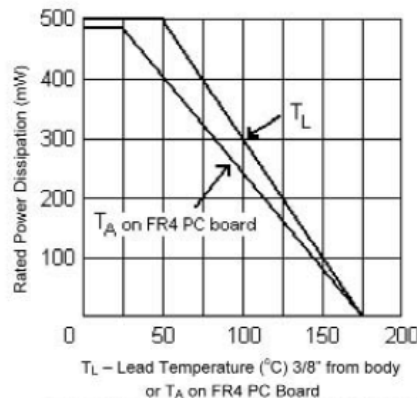

FIGURE 2 – POWER DERATING CURVE

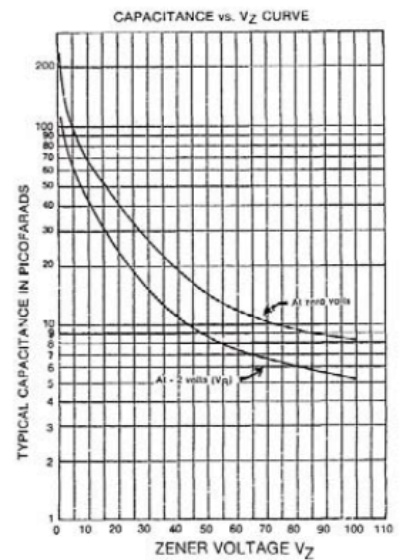

FIGURE 3
CAPACITANCE vs. ZENER VOLTAGE (TYPICAL)

1N4099UR-1 thru 1N4135UR-1 & 1N4614UR-1 thru 1N4627UR-1



Low Noise Zener Diode Series

Rev. V3

VPT Components, All rights reserved.

Information in this document is provided in connection with VPT Components products. These materials are provided by VPT Components as a service to its customers and may be used for informational purposes only. Except as provided in VPT Components Terms and Conditions of Sale for such products or in any separate agreement related to this document, VPT Components assumes no liability whatsoever. VPT Components assumes no responsibility for errors or omissions in these materials. VPT Components may make changes to specifications and product descriptions at any time, without notice. VPT Components makes no commitment to update the information and shall have no responsibility whatsoever for conflicts or incompatibilities arising from future changes to its specifications and product descriptions. No license, express or implied, by estoppels or otherwise, to any intellectual property rights is granted by this document.

THESE MATERIALS ARE PROVIDED "AS IS" WITHOUT WARRANTY OF ANY KIND, EITHER EXPRESS OR IMPLIED, RELATING TO SALE AND/OR USE OF VPT COMPONENTS PRODUCTS INCLUDING LIABILITY OR WARRANTIES RELATING TO FITNESS FOR A PARTICULAR PURPOSE, CONSEQUENTIAL OR INCIDENTAL DAMAGES, MERCHANTABILITY, OR INFRINGEMENT OF ANY PATENT, COPYRIGHT OR OTHER INTELLECTUAL PROPERTY RIGHT. VPT COMPONENTS FURTHER DOES NOT WARRANT THE ACCURACY OR COMPLETENESS OF THE INFORMATION, TEXT, GRAPHICS OR OTHER ITEMS CONTAINED WITHIN THESE MATERIALS. VPT COMPONENTS SHALL NOT BE LIABLE FOR ANY SPECIAL, INDIRECT, INCIDENTAL, OR CONSEQUENTIAL DAMAGES, INCLUDING WITHOUT LIMITATION, LOST REVENUES OR LOST PROFITS, WHICH MAY RESULT FROM THE USE OF THESE MATERIALS.

VPT Components products are not intended for use in medical, lifesaving or life sustaining applications. VPT Components customers using or selling VPT Components products for use in such applications do so at their own risk and agree to fully indemnify VPT Components for any damages resulting from such improper use or sale.

X-ON Electronics

Largest Supplier of Electrical and Electronic Components

Click to view similar products for [Zener Diodes](#) category:

Click to view products by [Aeroflex](#) manufacturer:

Other Similar products are found below :

[MMSZ5245BS-7-F](#) [RKZ13B2KG#P1](#) [RKZ5.6B2KJ#R1](#) [EDZTE6113B](#) [EDZTE6116B](#) [EDZTE616.8B](#) [1N747A](#) [1N966B](#) [NTE5116A](#)
[NTE5121A](#) [NTE5139A](#) [NTE5147A](#) [NTE5152A](#) [NTE5156A](#) [NTE5164A](#) [JANS1N4974US](#) [SMAJ4764A-TP](#) [RKZ5.1BKU#P6](#)
[3SMAJ5946B-TP](#) [3SMAJ5950B-TP](#) [3SMBJ5920B-TP](#) [3SMBJ5925B-TP](#) [TDZTR24](#) [441774C](#) [MMSZ4678-TP](#) [MMSZ5232BQ-13-F](#)
[BZG04-36](#) [BZG05C9V1-HE3-TR](#) [HZM30NBTR-E](#) [UDZTE-175.1B](#) [3SMAJ5945B-TP](#) [3SMAJ5947B-TP](#) [3SMBJ5941B-TP](#) [DL4746A-TP](#)
[RKZ18B2KK#R1](#) [RKZ10B2KL#R1](#) [RKZ6.8B2KL#R1](#) [RKZ8.2B2KL#R1](#) [DZ2S240M0L](#) [SMAZ27-TP](#) [SMBZ5920B-E3/52](#) [ZMM3.0](#)
[RD16UM-T1-A](#) [RD39S-T1-A](#) [RD9.1S-T1-A](#) [RD10S-T1-A](#) [RD20S-T1-A](#) [RD2.2S-T1-A](#) [RD2.7UM-T1-A](#) [HZM24NB1TL-E](#)