

# ATM2604KNSG

## 20V N-Channel Enhancement Mode MOSFET

### Descriptions

The ATM2604KNSG uses advanced trench technology to provide excellent  $R_{DS(ON)}$ , low gate charge and operation with gate voltages as low as 2.5V. This device is suitable for use as a load switch or in PWM applications.

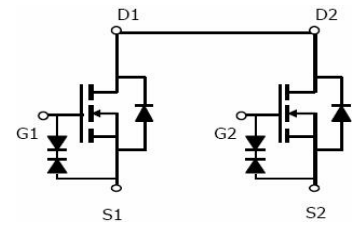

Schematic diagram

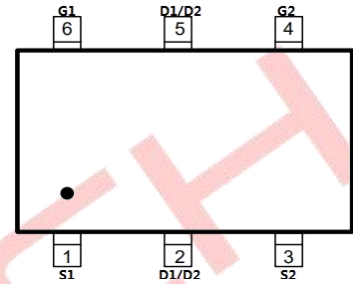

pin Assignment

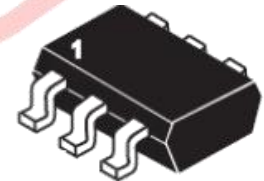

SOT23-6L top view

### Features

- $R_{DS(ON)} < 21m\ \Omega$  @  $V_{GS}=2.5V$
- $R_{DS(ON)} < 15m\ \Omega$  @  $V_{GS}=4.5V$
- High power and current handling capability
- Lead free product is acquired
- Surface mount package

### Applications

- PWM application
- Load switch

### Absolute Maximum Ratings (Ta=25°C unless otherwise specified)

Parameter	Symbol	Maximum	Units	
Drain-Source Voltage	$V_{DS}$	20	V	
Gate-Source Voltage	$V_{GS}$	$\pm 8$	V	
Drain Current-Continuous	$I_D$	5	A	
Drain Current-Pulsed(Note 1)	$I_{DM}$	30	A	
Power Dissipation	$P_D$	1.2	W	
Operating Junction and Storage Temperature Range	$T_J, T_{STG}$	150, -55 ~ +150	°C	
Parameter	Symbol	Typ	Max	Unit
Maximum Junction-to-Ambient(Note 2)	$R_{\theta JA}$	64	83	°C/W

# ATM2604KNSG

## Electrical Characteristics (Ta=25°C unless otherwise specified)

Parameter	Symbo	Test Conditions	Min	Typ	Max	Unit
<b>Static Parameters</b>						
Drain-Source breakdown voltage	BVDSS	ID=250uA, VGS=0V	20	-	-	V
Zero Gate voltage drain current	IDSS	VDS=16V, VGS=0V	-	-	1	uA
Gate-Body leakage current	IGSS	VDS=0V, VGS=±8V	-	-	±10	uA
Gate Threshold voltage(Note 3)	VGS(th)	VGS=VDS, ID=250uA	0.4	0.7	1	V
On state drain current	ID(ON)	VGS=4.5V, VDS=5V	30	-	-	A
Static Drain-source on-resistance(Note 3)	RDS(on)	VGS=4.5V, ID=5A		12	25	mΩ
		VGS=2.5V, ID=3A		15	35	mΩ
Forward Transconductance(Note 3)	gFS	VDS=5V, ID=5A	-	31	-	S
Diode Forward Voltage(Note 3)	VSD	Is=1A, VGS=0V	-	0.7	1.3	V
Maximum Body-Diode Continuous Current(Note 2)	Is		-	-	2.5	A
<b>Dynamic Parameters</b>						
Input Capacitance(Note 4)	Ciss	VGS=0V, VDS=10V, f=1MHZ	-	1120	-	pF
Output capacitance(Note 4)	Coss		-	195	-	pF
Reverse transfer capacitance(Note 4)	Crss		-	155	-	pF
Gate resistance	Rg	VGS=0V, VDS=0V, f=1MHZ	-	4.0	-	Ω
<b>Switching Parameters</b>						
Total Gate charge(Note 4)	Qg	VGS=4.5V, VDS=10V, ID=5A	-	16	-	nC
Gate Source charge(Note 4)	Qgs		-	1.7	-	nC
Gate Drain charge(Note 4)	Qgd		-	6.8	-	nC
Turn-on delaytime(Note 4)	tD(on)	VGS=5V, VDD=10V, RL=1.35 Ω, RGEN=3 Ω	-	7.2	-	ns
Turn-on rise time(Note 4)	tr		-	11	-	ns
Turn-off delaytime(Note 4)	tD(off)		-	64	-	ns
Turn-off fall time(Note 4)	tf		-	32	-	ns
Body Diode reverse recovery Time	trr	IF=5A, dI/dt=100A/us	-	32	-	ns
Body diode reverse recovery charge	Qrr	IF=5A, dI/dt=100A/us	-	12	-	nC

### Notes:

1. Repetitive Rating: Pulse width limited by maximum junction temperature.
2. Surface Mounted on FR4 Board, t ≤ 10 sec.
3. Pulse Test: Pulse Width ≤ 300μs, Duty Cycle ≤ 2%.
4. Guaranteed by design, not subject to production

# ATM2604KNSG

## Typical Characteristics Curves

**Power Dissipation**

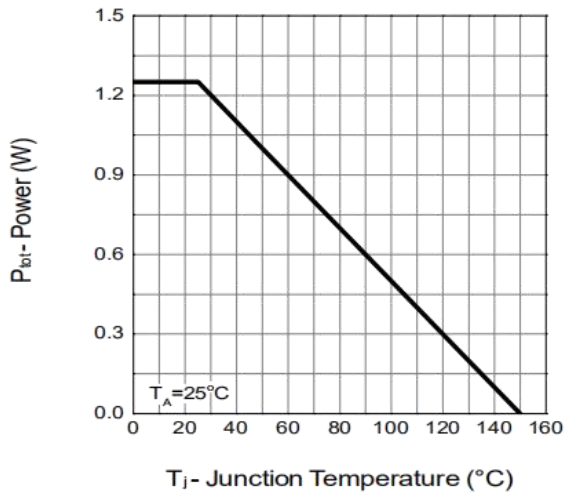

**Drain Current**

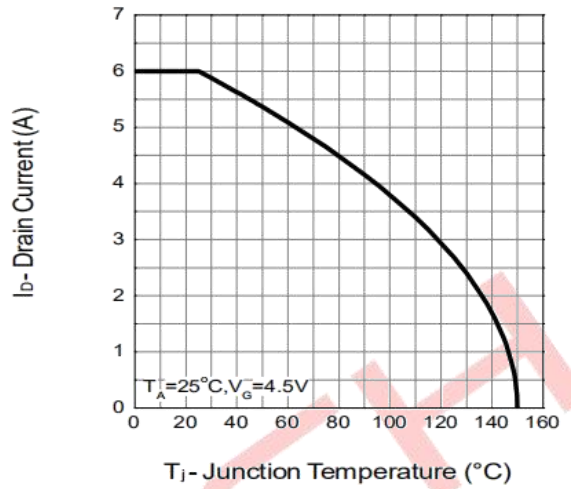

**Safe Operation Area**

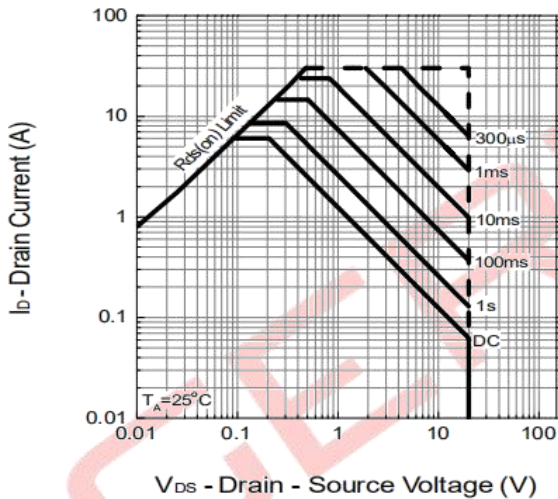

**Thermal Transient Impedance**

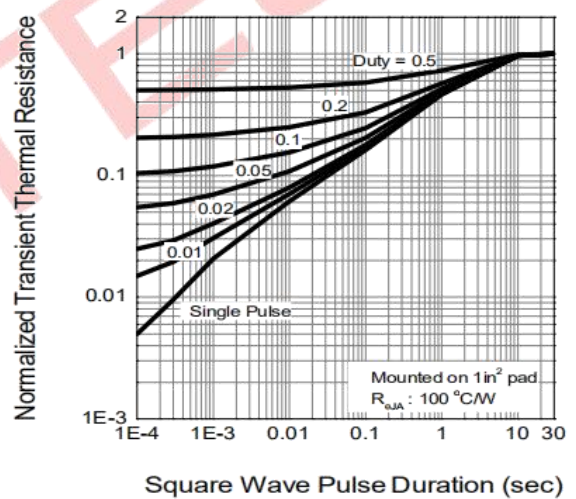

**Output Characteristics**

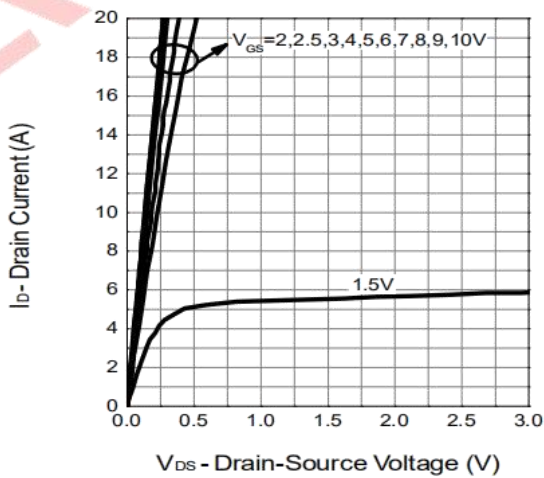

**Drain-Source On Resistance**

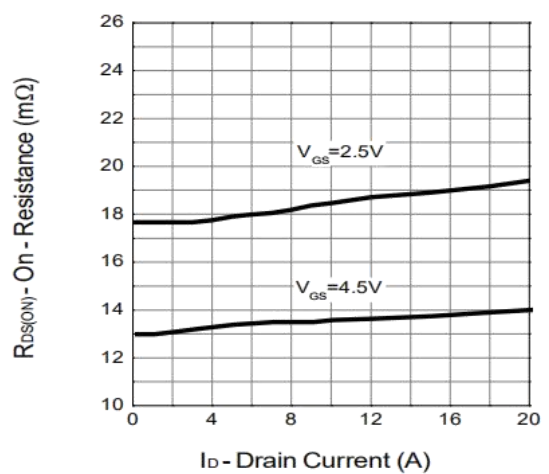

**Gate-Source On Resistance**

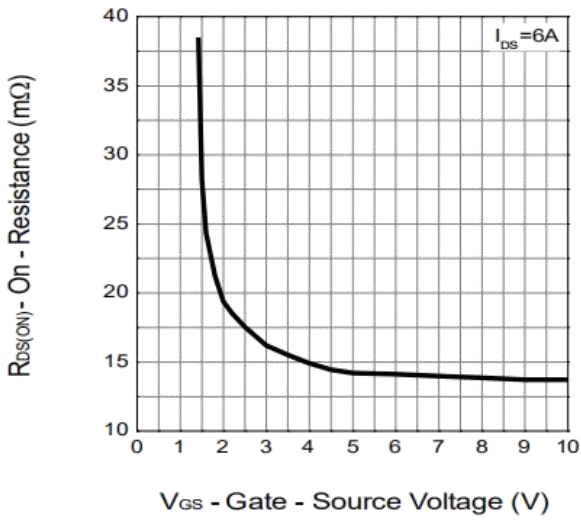

**Gate Threshold Voltage**

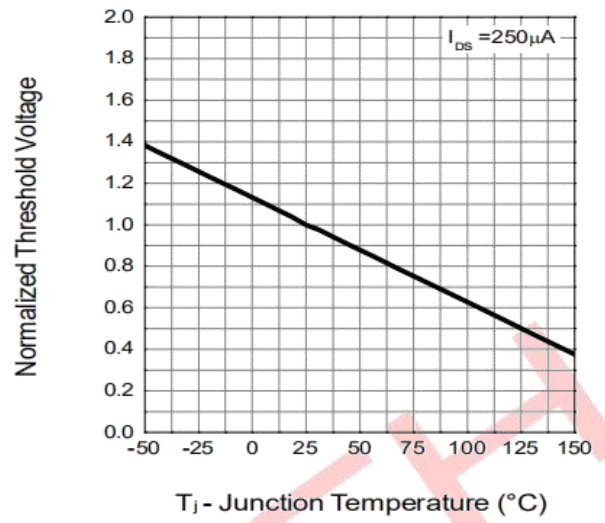

**Drain-Source On Resistance**

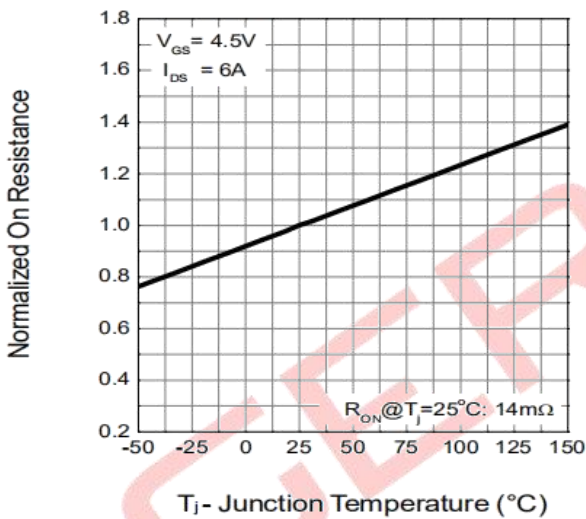

**Source-Drain Diode Forward**

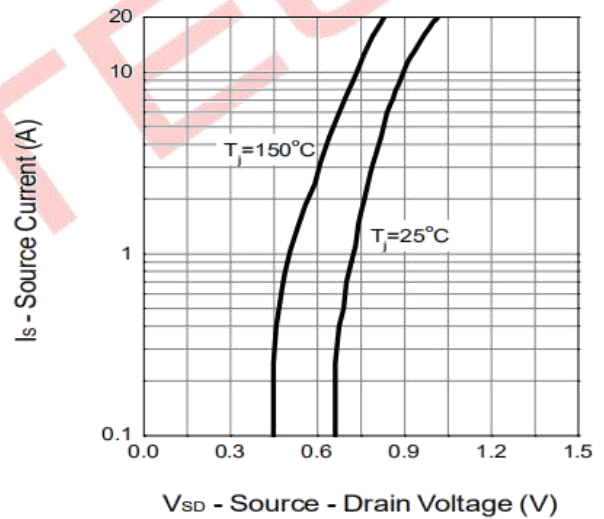

**Capacitance**

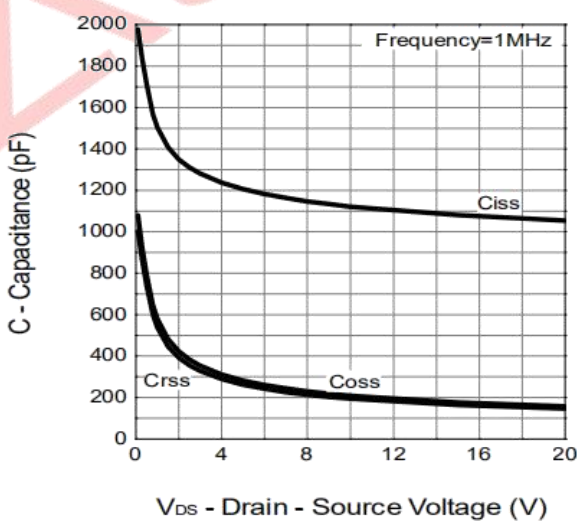

**Gate Charge**

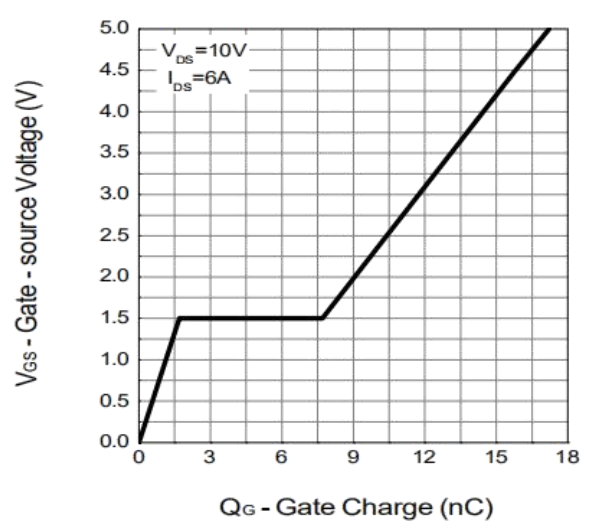

# ATM2604KNSG

## Package outline

SOT23-6

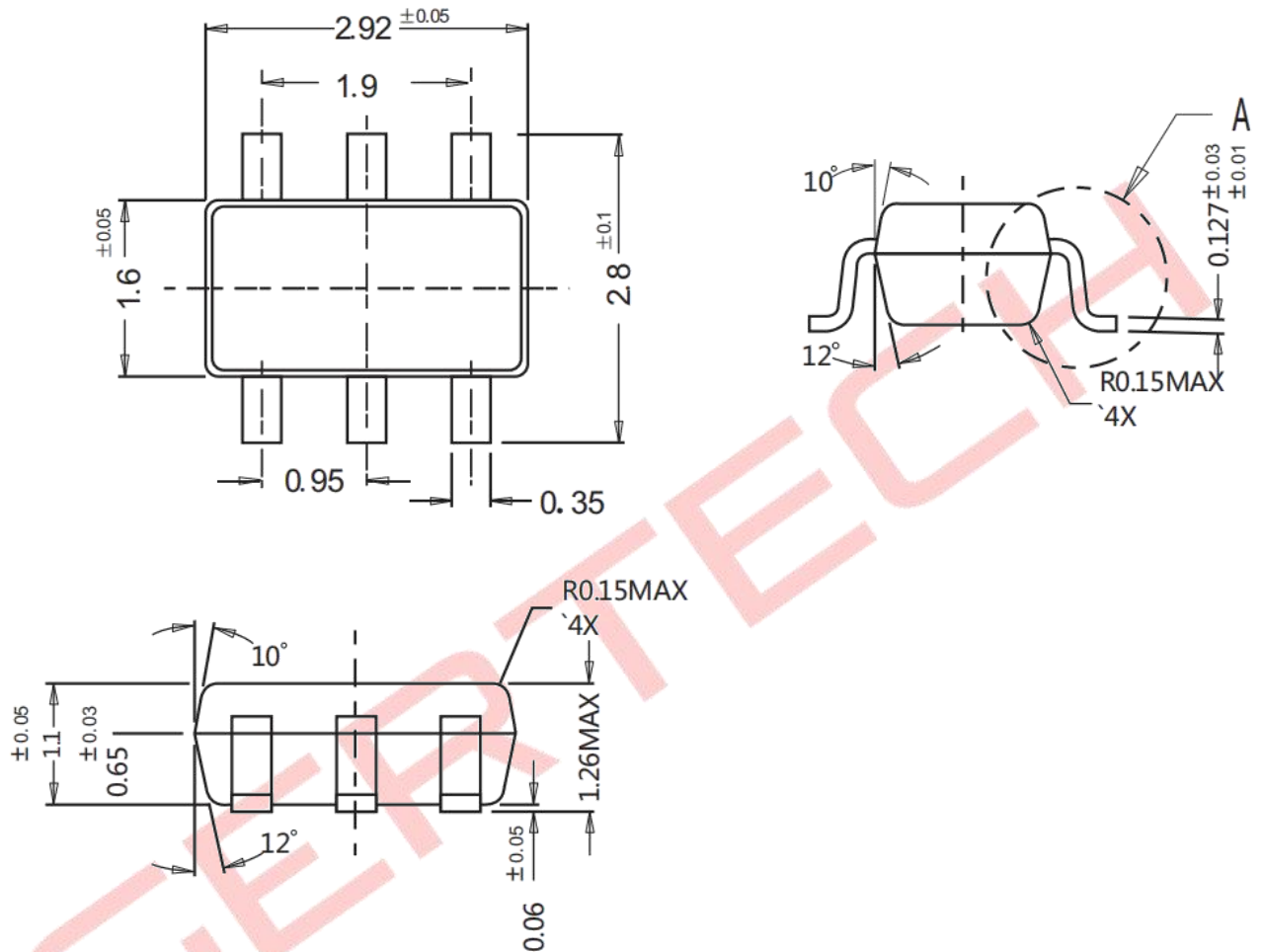

### Ordering information

Device	Package	Marking	Shipping
ATM2604KNSG	SOT23-6	2604	3000PCS/Reel&Tape(7inch)

## X-ON Electronics

Largest Supplier of Electrical and Electronic Components

*Click to view similar products for [MOSFET](#) category:*

*Click to view products by [Agertech](#) manufacturer:*

Other Similar products are found below :

[614233C](#) [648584F](#) [MCH3443-TL-E](#) [MCH6422-TL-E](#) [NTNS3A92PZT5G](#) [IRFD120](#) [IRFF430](#) [JANTX2N5237](#) [2N7000](#) [AOD464](#)  
[2SK2267\(Q\)](#) [2SK2545\(Q,T\)](#) [405094E](#) [423220D](#) [MIC4420CM-TR](#) [VN1206L](#) [614234A](#) [715780A](#) [SSM6J414TU,LF\(T](#) [751625C](#)  
[IPS70R2K0CEAKMA1](#) [BSF024N03LT3 G](#) [PSMN4R2-30MLD](#) [TK31J60W5,S1VQ\(O](#) [2SK2614\(TE16L1,Q\)](#) [DMN1017UCP3-7](#)  
[EFC2J004NUZTDG](#) [FCAB21350L1](#) [P85W28HP2F-7071](#) [DMN1053UCP4-7](#) [NTE2384](#) [NTE2969](#) [NTE6400A](#) [DMC2700UDMQ-7](#)  
[DMN2080UCB4-7](#) [DMN61D9UWQ-13](#) [US6M2GTR](#) [DMN31D5UDJ-7](#) [SSM6P54TU,LF](#) [DMP22D4UFO-7B](#) [IPS60R3K4CEAKMA1](#)  
[DMN1006UCA6-7](#) [DMN16M9UCA6-7](#) [STF5N65M6](#) [IRF40H233XTMA1](#) [IPSA70R950CEAKMA1](#) [IPSA70R2K0CEAKMA1](#) [STU5N65M6](#)  
[C3M0021120D](#) [DMN6022SSD-13](#)