

## Switching Diodes

### FEATURES

- ◆ For surface mount application
- ◆ Fast reverse recovery time
- ◆ Ideal for automated placements
- ◆ Lead free in comply with EU RoHS2011/65/EU directives

SOT-23

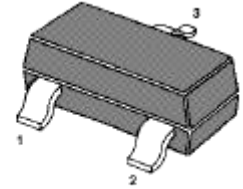

Marking:A7

### Absolute Maximum Ratings at 25 °C

Parameter	Symbol	Limits	Units
Maximum Repetitive Peak Reverse Voltage	VRRM	85	V
Reverse Voltage	V <sub>R</sub>	75	V
Forward Current(double diode load)	I <sub>F</sub>	200	mA
Non-repetitive Peak Forward surge current at t=1s at t=1ms at t=1us	I <sub>FSM</sub>	0.5 1 4.5	A
Power Dissipation	P <sub>D</sub>	350	mW
Operating and Storage Temperature Range	T <sub>j</sub> , T <sub>stg</sub>	150,-65 ~ +150	°C

### Characteristics at Ta = 25 °C

Parameter	Symbol	Limits	Units
Maximum Forward Voltage at I <sub>F</sub> =1mA at I <sub>F</sub> =10mA at I <sub>F</sub> =50mA at I <sub>F</sub> =150mA	V <sub>F</sub>	0.715 0.855 1 1.25	V
Peak Reverse Current at V <sub>R</sub> =25V at V <sub>R</sub> =75V at V <sub>R</sub> =25V,T <sub>j</sub> =150 °C at V <sub>R</sub> =75V,T <sub>j</sub> =150 °C	I <sub>R</sub>	30 1 30 50	uA
Typical Junction Capacitance f=1MHz,V <sub>R</sub> =4V	C <sub>j</sub>	1.5	pF
Maximum Reverse Recovery Time	t <sub>rr</sub>	4	ns

## RATINGS AND CHARACTERISTIC CURVES

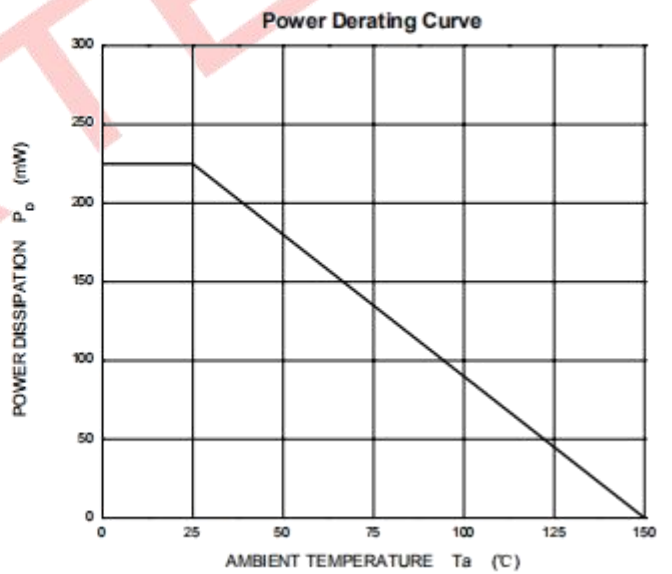
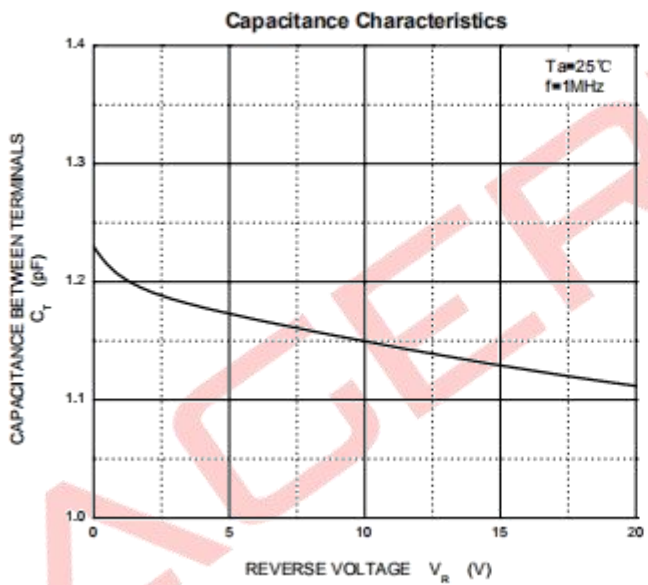
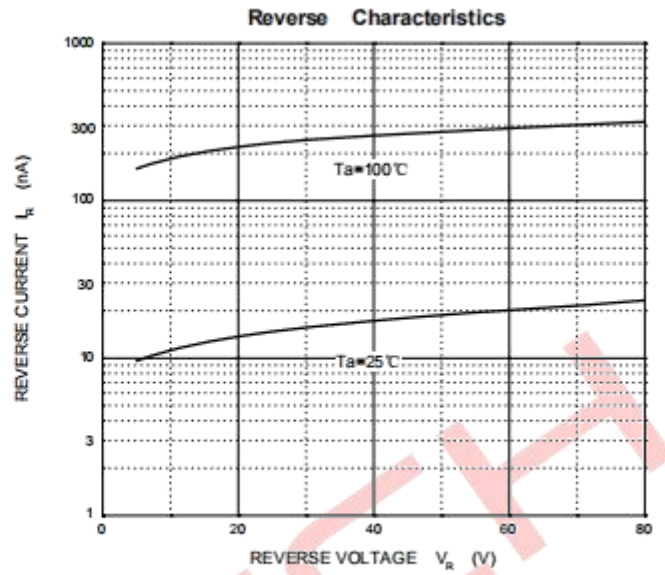
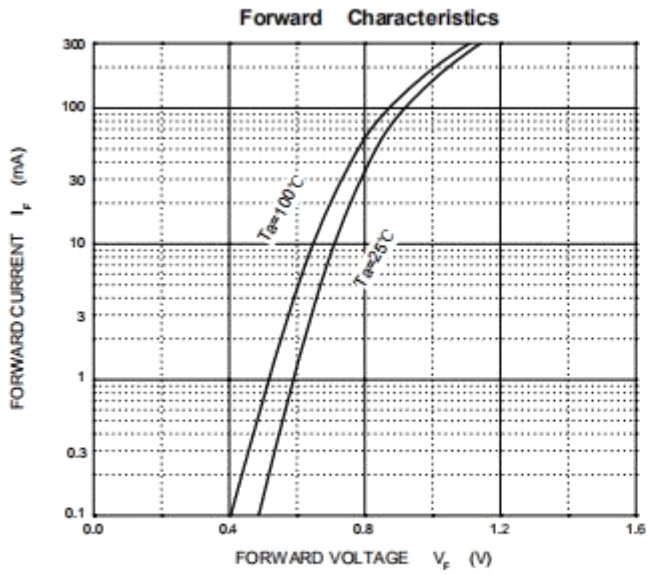

# BAV99

## PACKAGE OUTLINE

SOT-23

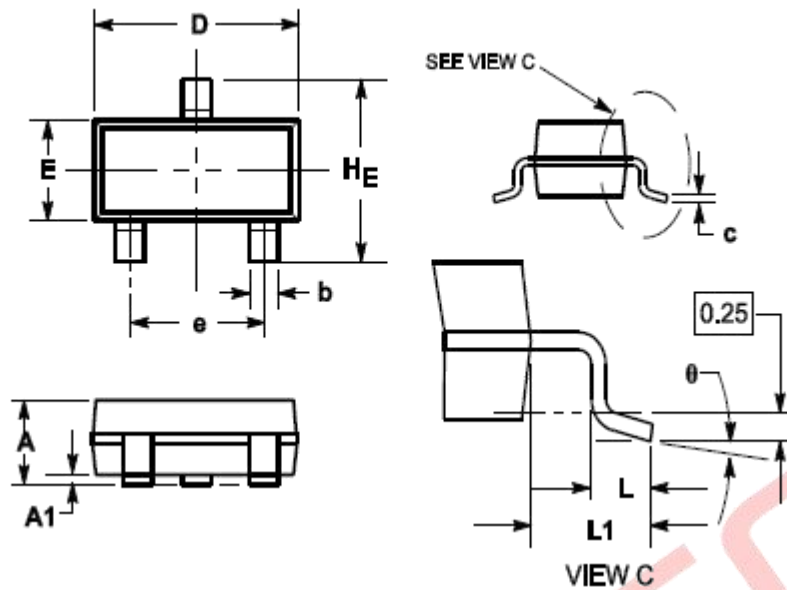

Symbol	Dimensions in millimeter		
	Min.	Typ.	Max.
A	0.900	1.025	1.150
A1	0.000	0.050	0.100
b	0.300	0.400	0.500
c	0.080	0.115	0.150
D	2.800	2.900	3.000
E	1.200	1.300	1.400
HE	2.250	2.400	2.550
e	1.800	1.900	2.000
L1	0.550REF		
L	0.300		0.500
θ	0°		8°

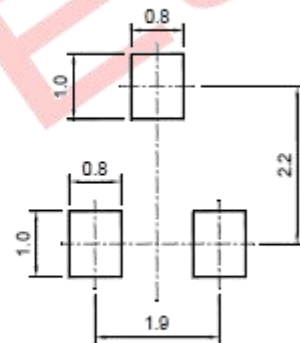

SOT-23 (TO-236)

Recommended soldering pad

### Ordering Information

Device	Package	Shipping
BAV99	SOT-23	3000/Reel&Tape(7 inch)

## X-ON Electronics

Largest Supplier of Electrical and Electronic Components

*Click to view similar products for* [Diodes - General Purpose, Power, Switching category:](#)

*Click to view products by* [Agertech manufacturer:](#)

Other Similar products are found below :

[MMBD3004S-13-F](#) [RD0306T-H](#) [BAV17-TR](#) [BAV19-TR](#) [HSC285TRF-E](#) [1N3611](#) [NTE156A](#) [NTE574](#) [NTE6244](#) [1SS181-TP](#) [1SS193,LF](#)  
[1SS400CST2RA](#) [SDAA13](#) [SHN2D02FUTW1T1G](#) [LS4151GS08](#) [1N4449](#) [1N456A](#) [1N4934-E3/73](#) [1N914B](#) [1N914BTR](#) [1SS226-TP](#)  
[RFUH20TB3S](#) [D291S45T](#) [BAV300-TR](#) [BAW56DWQ-7-F](#) [BAW75-TAP](#) [MM230L-CAA](#) [IDW40E65D1](#) [JAN1N3600](#) [LL4151-GS18](#)  
[053684A](#) [SMMSD4148T3G](#) [707803H](#) [NSVDAN222T1G](#) [CDSZC01100-HF](#) [LL4150-M-08](#) [1N4454-TR](#) [BAV199E6433HTMA1](#) [BAS28-7](#)  
[BAW56HDW-13](#) [BAS28 TR](#) [VS-HFA04SD60STR-M3](#) [NSVM1MA152WKT1G](#) [RGP30D-E3/73](#) [BAV99TQ-13-F](#) [BAS21DWA-7](#)  
[BAV99HDW-13](#) [NTE6250](#) [NTE582-4](#) [NTE582-6](#)