

SS22-AT thru SS220-AT

SURFACE MOUNT SCHOTTKY BARRIER RECTIFIER

Reverse Voltage:20 to 200 V Forward Current:2.0A

FEATURES

- ◆ Metal silicon junction, majority carrier conduction
- ◆ For surface mounted applications
- ◆ Low power loss, high efficiency
- ◆ High forward surge current capability
- ◆ For use in low voltage, high frequency inverters, free wheeling, and polarity protection applications

PINNING

PIN	DESCRIPTION
1	Cathode
2	Anode



MECHANICAL DATA

- ◆ Case: SMA mold plastic body
- ◆ Terminals: Solderable per MIL-STD-750, Method 2026
- ◆ Weight: Approximated 60 milligrams

Simplified outline SMA and symbol

MAXIMUM RATINGS AND ELECTRICAL CHARACTERISTICS

Ratings at 25 °C ambient temperature unless otherwise specified.

Single phase, half wave, 60Hz resistive or inductive load, for capacitive load, derated by 20 %.

PARAMETER	SYMBOL	SS22	SS24	SS26	SS28	SS210	SS212	SS215	SS220	UNIT
		-AT	-AT	-AT	-AT	-AT	-AT	-AT	-AT	
Maximum Repetitive Peak Reverse Voltage	V_{RRM}	20	40	60	80	100	120	150	200	V
Maximum RMS voltage	V_{RMS}	14	28	42	56	70	84	105	140	V
Maximum DC Blocking Voltage	V_{DC}	20	40	60	80	100	120	150	200	V
Maximum Average Forward Rectified Current	$I_{F(AV)}$	2.0								A
Peak Forward Surge Current ^{Note 1}	I_{FSM}	50								A
Max Instantaneous Forward Voltage at 2A	V_F	0.55	0.70		0.85		0.90		V	
Maximum DC Reverse Current $T_A = 25^{\circ}C$ at Rated DC Reverse Voltage $T_A = 100^{\circ}C$	I_R	0.5			0.3				mA	
		5			3					
Typical Junction Capacitance ^{Note 2}	C_J	220		80					pF	
Typical Thermal Resistance ^{Note 3}	$R_{\theta JA}$	80								$^{\circ}C/W$
Operating Junction Temperature Range	T_J	-55 ~ +125								$^{\circ}C$
Storage Temperature Range	T_{STG}	-55 ~ +150								$^{\circ}C$

Note: 1. 8.3ms Single half sine-wave superimposed on rated load (JEDEC method).

2. Measured at 1MHz and applied reverse voltage of 4 V D C.

3. P.C.B. mounted with 2.0" X 2.0" (5 X 5 cm) copper pad areas.

SS22-AT thru SS220-AT

RATING AND CHARACTERISTIC CURVES

Fig.1 Forward Current Derating Curve

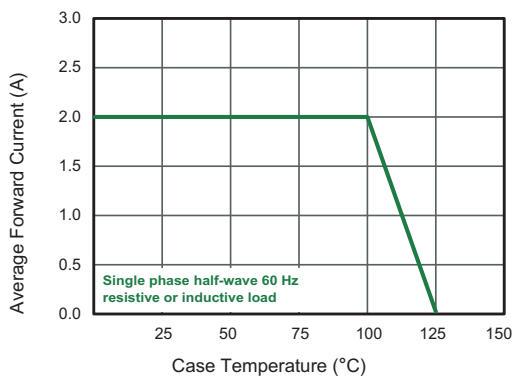

Fig.2 Typical Reverse Characteristics

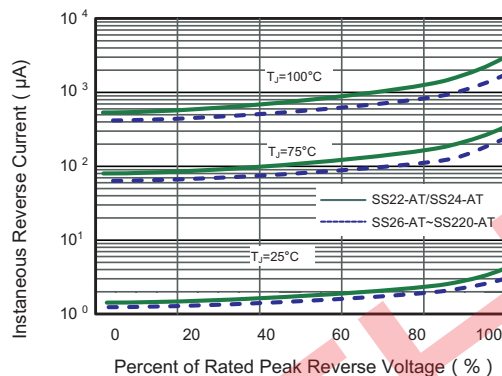

Fig.3 Typical Forward Characteristic

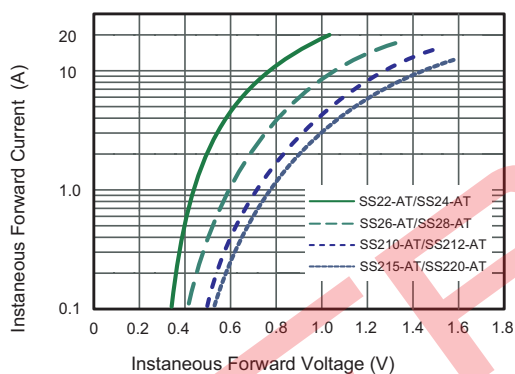

Fig.4 Typical Junction Capacitance

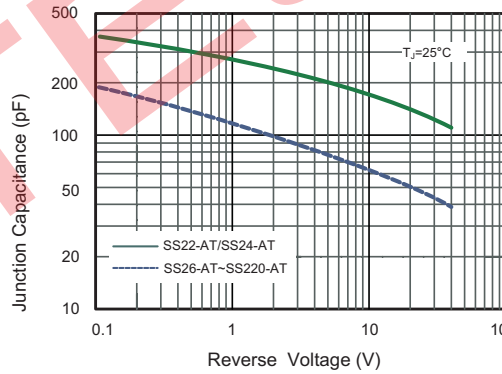

Fig.5 Maximum Non-Repetitive Peak Forward Surge Current

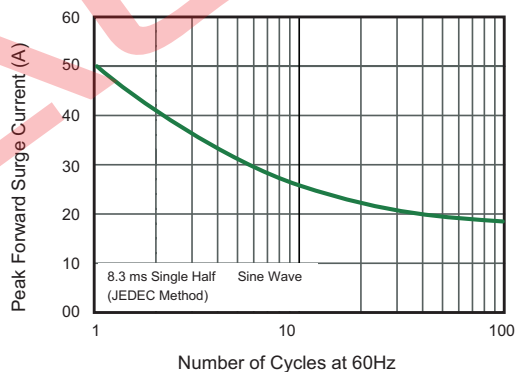
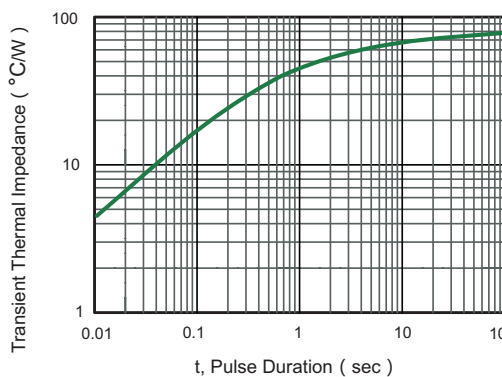

Fig.6 Typical Transient Thermal Impedance



SS22-AT thru SS220-AT

PACKAGE OUTLINE

SMA

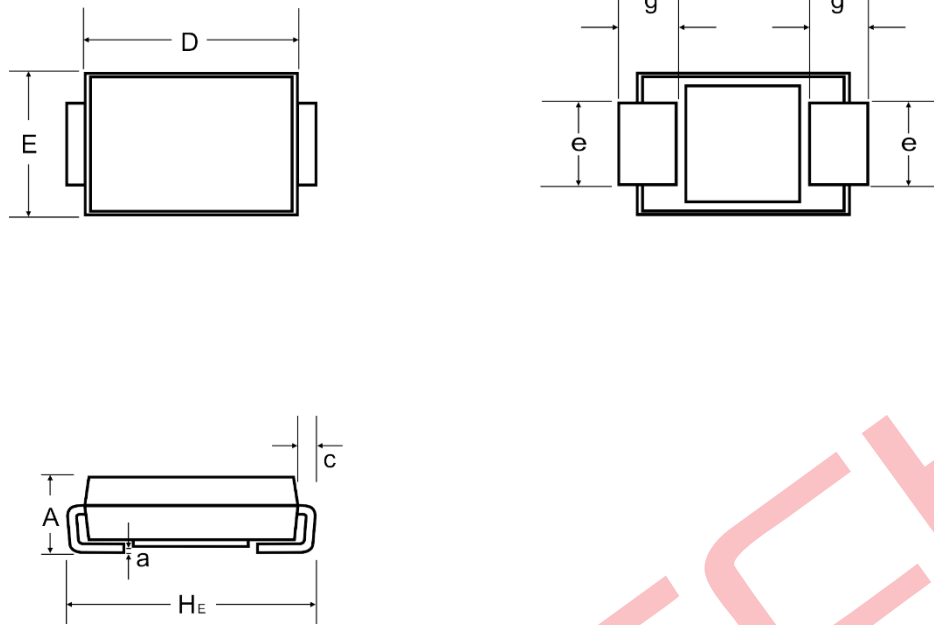

RECOMMEND MOUNTING PAD SIZE

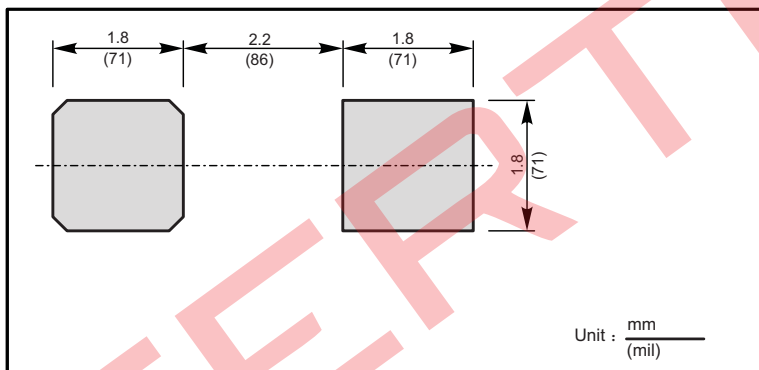

SMA Mechanical Data

UNIT		A	D	E	H _E	a	c	e	g
mm	max	2.2	4.5	2.7	5.2	0.3	0.31	1.6	1.5
	min	1.9	4.0	2.3	4.7		0.15	1.3	0.9
mil	max	87	181	106	205	12	12	63	59
	min	75	157	91	185		6	51	35

ORDERING INFORMATION

Device	Package	Shipping
SS22-AT thru SS220-AT	SMA	5,000/ Tape & Reel (13 inches)

X-ON Electronics

Largest Supplier of Electrical and Electronic Components

Click to view similar products for [Schottky Diodes & Rectifiers](#) category:

Click to view products by [Agertech](#) manufacturer:

Other Similar products are found below :

[MA4E2039](#) [MA4E2508M-1112](#) [MBR10100CT-BP](#) [MBR1545CT](#) [MMBD301M3T5G](#) [RB160M-50TR](#) [BAS16E6433HTMA1](#) [BAS 3010S-02LRH E6327](#) [BAT 54-02LRH E6327](#) [IDL02G65C5XUMA1](#) [NSR05F40QNXT5G](#) [NSVR05F40NXT5G](#) [NTE555](#) [JANS1N6640](#) [SB07-03C-TB-H](#) [SK310-T](#) [SK33A-TP](#) [SK34B-TP](#) [SS3003CH-TL-E](#) [PDS3100Q-7](#) [GA01SHT18](#) [CRS10I30A\(TE85L,QM](#) [MA4E2501L-1290](#) [MBRB30H30CT-1G](#) [JANTX1N5712-1](#) [SB007-03C-TB-E](#) [SK33B-TP](#) [SK35A-TP](#) [SK38B-LTP](#) [NTE505](#) [NTSB30U100CT-1G](#) [VS-6CWQ10FNHM3](#) [CRG04\(T5L,TEMQ\)](#) [ACDBA1100LR-HF](#) [ACDBA1200-HF](#) [ACDBA240-HF](#) [ACDBA3100-HF](#) [CDBQC0530L-HF](#) [ACDBA260LR-HF](#) [ACDBA1100-HF](#) [MA4E2502L-1246](#) [10BQ015-M3/5BT](#) [10BQ060-M3/5BT](#) [NRVB130LSFT1G](#) [CRS08TE85LQM](#) [PMAD1108-LF](#) [B120Q-13-F](#) [1N5819T-G](#) [B0530WSQ-7-F](#) [PDS1040Q-13](#)