

# SS32F-AT THRU SS320F-AT

## Surface Mount Schottky Barrier Rectifier

Reverse Voltage - 20 to 200 V      Forward Current - 3.0A

### Features

- ◆ Metal silicon junction, majority carrier conduction
- ◆ For surface mounted applications
- ◆ Low power loss, high efficiency
- ◆ High forward surge current capability
- ◆ For use in low voltage, high frequency inverters, free wheeling, and polarity protection applications

### PINNING

PIN	DESCRIPTION
1	Cathode
2	Anode

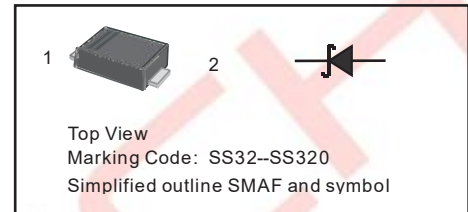

### MECHANICAL DATA

- ◆ Case: SMAF
- ◆ Terminals: Solderable per MIL-STD-750, Method 2026
- ◆ Approx. Weight: 27mg / 0.00095oz

### Absolute Maximum Ratings and Electrical characteristics

Ratings at 25 °C ambient temperature unless otherwise specified. Single phase, half wave, 60Hz resistive or inductive load, for capacitive load, derate by 20 %

Parameter	Symbols	SS32F-AT	SS34F-AT	SS34AF-AT	SS36F-AT	SS38F-AT	SS310F-AT	SS312F-AT	SS315F-AT	SS320F-AT	Units
Maximum Repetitive Peak Reverse Voltage	$V_{RRM}$	20	40	45	60	80	100	120	150	200	V
Maximum RMS voltage	$V_{RMS}$	14	28	31.5	42	56	70	84	105	140	V
Maximum DC Blocking Voltage	$V_{DC}$	20	40	45	60	80	100	120	150	200	V
Maximum Average Forward Rectified Current	$I_{F(AV)}$	3.0									A
Peak Forward Surge Current, 8.3ms Single Half Sine-wave Superimposed on Rated Load (JEDEC method)	$I_{FSM}$	80									A
Max Instantaneous Forward Voltage at 3A	$V_F$	0.55	0.70			0.85	0.95				V
Maximum DC Reverse Current $T_a = 25^\circ\text{C}$ at Rated DC Reverse Voltage $T_a = 100^\circ\text{C}$	$I_R$	0.5 5			0.3 3					mA	
Typical Junction Capacitance <sup>(1)</sup>	$C_j$	250			180					pF	
Typical Thermal Resistance <sup>(2)</sup>	$R_{\theta JA}$ $R_{\theta JC}$	70 18								°C/W	
Operating Junction Temperature Range	$T_j$	-55 ~ +150									°C
Storage Temperature Range	$T_{stg}$	-55 ~ +150									°C

(1) Measured at 1 MHz and applied reverse voltage of 4 VD.C

(2) P.C.B. mounted with 2.0" X 2.0" (5 X 5 cm) copper pad areas.

# SS32F-AT THRU SS320F-AT

## Typical Characteristics Curves

Fig.1 Forward Current Derating Curve

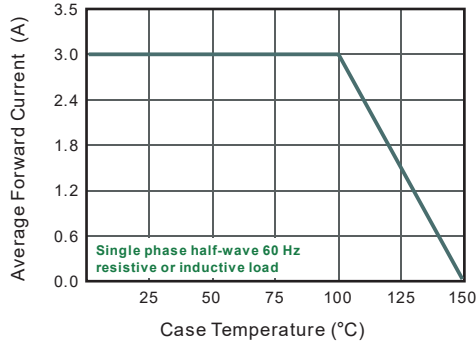

Fig.2 Typical Reverse Characteristics

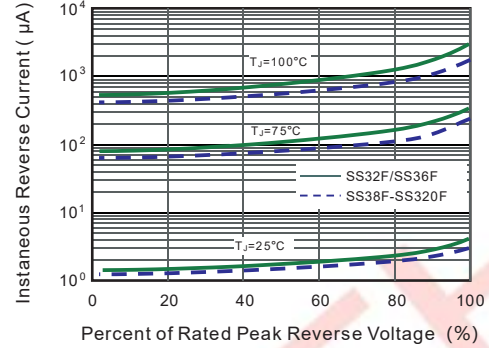

Fig.3 Typical Forward Characteristic

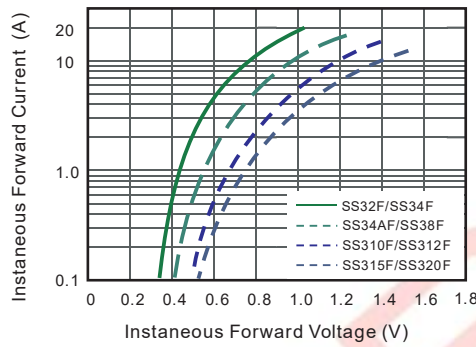

Fig.4 Typical Junction Capacitance

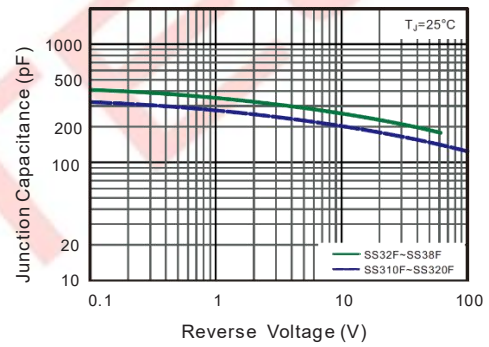

Fig.5 Maximum Non-Repetitive Peak Forward Surge Current

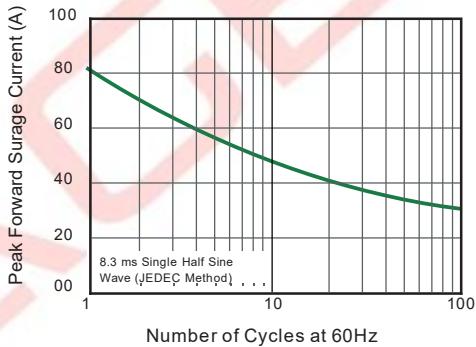
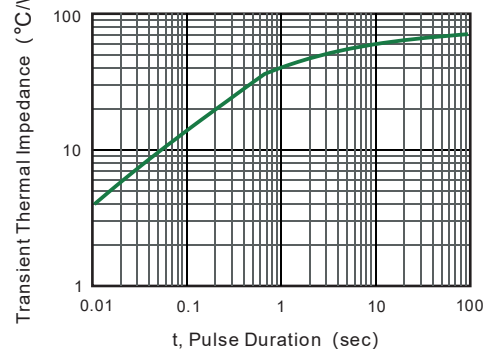

Fig.5- Typical Transient Thermal Impedance



# SS32F-AT THRU SS320F-AT

## Package Outline

SMAF

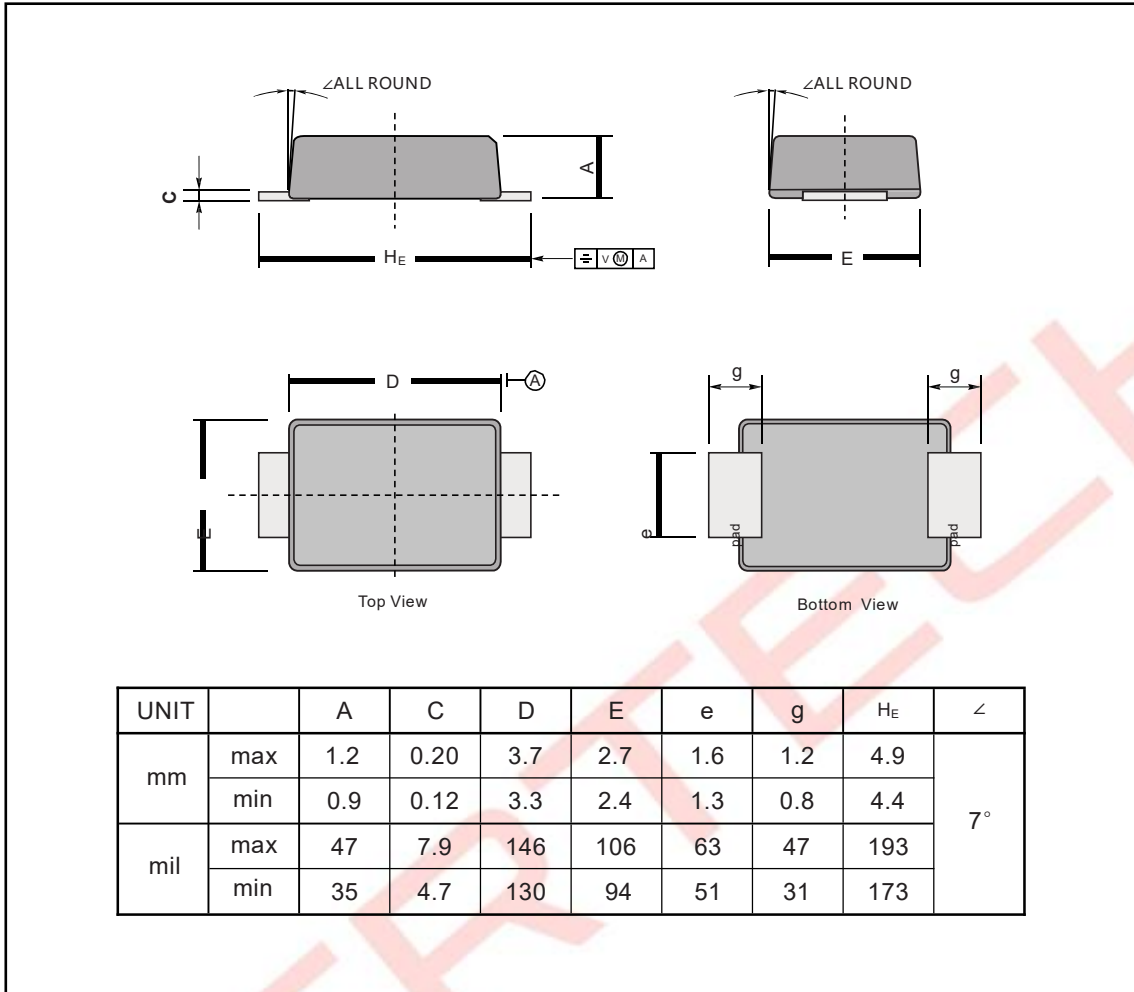

### The recommended mounting pad size

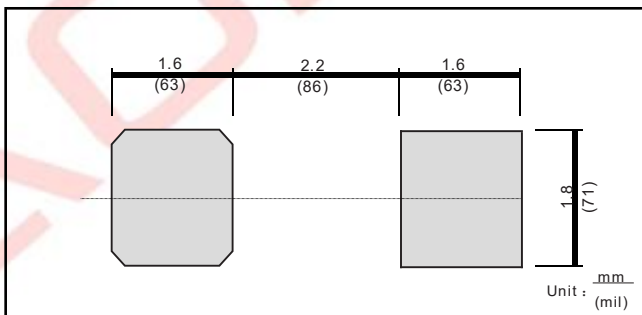

### Marking

Type number	Marking code
SS32F-AT	SS32
SS34F-AT	SS34
SS34AF-AT	SS34A
SS36F-AT	SS36
SS38F-AT	SS38
SS310F-AT	SS310
SS312F-AT	SS312
SS315F-AT	SS315
SS320F-AT	SS320

## X-ON Electronics

Largest Supplier of Electrical and Electronic Components

*Click to view similar products for [Schottky Diodes & Rectifiers](#) category:*

*Click to view products by [Agertech](#) manufacturer:*

Other Similar products are found below :

[MA4E2039](#) [MA4E2508M-1112](#) [MBR10100CT-BP](#) [MBR1545CT](#) [MMBD301M3T5G](#) [RB160M-50TR](#) [BAS16E6433HTMA1](#) [BAS 3010S-02LRH E6327](#) [BAT 54-02LRH E6327](#) [IDL02G65C5XUMA1](#) [NSR05F40QNXT5G](#) [NSVR05F40NXT5G](#) [NTE555](#) [JANS1N6640](#) [SB07-03C-TB-H](#) [SK310-T](#) [SK33A-TP](#) [SK34B-TP](#) [SS3003CH-TL-E](#) [PDS3100Q-7](#) [GA01SHT18](#) [CRS10I30A\(TE85L,QM](#) [MA4E2501L-1290](#) [MBRB30H30CT-1G](#) [JANTX1N5712-1](#) [SB007-03C-TB-E](#) [SK33B-TP](#) [SK35A-TP](#) [SK38B-LTP](#) [NTE505](#) [NTSB30U100CT-1G](#) [VS-6CWQ10FNHM3](#) [CRG04\(T5L,TEMQ\)](#) [ACDBA1100LR-HF](#) [ACDBA1200-HF](#) [ACDBA240-HF](#) [ACDBA3100-HF](#) [CDBQC0530L-HF](#) [ACDBA260LR-HF](#) [ACDBA1100-HF](#) [MA4E2502L-1246](#) [10BQ015-M3/5BT](#) [10BQ060-M3/5BT](#) [NRVB130LSFT1G](#) [CRS08TE85LQM](#) [PMAD1108-LF](#) [B120Q-13-F](#) [1N5819T-G](#) [B0530WSQ-7-F](#) [PDS1040Q-13](#)