

• General Description

The AGM15T13D combines advanced trench MOSFET technology with a low resistance package to provide extremely low $R_{DS(ON)}$.

This device is ideal for load switch and battery protection applications.

• Features

- Advance high cell density Trench technology
- Low $R_{DS(ON)}$ to minimize conductive loss
- Low Gate Charge for fast switching
- Low Thermal resistance
- 100% Avalanche tested
- 100% DVDS tested

• Application

- MB/VGA Vcore
- SMPS 2nd Synchronous Rectifier
- POL application
- BLDC Motor driver

Product Summary

BVDSS	RDSON	ID
150V	9mΩ	75A

TO-252 Pin Configuration

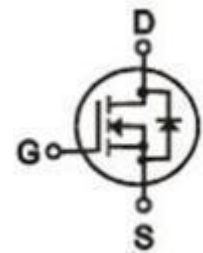
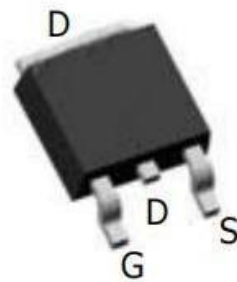

Package Marking and Ordering Information

Device Marking	Device	Device Package	Reel Size	Tape width	Quantity
AGM15T13D	AGM15T13D	TO-252	330mm	16mm	2500

Table 1. Absolute Maximum Ratings (TA=25°C)

Symbol	Parameter	Value	Unit
VDS	Drain-Source Voltage (VGS=0V)	150	V
VGS	Gate-Source Voltage (VDS=0V)	±20	V
ID	Drain Current-Continuous(Tc=25°C) (Note 1)	75	A
	Drain Current-Continuous(Tc=100°C)	60	A
IDM (pluse)	Drain Current-Continuous@ Current-Pulsed (Note 2)	320	A
PD	Maximum Power Dissipation(Tc=25°C)	125	w
	Maximum Power Dissipation(Tc=100°C)	50	w
EAS	Avalanche energy (Note 3)	576	mJ
TJ,TSTG	Operating Junction and Storage Temperature Range	-55 To 150	°C

Table 2. Thermal Characteristic

Symbol	Parameter	Typ	Max	Unit
RθJA	Thermal Resistance Junction-ambient (Steady State) ¹	---	65	°C/W
RθJC	Thermal Resistance Junction-Case ¹	---	1.0	°C/W

Table 3. Electrical Characteristics (T_J=25°C unless otherwise noted)

Symbol	Parameter	Conditions	Min	Typ	Max	Unit
On/Off States						
BVDSS	Drain-Source Breakdown Voltage	VGS=0V ID=250μA	150	--	--	V
IDSS	Zero Gate Voltage Drain Current	VDS=150V,VGS=0V	--	--	1.0	μA
IGSS	Gate-Body Leakage Current	VGS=±20V,VDS=0V	--	--	±100	nA
VGS(th)	Gate Threshold Voltage	VDS=VGS,ID=250μA	2.0	3.2	4.0	V
gFS	Forward Transconductance	VDS=5V,ID=15A	--	24	--	S
RDS(on)	Drain-Source On-State Resistance	VGS=10V, ID=20A	--	9.0	11.5	mΩ
Dynamic Characteristics						
Ciss	Input Capacitance	VDS=75V,VGS=0V, F=1MHZ	--	2181	--	pF
Coss	Output Capacitance		--	363	--	pF
Crss	Reverse Transfer Capacitance		--	7.9	--	pF
Rg	Gate resistance	VGS=0V, VDS=0V,f=1.0MHz	--	2.5	--	Ω
Switching Times						
td(on)	Turn-on Delay Time	VGS=10V,VDS=75V RGEN=6Ω RL=3.75Ω	--	30	--	nS
tr	Turn-on Rise Time		--	19.4	--	nS
td(off)	Turn-Off Delay Time		--	7.5	--	nS
tf	Turn-Off Fall Time		--	6.5	--	nS
Qg	Total Gate Charge	VGS=10V, VDS=75V, ID=20A	--	30	--	nC
Qgs	Gate-Source Charge		--	7.5	--	nC
Qgd	Gate-Drain Charge		--	6.5	--	nC
Source-Drain Diode Characteristics						
ISD	Source-Drain Current(Body Diode)		--	--	75	A
VSD	Forward on Voltage	VGS=0V,IS=20A	--	--	1.2	V
trr	Reverse Recovery Time	IS=20A , di/dt=100A/μs , TJ=25°C	--	99	--	ns
Qrr	Reverse Recovery Charge		--	318	--	nc

Notes 1.The maximum current rating is package limited.

Notes 2.Repetitive Rating: Pulse width limited by maximum junction temperature

Notes 3.EAS condition: T_J=25°C,VDD=50V,Vgs=10V , ID=48A, L=0.5mH,RG=25ohm

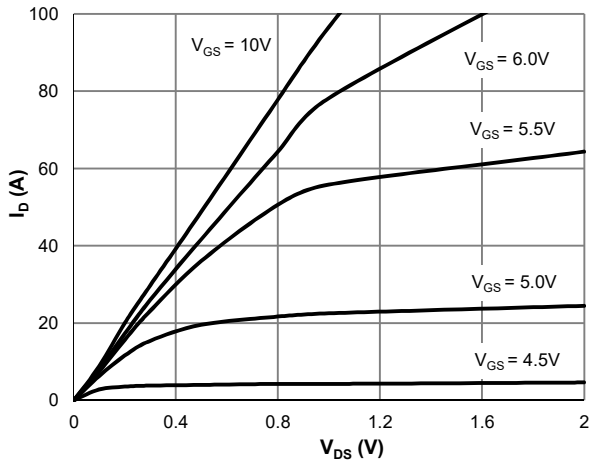
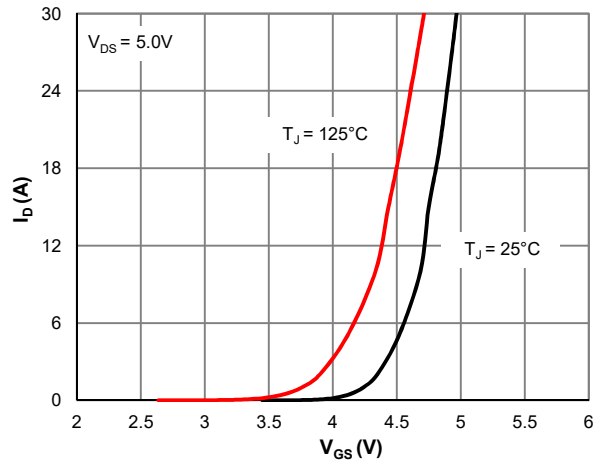
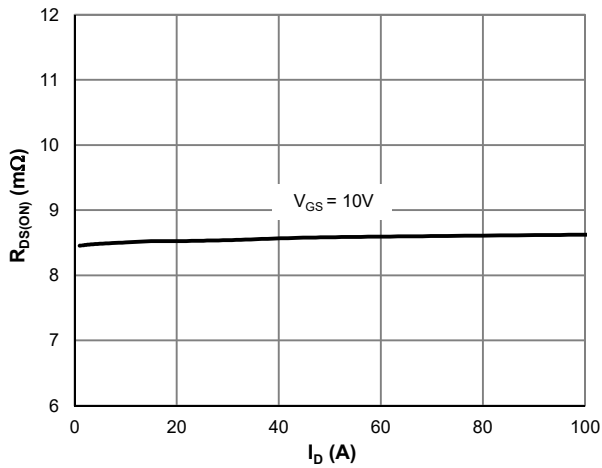
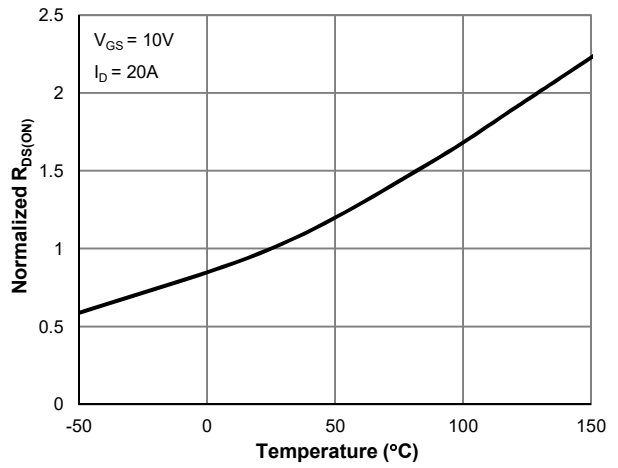
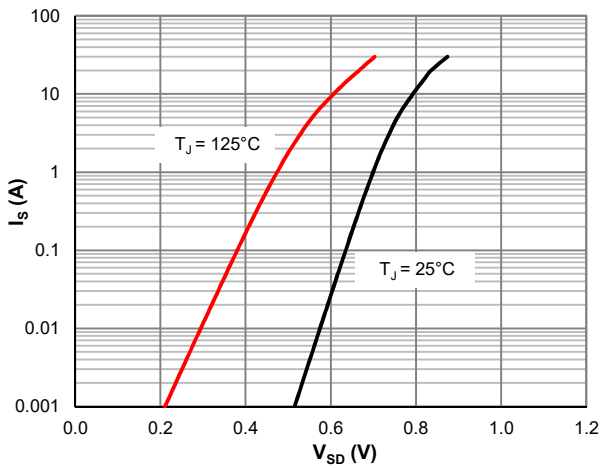
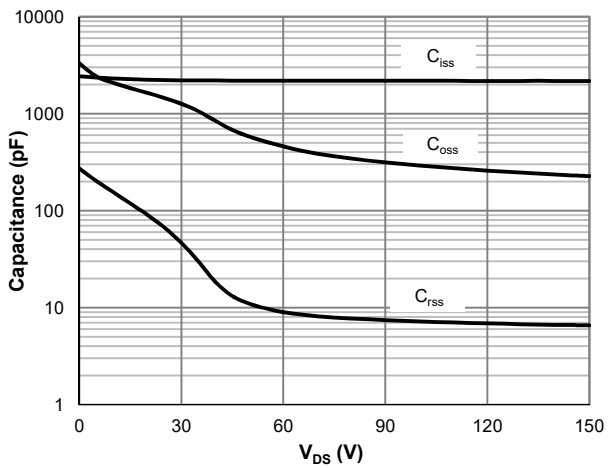
Typical Electrical & Thermal Characteristics

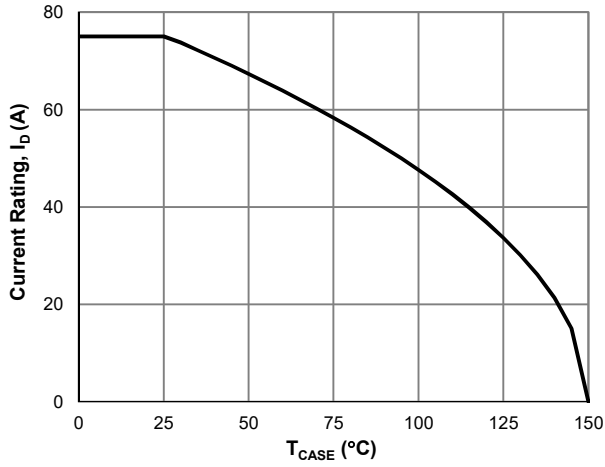
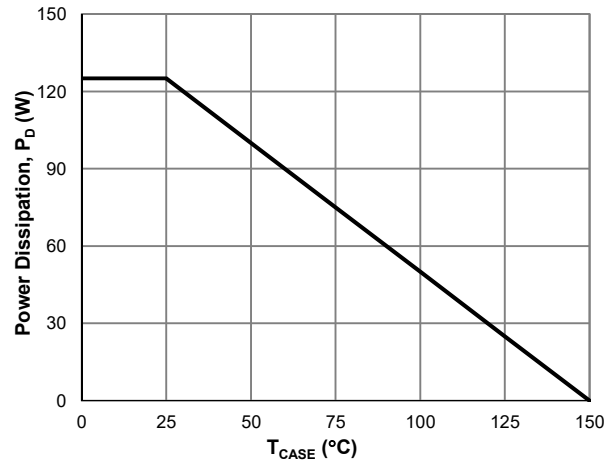
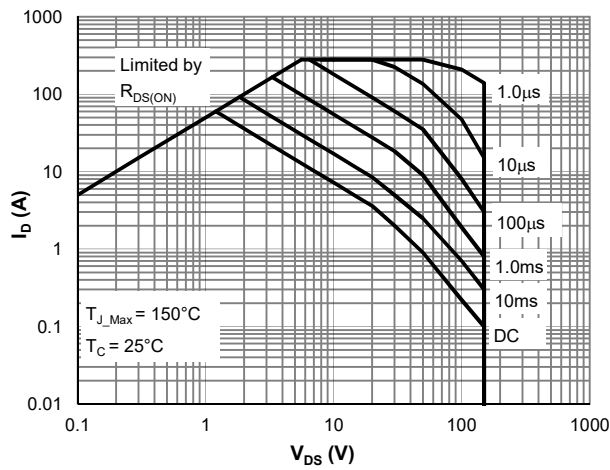
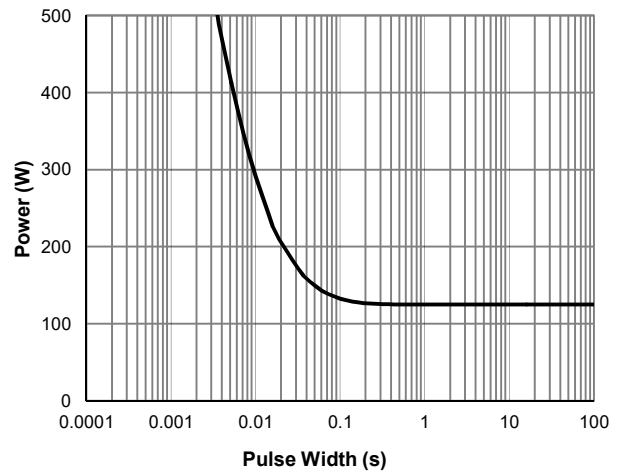
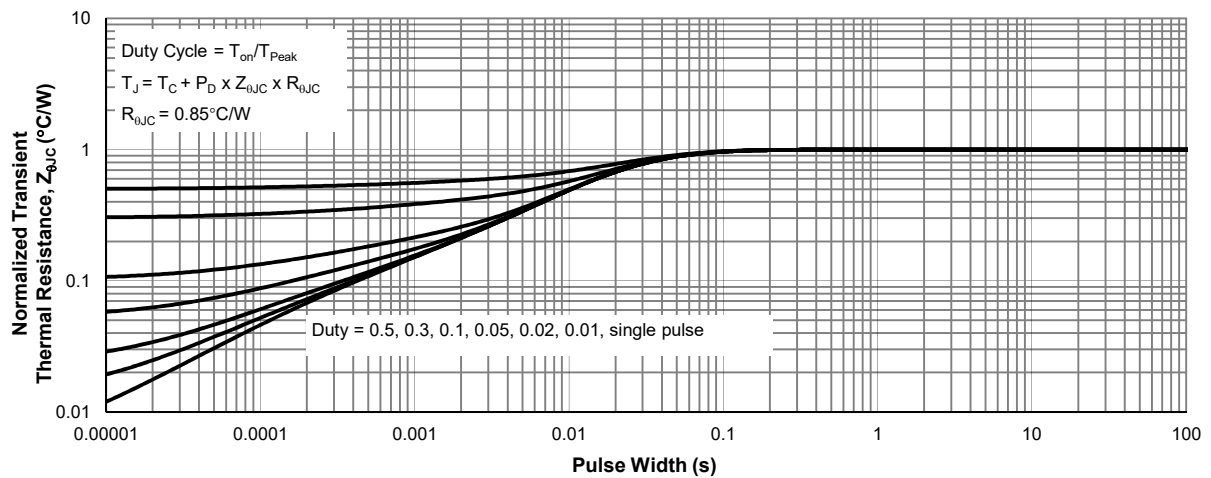
Figure 1: Saturation Characteristics

Figure 2: Transfer Characteristics

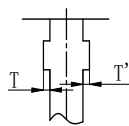
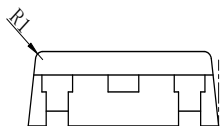
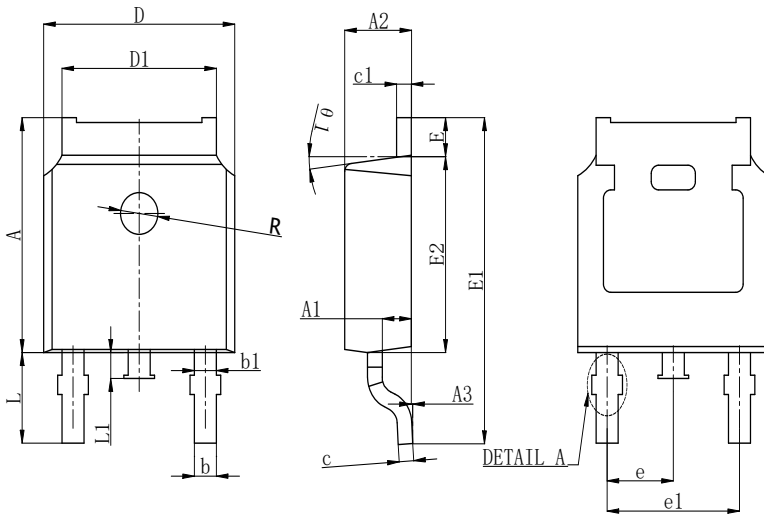
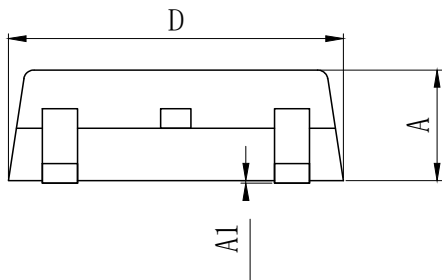
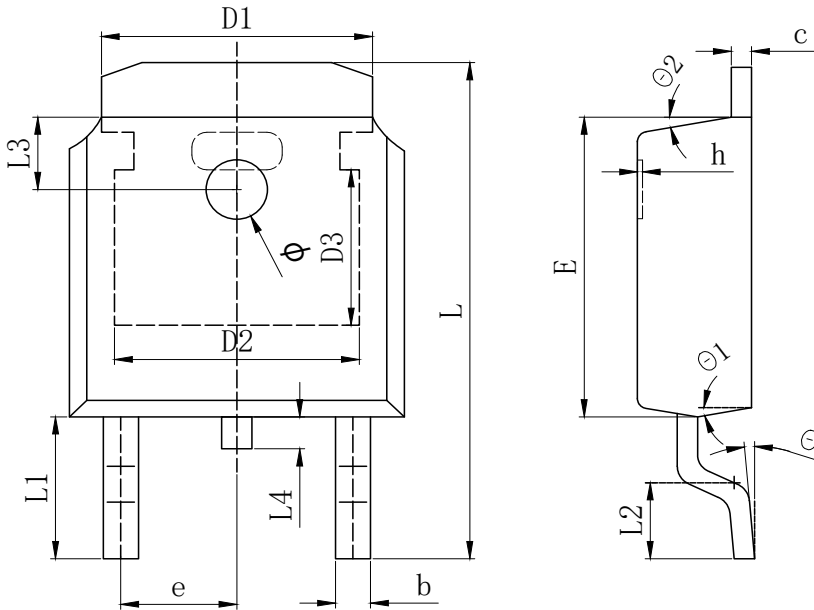
Figure 3: $R_{DS(ON)}$ vs. Drain Current

Figure 4: $R_{DS(ON)}$ vs. Junction Temperature

Figure 5: Body-Diode Characteristics

Figure 6: Capacitance Characteristics

Typical Electrical & Thermal Characteristics

Figure 7: Current De-rating

Figure 8: Power De-rating

Figure 9: Maximum Safe Operating Area

Figure 10: Single Pulse Power Rating, Junction-to-Case

Figure 11: Normalized Maximum Transient Thermal Impedance

TO-252 Package Outline Data



$0 < T, T' < 0.12$
DETAIL A

SYMBOL	MILLIMETER		
	MIN	Typ.	MAX
A	2.200	2.300	2.400
A1	0.000		0.127
b	0.640	0.690	0.740
c (电镀后)	0.460	0.520	0.580
D	6.500	6.600	6.700
D1	5.334 REF		
D2	4.826 REF		
D3	3.166 REF		
E	6.000	6.100	6.200
e	2.286 TYP		
h	0.000	0.100	0.200
L	9.900	10.100	10.300
L1	2.888 REF		
L2	1.400	1.550	1.700
L3	1.600 REF		
L4	0.600	0.800	1.000
Φ	1.100	1.200	1.300
θ	0°		8°
θ 1	9° TYP		
θ 2	9° TYP		

SYMBOL	MILLIMETER		
	MIN	NOM	MAX
A	7.050	7.100	7.150
A1	0.960	1.010	1.060
A2	2.250	2.300	2.350
A3	0.000	0.050	0.100
b	0.760REF.		
b1	1.000REF.		
c	0.508REF.		
c1	0.508REF.		
D	6.550	6.600	6.650
D1	5.220	5.320	5.420
E	0.950	1.000	1.050
E1	9.700	9.900	10.100
E2	6.050	6.100	6.150
e	2.286BSC		
e1	4.572REF.		
L	2.650	2.800	2.950
L1	0.700	0.800	0.900
θ 1	7° REF.		
R	1.300REF.		
R1	0.250REF.		

Disclaimer:

The information provided in this document is believed to be accurate and reliable. however, Shenzhen Core Control Electronics Technology Co., Ltd. does not assume any responsibility for the following consequences. Do not consider the use of such information or use beyond its scope.

The information mentioned in this document may be changed at any time without notice.

The products and information provided in this document do not infringe patents. Shenzhen Core Control Electronics Technology Co., Ltd. assumes no responsibility for any infringement of any other rights of third parties. The result of using such products and information.

This document is the first version issued on August 10th, 2023. This document replaces all previously provided information.

 It is a registered trademark of Shenzhen Core Control Electronics Technology Co., Ltd.

Copyright © 2017 Shenzhen Core Control Electronics Technology Co., Ltd. all rights reserved.

X-ON Electronics

Largest Supplier of Electrical and Electronic Components

Click to view similar products for [MOSFET](#) category:

Click to view products by [AGM-Semi](#) manufacturer:

Other Similar products are found below :

[IRFD120](#) [JANTX2N5237](#) [BUK455-60A/B](#) [MIC4420CM-TR](#) [VN1206L](#) [NDP4060](#) [SI4482DY](#) [IPS70R2K0CEAKMA1](#) [SQD23N06-31L-GE3](#)
[TK16J60W,S1VQ\(O](#) [2SK2614\(TE16L1,Q\)](#) [DMN1017UCP3-7](#) [DMN1053UCP4-7](#) [SQJ469EP-T1-GE3](#) [NTE2384](#) [DMC2700UDMQ-7](#)
[DMN2080UCB4-7](#) [DMN61D9UWQ-13](#) [US6M2GTR](#) [DMN31D5UDJ-7](#) [DMP22D4UFO-7B](#) [DMN1006UCA6-7](#) [DMN16M9UCA6-7](#)
[STF5N65M6](#) [IRF40H233XTMA1](#) [STU5N65M6](#) [DMN6022SSD-13](#) [DMN13M9UCA6-7](#) [DMTH10H4M6SPS-13](#) [DMN2990UFB-7B](#)
[IPB80P04P405ATMA2](#) [2N7002W-G](#) [MCAC30N06Y-TP](#) [MCQ7328-TP](#) [BXP7N65D](#) [BXP4N65F](#) [AOL1454G](#) [WMJ80N60C4](#) [BXP2N20L](#)
[BXP2N65D](#) [BXT1150N10J](#) [BXT1700P06M](#) [TSM60NB380CP](#) [ROG](#) [RQ7L055BGTCR](#) [DMNH15H110SK3-13](#) [SLF10N65ABV2](#)
[BSO203SP](#) [BSO211P](#) [IPA60R230P6](#) [IPA60R460CE](#)