

### ● General Description

The AGM30P20AP combines advanced trench MOSFET technology with a low resistance package to provide extremely low  $R_{DS(ON)}$ .

This device is ideal for load switch and battery protection applications.

### ● Features

- Advance high cell density Trench technology
- Low  $R_{DS(ON)}$  to minimize conductive loss
- Low Gate Charge for fast switching
- Low Thermal resistance
- 100% Avalanche tested
- 100% DVDS tested

### ● Application

- MB/VGA Vcore
- SMPS 2<sup>nd</sup> Synchronous Rectifier
- POL application
- BLDC Motor driver

### Product Summary

BVDSS	RDSON	ID
-30V	18mΩ	-18A

### PDFN3.3\*3.3 Pin Configuration

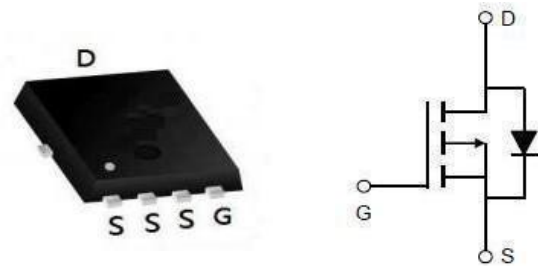

### Package Marking and Ordering Information

Device Marking	Device	Device Package	Reel Size	Tape width	Quantity
AGM30P20AP	AGM30P20AP	PDFN3.3*3.3	330mm	12mm	5000

Table 1. Absolute Maximum Ratings ( $T_c=25^\circ\text{C}$ )

Symbol	Parameter	Value	Unit
VDS	Drain-Source Voltage ( $V_{GS}=0V$ )	-30	V
VGS	Gate-Source Voltage ( $V_{DS}=0V$ )	$\pm 20$	V
ID	Drain Current-Continuous( $T_c=25^\circ\text{C}$ ) (Note 1)	-18	A
	Drain Current-Continuous( $T_c=100^\circ\text{C}$ )	-14	A
IDM (pulse)	Drain Current-Continuous@ Current-Pulsed (Note 2)	-72	A
PD	Maximum Power Dissipation( $T_c=25^\circ\text{C}$ )	28	w
	Maximum Power Dissipation( $T_c=100^\circ\text{C}$ )	11	w
EAS	Avalanche energy (Note 3)	65	mJ
TJ,TSTG	Operating Junction and Storage Temperature Range	-55 To 150	$^\circ\text{C}$

Table 2. Thermal Characteristic

Symbol	Parameter	Typ	Max	Unit
$R_{\theta JA}$	Thermal Resistance Junction-ambient (Steady State) <sup>1</sup>	---	40	$^\circ\text{C/W}$
$R_{\theta JC}$	Thermal Resistance Junction-Case <sup>1</sup>	---	4.4	$^\circ\text{C/W}$

**Table 2. P-Channel Electrical Characteristics (T<sub>J</sub>=25°C unless otherwise noted)**

Symbol	Parameter	Conditions	Min	Typ	Max	Unit
<b>On/Off States</b>						
BVDSS	Drain-Source Breakdown Voltage	V <sub>GS</sub> =0V I <sub>D</sub> =-250μA	-30	--	--	V
IDSS	Zero Gate Voltage Drain Current	V <sub>DS</sub> =-30V, V <sub>GS</sub> =0V	--	--	-1	μA
IGSS	Gate-Body Leakage Current	V <sub>GS</sub> =±20V, V <sub>DS</sub> =0V	--	--	±100	nA
VGS(th)	Gate Threshold Voltage	V <sub>DS</sub> =V <sub>GS</sub> , I <sub>D</sub> =-250μA	-1.2	-1.7	-2.5	V
gFS	Forward Transconductance	V <sub>DS</sub> =-10V, I <sub>D</sub> =-4A	--	6	--	S
RDS(on)	Drain-Source On-State Resistance	V <sub>GS</sub> =-10V, I <sub>D</sub> =-5A	--	18	21	mΩ
		V <sub>GS</sub> =-4.5V, I <sub>D</sub> =-4A	--	26	31	mΩ
<b>Dynamic Characteristics</b>						
Ciss	Input Capacitance	V <sub>DS</sub> =-15V, V <sub>GS</sub> =0V, F=1MHZ	--	860	--	pF
Coss	Output Capacitance		--	94	--	pF
Crss	Reverse Transfer Capacitance		--	32	--	pF
Rg	Gate resistance	V <sub>GS</sub> =0V, V <sub>DS</sub> =0V, f=1.0MHz	--	9	--	Ω
<b>Switching Times</b>						
td(on)	Turn-on Delay Time	V <sub>GS</sub> =-10V, V <sub>DS</sub> =-15V, I <sub>D</sub> =-15A, RGEN=3.3Ω	--	8	--	nS
tr	Turn-on Rise Time		--	18	--	nS
td(off)	Turn-Off Delay Time		--	31.8	--	nS
tf	Turn-Off Fall Time		--	18.4	--	nS
Qg	Total Gate Charge	V <sub>GS</sub> =-10V, V <sub>DS</sub> =-25V, I <sub>D</sub> =-12A	--	12	--	nC
Qgs	Gate-Source Charge		--	2.0	--	nC
Qgd	Gate-Drain Charge		--	2.9	--	nC
<b>Source-Drain Diode Characteristics</b>						
ISD	Source-Drain Current(Body Diode)		--	--	-18	A
VSD	Forward on Voltage	V <sub>GS</sub> =0V, I <sub>S</sub> =-5A	--	--	-1.2	V
trr	Reverse Recovery Time	I <sub>F</sub> =-5A , di/dt=100A/μs , T <sub>J</sub> =25°C	--	--	--	ns
Qrr	Reverse Recovery Charge		--	--	--	nc

Notes 1.The maximum current rating is package limited.

Notes2.Repetitive Rating: Pulsewidth limited by maximum junction temperature Notes

3.EAS condition: T<sub>J</sub>=25°C

Characteristics Curve:

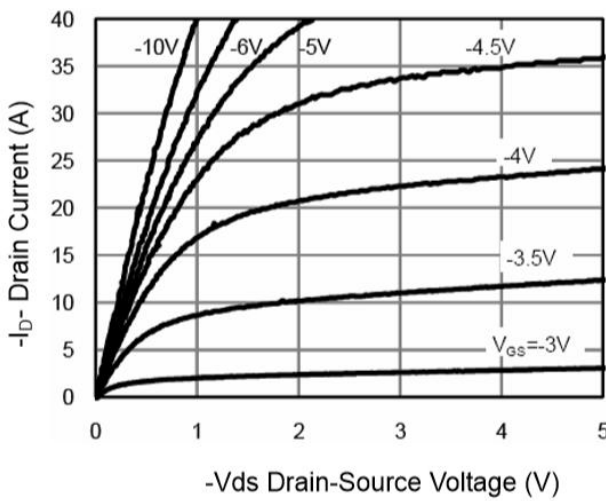
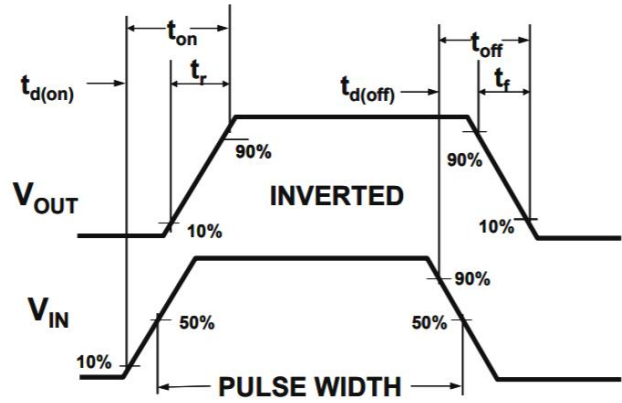
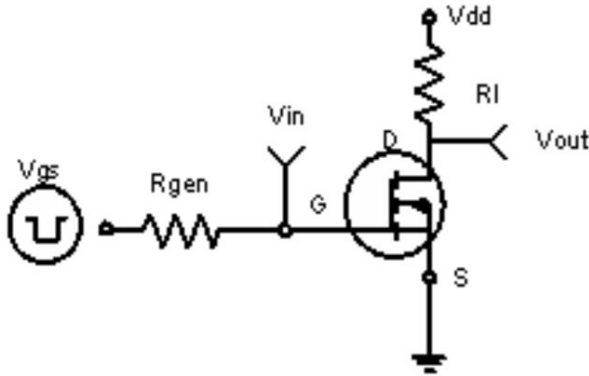

Figure 1 Output Characteristics

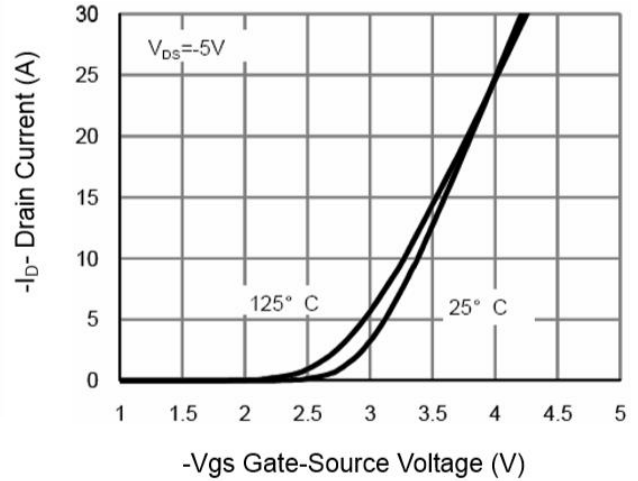

Figure 2 Transfer Characteristics

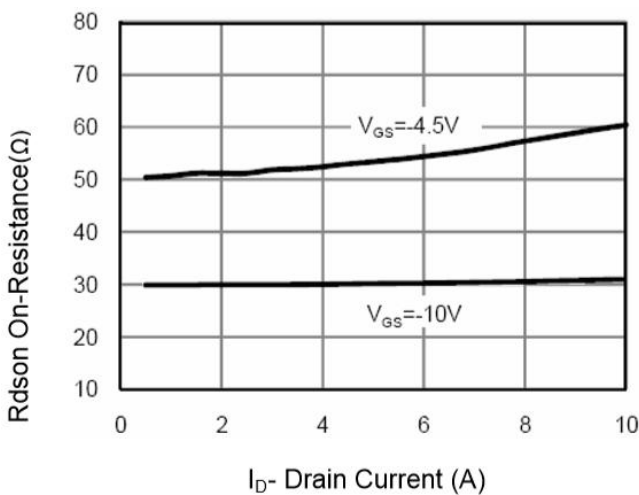

Figure 3 Rdson- Drain Current

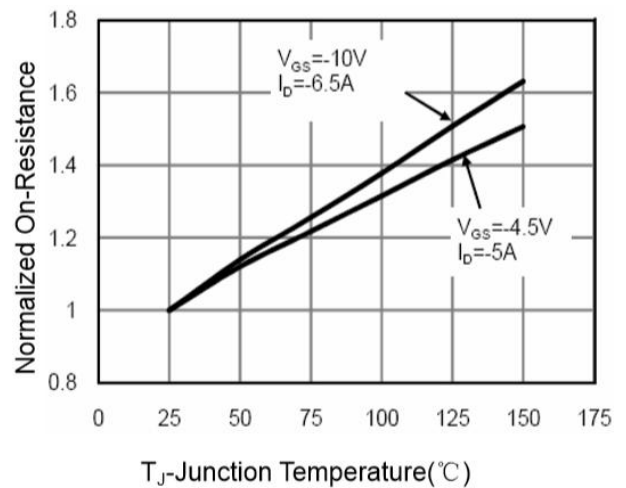

Figure 4 Rdson-Junction Temperature

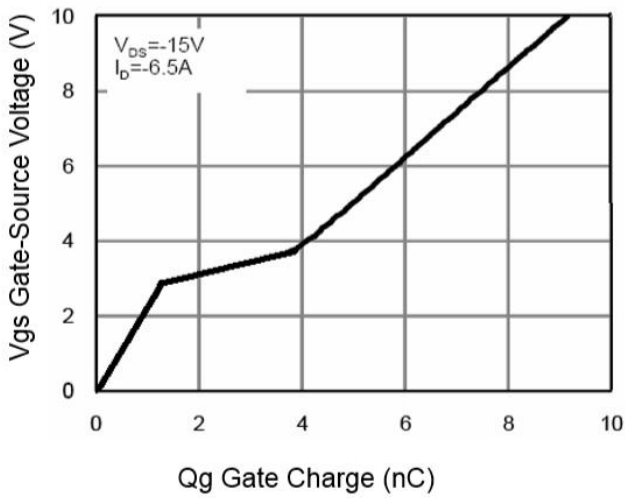

Figure 5 Gate Charge

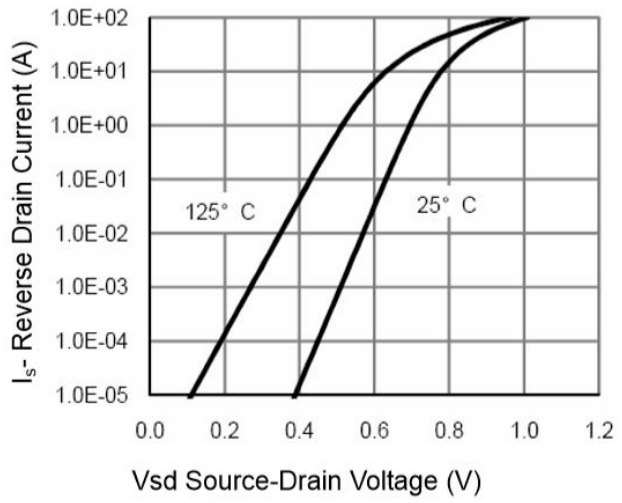

Figure 6 Source- Drain Diode Forward

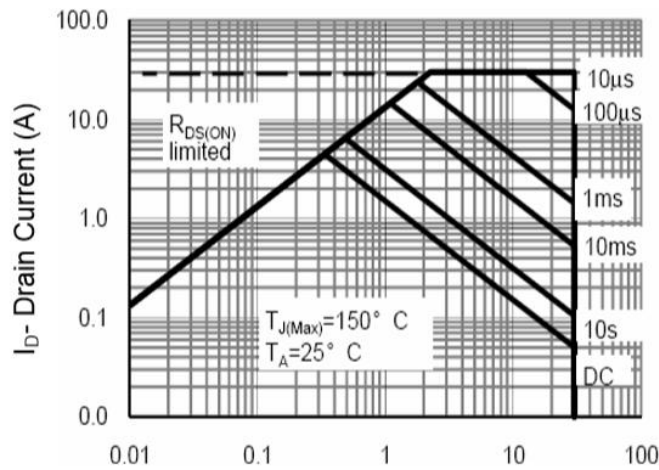

Figure 7 Safe Operation Area

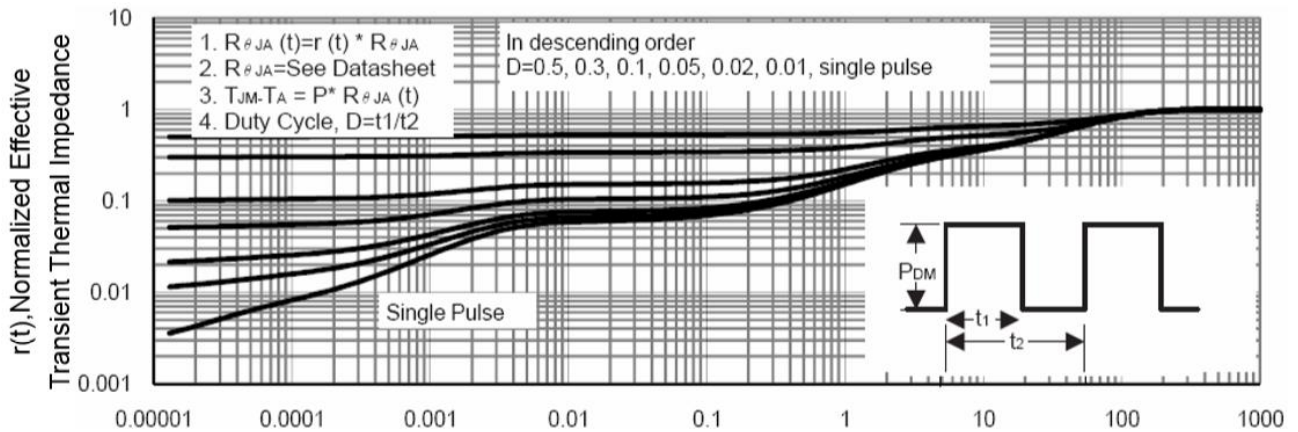
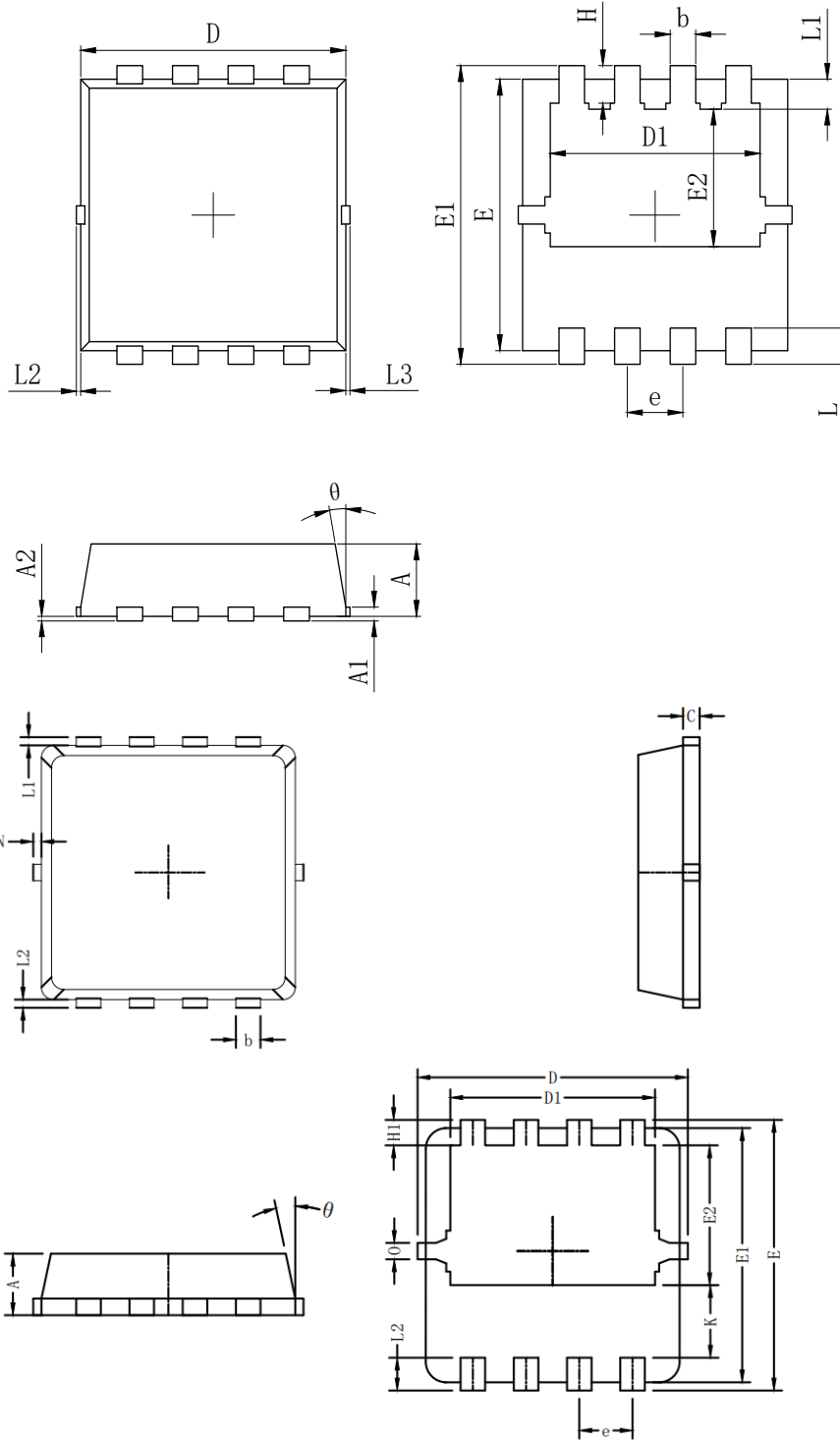

Figure 8 Normalized Maximum Transient Thermal Impedance

**●Dimensions (PDFN3.3×3.3)**

SYMBOL	MILLIMETER		
	MIN	Typ.	MAX
A	0.700	0.800	0.900
A1	0.152 REF.		
A2	0°0.05		
D	3.000	3.100	3.200
D1	2.300	2.450	2.600
E	2.900	3.000	3.100
E1	3.150	3.300	3.450
E2	1.320	1.520	1.720
b	0.200	0.300	0.400
e	0.550	0.650	0.750
L	0.300	0.400	0.500
L1	0.180	0.330	0.480
L2	0°0.100		
L3	0°0.100		
H	0.315	0.415	0.515
$\theta$	8°	10°	12°

Symbols	Millimeters		
	MIN.	NOM.	MAX.
A	0.65	0.75	0.85
b	0.25	0.30	0.35
C	0.15	0.20	0.25
D	3.00	3.10	3.20
D1	2.40	2.50	2.60
E	3.20	3.30	3.40
E1	3.00	3.10	3.20
E2	1.60	1.70	1.80
e	0.65 BSC.		
H1	0.21	0.31	0.41
H2	0.30	0.40	0.50
K	0.78	0.88	0.98
L1/L2	0.10 REF.		
$\theta$	11°	12°	13°
N	0	-	0.15
0	0.2 REF.		

Disclaimer:

The information provided in this document is believed to be accurate and reliable. however, Shenzhen Core Control Electronics Technology Co., Ltd. does not assume any responsibility for the following consequences. Do not consider the use of such information or use beyond its scope.

The information mentioned in this document may be changed at any time without notice.

The products and information provided in this document do not infringe patents. Shenzhen Core Control Electronics Technology Co., Ltd. assumes no responsibility for any infringement of any other rights of third parties. The result of using such products and information.

This document is the fourth version issued on July 10th, 2023. This document replaces all previously provided information.

 It is a registered trademark of Shenzhen Core Control Electronics Technology Co., Ltd.

Copyright © 2017 Shenzhen Core Control Electronics Technology Co., Ltd. all rights reserved.

## X-ON Electronics

Largest Supplier of Electrical and Electronic Components

*Click to view similar products for [MOSFET](#) category:*

*Click to view products by [AGM-Semi](#) manufacturer:*

Other Similar products are found below :

[IRFD120](#) [JANTX2N5237](#) [BUK455-60A/B](#) [MIC4420CM-TR](#) [VN1206L](#) [NDP4060](#) [SI4482DY](#) [IPS70R2K0CEAKMA1](#) [SQD23N06-31L-GE3](#)  
[TK16J60W,S1VQ\(O](#) [2SK2614\(TE16L1,Q\)](#) [DMN1017UCP3-7](#) [DMN1053UCP4-7](#) [SQJ469EP-T1-GE3](#) [NTE2384](#) [DMC2700UDMQ-7](#)  
[DMN2080UCB4-7](#) [DMN61D9UWQ-13](#) [US6M2GTR](#) [DMN31D5UDJ-7](#) [DMP22D4UFO-7B](#) [DMN1006UCA6-7](#) [DMN16M9UCA6-7](#)  
[STF5N65M6](#) [IRF40H233XTMA1](#) [STU5N65M6](#) [DMN6022SSD-13](#) [DMN13M9UCA6-7](#) [DMTH10H4M6SPS-13](#) [DMN2990UFB-7B](#)  
[IPB80P04P405ATMA2](#) [2N7002W-G](#) [MCAC30N06Y-TP](#) [MCQ7328-TP](#) [NTMC083NP10M5L](#) [NVMFS2D3P04M8LT1G](#) [BXP7N65D](#)  
[BXP4N65F](#) [AOL1454G](#) [WMJ80N60C4](#) [BXP2N20L](#) [BXP2N65D](#) [BXT1150N10J](#) [BXT1700P06M](#) [TSM60NB380CP](#) [ROG](#) [RQ7L055BGTCR](#)  
[DMNH15H110SK3-13](#) [SLF10N65ABV2](#) [BSO203SP](#) [BSO211P](#)