

● General Description

The AGM312D combines advanced trench MOSFET technology with a low resistance package to provide extremely low $R_{DS(ON)}$.

This device is ideal for load switch and battery protection applications.

● Features

- Advance high cell density Trench technology
- Low $R_{DS(ON)}$ to minimize conductive loss
- Low Gate Charge for fast switching
- Low Thermal resistance
- 100% Avalanche tested
- 100% DVDS tested

● Application

- MB/VGA Vcore
- SMPS 2nd Synchronous Rectifier
- POL application
- BLDC Motor driver

Product Summary

| BVDSS | RDSON | ID |
|-------|-------|-----|
| 30V | 14mΩ | 20A |

TO-252 Pin Configuration

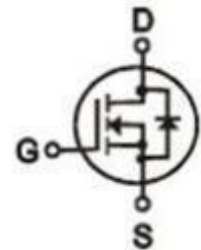
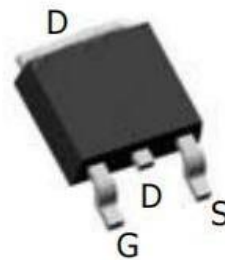

Package Marking and Ordering Information

| Device Marking | Device | Device Package | Reel Size | Tape width | Quantity |
|----------------|---------|----------------|-----------|------------|----------|
| AGM312D | AGM312D | TO-252 | 330mm | 16mm | 2500 |

Table 1. Absolute Maximum Ratings (TA=25°C)

| Symbol | Parameter | Value | Unit |
|-------------|---|------------|------|
| VDS | Drain-Source Voltage (VGS=0V) | 30 | V |
| VGS | Gate-Source Voltage (VDS=0V) | ±20 | V |
| ID | Drain Current-Continuous(Tc=25°C) (Note 1) | 20 | A |
| | Drain Current-Continuous(Tc=100°C) | 14 | A |
| IDM (pluse) | Drain Current-Continuous@ Current-Pulsed (Note 2) | 110 | A |
| PD | Maximum Power Dissipation(Tc=25°C) | 31 | w |
| | Maximum Power Dissipation(Tc=100°C) | 12.5 | w |
| EAS | Avalanche energy (Note 3) | 24 | mJ |
| TJ,TSTG | Operating Junction and Storage Temperature Range | -55 To 150 | °C |

Table 2. Thermal Characteristic

| Symbol | Parameter | Typ | Max | Unit |
|--------|---|-----|-----|------|
| RθJA | Thermal Resistance Junction-ambient (Steady State) ¹ | --- | 50 | °C/W |
| RθJC | Thermal Resistance Junction-Case ¹ | --- | 4 | °C/W |

Table 3. Electrical Characteristics (T_j=25°C unless otherwise noted)

| Symbol | Parameter | Conditions | Min | Typ | Max | Unit |
|---|----------------------------------|-------------------------------------|-----|-----|------|------|
| On/Off States | | | | | | |
| BVDSS | Drain-Source Breakdown Voltage | VGS=0V ID=250μA | 30 | -- | -- | V |
| IDSS | Zero Gate Voltage Drain Current | VDS=30V,VGS=0V | -- | -- | 1.0 | μA |
| IGSS | Gate-Body Leakage Current | VGS=±20V,VDS=0V | -- | -- | ±100 | nA |
| VGS(th) | Gate Threshold Voltage | VDS=VGS,ID=250μA | 1.0 | 1.5 | 2.5 | V |
| gFS | Forward Transconductance | VDS=5V,ID=10A | -- | 34 | -- | S |
| RDS(on) | Drain-Source On-State Resistance | VGS=10V, ID=15A | -- | 14 | 20 | mΩ |
| | | VGS=4.5V, ID=10A | -- | 20 | 28.5 | mΩ |
| Dynamic Characteristics | | | | | | |
| Ciss | Input Capacitance | VDS=15V,VGS=0V, F=1MHZ | -- | 950 | -- | pF |
| Coss | Output Capacitance | | -- | 153 | -- | pF |
| Crss | Reverse Transfer Capacitance | | -- | 129 | -- | pF |
| Rg | Gate resistance | VGS=0V, VDS=0V,f=1.0MHz | -- | -- | -- | Ω |
| Switching Times | | | | | | |
| td(on) | Turn-on Delay Time | VGS=10V,VDS=15V ID=15A,RGEN=3.3Ω | -- | 5 | -- | nS |
| tr | Turn-on Rise Time | | -- | 9 | -- | nS |
| td(off) | Turn-Off Delay Time | | -- | 32 | -- | nS |
| tf | Turn-Off Fall Time | | -- | 3.8 | -- | nS |
| Qg | Total Gate Charge | VGS=4.5V, VDS=10V, ID=15A | -- | 12 | -- | nC |
| Qgs | Gate-Source Charge | | -- | 4.5 | -- | nC |
| Qgd | Gate-Drain Charge | | -- | 3.8 | -- | nC |
| Source-Drain Diode Characteristics | | | | | | |
| ISD | Source-Drain Current(Body Diode) | VG=VD=0V , Force Current | -- | -- | 20 | A |
| VSD | Forward on Voltage | VGS=0V,IS=15A | -- | -- | 1.2 | V |
| trr | Reverse Recovery Time | IF=15A , dI/dt=100A/μs , TJ=25°C | -- | -- | -- | ns |
| Qrr | Reverse Recovery Charge | | -- | -- | -- | nc |

Notes 1.The maximum current rating is package limited.

Notes 2.Repetitive Rating: Pulse width limited by maximum junction temperature

Notes 3.EAS condition: T_J=25°C

Typical Characteristics

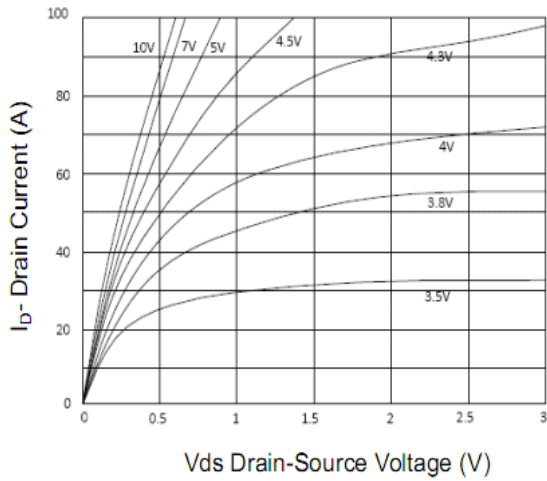

Figure 1 Output Characteristics

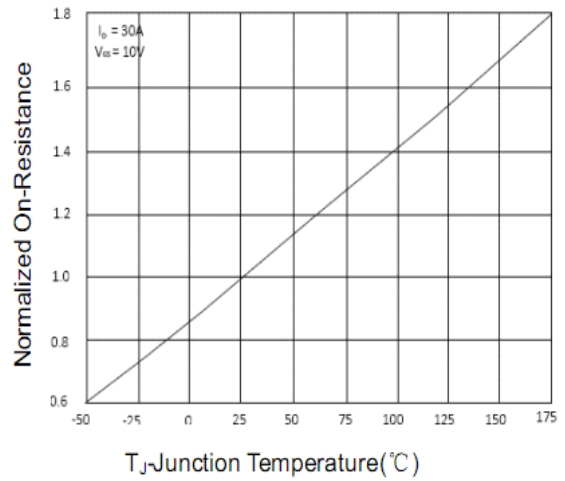

Figure 4 R_{dson} -Junction Temperature

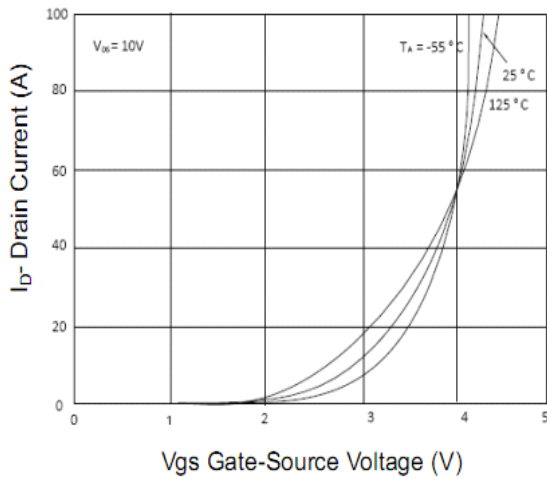

Figure 2 Transfer Characteristics

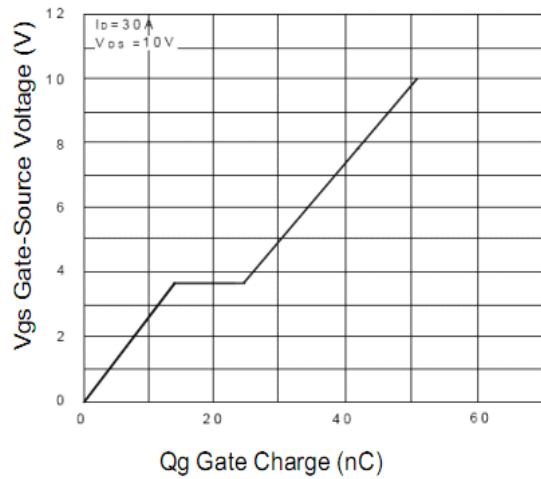
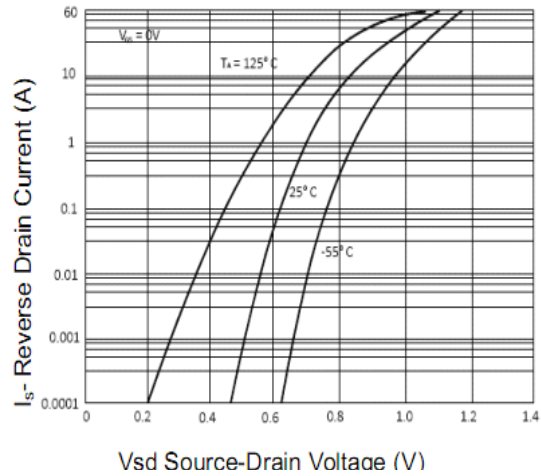
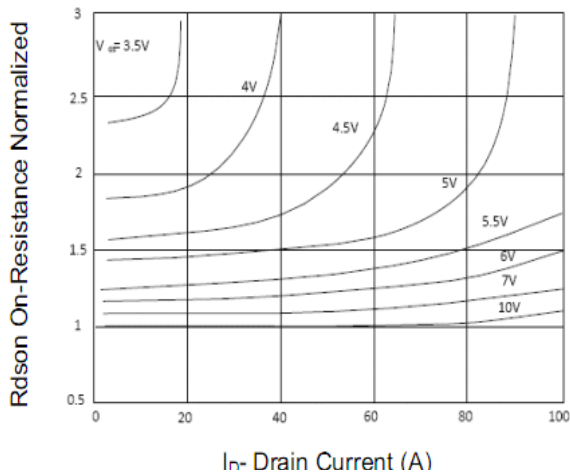
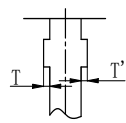
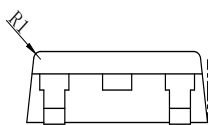
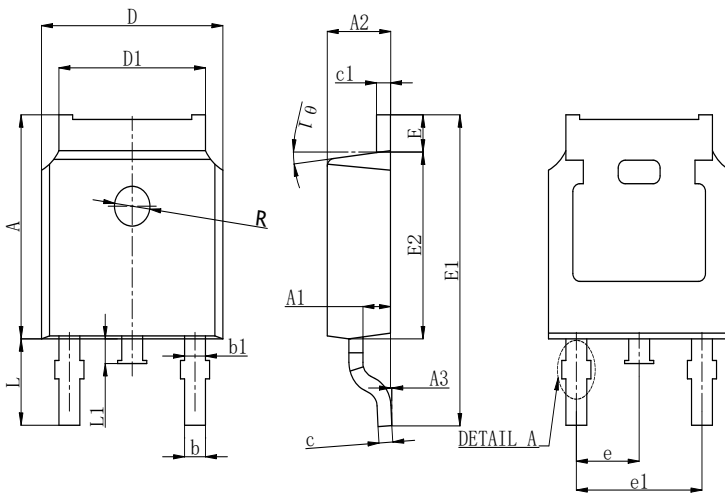
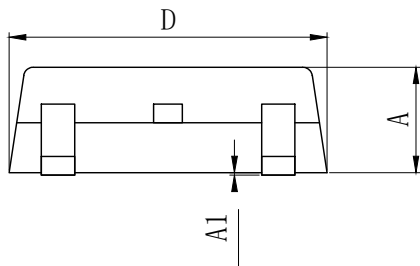
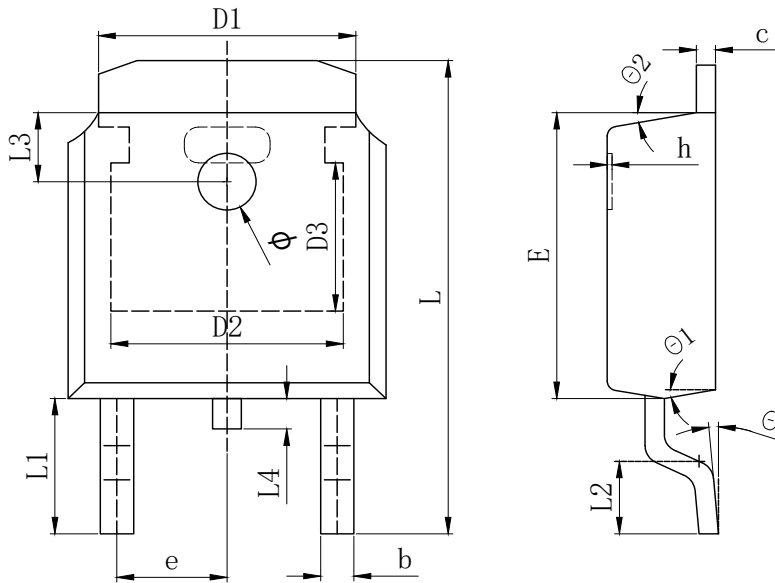

Figure 5 Gate Charge



TO-252 Package Outline Data



$0 < T, T' \leq 0.12$
 DETAIL A

| SYMBOL | MILLIMETER | | |
|--------|------------|--------|--------|
| | MIN | Typ. | MAX |
| A | 2.200 | 2.300 | 2.400 |
| A1 | 0.000 | | 0.127 |
| b | 0.640 | 0.690 | 0.740 |
| c(电镀后) | 0.460 | 0.520 | 0.580 |
| D | 6.500 | 6.600 | 6.700 |
| D1 | 5.334 REF | | |
| D2 | 4.826 REF | | |
| D3 | 3.166 REF | | |
| E | 6.000 | 6.100 | 6.200 |
| e | 2.286 TYP | | |
| h | 0.000 | 0.100 | 0.200 |
| L | 9.900 | 10.100 | 10.300 |
| L1 | 2.888 REF | | |
| L2 | 1.400 | 1.550 | 1.700 |
| L3 | 1.600 REF | | |
| L4 | 0.600 | 0.800 | 1.000 |
| φ | 1.100 | 1.200 | 1.300 |
| θ | 0° | | 8° |
| θ 1 | 9° TYP | | |
| θ 2 | 9° TYP | | |

| SYMBOL | MILLIMETER | | |
|--------|------------|-------|--------|
| | MIN | NOM | MAX |
| A | 7.050 | 7.100 | 7.150 |
| A1 | 0.960 | 1.010 | 1.060 |
| A2 | 2.250 | 2.300 | 2.350 |
| A3 | 0.000 | 0.050 | 0.100 |
| b | 0.760REF. | | |
| b1 | 1.000REF. | | |
| c | 0.508REF. | | |
| c1 | 0.508REF. | | |
| D | 6.550 | 6.600 | 6.650 |
| D1 | 5.220 | 5.320 | 5.420 |
| E | 0.950 | 1.000 | 1.050 |
| E1 | 9.700 | 9.900 | 10.100 |
| E2 | 6.050 | 6.100 | 6.150 |
| e | 2.286BSC | | |
| e1 | 4.572REF. | | |
| L | 2.650 | 2.800 | 2.950 |
| L1 | 0.700 | 0.800 | 0.900 |
| θ 1 | 7° REF. | | |
| R | 1.300REF. | | |
| R1 | 0.250REF. | | |

Disclaimer:

The information provided in this document is believed to be accurate and reliable. however, Shenzhen Core Control Electronics Technology Co., Ltd. does not assume any responsibility for the following consequences. Do not consider the use of such information or use beyond its scope.

The information mentioned in this document may be changed at any time without notice.

The products and information provided in this document do not infringe patents. Shenzhen Core Control Electronics Technology Co., Ltd. assumes no responsibility for any infringement of any other rights of third parties. The result of using such products and information.

This document is the fourth version issued on March 10th, 2023. This document replaces all previously provided information.

 It is a registered trademark of Shenzhen Core Control Electronics Technology Co., Ltd.

Copyright © 2017 Shenzhen Core Control Electronics Technology Co., Ltd. all rights reserved.

X-ON Electronics

Largest Supplier of Electrical and Electronic Components

Click to view similar products for [MOSFET](#) category:

Click to view products by [AGM-Semi](#) manufacturer:

Other Similar products are found below :

[IRFD120](#) [JANTX2N5237](#) [BUK455-60A/B](#) [MIC4420CM-TR](#) [VN1206L](#) [NDP4060](#) [SI4482DY](#) [IPS70R2K0CEAKMA1](#) [SQD23N06-31L-GE3](#)
[TK16J60W,S1VQ\(O](#) [2SK2614\(TE16L1,Q\)](#) [DMN1017UCP3-7](#) [DMN1053UCP4-7](#) [SQJ469EP-T1-GE3](#) [NTE2384](#) [DMC2700UDMQ-7](#)
[DMN2080UCB4-7](#) [DMN61D9UWQ-13](#) [US6M2GTR](#) [DMN31D5UDJ-7](#) [DMP22D4UFO-7B](#) [DMN1006UCA6-7](#) [DMN16M9UCA6-7](#)
[STF5N65M6](#) [IRF40H233XTMA1](#) [STU5N65M6](#) [DMN6022SSD-13](#) [DMN13M9UCA6-7](#) [DMTH10H4M6SPS-13](#) [DMN2990UFB-7B](#)
[IPB80P04P405ATMA2](#) [2N7002W-G](#) [MCAC30N06Y-TP](#) [MCQ7328-TP](#) [BXP7N65D](#) [BXP4N65F](#) [AOL1454G](#) [WMJ80N60C4](#) [BXP2N20L](#)
[BXP2N65D](#) [BXT1150N10J](#) [BXT1700P06M](#) [TSM60NB380CP](#) [ROG](#) [RQ7L055BGTCR](#) [DMNH15H110SK3-13](#) [SLF10N65ABV2](#)
[BSO203SP](#) [BSO211P](#) [IPA60R230P6](#) [IPA60R460CE](#)