

● General Description

The AGM3415E combines advanced trench MOSFET technology with a low resistance package to provide extremely low $R_{DS(ON)}$.

This device is ideal for load switch and battery protection applications.

● Features

- Advance high cell density Trench technology
- Low $R_{DS(ON)}$ to minimize conductive loss
- Low Gate Charge for fast switching
- Low Thermal resistance

● Application

- MB/VGA Vcore
- SMPS 2nd Synchronous Rectifier
- POL application
- BLDC Motor driver

Product Summary

BVDSS	RDSON	ID
-20V	28mΩ	-5.0A

SOT-23-3 Pin Configuration

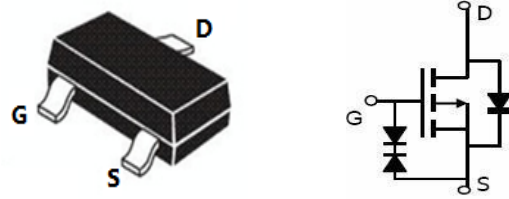

Package Marking and Ordering Information

Device Marking	Device	Device Package	Reel Size	Tape width	Quantity
3415E	AGM3415E	SOT-23-3	----	----	3000

Table 1. Absolute Maximum Ratings (TA=25°C)

Symbol	Parameter	Value	Unit
VDS	Drain-Source Voltage (VGS=0V)	-20	V
VGS	Gate-Source Voltage (VDS=0V)	±10	V
ID	Drain Current-Continuous(Ta=25°C) (Note 1)	-5.0	A
	Drain Current-Continuous(Ta=70°C)	-3.0	A
IDM (pluse)	Drain Current-Continuous@ Current-Pulsed (Note 2)	-18	A
PD	Maximum Power Dissipation(Ta=25°C)	1.32	w
TJ,TSTG	Operating Junction and Storage Temperature Range	-55 To 150	°C

Table 2. Thermal Characteristic

Symbol	Parameter	Typ	Max	Unit
RθJA	Thermal Resistance Junction-ambient (Steady State) ¹	---	95	°C/W

Table 3. Electrical Characteristics (TA=25°C unless otherwise noted)

Symbol	Parameter	Conditions	Min	Typ	Max	Unit
On/Off States						
BVDSS	Drain-Source Breakdown Voltage	VGS=0V ID=-250μA	-20	--	--	V
IDSS	Zero Gate Voltage Drain Current	VDS=-20V,VGS=0V	--	--	-1	μA
IGSS	Gate-Body Leakage Current	VGS=±10V,VDS=0V	--	--	±8	μA
VGS(th)	Gate Threshold Voltage	VDS=VGS,ID=-250μA	-0.4	-0.7	-1.0	V
gFS	Forward Transconductance	VDS=-10V,ID=-3A	--	6	--	S
RDS(on)	Drain-Source On-State Resistance	VGS=-4.5V, ID=-4A	--	28	35	mΩ
		VGS=-2.5V, ID=-3.0A	--	38	53	mΩ
Dynamic Characteristics						
Ciss	Input Capacitance	VDS=-10V,VGS=0V, VDS=0V,f=1.0MHz	--	830	--	pF
Coss	Output Capacitance		--	132	--	pF
Crss	Reverse Transfer Capacitance		--	85	--	Ω
Rg	Gate resistance					
Switching Times						
td(on)	Turn-on Delay Time	VGS=-10V, VDS=-4.5V, ID=-3.3A, RG=1Ω	--	10	--	nS
tr	Turn-on Rise Time		--	32	--	nS
td(off)	Turn-Off Delay Time		--	50	--	nS
tf	Turn-Off Fall Time		--	51	--	nC
Qg	Total Gate Charge	VGS=-10V, VDS=-4.5V, ID=-2.0A	--	8.8	--	nC
Qgs	Gate-Source Charge		--	1.4	--	nC
Qgd	Gate-Drain Charge		--	1.9	--	nC
Source-Drain Diode Characteristics						
ISD	Source-Drain Current(Body Diode)	VGS=0V,IS=-4A	--	--	-5.0	V
VSD	Forward on Voltage	IF=-4.1A , dI/dt=100A/μs , TJ=25°C	--	--	-1.2	V
trr	Reverse Recovery Time		--	--	--	ns
Qrr	Reverse Recovery Charge		--	--	--	nc

Notes 1.The maximum current rating is package limited.

Notes 2.Repetitive Rating: Pulse width limited by maximum junction temperature

Notes 3.EAS condition: TJ=25°C

Typical Performance Characteristics

Figure 1: Output Characteristics

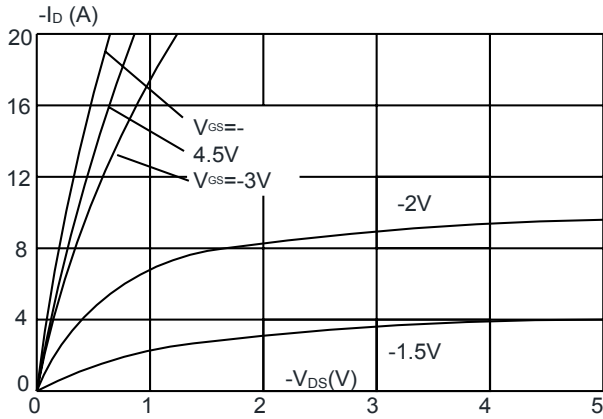

Figure 2: Typical Transfer Characteristics

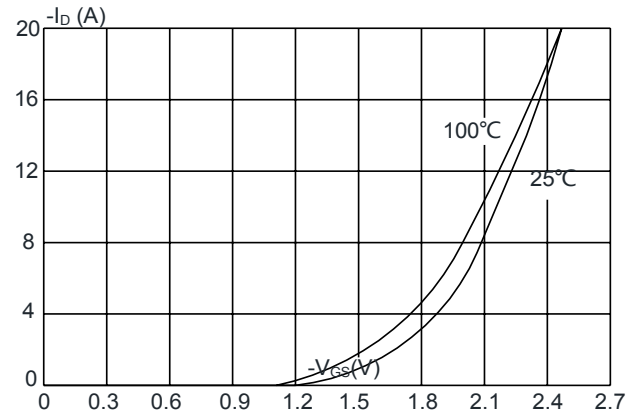

Figure 3: On-resistance vs. Drain Current

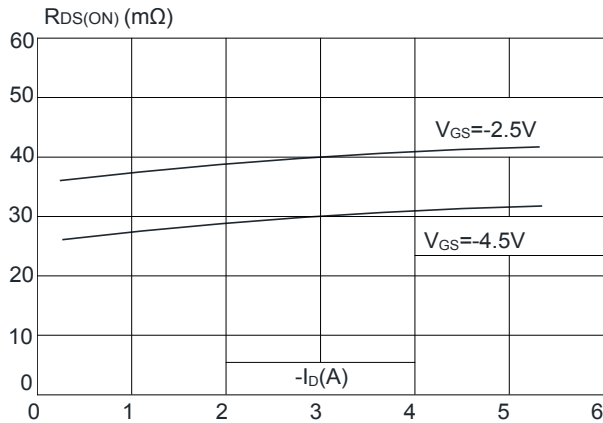

Figure 4: Body Diode Characteristics

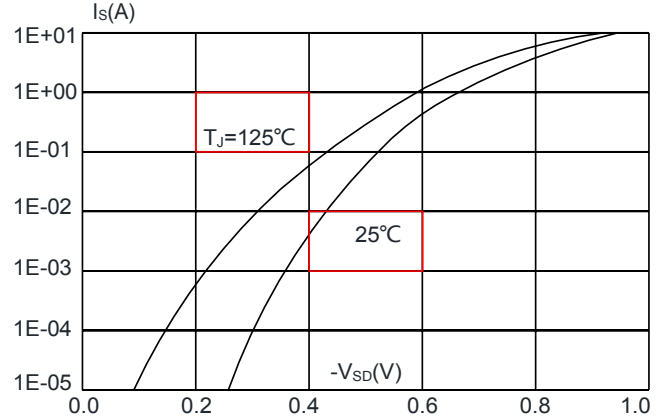

Figure 5: Gate Charge Characteristics

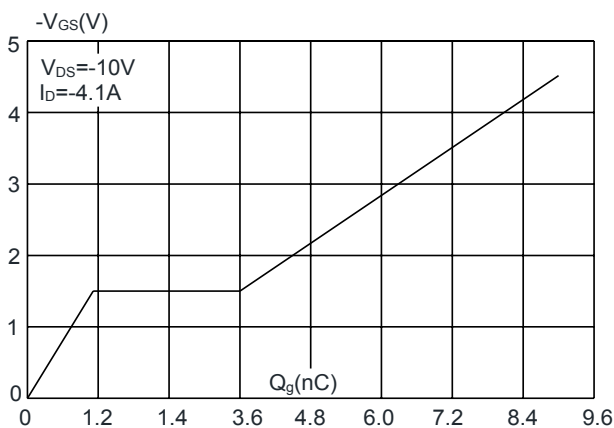

Figure 6: Capacitance Characteristics

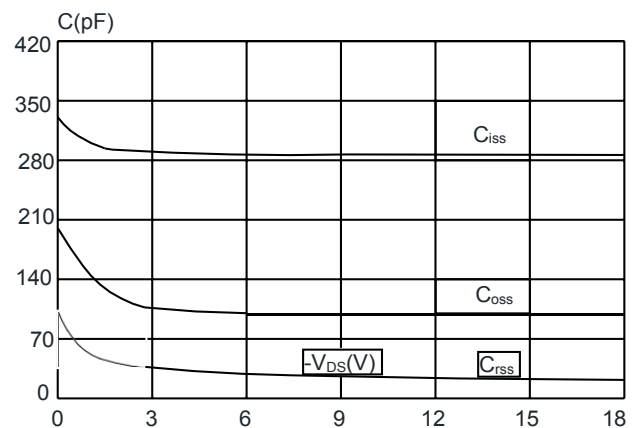
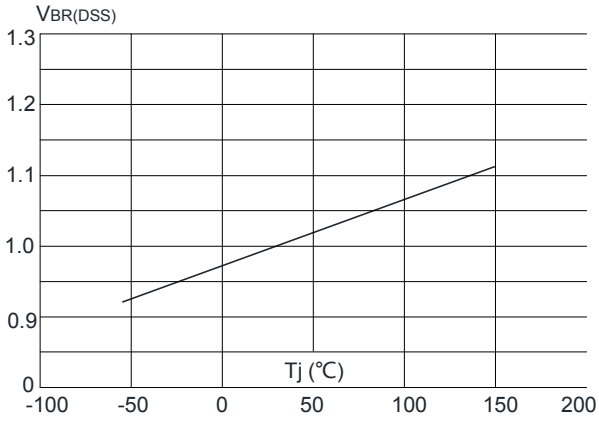
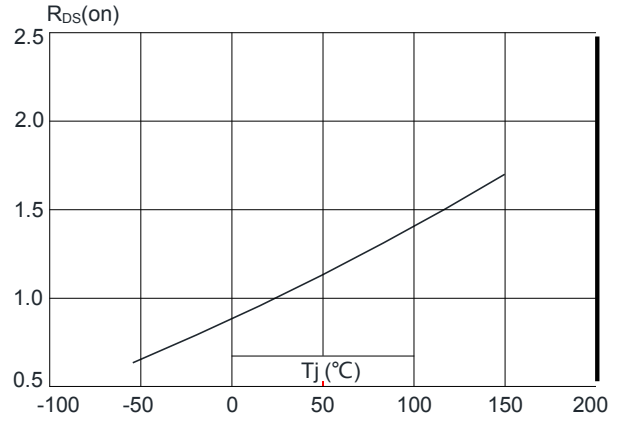
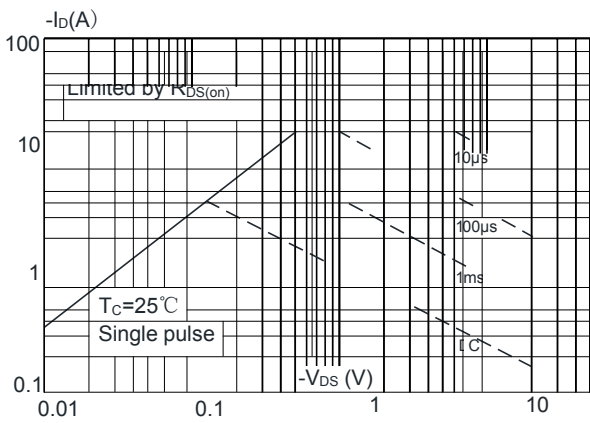
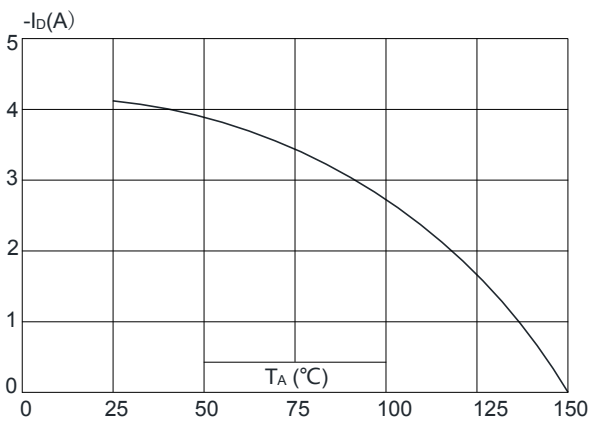
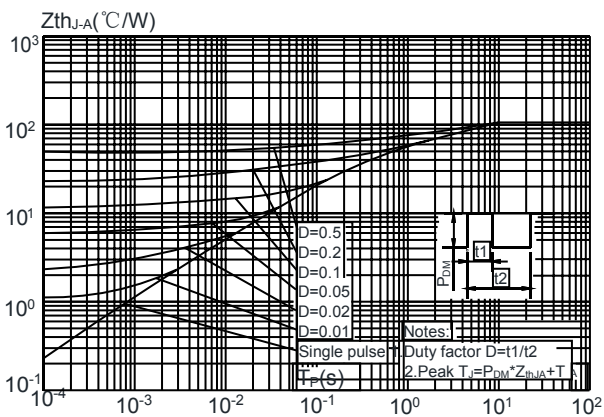
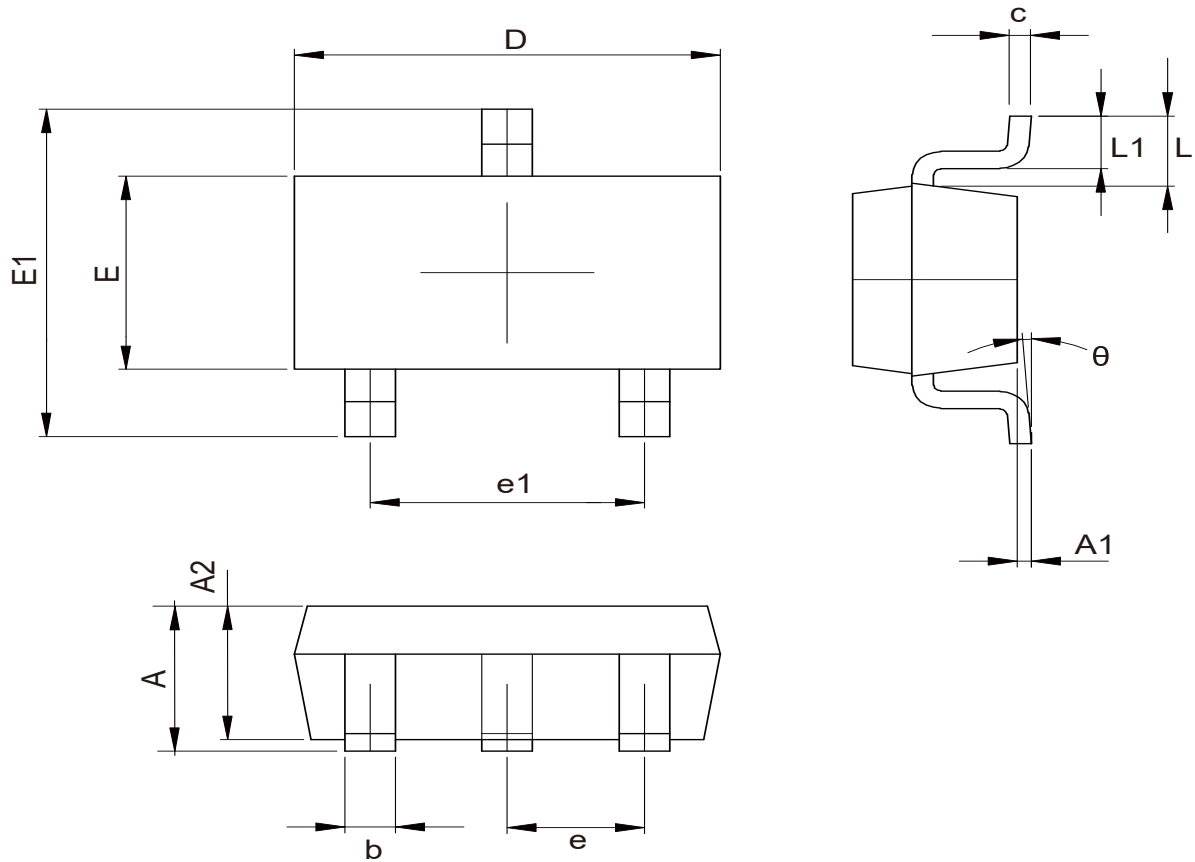

Figure 7: Normalized Breakdown Voltage vs. Junction Temperature

Figure 8: Normalized on Resistance vs. Junction Temperature

Figure 9: Maximum Safe Operating Area

Figure 10: Maximum Continuous Drain Current vs. Ambient Temperature

Figure.11: Maximum Effective Transient Thermal Impedance, Junction-to-Ambient

SOT-23-3L
PACKAGE OUTLINE DIMENSIONS



COMMON DIMENSIONS			
CUNITS MEASURE=MILLIMETER			
SYMBOL	MIN	NOM	MAX
A	1.050	---	1.300
A1	0.000	---	0.200
A2	1.050	---	1.200
b	0.300	0.400	0.500
c	0.100	---	0.200
D	2.820	2.900	3.020
E	1.500	1.600	1.700
E1	2.650	2.800	2.950
e	0.950TYP		
e1	1.800	1.900	2.000
L	0.6REF		
L1	0.300	0.450	0.600
θ	0°	--	8°

Unit:mm

Disclaimer:

The information provided in this document is believed to be accurate and reliable. however, Shenzhen Core Control Electronics Technology Co., Ltd. does not assume any responsibility for the following consequences. Do not consider the use of such information or use beyond its scope.

The information mentioned in this document may be changed at any time without notice.

The products and information provided in this document do not infringe patents. Shenzhen Core Control Electronics Technology Co., Ltd. assumes no responsibility for any infringement of any other rights of third parties. The result of using such products and information.

This document is the second version issued on October 15, 2022. This document replaces and Replace all previously provided information.

 It is a registered trademark of Shenzhen Core Control Electronics Technology Co., Ltd.

Copyright © 2017 Shenzhen Core Control Electronics Technology Co., Ltd. all rights reserved.

X-ON Electronics

Largest Supplier of Electrical and Electronic Components

Click to view similar products for [MOSFET](#) category:

Click to view products by [AGM-Semi](#) manufacturer:

Other Similar products are found below :

[IRFD120](#) [JANTX2N5237](#) [BUK455-60A/B](#) [MIC4420CM-TR](#) [VN1206L](#) [NDP4060](#) [SI4482DY](#) [IPS70R2K0CEAKMA1](#) [SQD23N06-31L-GE3](#)
[TK16J60W,S1VQ\(O](#) [2SK2614\(TE16L1,Q\)](#) [DMN1017UCP3-7](#) [DMN1053UCP4-7](#) [SQJ469EP-T1-GE3](#) [NTE2384](#) [DMC2700UDMQ-7](#)
[DMN2080UCB4-7](#) [DMN61D9UWQ-13](#) [US6M2GTR](#) [DMN31D5UDJ-7](#) [DMP22D4UFO-7B](#) [DMN1006UCA6-7](#) [DMN16M9UCA6-7](#)
[STF5N65M6](#) [IRF40H233XTMA1](#) [STU5N65M6](#) [DMN6022SSD-13](#) [DMN13M9UCA6-7](#) [DMTH10H4M6SPS-13](#) [DMN2990UFB-7B](#)
[IPB80P04P405ATMA2](#) [2N7002W-G](#) [MCAC30N06Y-TP](#) [MCQ7328-TP](#) [NTMC083NP10M5L](#) [BXP7N65D](#) [BXP4N65F](#) [AOL1454G](#)
[WMJ80N60C4](#) [BXP2N20L](#) [BXP2N65D](#) [BXT1150N10J](#) [BXT1700P06M](#) [TSM60NB380CP](#) [ROG](#) [RQ7L055BGTGR](#) [DMNH15H110SK3-13](#)
[SLF10N65ABV2](#) [BSO203SP](#) [BSO211P](#) [IPA60R230P6](#)