

### • General Description

The AGM425ME combines advanced trench MOSFET technology with a low resistance package to provide extremely low  $R_{DS(ON)}$

This device is ideal for load switch and battery protection applications.

### • Features

- Advance high cell density Trench technology
- Low  $R_{DS(ON)}$  to minimize conductive loss
- Low Gate Charge for fast switching
- Low Thermal resistance
- 100% Avalanche tested
- 100% DVDS tested

### • Application

- MB/VGA Vcore
- SMPS 2<sup>nd</sup> Synchronous Rectifier
- POL application
- BLDC Motor driver

### Product Summary

BVDSS	RDSON	ID
40V	25mΩ	6.6A
-40V	65.5mΩ	-3.3A

### SOT23-6L Pin Configuration

### Package Marking and Ordering Information

Device Marking	Device	Device Package	Reel Size	Tape width	Quantity
AGM425ME	AGM425ME	SOT23-6L	178mm	8mm	3000

**Table 1. Absolute Maximum Ratings (TA=25°C)**

Symbol	Parameter	Rating		Units
		N-Ch	P-Ch	
$V_{DS}$	Drain-Source Voltage ( $V_{GS}=0V$ )	40	-40	V
$V_{GS}$	Gate-Source Voltage ( $V_{DS}=0V$ )	±20	±20	V
$I_D$	Drain Current-Continuous(TA=25°C) <b>(Note 1)</b>	6.6	-3.3	A
	Drain Current-Continuous(TA=100°C)	5.2	-2.2	A
IDM (pluse)	Drain Current-Pulsed <b>(Note 2)</b>	26.4	-13.2	A
$P_D$	Total Power Dissipation(TA=25°C)	1.25	1.25	W
	Total Power Dissipation(TA=100°C)	0.5	0.5	W
EAS	Avalanche energy <b>(Note 3)</b>	13	15	mJ
TJ,TSTG	Operating Junction and Storage Temperature Range	-55 To 150	-55 To 150	°C

**Table 2. Thermal Characteristic**

Symbol	Parameter	Typ	Max	Unit
$R_{\theta JA}$	Thermal Resistance Junction-ambient (Steady State) <sup>1</sup>	---	100	°C/W

**Table 3. N- Channel Electrical Characteristics (T<sub>J</sub>=25°C unless otherwise noted)**

Symbol	Parameter	Conditions	Min	Typ	Max	Unit
<b>On/Off States</b>						
BVDSS	Drain-Source Breakdown Voltage	VGS=0V ID=250μA	40	--	--	V
IDSS	Zero Gate Voltage Drain Current	VDS=40V,VGS=0V	--	--	1	μA
IGSS	Gate-Body Leakage Current	VGS=±20V,VDS=0V	--	--	±100	nA
VGS(th)	Gate Threshold Voltage	VDS=VGS,ID=250μA	1.2	1.5	2.2	V
gFS	Forward Transconductance	VDS=5V,ID=3A	--	8	--	S
RDS(on)	Drain-Source On-State Resistance	VGS=10V, ID=4A	--	25	33	mΩ
		VGS=4.5V, ID=3A	--	34.5	55	mΩ
<b>Dynamic Characteristics</b>						
Ciss	Input Capacitance	VDS=20V,VGS=0V, F=1MHZ	--	495	--	pF
Coss	Output Capacitance		--	42	--	pF
Crss	Reverse Transfer Capacitance		--	33	--	pF
Rg	Gate resistance	VGS=0V, VDS=0V,f=1.0MHz	--	--	--	Ω
<b>Switching Times</b>						
td(on)	Turn-on Delay Time	VGS=10V,VDS=20V, ID=3.5A,RGEN=3Ω	--	15	--	nS
tr	Turn-on Rise Time		--	49.5	--	nS
td(off)	Turn-Off Delay Time		--	19.2	--	nS
tf	Turn-Off Fall Time		--	11	--	nS
Qg	Total Gate Charge	VGS=10V, VDS=20V, ID=3.5A	--	10	--	nC
Qgs	Gate-Source Charge		--	1.4	--	nC
Qgd	Gate-Drain Charge		--	1.9	--	nC
<b>Source-Drain Diode Characteristics</b>						
ISD	Source-Drain Current(Body Diode)		--	--	6.6	A
VSD	Forward on Voltage	VGS=0V,IS=4A	--	--	1.2	V
trr	Reverse Recovery Time	IF=4A , dI/dt=100A/μs ,	--	2.6	--	ns
Qrr	Reverse Recovery Charge	TJ=25°C	--	19	--	nc

Notes 1.The maximum current rating is package limited.

Notes 2.Repetitive Rating: Pulse width limited by maximum junction temperature

Notes 3.EAS condition: T<sub>J</sub>=25°C ,VDD=25V,Vgs=10V,ID=7.2A, L=0.5mH,RG=25ohm

**Table 3. P-Channel Electrical Characteristics (T<sub>J</sub>=25°C unless otherwise noted)**

Symbol	Parameter	Conditions	Min	Typ	Max	Unit
<b>On/Off States</b>						
BVDSS	Drain-Source Breakdown Voltage	VGS=0V ID=-250μA	-40	--	--	V
IDSS	Zero Gate Voltage Drain Current	VDS=-40V, VGS=0V	--	--	-1	μA
IGSS	Gate-Body Leakage Current	VGS=±20V, VDS=0V	--	--	±100	nA
VGS(th)	Gate Threshold Voltage	VDS=VGS, ID=-250μA	-1.2	-1.5	-2.2	V
gFS	Forward Transconductance	VDS=-5V, ID=-3A	--	4	--	S
RDS(on)	Drain-Source On-State Resistance	VGS=-10V, ID=-4A	--	65.5	79	mΩ
		VGS=-4.5V, ID=-3A	--	78	94	mΩ
<b>Dynamic Characteristics</b>						
Ciss	Input Capacitance	VDS=-20V, VGS=0V, F=1MHZ	--	600	--	pF
Coss	Output Capacitance		--	90	--	pF
Crss	Reverse Transfer Capacitance		--	70	--	pF
Rg	Gate resistance	VGS=0V, VDS=0V, f=1.0MHz	--	--	--	Ω
<b>Switching Times</b>						
td(on)	Turn-on Delay Time	VGS=-10V, VDS=-20V, ID=-3A, RGEN=3Ω	--	9	--	nS
tr	Turn-on Rise Time		--	8	--	nS
td(off)	Turn-Off Delay Time		--	28	--	nS
tf	Turn-Off Fall Time		--	10	--	nS
Qg	Total Gate Charge	VGS=-10V, VDS=-20V, ID=-3A	--	14	--	nC
Qgs	Gate-Source Charge		--	2.9	--	nC
Qgd	Gate-Drain Charge		--	3.8	--	nC
<b>Source-Drain Diode Characteristics</b>						
ISD	Source-Drain Current(Body Diode)		--	--	-3.3	A
VSD	Forward on Voltage	VGS=0V, IS=-4A	--	--	-1.2	V
trr	Reverse Recovery Time	IF=-4A , di/dt=100A/μs , TJ=25°C	--	--	--	ns
Qrr	Reverse Recovery Charge		--	--	--	nc

Notes 1. The maximum current rating is package limited.

Notes 2. Repetitive Rating: Pulse width limited by maximum junction temperature

Notes 3. EAS condition: T<sub>J</sub>=25°C, VDD=25V, Vgs=10V, ID=7.8A, L=0.5mH, RG=25ohm

## N-Channel Typical Characteristics

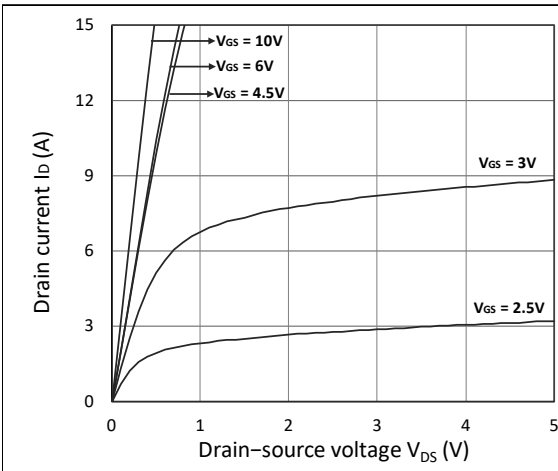

Figure 1. Output Characteristics

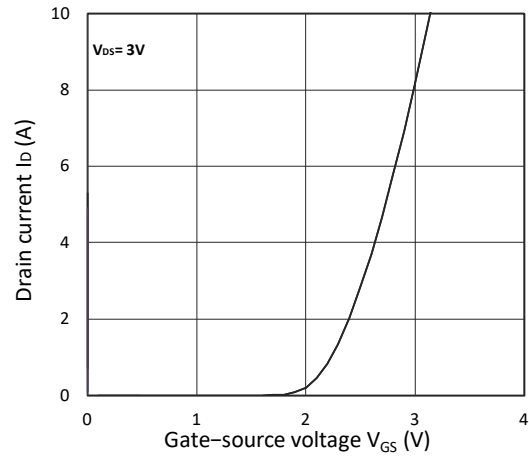

Figure 2. Transfer Characteristics

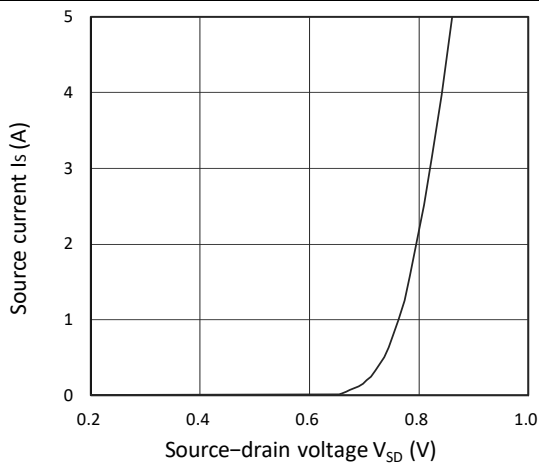
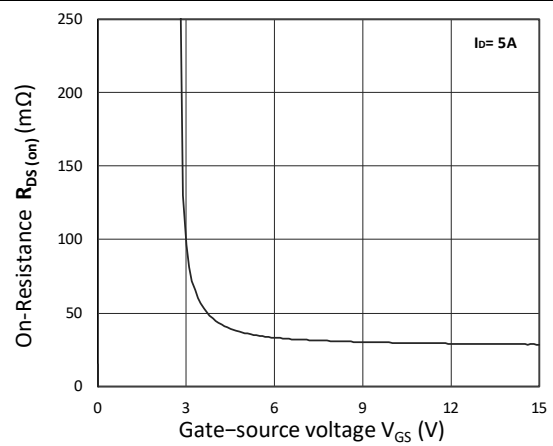
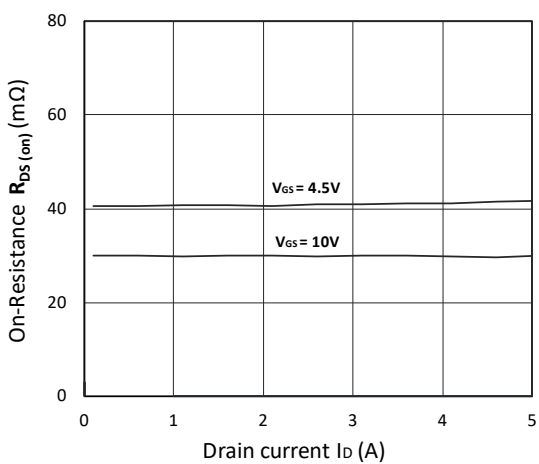
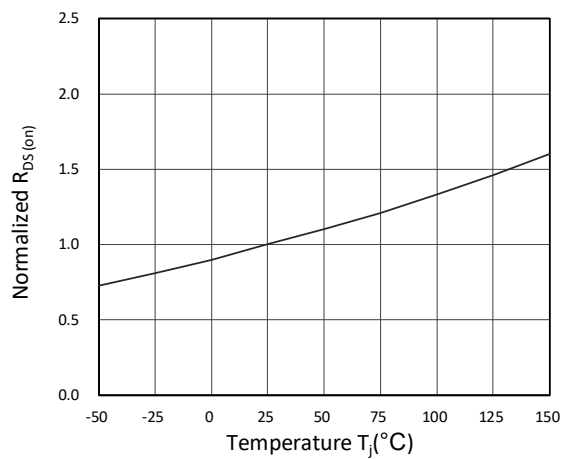
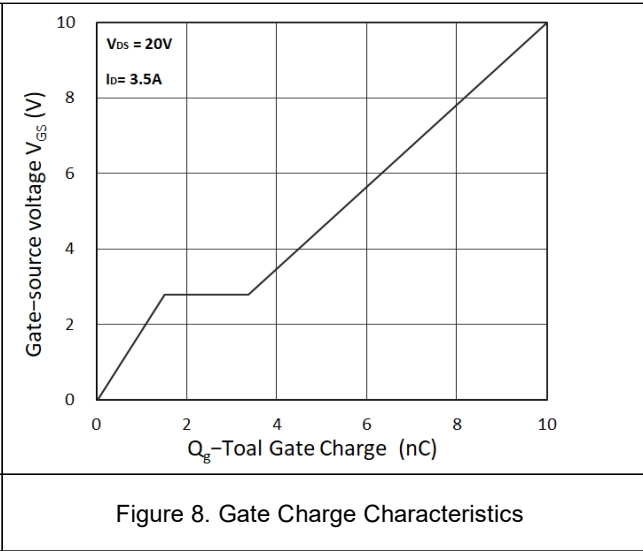
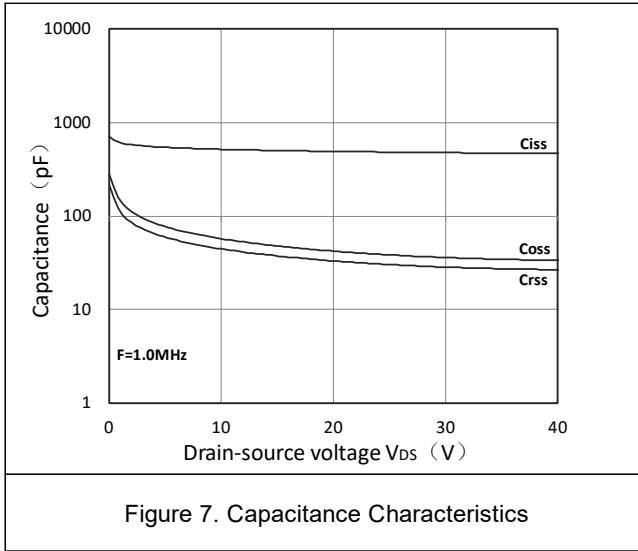

Figure 3. Forward Characteristics of Reverse

 Figure 4.  $R_{DS(ON)}$  vs.  $V_{GS}$ 

 Figure 5.  $R_{DS(ON)}$  vs.  $I_D$ 

 Figure 6. Normalized  $R_{DS(on)}$  vs. Temperature



## P-Channel Typical Characteristics

### Typical Electrical and Thermal Characteristics

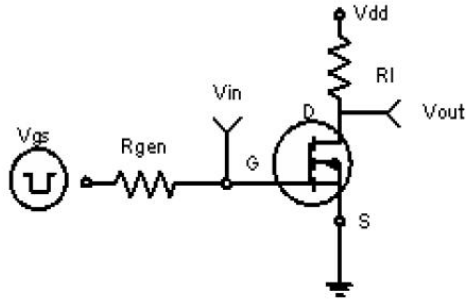

Figure 1: Switching Test Circuit

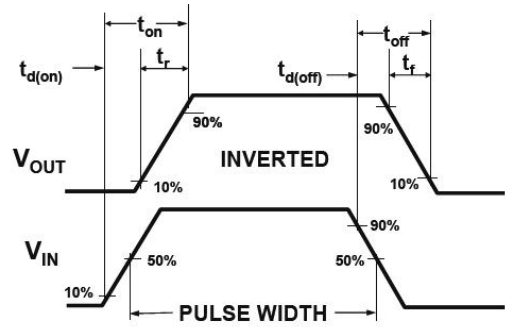

Figure 2: Switching Waveforms

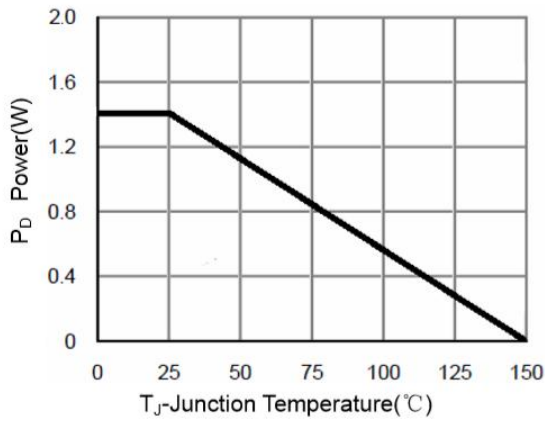

Figure 3 Power Dissipation

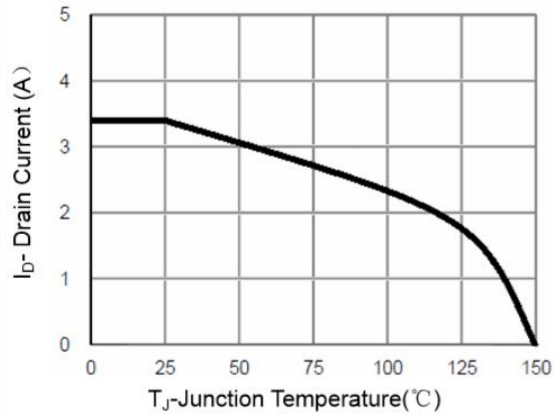

Figure 4 Drain Current

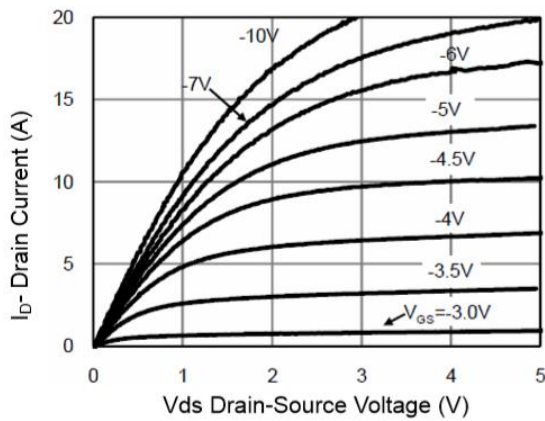

Figure 5 Output Characteristics

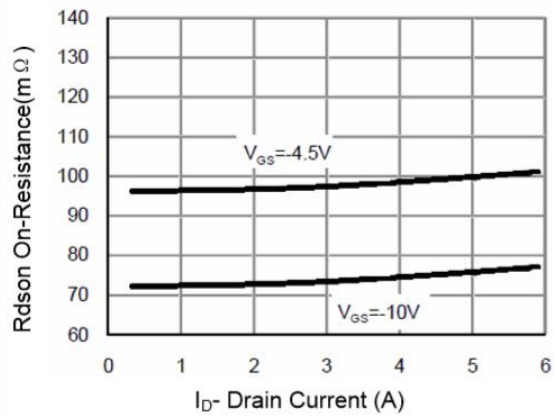

Figure 6 Drain-Source On-Resistance

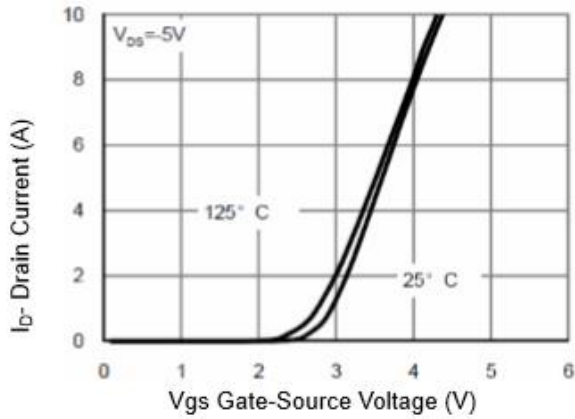

Figure 7 Transfer Characteristics

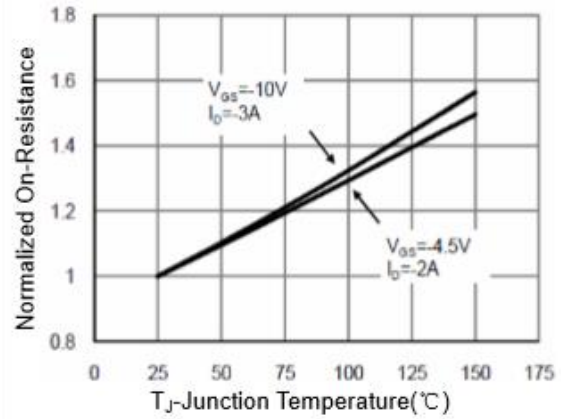

Figure 8 Drain-Source On-Resistance

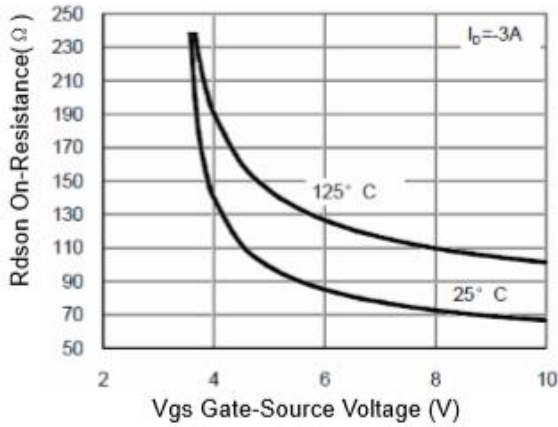

Figure 9 Rdson vs Vgs

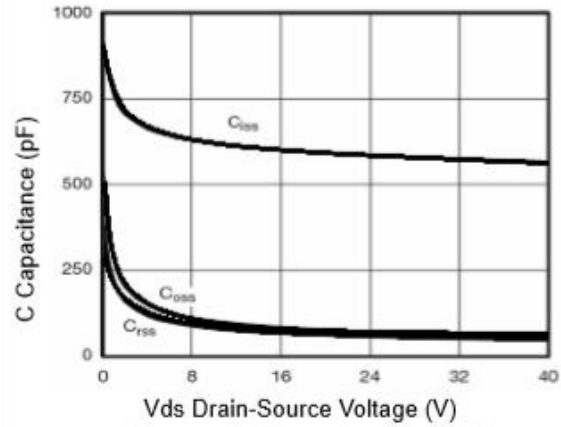

Figure 10 Capacitance vs Vds

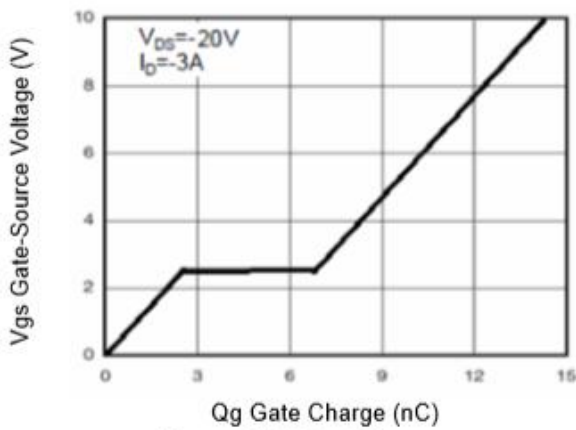

Figure 11 Gate Charge

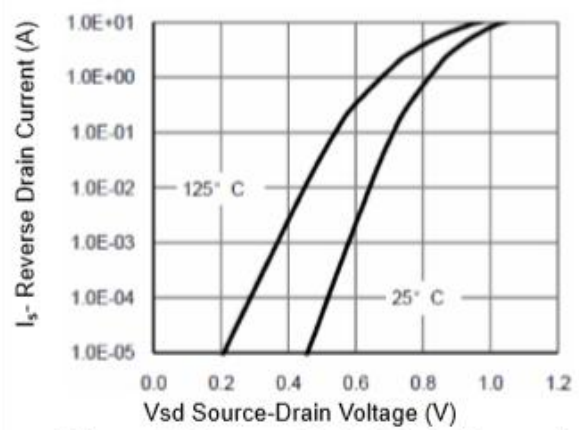

Figure 12 Source- Drain Diode Forward

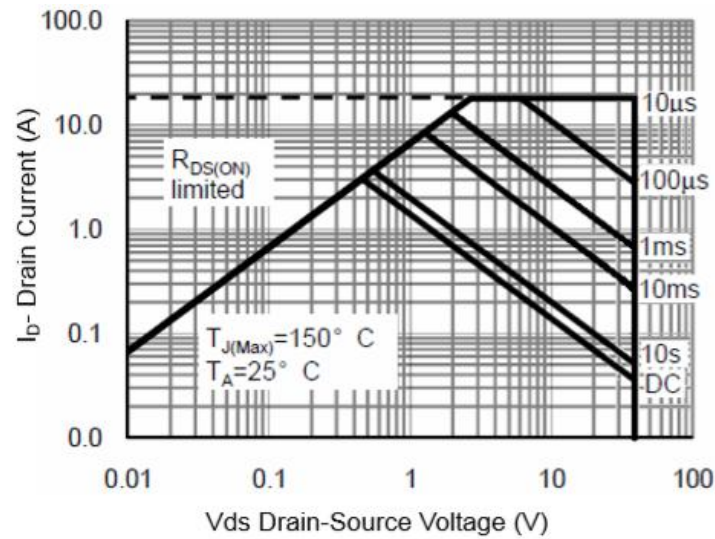

Figure 13 Safe Operation Area

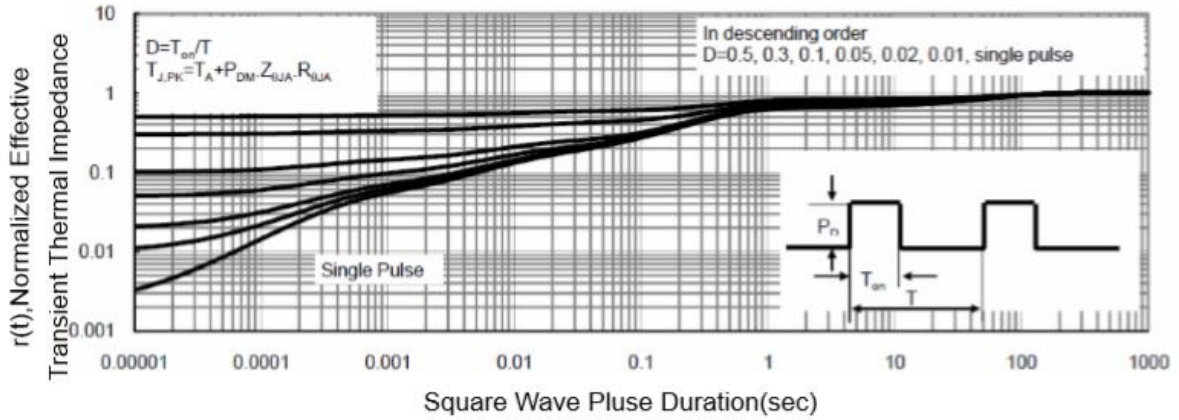
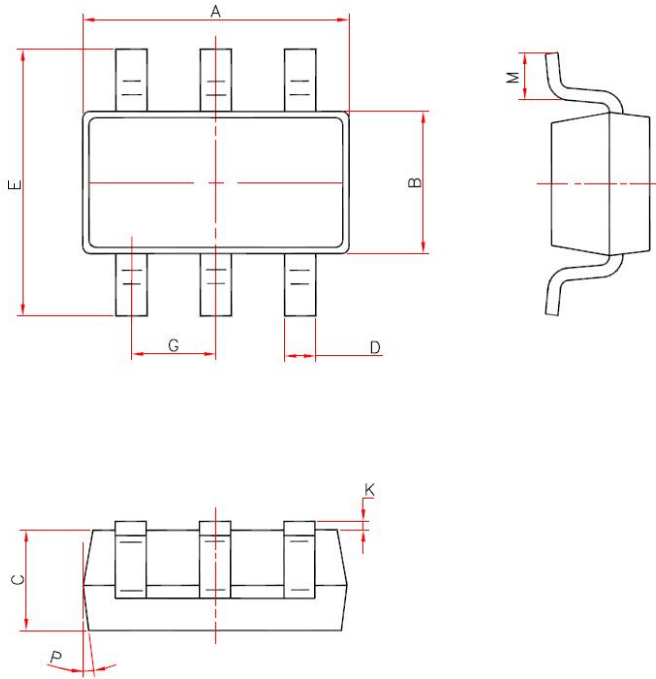

Figure 14 Normalized Maximum Transient Thermal Impedance



### Package Outline Data SOT-23-6



DIM	MILLIMETERS
A	2.82~3.02
B	1.60 ± 0.10
C	1.10 ± 0.05
D	0.40 ± 0.10
E	2.65~2.95
G	0.95typ
K	0.00~0.10
M	0.20MIN
P	9 ± 2°

Disclaimer:

The information provided in this document is believed to be accurate and reliable. however, Shenzhen Core Control Electronics Technology Co., Ltd. does not assume any responsibility for the following consequences. Do not consider the use of such information or use beyond its scope.

The information mentioned in this document may be changed at any time without notice.

The products and information provided in this document do not infringe patents. Shenzhen Core Control Electronics Technology Co., Ltd. assumes no responsibility for any infringement of any other rights of third parties. The result of using such products and information.

This document is the second version issued on Dec. 10th, 2023. This document replaces all previously provided information.

 It is a registered trademark of Shenzhen Core Control Electronics Technology Co., Ltd.

Copyright © 2017 Shenzhen Core Control Electronics Technology Co., Ltd. all rights reserved.

## X-ON Electronics

Largest Supplier of Electrical and Electronic Components

*Click to view similar products for [MOSFET](#) category:*

*Click to view products by [AGM-Semi](#) manufacturer:*

Other Similar products are found below :

[IRFD120](#) [JANTX2N5237](#) [BUK455-60A/B](#) [MIC4420CM-TR](#) [VN1206L](#) [NDP4060](#) [SI4482DY](#) [IPS70R2K0CEAKMA1](#) [SQD23N06-31L-GE3](#)  
[TK16J60W,S1VQ\(O](#) [2SK2614\(TE16L1,Q\)](#) [DMN1017UCP3-7](#) [DMN1053UCP4-7](#) [SQJ469EP-T1-GE3](#) [NTE2384](#) [DMC2700UDMQ-7](#)  
[DMN2080UCB4-7](#) [DMN61D9UWQ-13](#) [US6M2GTR](#) [DMN31D5UDJ-7](#) [DMP22D4UFO-7B](#) [DMN1006UCA6-7](#) [DMN16M9UCA6-7](#)  
[STF5N65M6](#) [IRF40H233XTMA1](#) [STU5N65M6](#) [DMN6022SSD-13](#) [DMN13M9UCA6-7](#) [DMTH10H4M6SPS-13](#) [DMN2990UFB-7B](#)  
[IPB80P04P405ATMA2](#) [2N7002W-G](#) [MCAC30N06Y-TP](#) [MCQ7328-TP](#) [NTMC083NP10M5L](#) [BXP7N65D](#) [BXP4N65F](#) [AOL1454G](#)  
[WMJ80N60C4](#) [BXP2N20L](#) [BXP2N65D](#) [BXT1150N10J](#) [BXT1700P06M](#) [TSM60NB380CP](#) [ROG](#) [RQ7L055BGTGR](#) [DMNH15H110SK3-13](#)  
[SLF10N65ABV2](#) [BSO203SP](#) [BSO211P](#) [IPA60R230P6](#)