

General Description

The AGM6035F combines advanced trench MOSFET technology with a low resistance package to provide extremely low $R_{DS(ON)}$.

This device is ideal for load switch and battery protection applications.

Features

- Advance high cell density Trench technology
- Low $R_{DS(ON)}$ to minimize conductive loss
- Low Gate Charge for fast switching
- Low Thermal resistance
- 100% Avalanche tested
- 100% DVDS tested

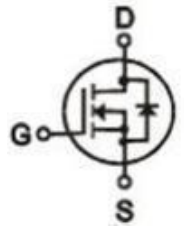
Application

- MB/VGA Vcore
- SMPS 2nd Synchronous Rectifier
- POL application
- BLDC Motor driver

Product Summary

BVDSS	RDSON	ID
60V	2.4mΩ	130A

TO-220F Pin Configuration



Package Marking and Ordering Information

Device Marking	Device	Device Package	Reel Size	Tape width	Quantity
AGM6035F	AGM6035F	TO-220F	----	----	1000

Table 1. Absolute Maximum Ratings (TA=25°C)

Symbol	Parameter	Value	Unit
VDS	Drain-Source Voltage (VGS=0V)	60	V
VGS	Gate-Source Voltage (VDS=0V)	±20	V
ID	Drain Current-Continuous(Tc=25°C) (Note 1)	130	A
	Drain Current-Continuous(Tc=100°C)	80	A
IDM (pulse)	Drain Current-Continuous@ Current-Pulsed (Note 2)	520	A
PD	Maximum Power Dissipation(Tc=25°C)	208	w
	Maximum Power Dissipation(Tc=100°C)	83	w
EAS	Avalanche energy (Note 3)	200	mJ
TJ,TSTG	Operating Junction and Storage Temperature Range	-55 To 150	°C

Table 2. Thermal Characteristic

Symbol	Parameter	Typ	Max	Unit
RθJA	Thermal Resistance Junction-ambient (Steady State) ¹	---	60	°C/W
RθJC	Thermal Resistance Junction-Case ¹	---	0.6	°C/W

Table 3. Electrical Characteristics (T_J=25°C unless otherwise noted)

Symbol	Parameter	Conditions	Min	Typ	Max	Unit
On/Off States						
BVDSS	Drain-Source Breakdown Voltage	VGS=0V ID=250μA	60	--	--	V
IDSS	Zero Gate Voltage Drain Current	VDS=60V,VGS=0V	--	--	1	μA
IGSS	Gate-Body Leakage Current	VGS=±20V,VDS=0V	--	--	±100	nA
VGS(th)	Gate Threshold Voltage	VDS=VGS,ID=250μA	1.2	1.6	2.1	V
gFS	Forward Transconductance	VDS=5V,ID=10A	--	65	--	S
RDS(on)	Drain-Source On-State Resistance	VGS=10V, ID=20A	--	2.4	3.2	mΩ
		VGS=4.5V, ID=10A	--	3.3	4.2	mΩ
Dynamic Characteristics						
Ciss	Input Capacitance	VDS=30V,VGS=0V, F=100MHZ	--	3590	--	pF
Coss	Output Capacitance		--	1080	--	pF
Crss	Reverse Transfer Capacitance		--	60	--	pF
Rg	Gate resistance	VGS=0V, VDS=0V,f=1.0MHz	--	1.3	--	Ω
Switching Times						
td(on)	Turn-on Delay Time	VGS=10V,VDS=30V, ID=20A, RGEN=10Ω	--	14	--	nS
tr	Turn-on Rise Time		--	9.0	--	nS
td(off)	Turn-Off Delay Time		--	51	--	nS
tf	Turn-Off Fall Time		--	13	--	nS
Qg	Total Gate Charge	VGS=10V, VDS=30V, ID=20A	--	68	--	nC
Qgs	Gate-Source Charge		--	11	--	nC
Qgd	Gate-Drain Charge		--	20	--	nC
Source-Drain Diode Characteristics						
ISD	Source-Drain Current(Body Diode)		--	--	130	A
VSD	Forward on Voltage	VGS=0V,IS=20A	--	--	1.2	V
trr	Reverse Recovery Time	IS=20A , dI/dt=100A/μs , TJ=25°C	--	24	--	ns
Qrr	Reverse Recovery Charge		--	84	--	nc

Notes 1.The maximum current rating is package limited.

Notes 2.Repetitive Rating: Pulse width limited by maximum junction temperature

Notes 3.EAS condition: T_J=25°C

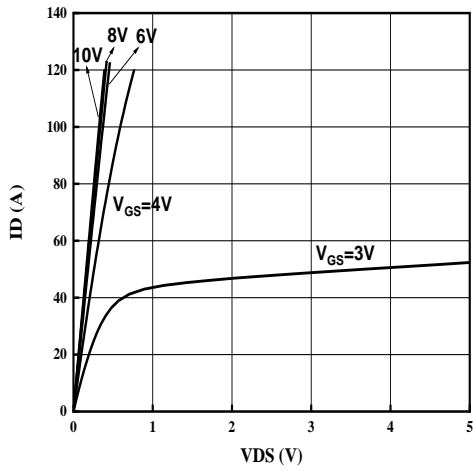
TYPICAL ELECTRICAL AND THERMAL CHARACTERISTICS


Fig1. Typical Output Characteristics

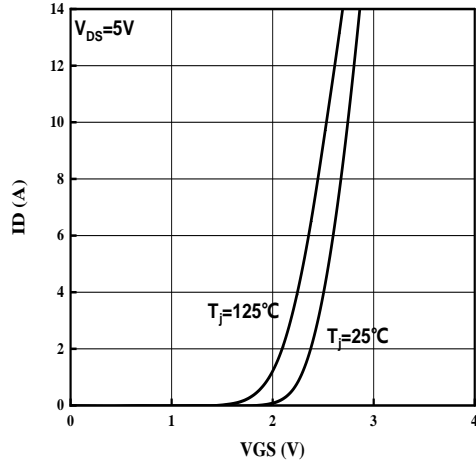


Fig2. Typical Transfer Characteristics

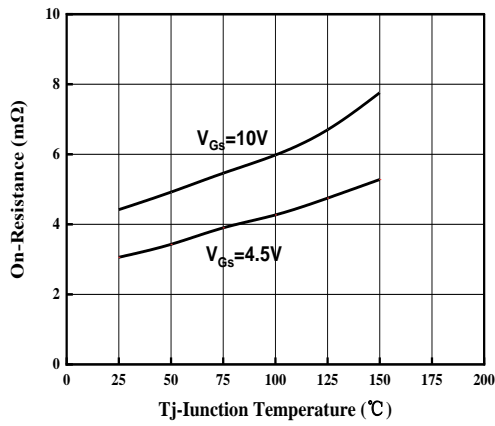


Fig3. On-Resistance Vs. Temperature

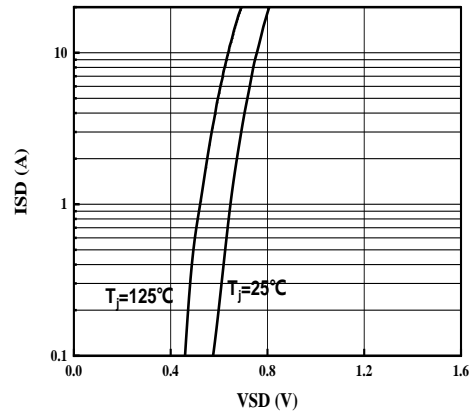


Fig4. Typical Source-Drain Diode Forward Voltage

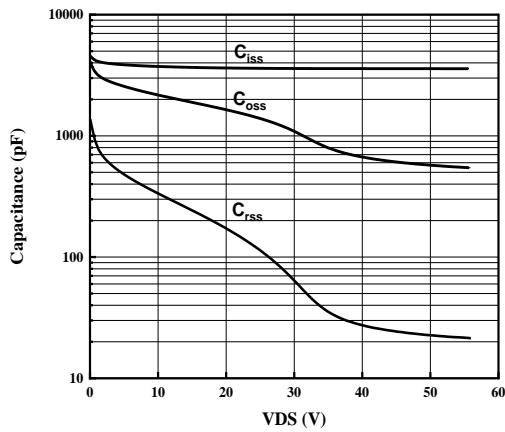


Fig5. Typical Capacitance

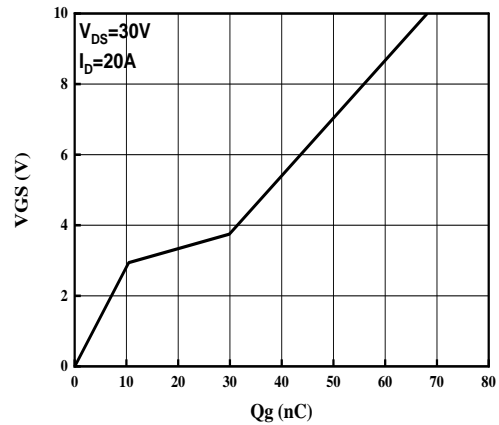


Fig6. Typical Gate Charge

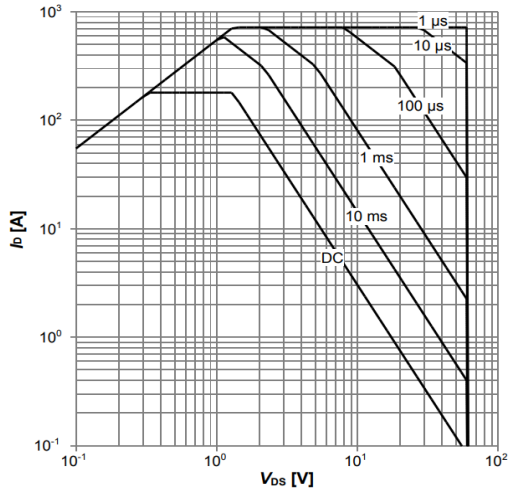


Fig7. Safe Operating Area

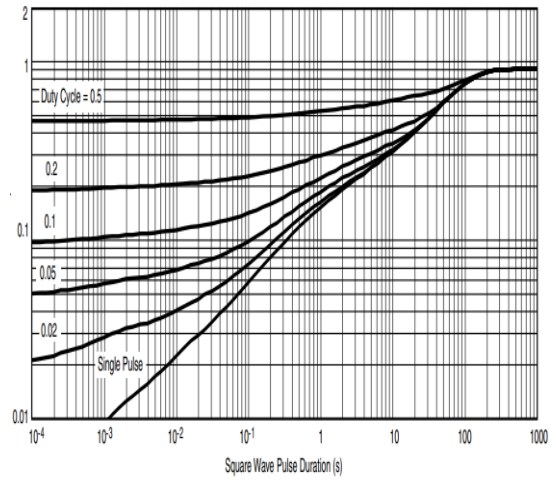
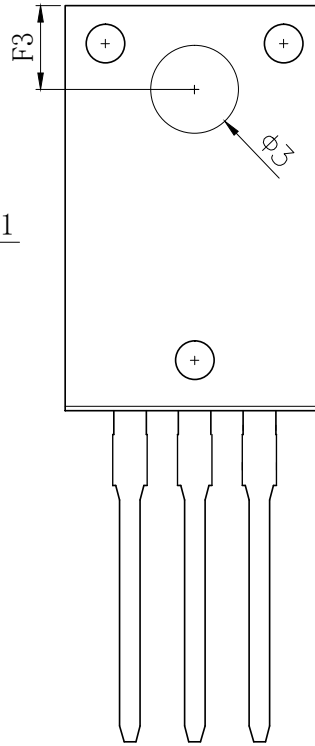
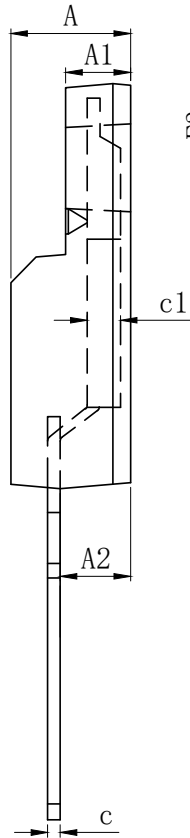
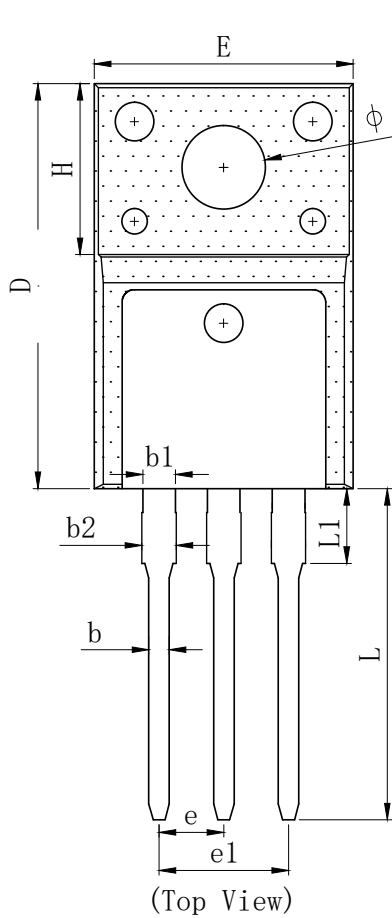


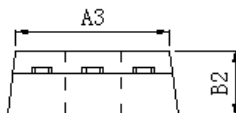
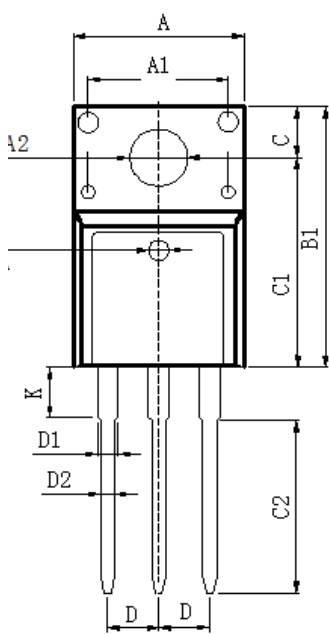
Fig8. Normalized transient thermal impedance

TO-220F Package Mechanical Data



(Bottom View)

SYMBOL	MILLIMETER		
	MIN	Typ.	MAX
A	4.500	4.700	4.900
A1	2.340	2.540	2.740
A2	2.560	2.760	2.960
b	0.700	0.800	0.950
b1	1.180	1.280	1.430
b2	1.250	1.350	1.550
c	0.400	0.500	0.650
c1	1.200	1.300	1.350
D	15.570	15.870	16.170
H	6.700 REF		
E	9.960	10.160	10.360
e	2.540 BSC		
e1	5.080 BSC		
L	12.680	12.980	13.280
L1	2.780	2.930	3.080
F3	3.150	3.300	3.450
φ	3.030	3.180	3.450
φ3	3.150	3.450	3.650



DIM	MILLIMETERS
A	10.16 ± 0.3
A1	7.00 ± 0.1
A2	3.3 ± 0.2
A3	9.5 ± 0.2
B1	15.87 ± 0.3
B2	4.7 ± 0.2
B3	6.68 ± 0.4
C	3.3 ± 0.2
C1	12.57 ± 0.3
C2	10.02 ± 0.5
D	2.54 ± 0.05
D1	1.28 ± 0.2
D2	0.8 ± 0.1
K	3.1 ± 0.3
E1	2.54 ± 0.1
E3	0.5 ± 0.1
E4	2.76 ± 0.2
DIA	⊙1.5 (deep 0.2)

Unit : mm


Disclaimer:

The information provided in this document is believed to be accurate and reliable. however, Shenzhen Core Control Electronics Technology Co., Ltd. does not assume any responsibility for the following consequences. Do not consider the use of such information or use beyond its scope.

The information mentioned in this document may be changed at any time without notice.

The products and information provided in this document do not infringe patents. Shenzhen Core Control Electronics Technology Co., Ltd. assumes no responsibility for any infringement of any other rights of third parties. The result of using such products and information.

This document is the first version issued on July 20th, 2023. This document replaces all previously provided information.

 It is a registered trademark of Shenzhen Core Control Electronics Technology Co., Ltd.

Copyright © 2017 Shenzhen Core Control Electronics Technology Co., Ltd. all rights reserved.

X-ON Electronics

Largest Supplier of Electrical and Electronic Components

Click to view similar products for [MOSFET](#) category:

Click to view products by [AGM-Semi](#) manufacturer:

Other Similar products are found below :

[IRFD120](#) [JANTX2N5237](#) [BUK455-60A/B](#) [MIC4420CM-TR](#) [VN1206L](#) [NDP4060](#) [SI4482DY](#) [IPS70R2K0CEAKMA1](#) [SQD23N06-31L-GE3](#)
[TK16J60W,S1VQ\(O](#) [2SK2614\(TE16L1,Q\)](#) [DMN1017UCP3-7](#) [DMN1053UCP4-7](#) [SQJ469EP-T1-GE3](#) [NTE2384](#) [DMC2700UDMQ-7](#)
[DMN2080UCB4-7](#) [DMN61D9UWQ-13](#) [US6M2GTR](#) [DMN31D5UDJ-7](#) [DMP22D4UFO-7B](#) [DMN1006UCA6-7](#) [DMN16M9UCA6-7](#)
[STF5N65M6](#) [IRF40H233XTMA1](#) [STU5N65M6](#) [DMN6022SSD-13](#) [DMN13M9UCA6-7](#) [DMTH10H4M6SPS-13](#) [DMN2990UFB-7B](#)
[IPB80P04P405ATMA2](#) [2N7002W-G](#) [MCAC30N06Y-TP](#) [MCQ7328-TP](#) [BXP7N65D](#) [BXP4N65F](#) [AOL1454G](#) [WMJ80N60C4](#) [BXP2N20L](#)
[BXP2N65D](#) [BXT1150N10J](#) [BXT1700P06M](#) [TSM60NB380CP](#) [ROG](#) [RQ7L055BGTCR](#) [DMNH15H110SK3-13](#) [SLF10N65ABV2](#)
[BSO203SP](#) [BSO211P](#) [IPA60R230P6](#) [IPA60R460CE](#)