

● General Description

The AGM628M combines advanced trench MOSFET technology with a low resistance package to provide extremely low $R_{DS(ON)}$.

This device is ideal for load switch and battery protection applications.

● Features

- Advance high cell density Trench technology
- Low $R_{DS(ON)}$ to minimize conductive loss
- Low Gate Charge for fast switching
- Low Thermal resistance

● Application

- MB/VGA Vcore
- SMPS 2nd Synchronous Rectifier
- POL application
- BLDC Motor driver

Product Summary

BVDSS	RDSON	ID
60V	27mΩ	6.8A
-60V	53mΩ	-5.7A

SOP8 Pin Configuration

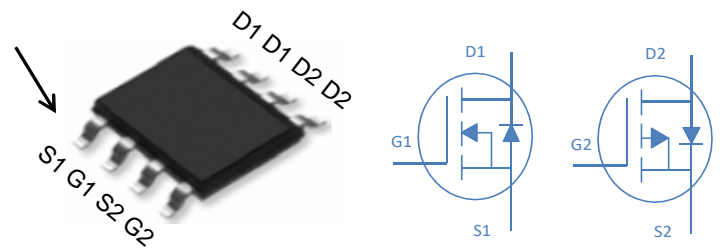

Package Marking and Ordering Information

Device Marking	Device	Device Package	Reel Size	Tape width	Quantity
AGM628M	AGM628M	SOP8	--mm	--mm	3000

Table 1. Absolute Maximum Ratings (TA=25°C)

Symbol	Parameter	Rating		Units
		N-Ch	P-Ch	
V_{DS}	Drain-Source Voltage ($V_{GS}=0V$)	60	-60	V
V_{GS}	Gate-Source Voltage ($V_{DS}=0V$)	±20	±20	V
I_D	Drain Current-Continuous($T_c=25^\circ C$) (Note 1)	6.8	-5.7	A
	Drain Current-Continuous($T_c=100^\circ C$)	3.2	-2.6	A
IDM (pluse)	Drain Current-Continuous@ Current-Pulsed (Note 2)	9.6	-7.5	A
P_D	Total Power Dissipation($T_c=25^\circ C$)	3.5	3.5	W
	Total Power Dissipation($T_c=100^\circ C$)	1.4	1.4	W
EAS	Avalanche energy (Note 3)	22	18	mJ
TJ,TSTG	Operating Junction and Storage Temperature Range	-55 To 150	-55 To 150	°C

Table 2. Thermal Characteristic

Symbol	Parameter	Typ	Max	Unit
$R_{\theta JA}$	Thermal Resistance Junction-ambient (Steady State) ¹	---	85	°C/W
$R_{\theta JC}$	Thermal Resistance Junction-Case ¹	---	36	°C/W

Table 3. N- Channel Electrical Characteristics (TA=25°C unless otherwise noted)

Symbol	Parameter	Conditions	Min	Typ	Max	Unit
On/Off States						
BVDSS	Drain-Source Breakdown Voltage	VGS=0V ID=250μA	60	--	--	V
IDSS	Zero Gate Voltage Drain Current	VDS=60V, VGS=0V	--	--	1	μA
IGSS	Gate-Body Leakage Current	VGS=±20V, VDS=0V	--	--	±100	nA
VGS(th)	Gate Threshold Voltage	VDS=VGS, ID=250μA	1.0	1.6	2.5	V
gFS	Forward Transconductance	VDS=5V, ID=6A	--	35	--	S
RDS(on)	Drain-Source On-State Resistance	VGS=10V, ID=6A	--	27	40	mΩ
		VGS=4.5V, ID=5A	--	36	50	mΩ
Dynamic Characteristics						
Ciss	Input Capacitance	VDS=30V, VGS=0V, F=1MHZ	--	916	--	pF
Coss	Output Capacitance		--	42	--	pF
Crss	Reverse Transfer Capacitance		--	38	--	pF
Rg	Gate resistance	VGS=0V, VDS=0V, f=1.0MHz	--	--	--	Ω
Switching Times						
td(on)	Turn-on Delay Time	VGS=10V, VDS=30V, RL=2.5Ω, RGEN=3Ω	--	4.5	--	nS
tr	Turn-on Rise Time		--	18	--	nS
td(off)	Turn-Off Delay Time		--	14.5	--	nS
tf	Turn-Off Fall Time		--	18	--	nS
Qg	Total Gate Charge	VGS=10V, VDS=30V, ID=3A	--	19	--	nC
Qgs	Gate-Source Charge		--	4.2	--	nC
Qgd	Gate-Drain Charge		--	2.5	--	nC
Source-Drain Diode Characteristics						
ISD	Source-Drain Current(Body Diode)		--	--	6.8	A
VSD	Forward on Voltage	VGS=0V, IS=2A	--	0.8	1.2	V
trr	Reverse Recovery Time	IF=2A , dI/dt=100A/μs , TJ=25°C	--	--	--	ns
Qrr	Reverse Recovery Charge		--	--	--	nc

Notes 1.The maximum current rating is package limited.

Notes 2.Repetitive Rating: Pulse width limited by maximum junction temperature

Notes 3.EAS condition: TJ=25°C

Table 3. P-Channel Electrical Characteristics (TA=25°C unless otherwise noted)

Symbol	Parameter	Conditions	Min	Typ	Max	Unit
On/Off States						
BVDSS	Drain-Source Breakdown Voltage	VGS=0V ID=-250μA	-60	--	--	V
IDSS	Zero Gate Voltage Drain Current	VDS=-60V,VGS=0V	--	--	-1	μA
IGSS	Gate-Body Leakage Current	VGS=±20V,VDS=0V	--	--	±100	nA
VGS(th)	Gate Threshold Voltage	VDS=VGS,ID=-250μA	-1.1	-1.7	-2.5	V
gFS	Forward Transconductance	VDS=-10V,ID=-2A	--	32	--	S
RDS(on)	Drain-Source On-State Resistance	VGS=-10V, ID=-6A	--	53	67	mΩ
		VGS=-4.5V, ID=-5A	--	67	88	mΩ
Dynamic Characteristics						
Ciss	Input Capacitance	VDS=-30V,VGS=0V, F=1MHZ	--	1200	--	pF
Coss	Output Capacitance		--	75	--	pF
Crss	Reverse Transfer Capacitance		--	58	--	pF
Rg	Gate resistance	VGS=0V, VDS=0V,f=1.0MHz	--	7	--	Ω
Switching Times						
td(on)	Turn-on Delay Time	VGS=-10V,VDS=-30V, RGEN=3Ω	--	--	--	nS
tr	Turn-on Rise Time		--	--	--	nS
td(off)	Turn-Off Delay Time		--	--	--	nS
tf	Turn-Off Fall Time		--	--	--	nS
Qg	Total Gate Charge	VGS=-10V, VDS=-30V, ID=-3A	--	25	--	nC
Qgs	Gate-Source Charge		--	5.8	--	nC
Qgd	Gate-Drain Charge		--	3.1	--	nC
Source-Drain Diode Characteristics						
ISD	Source-Drain Current(Body Diode)		--	--	-5.7	A
VSD	Forward on Voltage	VGS=0V,IS=-2A	--	-0.8	-1.2	V
trr	Reverse Recovery Time	IF=-2A , dl/dt=100A/μs , TJ=25°C	--	--	--	ns
Qrr	Reverse Recovery Charge		--	--	--	nc

Notes 1.The maximum current rating is package limited.

Notes2.Repetitive Rating: Pulse width limited by maximum junction temperature Notes

3.EAS condition: TJ=25°C

N-Channel Typical Characteristics

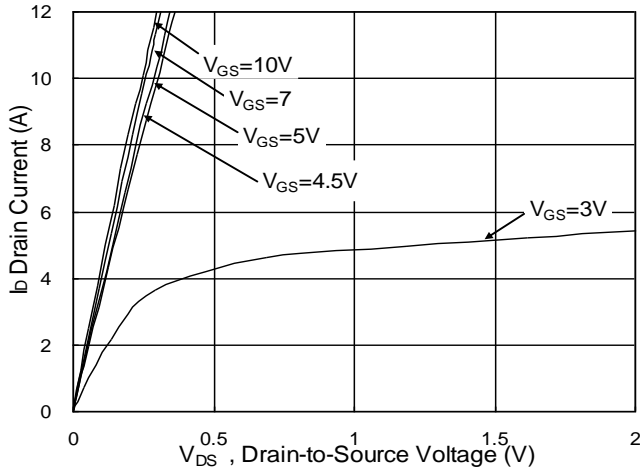

Fig.1 Typical Output Characteristics

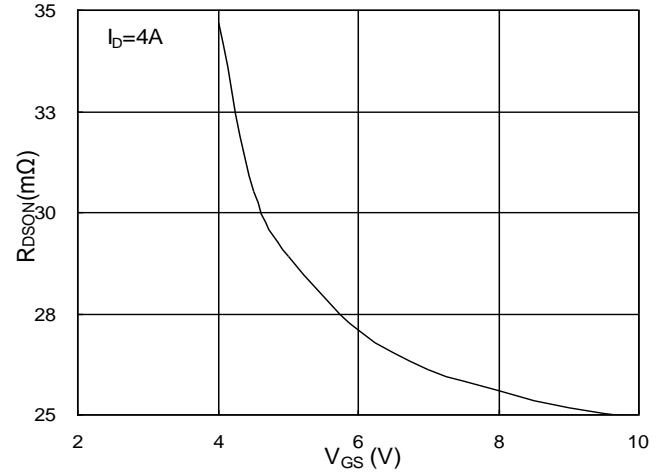

Fig.2 On-Resistance v.s Gate-Source

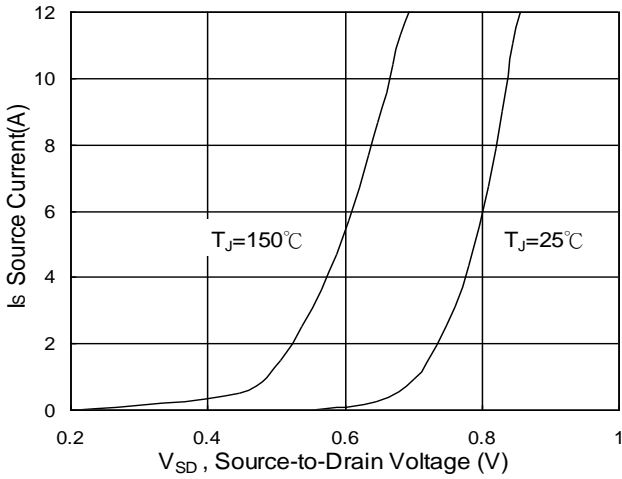

Fig.3 Forward Characteristics of Reverse

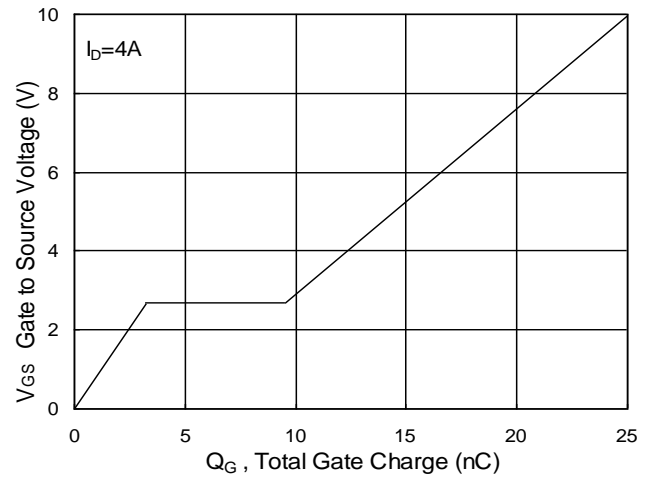

Fig.4 Gate-Charge Characteristics

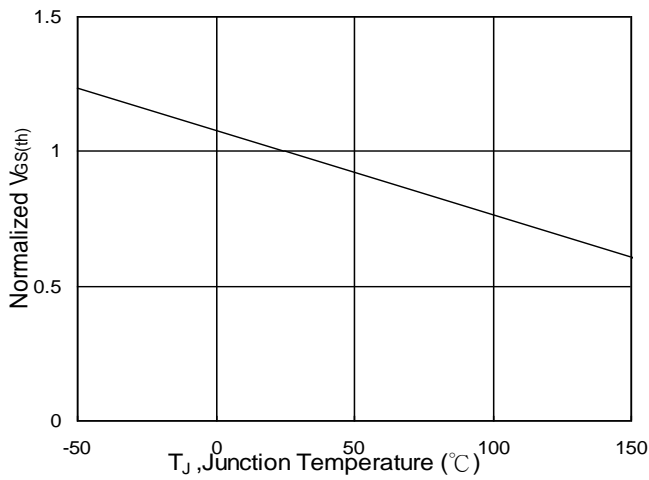

Fig.5 Normalized V_{GS(th)} v.s T_J

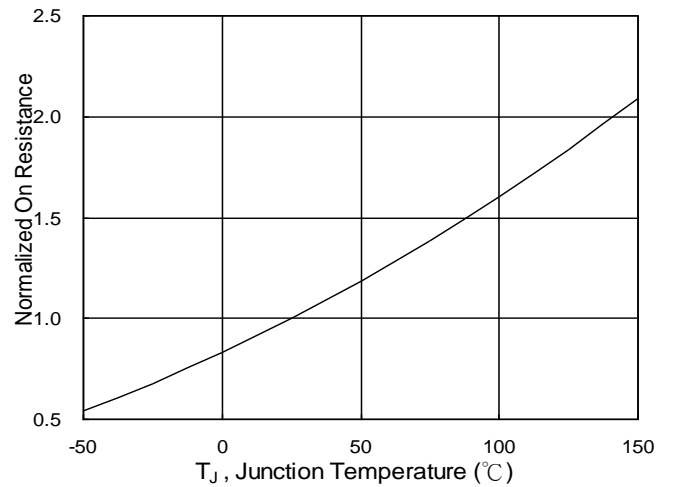

Fig.6 Normalized R_{DS(on)} v.s T_J

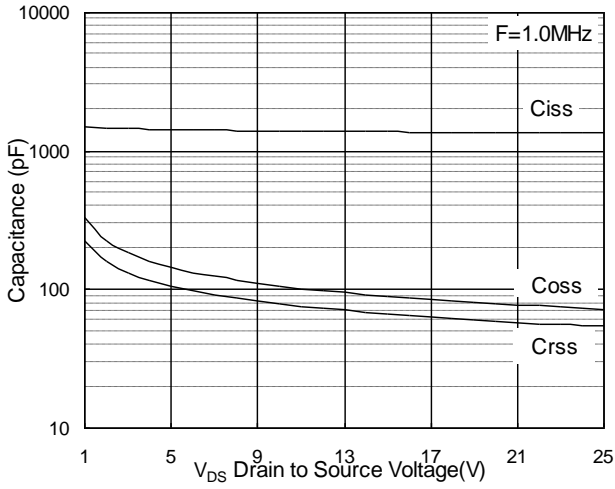

Fig.7 Capacitance

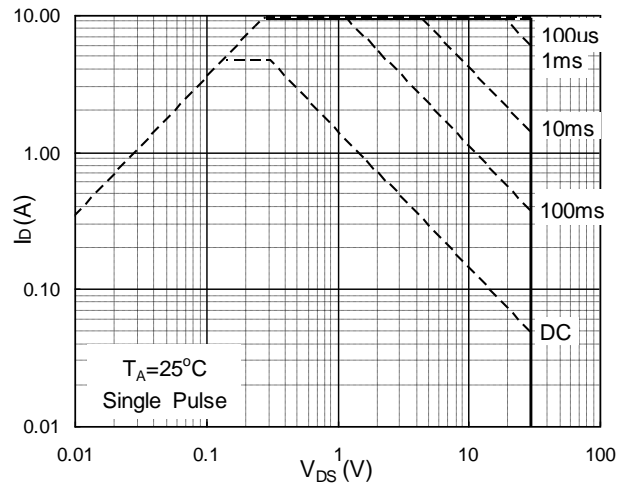

Fig.8 Safe Operating Area

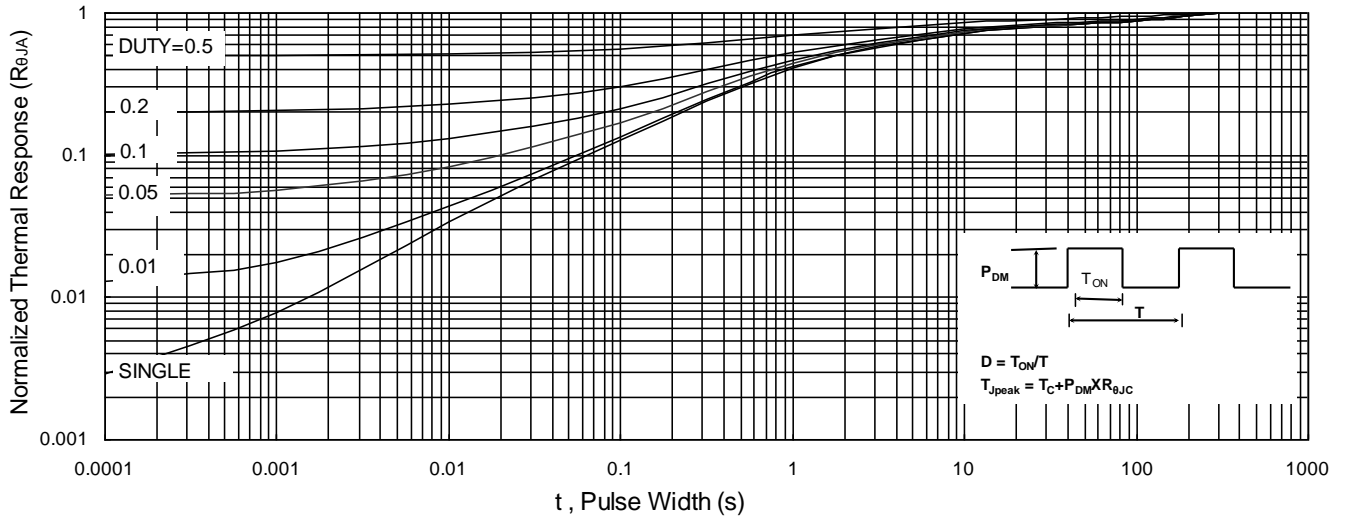

Fig.9 Normalized Maximum Transient Thermal Impedance

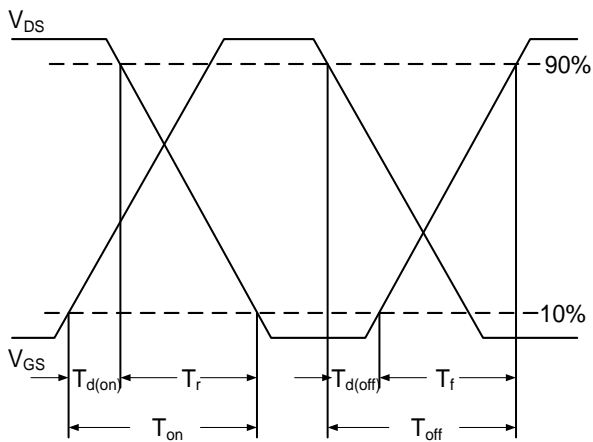

Fig.10 Switching Time Waveform

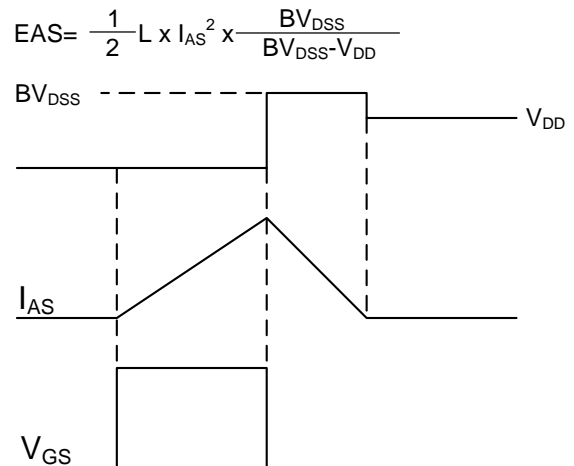

Fig.11 Unclamped Inductive Waveform

P-Channel Typical Characteristics

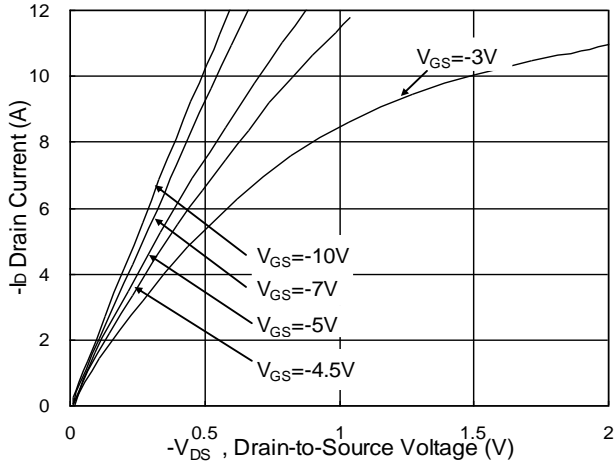

Fig.1 Typical Output Characteristics

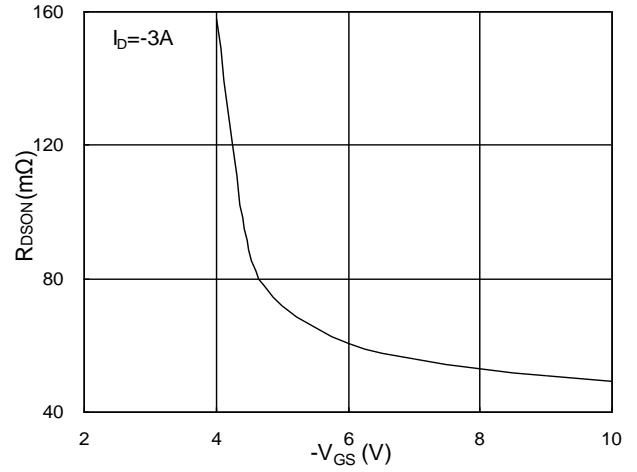

Fig.2 On-Resistance v.s Gate-Source

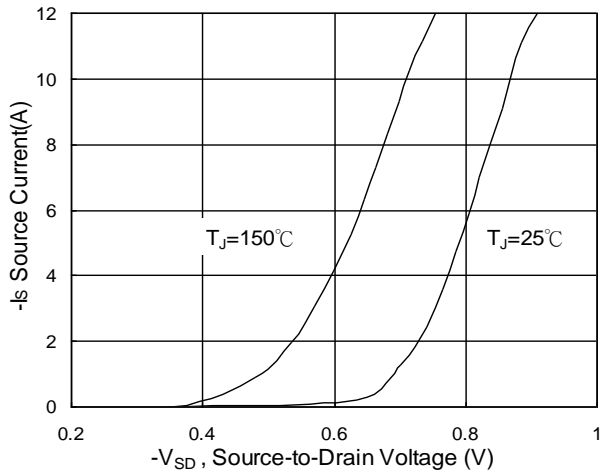

Fig.3 Forward Characteristics of Reverse

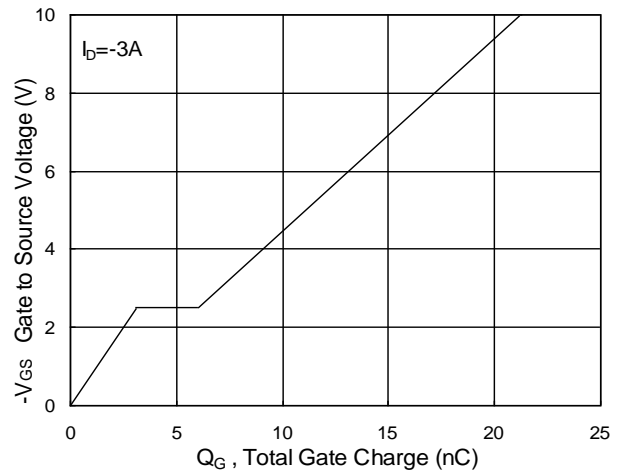

Fig.4 Gate-Charge Characteristics

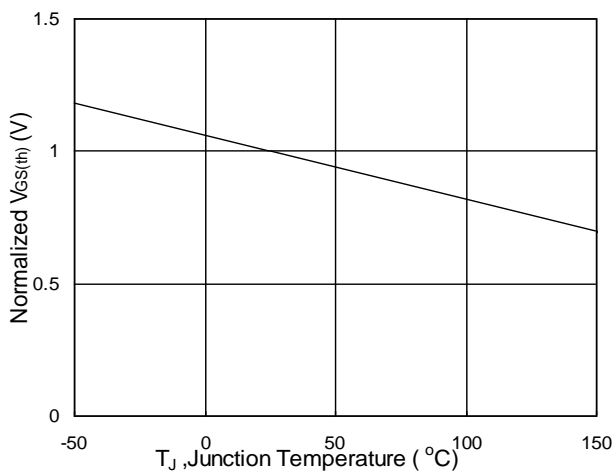

Fig.5 Normalized $V_{GS(th)}$ v.s T_J

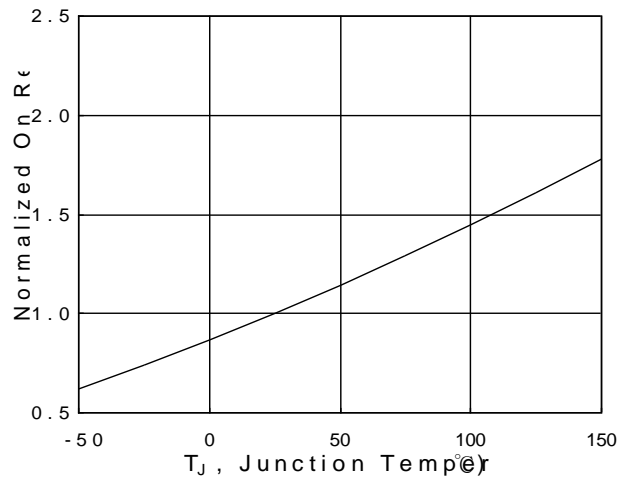
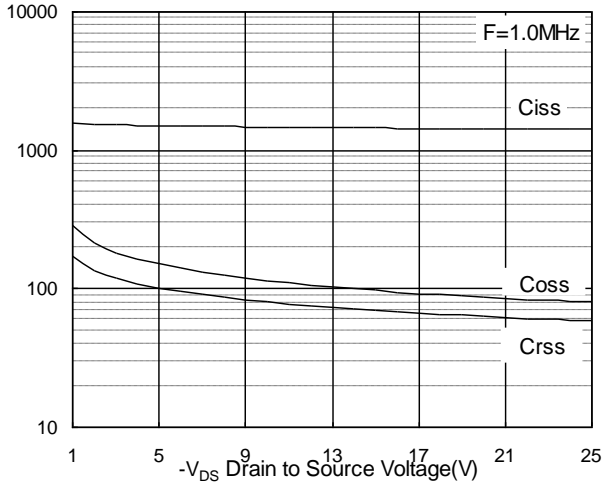
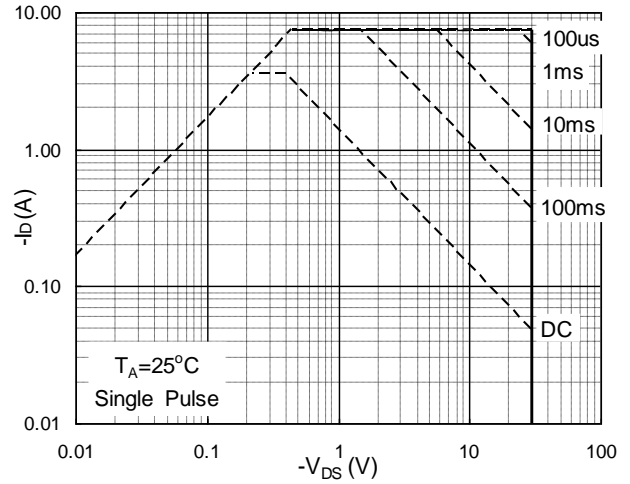
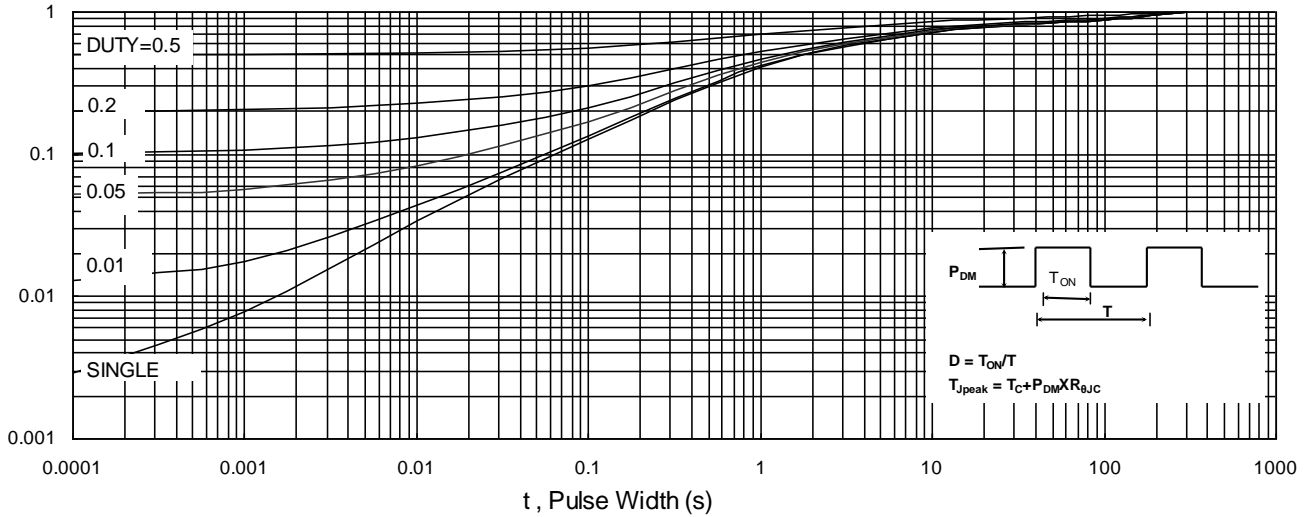
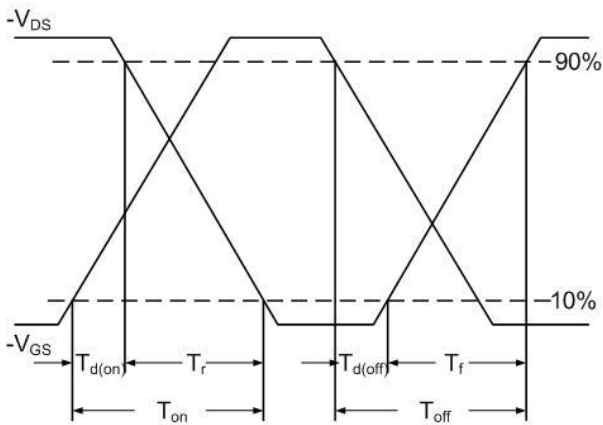
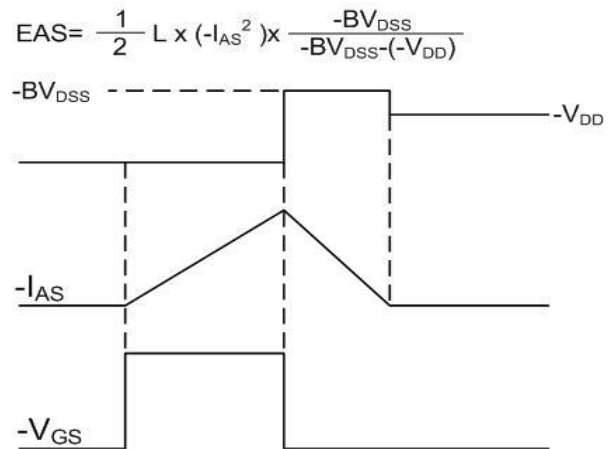

Fig.6 Normalized $R_{DS(on)}$ v.s T_J

P-Channel Typical Characteristics

Fig.7 Capacitance

Fig.8 Safe Operating Area

Fig.9 Normalized Maximum Transient Thermal Impedance

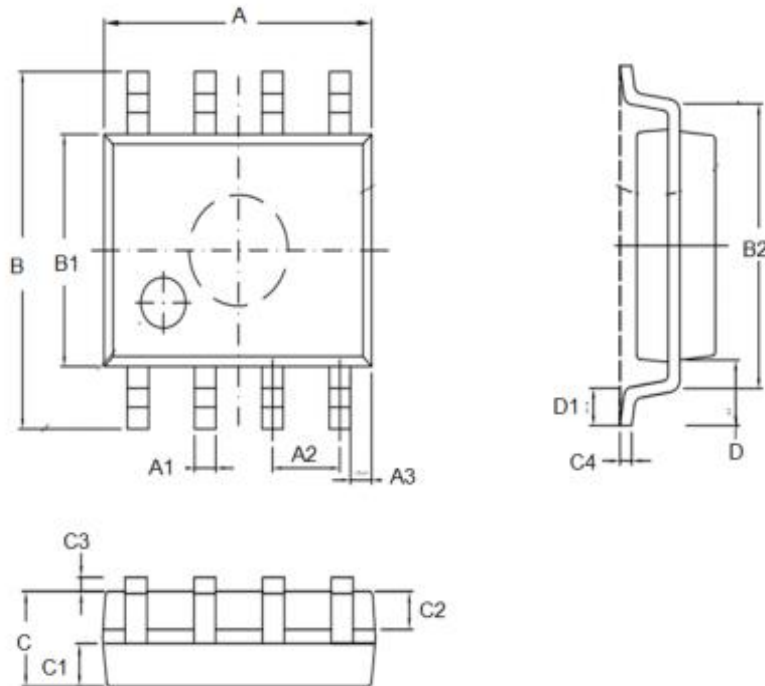
Fig.10 Switching Time Waveform

Fig.11 Unclamped Inductive Waveform

•Dimensions(SOP8)

SYMBOL	min	TYP	max	SYMBOL	min		max
A	4.80		5.00	C	1.30		1.50
A1	0.37		0.47	C1	0.55		0.75
A2		1.27		C2	0.55		0.65
A3		0.41		C3	0.05		0.20
B	5.80		6.20	C4	0.19	0.20	0.23
B1	3.80		4.00	D		1.05	
B2		5.00		D1	0.40		0.62



Disclaimer:

The information provided in this document is believed to be accurate and reliable. however, Shenzhen Core Control Electronics Technology Co., Ltd. does not assume any responsibility for the following consequences Do not consider the use of such information or use beyond its scope.

The information mentioned in this document may be changed at any time without notice.

The products and information provided in this document do not infringe patents. Shenzhen Core Control Electronics Technology Co., Ltd. assumes no responsibility for any infringement of any other rights of third parties. The result of using such products and information.

This document is the second version issued on June 10, 2022. This document replaces and Replace all previously provided information.

 It is a registered trademark of Shenzhen Core Control Electronics Technology Co., Ltd.

Copyright © 2017 Shenzhen Core Control Electronics Technology Co., Ltd. all rights reserved.

X-ON Electronics

Largest Supplier of Electrical and Electronic Components

Click to view similar products for [MOSFET](#) category:

Click to view products by [AGM-Semi](#) manufacturer:

Other Similar products are found below :

[IRFD120](#) [JANTX2N5237](#) [BUK455-60A/B](#) [MIC4420CM-TR](#) [VN1206L](#) [NDP4060](#) [SI4482DY](#) [IPS70R2K0CEAKMA1](#) [SQD23N06-31L-GE3](#)
[TK16J60W,S1VQ\(O](#) [2SK2614\(TE16L1,Q\)](#) [DMN1017UCP3-7](#) [DMN1053UCP4-7](#) [SQJ469EP-T1-GE3](#) [NTE2384](#) [DMC2700UDMQ-7](#)
[DMN2080UCB4-7](#) [DMN61D9UWQ-13](#) [US6M2GTR](#) [DMN31D5UDJ-7](#) [DMP22D4UFO-7B](#) [DMN1006UCA6-7](#) [DMN16M9UCA6-7](#)
[STF5N65M6](#) [IRF40H233XTMA1](#) [STU5N65M6](#) [DMN6022SSD-13](#) [DMN13M9UCA6-7](#) [DMTH10H4M6SPS-13](#) [DMN2990UFB-7B](#)
[IPB80P04P405ATMA2](#) [2N7002W-G](#) [MCAC30N06Y-TP](#) [MCQ7328-TP](#) [NTMC083NP10M5L](#) [BXP7N65D](#) [BXP4N65F](#) [AOL1454G](#)
[WMJ80N60C4](#) [BXP2N20L](#) [BXP2N65D](#) [BXT1150N10J](#) [BXT1700P06M](#) [TSM60NB380CP](#) [ROG](#) [RQ7L055BGTGR](#) [DMNH15H110SK3-13](#)
[SLF10N65ABV2](#) [BSO203SP](#) [BSO211P](#) [IPA60R230P6](#)