

• General Description

The AGMH022P10H combines advanced trench MOSFET technology with a low resistance package to provide extremely low $R_{DS(ON)}$.

This device is ideal for load switch and battery protection applications.

• Features

- Advance high cell density Trench technology
- Low $R_{DS(ON)}$ to minimize conductive loss
- Low Gate Charge for fast switching
- Low Thermal resistance
- 100% Avalanche tested
- 100% DVDS tested

• Application

- MB/VGA Vcore
- SMPS 2nd Synchronous Rectifier
- POL application
- BLDC Motor driver

Product Summary

BVDSS	RDSON	ID
-100V	20mΩ	-65A

TO-263 Pin Configuration

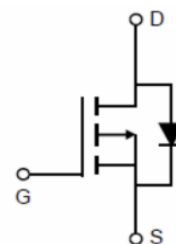
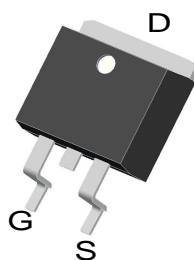

Package Marking and Ordering Information

Device Marking	Device	Device Package	Reel Size	Tape width	Quantity
AGMH022P10H	AGMH022P10H	TO-263	330mm	25mm	800

Table 1. Absolute Maximum Ratings (Tc=25°C)

Symbol	Parameter	Value	Unit
VDS	Drain-Source Voltage (VGS=0V)	-100	V
VGS	Gate-Source Voltage (VDS=0V)	±20	V
ID	Drain Current-Continuous(Tc=25°C) (Note 1)	-65	A
	Drain Current-Continuous(Tc=100°C)	-41	A
IDM (pluse)	Drain Current-Continuous@ Current-Pulsed (Note 2)	-260	A
PD	Maximum Power Dissipation(Tc=25°C)	250	w
	Maximum Power Dissipation(Tc=100°C)	100	w
EAS	Avalanche energy (Note 3)	465	mJ
TJ,TSTG	Operating Junction and Storage Temperature Range	-55 To 150	°C

Table 2. Thermal Characteristic

Symbol	Parameter	Typ	Max	Unit
RθJA	Thermal Resistance Junction-ambient (Steady State) ¹	---	62	°C/W
RθJC	Thermal Resistance Junction-Case ¹	---	0.5	°C/W

Table 2. P-Channel Electrical Characteristics (T_J=25°C unless otherwise noted)

Symbol	Parameter	Conditions	Min	Typ	Max	Unit
On/Off States						
BVDSS	Drain-Source Breakdown Voltage	VGS=0V ID=-250μA	-100	--	--	V
IDSS	Zero Gate Voltage Drain Current	VDS=-100V,VGS=0V	--	--	1	μA
IGSS	Gate-Body Leakage Current	VGS=±20V,VDS=0V	--	--	±100	nA
VGS(th)	Gate Threshold Voltage	VDS=VGS,ID=-250μA	-2	-3	-4	V
gFS	Forward Transconductance	VDS=-5V,ID=-5A	--	18	--	S
RDS(on)	Drain-Source On-State Resistance	VGS=-10V, ID=-10A	--	20	30	mΩ
Dynamic Characteristics						
Ciss	Input Capacitance	VDS=-50V,VGS=0V, F=1MHZ	--	4276	--	pF
Coss	Output Capacitance		--	336	--	pF
Crss	Reverse Transfer Capacitance		--	25	--	pF
Rg	Gate resistance	VGS=0V	--	19	--	Ω
Switching Times						
td(on)	Turn-on Delay Time	ID =-20A VDS = -50V VGS = -10V RG = 5Ω	--	15	--	nS
tr	Turn-on Rise Time		--	18	--	nS
td(off)	Turn-Off Delay Time		--	50	--	nS
tf	Turn-Off Fall Time		--	19	--	nS
Qg	Total Gate Charge	VGS=-10V, VDS=-50V, ID=-20A	--	52.1	--	nC
Qgs	Gate-Source Charge		--	16.7	--	nC
Qgd	Gate-Drain Charge		--	7.1	--	nC
Source-Drain Diode Characteristics						
ISD	Source-Drain Current(Body Diode)		--	--	-65	A
VSD	Forward on Voltage	VGS=0V,IS=-10A	--	--	-1.2	V
trr	Reverse Recovery Time	IS=-10A, VDD=-50V dI/dt=100A/μs	--	55	--	ns
Qrr	Reverse Recovery Charge		--	102	--	nc

Notes 1.The maximum current rating is package limited.

Notes 2.Repetitive Rating: Pulsewidth limited by maximum junction temperature Notes

3.EAS condition: T_J=25°C

Characteristics Curve:

Typ. output characteristics
 $-I_D = f(-V_{DS})$

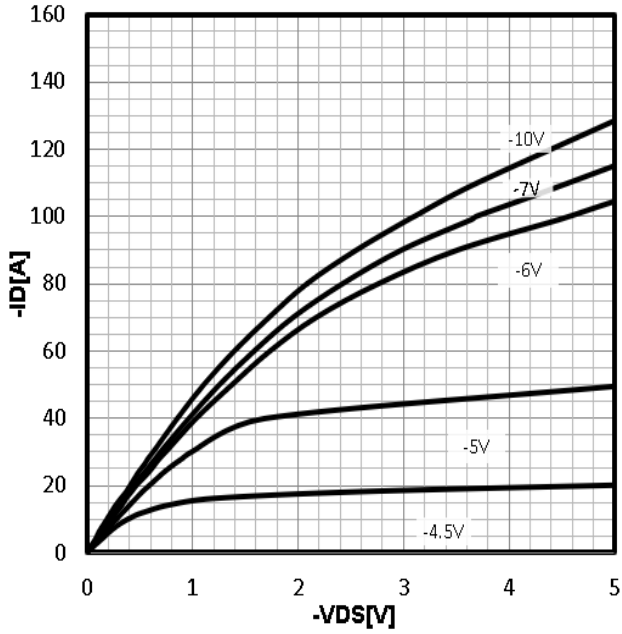

Typ. drain-source on resistance
 $R_{DS(on)} = f(-I_D)$

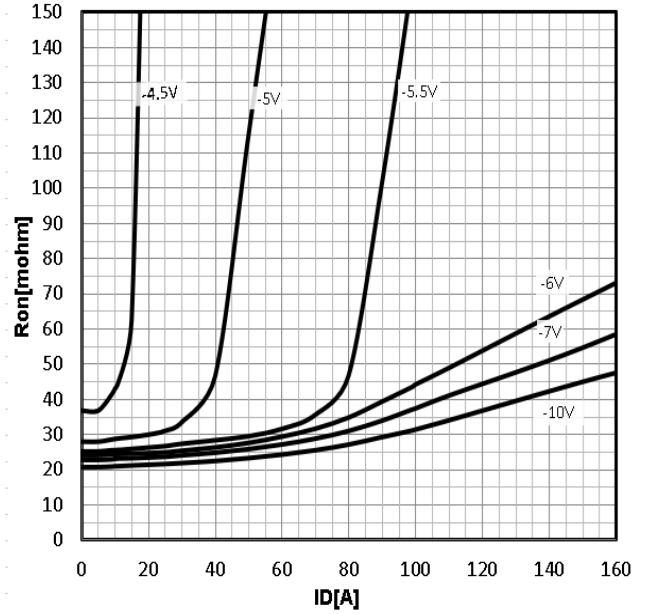

Typ. transfer characteristics
 $-I_D = f(-V_{GS})$

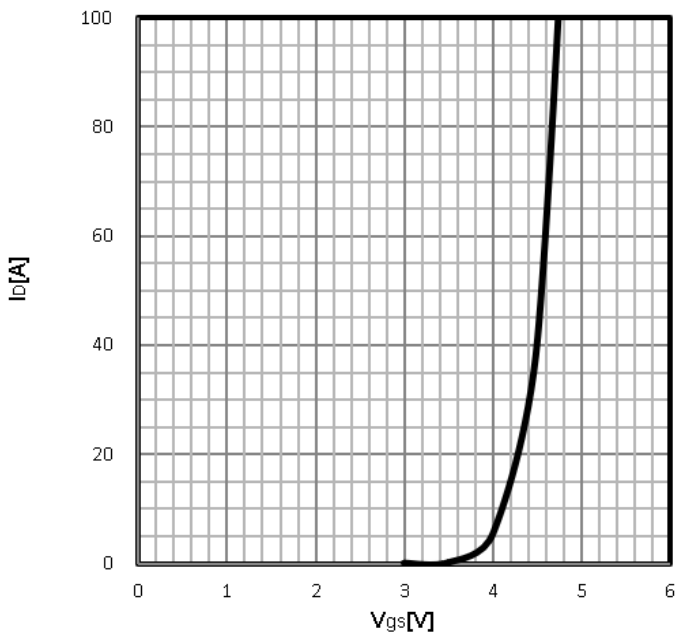

Drain-source on-state resistance
 $R_{DS(on)} = f(T_j); I_D = -10A; V_{GS} = -10V$

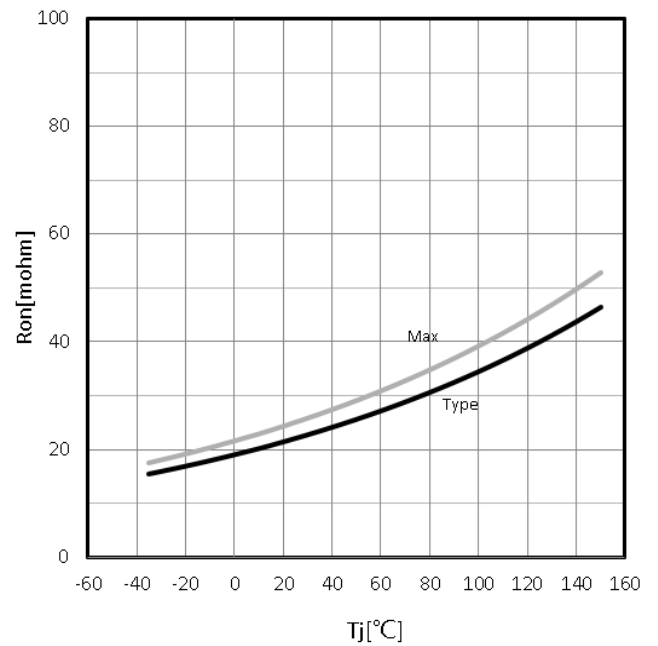

Gate Threshold Voltage
 $-V_{TH}=f(T_j); I_D=-250\mu A$

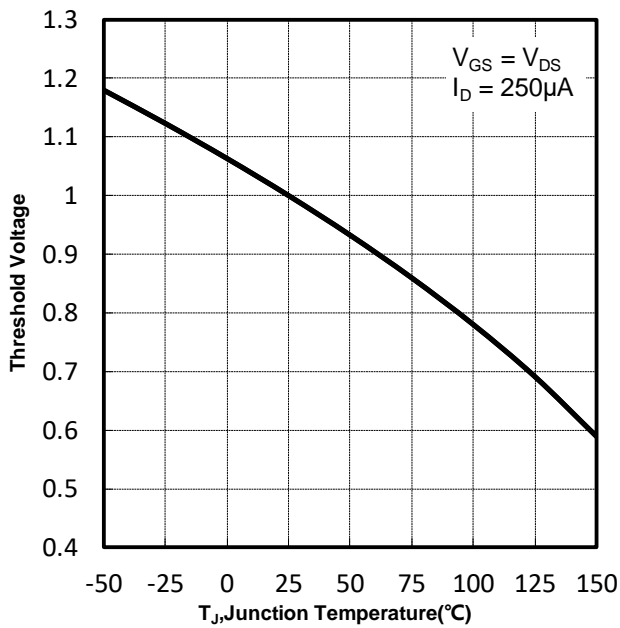

Drain-source breakdown voltage
 $-V_{BR(DSS)}=f(T_j); I_D=-250\mu A$

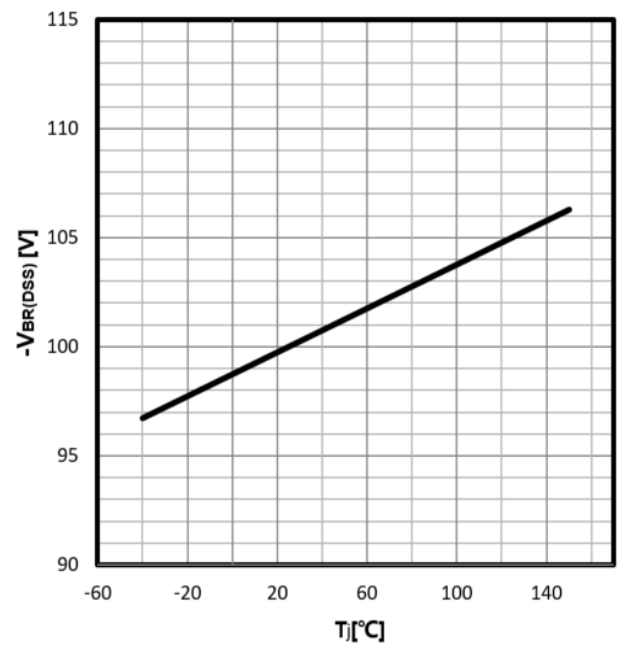

Typ. gate charge
 $-V_{GS}=f(Q_g); I_D=-20A$

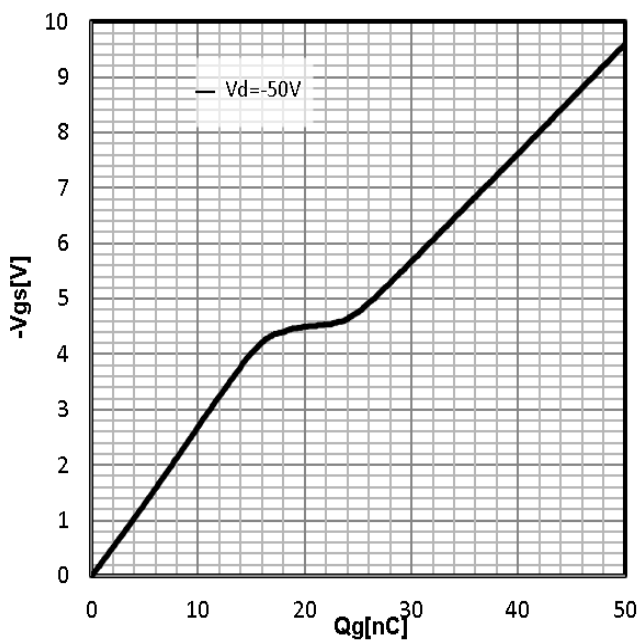

Typ. capacitances
 $C=f(-V_{DS}); V_{GS}=0V; f=1MHz$

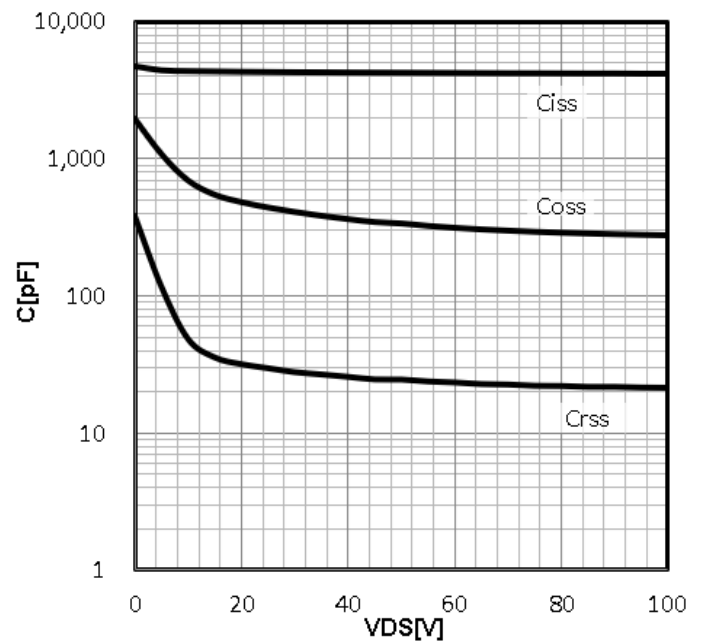

Power Dissipation

$$P_{tot}=f(T_C)$$

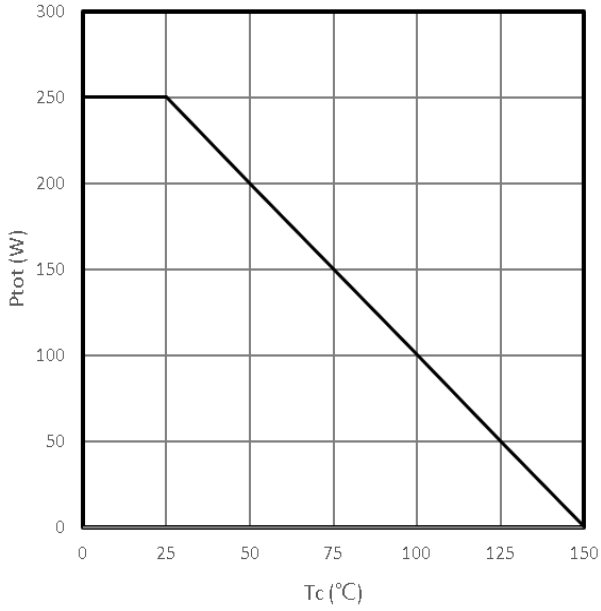
Maximum Drain Current

$$-I_D=f(T_C)$$

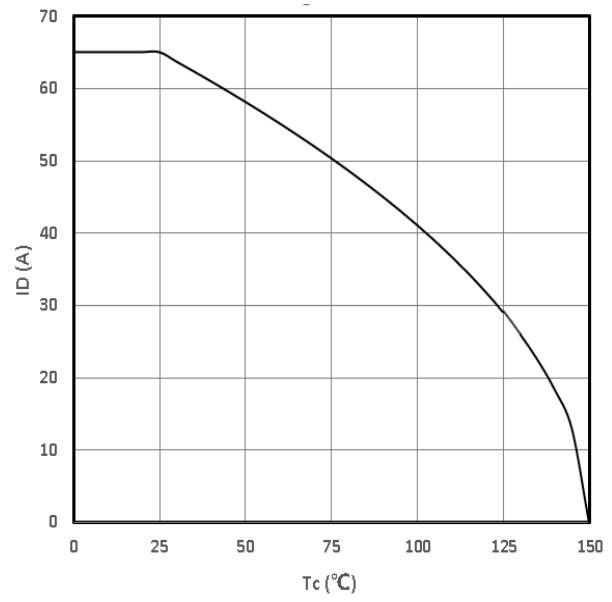
Safe operating area

$$-I_D=f(-V_{DS})$$

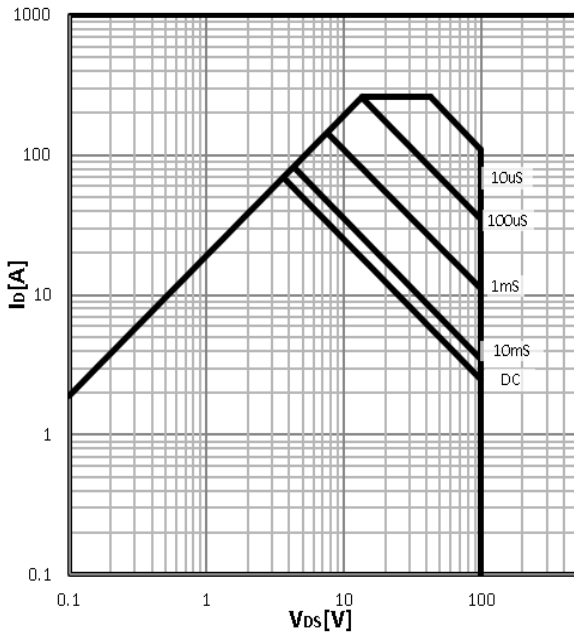

Body Diode Forward Voltage Variation

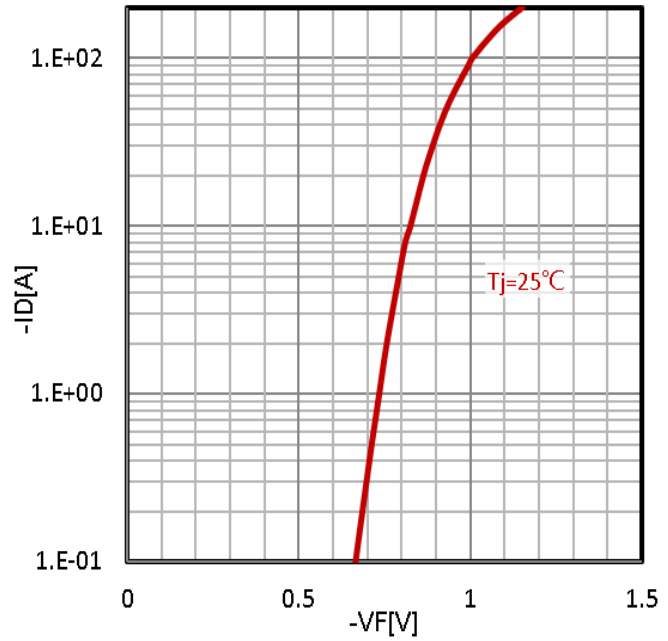
$$-I_F=f(-V_{DS})$$

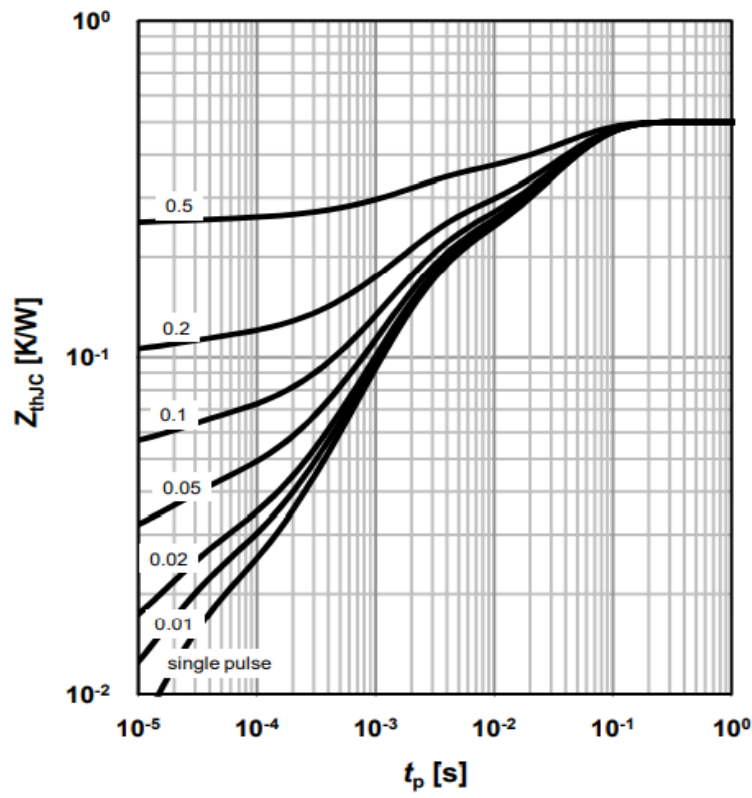

Max. transient thermal impedance
 $Z_{thJC}=f(t_p)$

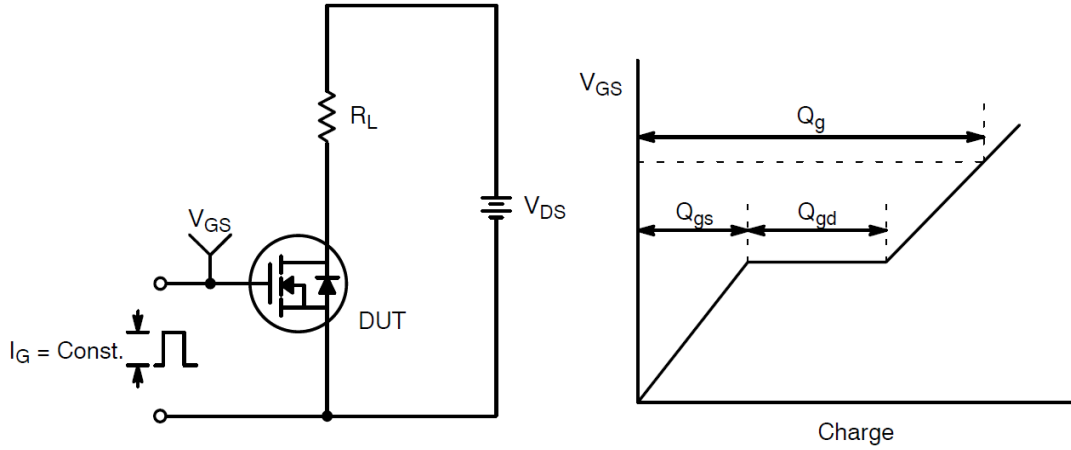
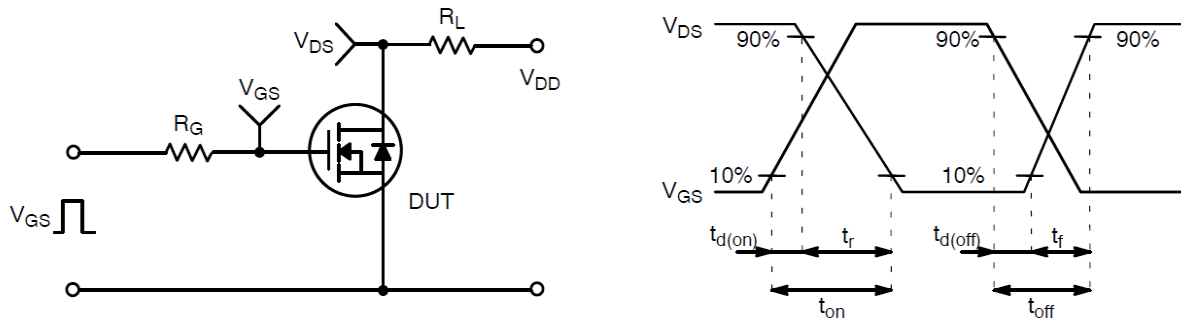
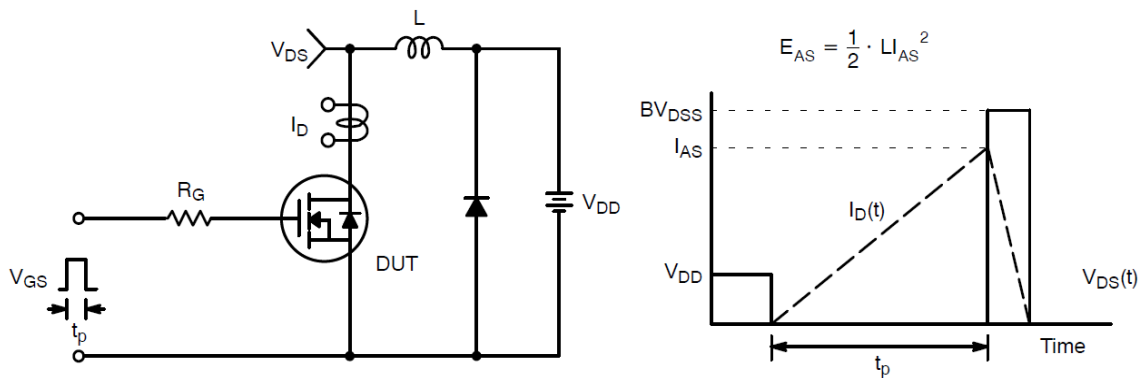

Test Circuit and Waveform:

Gate Charge Test Circuit & Waveform

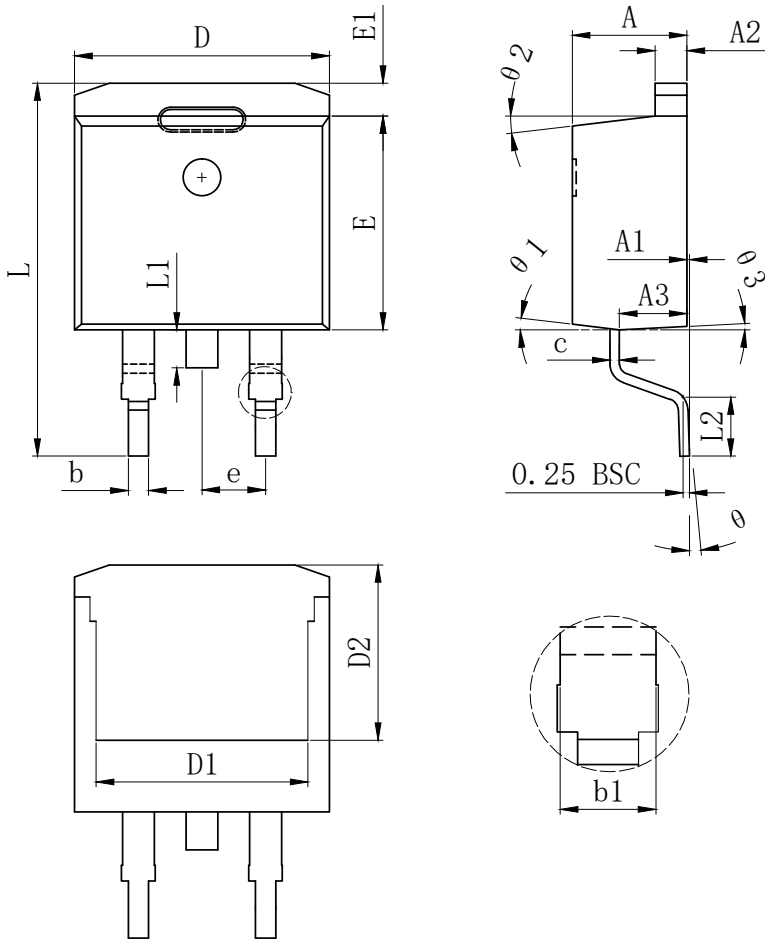
Resistive Switching Test Circuit & Waveforms

Unclamped Inductive Switching Test Circuit & Waveforms

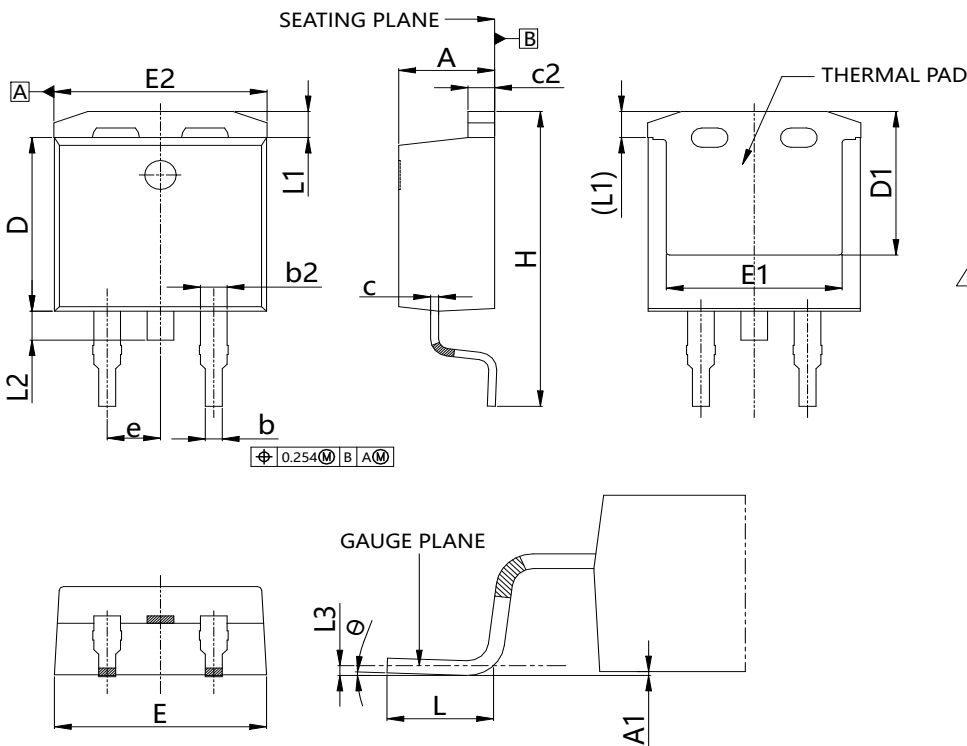
TO-263 PACKAGE INFORMATION



SYMBOL	MILLIMETER		
	MIN	Typ.	MAX
A	4.370	4.570	4.770
A1	0.000		0.250
A2	1.220	1.270	1.420
A3	2.490	2.690	2.890
b	0.700	0.810	0.960
b1	1.170	1.270	1.470
c	0.300	0.380	0.530
D	9.860	10.160	10.360
D1	8.400 REF		
D2	7.073 REF		
E	8.500	8.700	8.900
E1	1.070	1.270	1.470
e	2.540 TYP		
L	14.700	15.100	15.500
L1	1.400	1.550	1.700
L2	2.000	2.300	2.600
θ	0°		9°
θ_1	7° TYP		
θ_2	7° TYP		
θ_3	3° TYP		



SYMBOL	MILLIMETER		
	MIN.	NOMINAL	MAX.
A	4.47	4.57	4.67
A1	0.00	0.10	0.25
b	0.71	0.81	0.91
b2	1.17	1.27	1.37
c	0.360	0.381	0.500
c2	1.17	1.27	1.37
D	8.70	9.00	9.30
D1	7.10	7.44	7.80
E	9.90	10.11	10.30
E1	8.08	8.38	8.68
E2	10.00	10.16	10.30
e	2.44	2.54	2.64
H	15.00	15.28	15.60
L	2.25	2.54	2.80
L1	1.10	1.35	1.60
L2	---	---	1.78
L3	0.254 BSC		
θ	0°	---	8°

Disclaimer:

The information provided in this document is believed to be accurate and reliable. however, Shenzhen Core Control Electronics Technology Co., Ltd. does not assume any responsibility for the following consequences. Do not consider the use of such information or use beyond its scope.

The information mentioned in this document may be changed at any time without notice.

The products and information provided in this document do not infringe patents. Shenzhen Core Control Electronics Technology Co., Ltd. assumes no responsibility for any infringement of any other rights of third parties. The result of using such products and information.

This document is the first version issued on July 20th, 2023. This document replaces all previously provided information.

 It is a registered trademark of Shenzhen Core Control Electronics Technology Co., Ltd.

Copyright © 2017 Shenzhen Core Control Electronics Technology Co., Ltd. all rights reserved.

X-ON Electronics

Largest Supplier of Electrical and Electronic Components

Click to view similar products for [MOSFET](#) category:

Click to view products by [AGM-Semi](#) manufacturer:

Other Similar products are found below :

[IRFD120](#) [JANTX2N5237](#) [BUK455-60A/B](#) [MIC4420CM-TR](#) [VN1206L](#) [NDP4060](#) [SI4482DY](#) [IPS70R2K0CEAKMA1](#) [SQD23N06-31L-GE3](#)
[TK16J60W,S1VQ\(O](#) [2SK2614\(TE16L1,Q\)](#) [DMN1017UCP3-7](#) [DMN1053UCP4-7](#) [SQJ469EP-T1-GE3](#) [NTE2384](#) [DMC2700UDMQ-7](#)
[DMN2080UCB4-7](#) [DMN61D9UWQ-13](#) [US6M2GTR](#) [DMN31D5UDJ-7](#) [DMP22D4UFO-7B](#) [DMN1006UCA6-7](#) [DMN16M9UCA6-7](#)
[STF5N65M6](#) [IRF40H233XTMA1](#) [STU5N65M6](#) [DMN6022SSD-13](#) [DMN13M9UCA6-7](#) [DMTH10H4M6SPS-13](#) [DMN2990UFB-7B](#)
[IPB80P04P405ATMA2](#) [2N7002W-G](#) [MCAC30N06Y-TP](#) [MCQ7328-TP](#) [BXP7N65D](#) [BXP4N65F](#) [AOL1454G](#) [WMJ80N60C4](#) [BXP2N20L](#)
[BXP2N65D](#) [BXT1150N10J](#) [BXT1700P06M](#) [TSM60NB380CP](#) [ROG](#) [RQ7L055BGTCR](#) [DMNH15H110SK3-13](#) [SLF10N65ABV2](#)
[BSO203SP](#) [BSO211P](#) [IPA60R230P6](#) [IPA60R460CE](#)