

300mA Linear Regulator With Bypass Pin

FEATURES

- Guarantee 300mA Output Current.
- Fast Response in Line/Load Transient
- Wide Operating Voltage Ranges: 2.0V to 6.0V.
- 0.01 μ A Shutdown Standby Current
- Low Quiescent Current : 80 μ A.
- Output Voltage is available within 1.1~4.2V
- Low Dropout : 270mV at 300mA
- PSRR : 60dB at 1kHz.
- Active High Shutdown Control.
- Fixed: 1.1, 1.2, 1.3, 1.5, 1.8, 2.5, 2.7, 2.8, 2.85, 3.0, 3.3, 3.5, 3.7, 3.8, 4.0 Output Voltage.Current Limit and Thermal Protection.
- Available in \pm 2% Output Tolerance.
- Available in 3 & 5 lead of SOT-23, TSOT23, SC70, & SOT-89 & DFN 6L 2x2 Package.

APPLICATIONS

- Cellular Phones.
- PCMCIA Cards
- Laptop, Palmtops, Notebook Computers
- Personal Communication Equipment.
- PDAs.
- Digital Still Cameras.
- Portable Consumer Equipments.

TYPICAL APPLICATION CIRCUIT

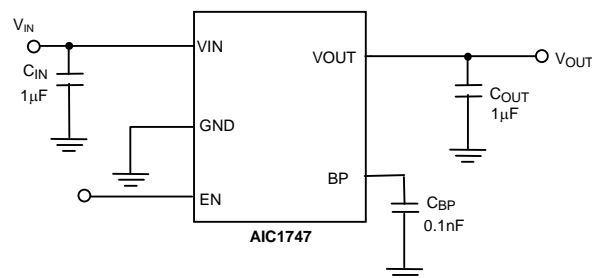

Ultra LDO Regulator

DESCRIPTION

AIC1747 is optimized for ceramic capacitor operation with 300mA continuous current. The AIC1747 is designed for portable RF and wireless applications with demanding performance and space requirements.

The AIC1747 offers high precision output voltage of \pm 2% tolerance. Output Voltage is available within 1.1~4.2V. There are version of 1.1, 1.2, 1.3, 1.5, 1.8, 2.5, 2.7, 2.8, 2.85, 3.0, 3.3, 3.5, 3.7, 3.8 and 4.0 for a fixed output voltage.

A noise bypass pin is available for further reduction of output noise. At 300mA load current, a 270mV dropout can be performed. The quality of low quiescent current and low dropout voltage makes the device ideal for battery power applications. The high ripple rejection and low noise of the AIC1747 provide enhanced performances for critical applications such as cellular phones, and PDAs.

In addition, a logic-level shutdown input is included, which reduce supply current to less than 0.01 μ A (typ.) in shutdown mode with fast turn-on & off time less than 50 μ s & 30 μ s. The AIC1747's current limit and thermal protection provide protection against any overload condition that would cause excessive junction temperatures.

ORDERING INFORMATION

3 pin:

AIC1747-XXXXX XX

PACKING TYPE
TR: TAPE & REEL
BG: BAG

PACKAGE TYPE
U3: SOT-23
X3A: SOT-89
X3T: SOT-89
K3: TSOT23
J3: SC70

P: Lead Free Commercial
G: Green Package

(SC70 is only available on Green Package)

OUTPUT VOLTAGE

- 11: 1.1V
- 12: 1.2V
- 13: 1.3V
- 15: 1.5V
- 18: 1.8V
- 25: 2.5V
- 27: 2.7V
- 28: 2.8V
- 285: 2.85V
- 30: 3.0V
- 33: 3.3V
- 35: 3.5V
- 37: 3.7V
- 38: 3.8V
- 40: 4.0V

(Of a unit of 0.1V within 1.1~4.2V, additional voltage versions are available on demand)

Example: AIC1747-18GX3ATR

- 1.8V Version, in SOT-89 Green Package & Tape & Reel Packing Type

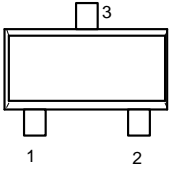
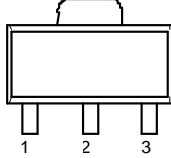
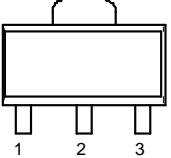
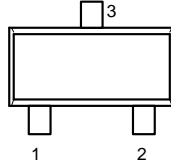
3 PIN CONFIGURATION	
SOT-23/TSOT23 TOP VIEW 1: GND 2: VOUT 3: VIN	
SOT-89 (X3A) TOP VIEW 1: GND 2: VIN 3: VOUT	
SOT-89 (X3T) TOP VIEW 1: VOUT 2: GND 3: VIN	
SC70 TOP VIEW 1: GND 2: VOUT 3: VIN	

■ ORDERING INFORMATION (Continued)

5 pin:

AIC1747-XXXXX XX

PACKING TYPE
TR: TAPE & REEL
BG: BAG

PACKAGE TYPE
V5 : SOT-23-5
V5N : SOT-23-5
X5 : SOT-89-5
K5 : TSOT23-5
K5N : TSOT23-5
J5 : SC70-5
DA : DFN 6L 2x2

P: Lead Free Commercial
G: Green Package

(SC-70 and DFN are only available on Green Package)

OUTPUT VOLTAGE

- 11: 1.1V
- 12: 1.2V
- 13: 1.3V
- 15: 1.5V
- 18: 1.8V
- 25: 2.5V
- 27: 2.7V
- 28: 2.8V
- 285: 2.85V
- 30: 3.0V
- 33: 3.3V
- 35: 3.5V
- 37: 3.7V
- 38: 3.8V
- 40: 4.0V

(Of a unit of 0.1V within 1.1~4.2V, additional voltage versions are available on demand)

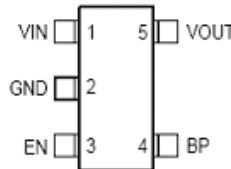
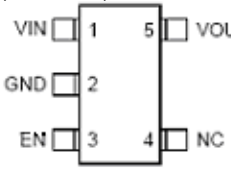
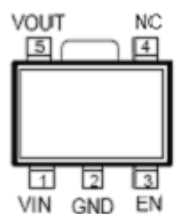
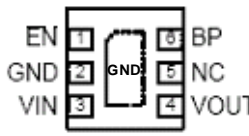
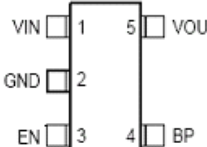
5 PIN CONFIGURATION	
<p>SOT-23-5/TSOT23-5(V5/K5) TOP VIEW</p> <p>1: VIN 2: GND 3: EN 4: BP 5: VOUT</p> 	
<p>SOT-23-5/TSOT23-5(V5N/K5N) TOP VIEW</p> <p>1: VIN 2: GND 3: EN 4: NC 5: VOUT</p> 	
<p>SOT89-5(X5) TOP VIEW</p> <p>1: VIN 2: GND 3: EN 4: NC 5: VOUT</p> 	
<p>DFN 6L 2x2 TOP VIEW</p> <p>1: EN 2: GND 3: VIN 4: VOUT 5: NC 6: BP</p> 	
<p>SC70-5 TOP VIEW</p> <p>1: VIN 2: GND 3: EN 4: BP 5: VOUT</p> 	

Example: AIC1747-18GV5TR

→ 1.8V Version, in SOT-23-5 Green

Package & Tape & Reel Packing Type

ORDERING INFORMATION (Continued)
●Marking

Part No	Package Type	Marking
AIC1747-xxGJ3	SC70-3	Axx
AIC1747-xxGJ5	SC70-5	Bxx
AIC1747-xxGDA	DFN 6L 2x2	FAxxG
AIC1747-xxPK3	TSOT-23	FCxxP
AIC1747-xxGK3	TSOT-23	FCxxG
AIC1747-xxPK5	TSOT-25	FDxxP
AIC1747-xxGK5	TSOT-25	FDxxG
AIC1747-xxPK5N	TSOT-25	FZxxP
AIC1747-xxGK5N	TSOT-25	FZxxG
AIC1747-xxPU3	SOT-23	FExxP
AIC1747-xxGU3	SOT-23	FExxG
AIC1747-xxPV5	SOT-25	FFxxP
AIC1747-xxGV5	SOT-25	FFxxG
AIC1747-xxPV5N	SOT-25	FVxxP
AIC1747-xxGV5N	SOT-25	FVxxG
AIC1747-xxPX3A	SOT-89-3	FGxxP
AIC1747-xxGX3A	SOT-89-3	FGxxG
AIC1747-xxPX3T	SOT-89-3	FHxxP
AIC1747-xxGX3T	SOT-89-3	FHxxG
AIC1747-xxPX5	SOT-89-5	FIxxP

Part No	Package Type	Marking
AIC1747-285GJ3	SC70-3	A2J
AIC1747-285GJ5	SC70-5	B2J
AIC1747-285GDA	DFN 6L 2x2	FA2JG
AIC1747-285PK3	TSOT-23	FC2JP
AIC1747-285GK3	TSOT-23	FC2JG
AIC1747-285PK5	TSOT-25	FD2JP
AIC1747-285GK5	TSOT-25	FD2JG
AIC1747-285PK5N	TSOT-25	FZ2JP
AIC1747-285GK5N	TSOT-25	FZ2JG
AIC1747-285PU3	SOT-23	FE2JP
AIC1747-285GU3	SOT-23	FE2JG
AIC1747-285PV5	SOT-25	FF2JP
AIC1747-285GV5	SOT-25	FF2JG
AIC1747-285PV5N	SOT-25	FV2JP
AIC1747-285GV5N	SOT-25	FV2JG
AIC1747-285PX3A	SOT-89-3	FG2JP
AIC1747-285GX3A	SOT-89-3	FG2JG
AIC1747-285PX3T	SOT-89-3	FH2JP
AIC1747-285GX3T	SOT-89-3	FH2JG
AIC1747-285PX5	SOT-89-5	FI2JP

xx represents output voltage. (11=1.1V, 12=1.2V,, 42=4.2V)

■ **ABSOLUTE MAXIMUM RATINGS**

Input Voltage	7V
EN Pin Voltage	7V
Noise Bypass Terminal Voltage	7V
Power Dissipation, P_D @ $T_A = 25^\circ\text{C}$	
SOT23-5	400mW
TSOT23-5	400mW
SOT-89-5	625mW
SC70-5.....	300mW
DFN 6L 2x2	606mW
Maximum Junction Temperature.....	150°C
Operating Temperature Range	-40°C~85°C
Storage Temperature Range	-65°C~150°C
Lead Temperature (Soldering, 10 sec)	260°C
Thermal Resistance - Junction to Case, $R_{\theta_{JC}}$	
SOT-23-5	115° C /W
TSOT23-5	115° C /W
SOT-89-5	45° C /W
DFN 6L 2x2	30° C /W
Thermal Resistance - Junction to Ambient, $R_{\theta_{JA}}$	
SOT-23-5	250° C /W
TSOT23-5	250° C /W
SOT-89-5	160° C /W
SC70-5.....	333° C /W
DFN 6L 2x2	165° C /W

(Assume no ambient airflow, no heatsink)

Absolute Maximum Ratings are those values beyond which the life of a device may be impaired.

■ **TEST CIRCUIT**

Refer to the TYPICAL APPLICATION CIRCUIT.

ELECTRICAL CHARACTERISTICS
($C_{IN} = C_{OUT} = 1\mu F$, $C_{BP} = 0.1nF$, $V_{IN} = V_{OUT} + 1V$, $T_J = 25^\circ C$, unless otherwise specified) (Note 1)

PARAMETER	TEST CONDITIONS	SYMBOL	MIN.	TYP.	MAX.	UNIT
Input Voltage (Note 2)		V_{IN}	2		6	V
Output Voltage Tolerance	$V_{IN} = 6V$, $I_{OUT} = 1mA$	V_{OUT}	-2		2	%
Continuous Output Current		I_{OUT}	300			mA
Quiescent Current	$V_{EN} \geq 1.2V$, $I_{OUT} = 0mA$	I_Q		80	110	μA
GND Pin Current	$I_{OUT} = 300mA$	I_{GND}		80		μA
Standby Current	$V_{EN} = 0$	I_{STBY}		0.01	0.5	μA
Output Current Limit	$V_{IN} = 5V$, $R_{LOAD} = 1\Omega$	I_{IL}	330	450	600	mA
Dropout Voltage	$I_{OUT} = 300mA$, $V_{OUT} = 1.2V$	V_{DROP}		750	1000	mV
	$I_{OUT} = 300mA$, $V_{OUT} = 1.8V$			450	670	
	$I_{OUT} = 300mA$, $V_{OUT} = 3.3V$			270	440	
Line Regulation	$V_{IN} = V_{OUT} + 1V$ to 6V	ΔV_{LIR}		3	10	mV
Load Regulation	$I_{OUT} = 1mA$ to 300mA	ΔV_{LOR}		5	20	mV
Ripple Rejection	$f = 1KHz$, Ripple = 0.5Vp-p,	PSRR		-60		dB
	$f = 10KHz$, Ripple = 0.5Vp-p,			-55		
Temperature Coefficient		TC		50		ppm/ $^\circ C$
Thermal Shutdown Temperature	$V_{IN} = V_{OUT} + 1V$	T_{SD}		150		$^\circ C$
Thermal Shutdown Hysteresis		ΔT_{SD}		20		$^\circ C$
Enable Pin SPECIFICATION						
Enable Pin Current	$V_{EN} = V_{IN}$ or GND	I_{EN}		0	100	nA
Shutdown Exit Delay Time	$I_{OUT} = 30mA$	Δt		50		μS
Max Output Discharge Resistance to GND during Shutdown		$RDSON_{CLMP}$			700	Ω
Shutdown Time				30		μS
Enable Pin Input Threshold	Output ON, $V_{IN} = 2V$ to 6V	V_{ENH}	1.2			V
	Output OFF, $V_{IN} = 2V$ to 6V	V_{ENL}			0.4	

Note 1. Specifications are production tested at $T_A = 25^\circ C$. Specifications over the $-40^\circ C$ to $85^\circ C$ operating temperature range are assured by design, characterization and correlation with Statistical Quality Controls (SQC).

Note 2. $V_{in(min)}$ is the higher value of $V_{out} + \text{Dropout Voltage}$ or 2.0V.

TYPICAL PERFORMANCE CHARACTERISTICS

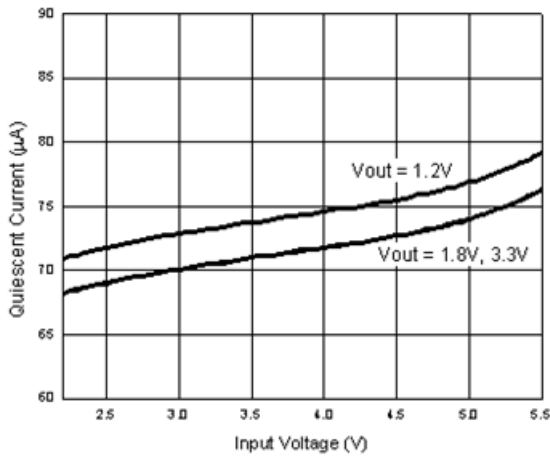

Fig. 1 Quiescent Current VS Input Voltage

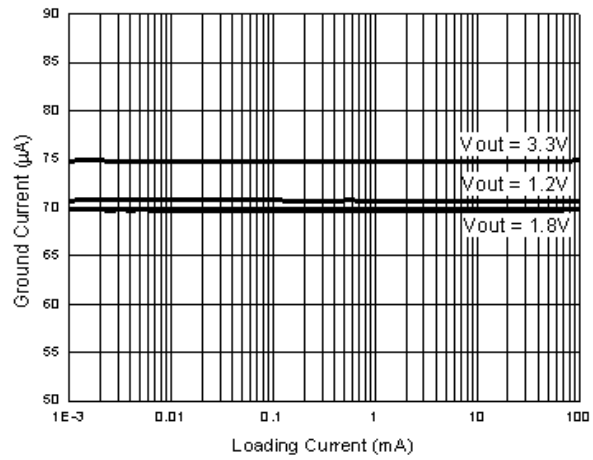

Fig. 2 Ground Current VS Loading Current

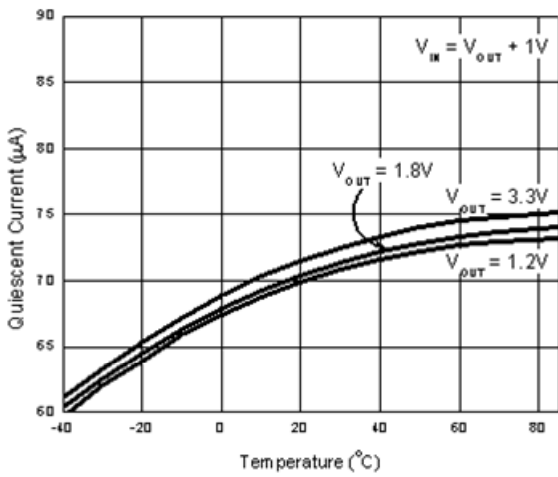

Fig. 3 Quiescent Current VS Temperature

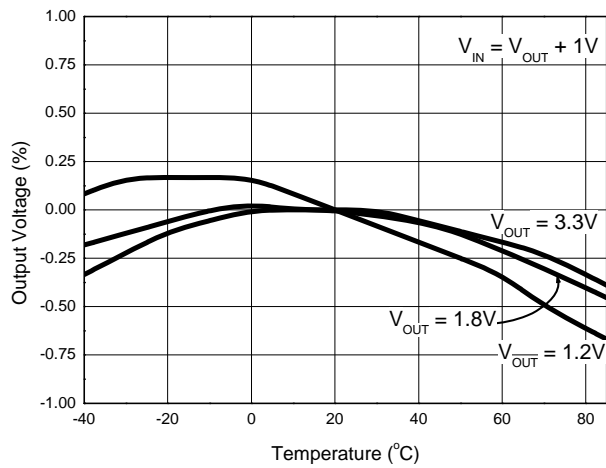

Fig. 4 Output Voltage VS Temperature

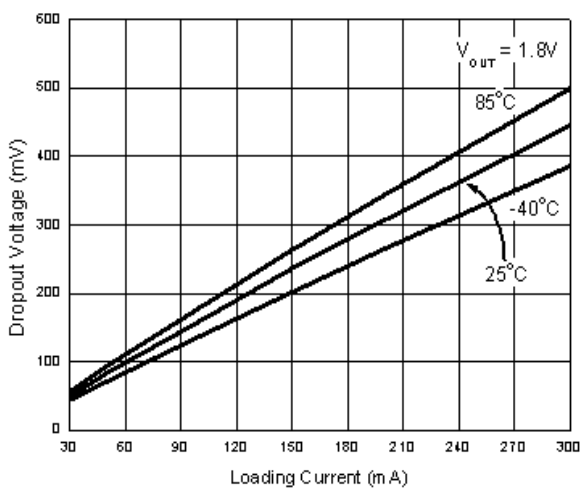

Fig.5 Dropout Voltage VS Loading Current (1.8V)

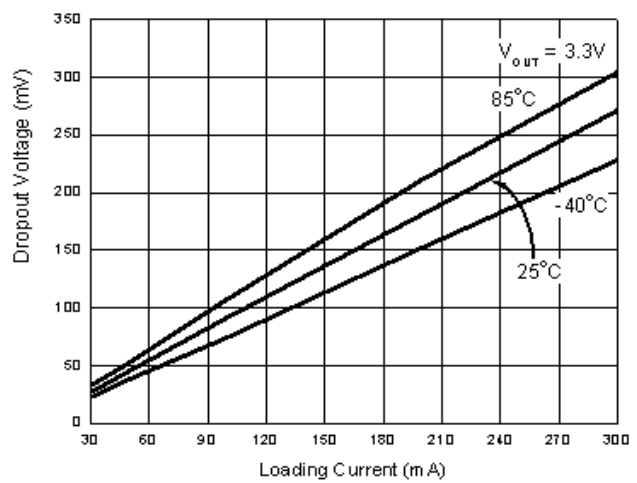

Fig.6 Dropout Voltage VS Loading Current (3.3V)

TYPICAL PERFORMANCE CHARACTERISTICS (Continued)

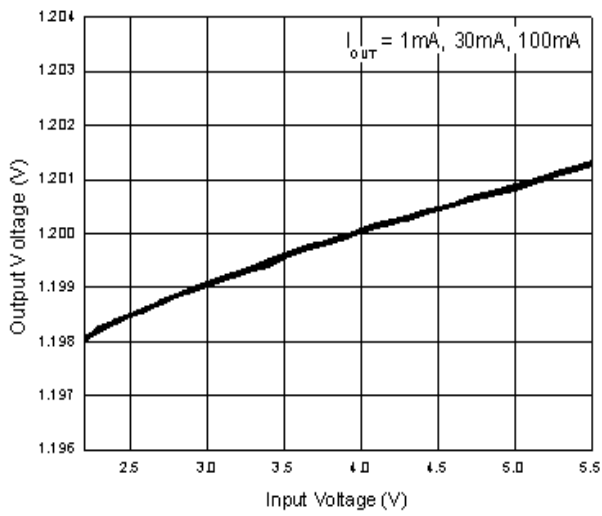

Fig. 7 Output Voltage VS Input Voltage (1.2V)

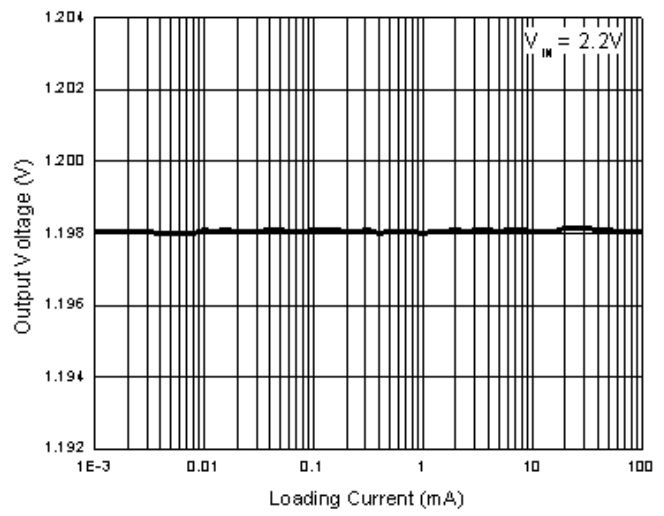

Fig. 8 Output Voltage VS Loading Current (1.2V)

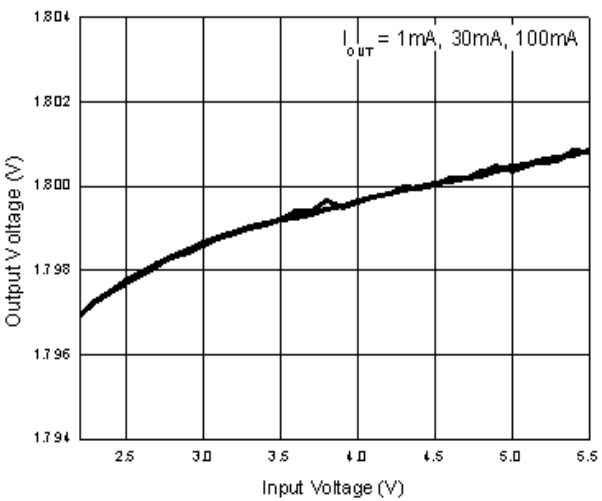

Fig.9 Output Voltage VS Input Voltage (1.8V)

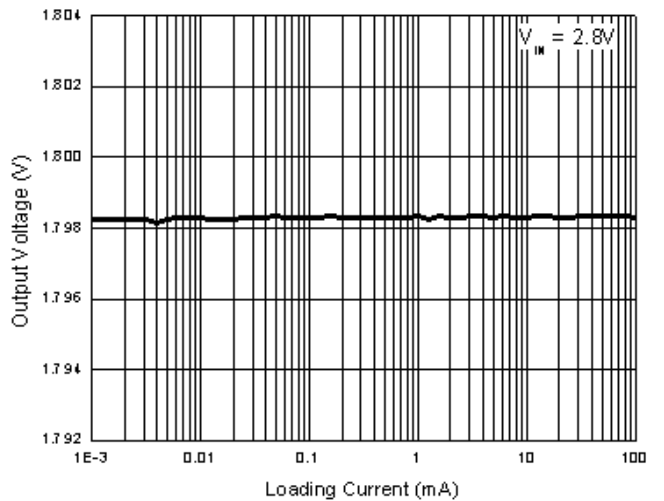

Fig.10 Output Voltage VS Loading Current (1.8V)

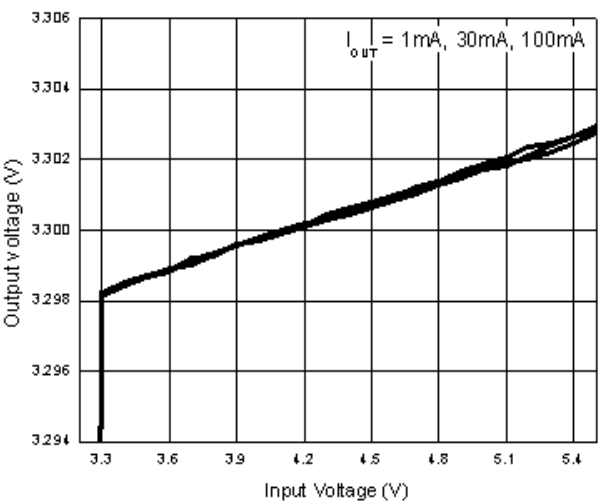

Fig.11 Output Voltage VS Input Voltage (3.3V)

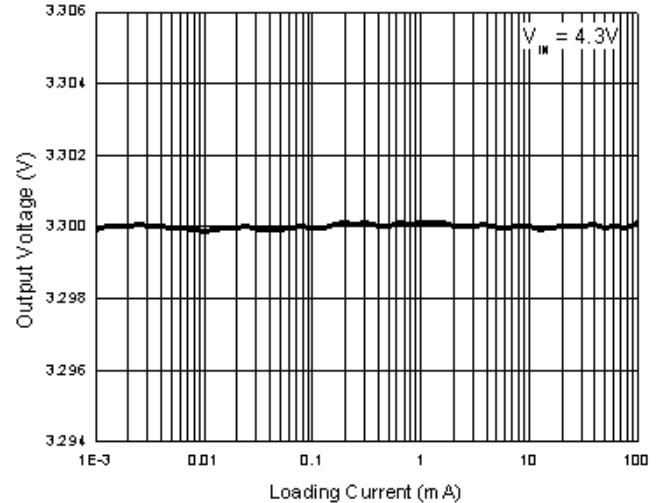

Fig.12 Output Voltage VS Loading Current (3.3V)

TYPICAL PERFORMANCE CHARACTERISTICS (Continued)

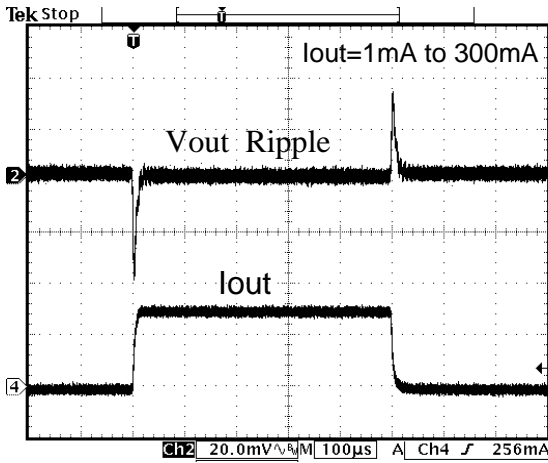

Fig. 13 Load Transient Response (1.2V)

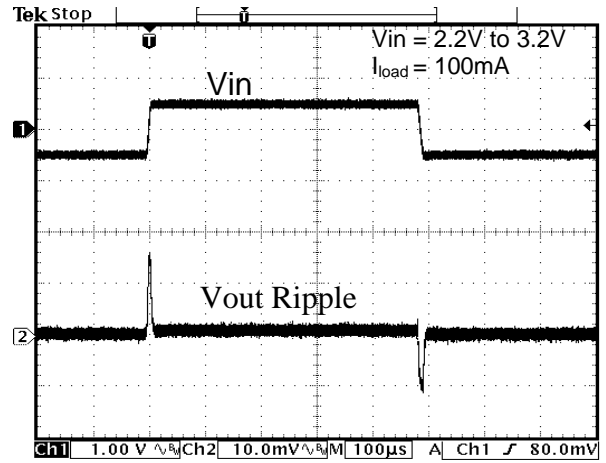

Fig. 14 Line Transient Response (1.2V)

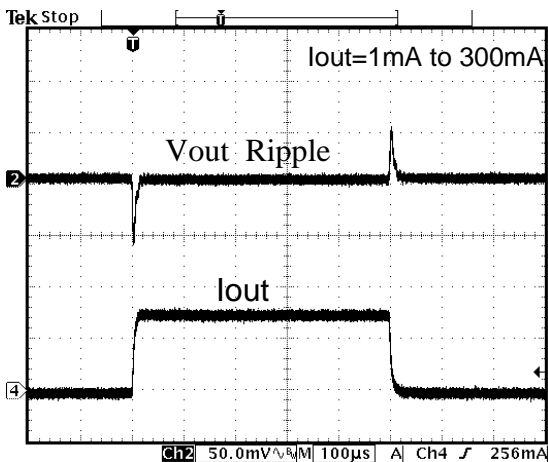

Fig. 15 Load Transient Response (1.8V)

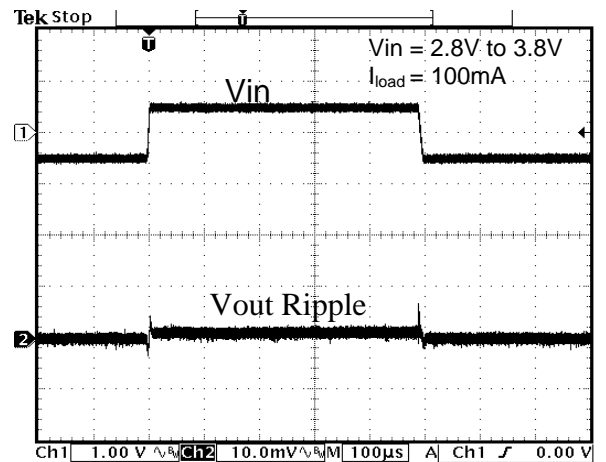

Fig. 16 Line Transient Response (1.8V)

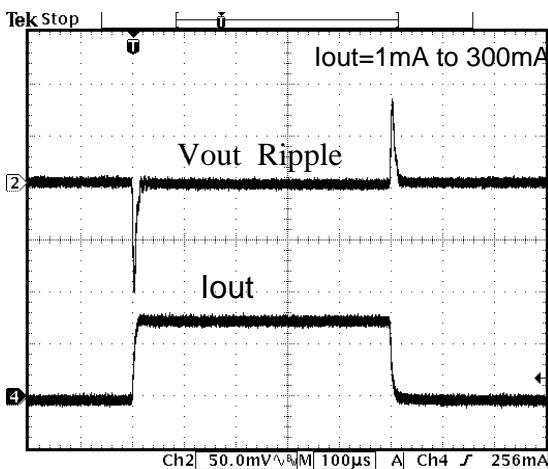

Fig. 17 Load Transient Response (3.3V)

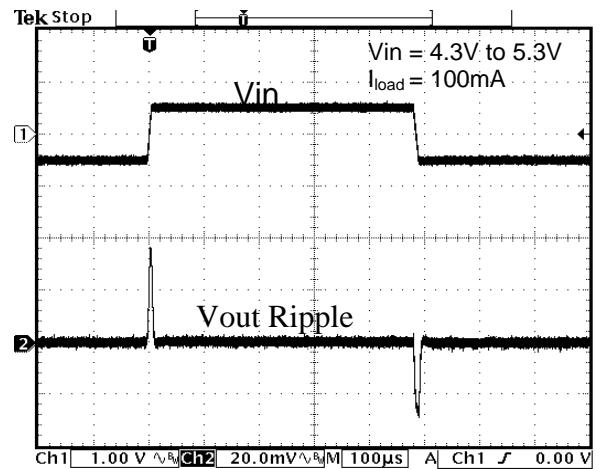

Fig. 18 Line Transient Response (3.3V)

TYPICAL PERFORMANCE CHARACTERISTICS (Continued)

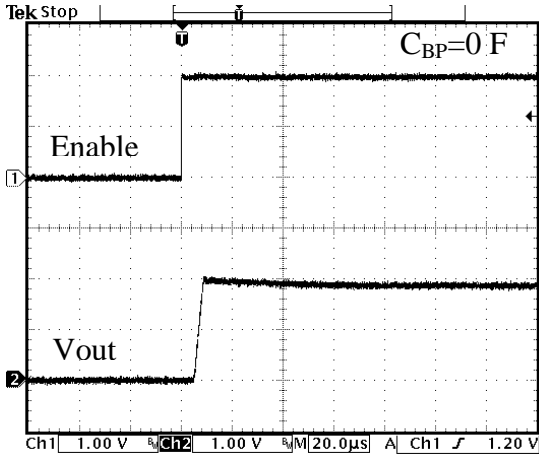

Fig. 19 Start-up Waveform

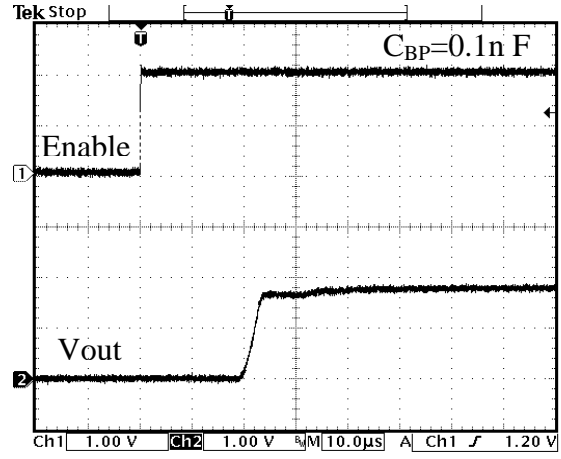

Fig. 20 Start-up Waveform

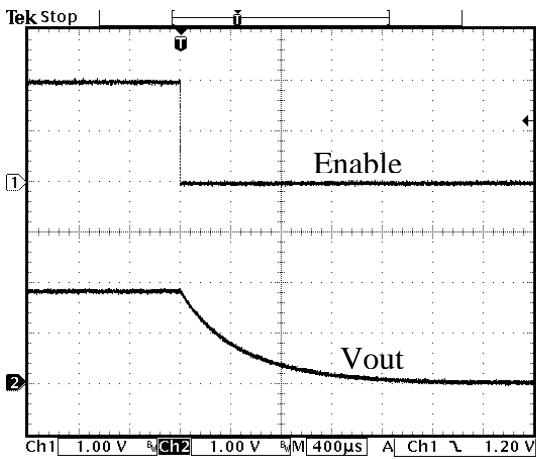
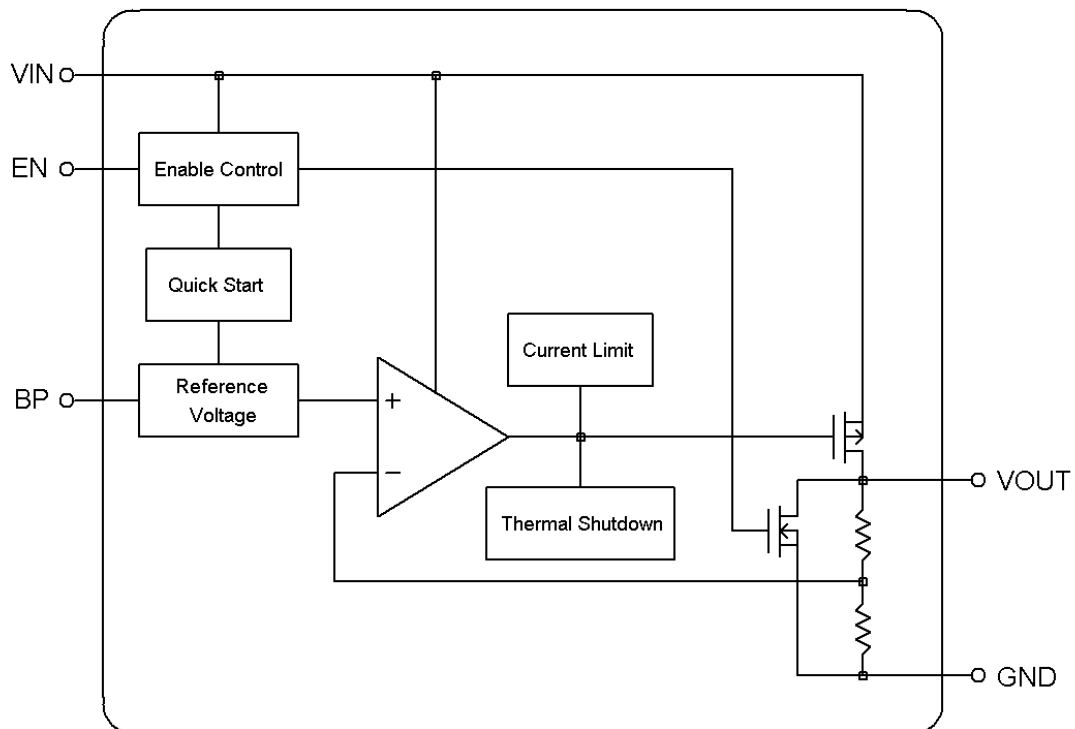

Fig. 21 Shutdown Waveform

■ BLOCK DIAGRAM

■ PIN DESCRIPTION

VIN - Power supply input pin. Bypass with a 1 μ F capacitor to GND

GND - Ground.

EN - Active High Enable Input.

VOUT - Regulator Output pin. Sources up to 300 mA.

BP - Bypass pin. It should be connected to external 0.1nF capacitor to GND to reduce output noise.

■ DETAILED DESCRIPTION OF TECHNICAL TERMS

DROPOUT VOLTAGE (V_{DROP})

The dropout voltage is defined as the difference between input voltage and output voltage at which point the regulator starts to fall out of regulation. Below this value, the output voltage will fall while the input voltage is reduced. It depends on the load current and junction temperature. The dropout voltage is specified at which the output voltage drops 100mV below the value measured with 1V difference.

LINE REGULATION

Line regulation is the ability of the regulator to maintain a constant output voltage as the input voltage changes. The line regulation is specified as the input voltage is changed from $V_{IN} = V_{OUT} + 1\text{ V}$ to 6 V and $I_{OUT} = 1\text{ mA}$.

LOAD REGULATION

Load regulation is the ability of the regulator to maintain a constant output voltage as the load current changes. To minimize temperature

effects, it is a pulsed measurement with the input voltage set to $V_{IN} = V_{OUT} + 1\text{ V}$. The load regulation is specified under the output current step of 0.1mA to 300mA.

CURRENT LIMIT (I_{IL})

The AIC1747 includes a current limiting, which monitors and controls the maximum output current if the output is shorted to ground. This can protect the device from being damaged.

THERMAL PROTECTION

The thermal sensor protects the device when the junction temperature exceeds $T_J = +150^\circ\text{C}$. It signals, the shutdown logic, turning off the pass transistor and allowing the IC to cool. Thermal protection is designed to protect the device in the event of fault conditions. For continuous operation do not exceed the absolute maximum junction-temperature rating of $T_J = 150^\circ\text{C}$, or damage the device.

■ APPLICATION INFORMATION

INPUT-OUTPUT CAPACITORS

Linear regulators require input and output capacitors to maintain stability. Input capacitor at 1 μ F with 1 μ F output capacitor is recommended.

POWER DISSIPATION

The AIC1747 obtains thermal-limiting circuitry, which is designed to protect the device against overload condition. For continuous load condition, maximum rating of junction temperature must not be exceeded. It is important to pay more attention in thermal resistance. It includes junction to case, junction to ambient. The maximum power dissipation of AIC1747 depends on the thermal resistance of its case and circuit board, the temperature difference between the die junction and ambient air, and the rate of airflow. The rate of temperature rise is greatly affected by the mounting pad configuration on the PCB, the board material, and the ambient temperature. When the IC mounting with good thermal

conductivity is used, the junction temperature will be low even when large power dissipation applies.

The power dissipation across the device is

$$P = I_{OUT} (V_{IN} - V_{OUT}).$$

The maximum power dissipation is:

$$P_{MAX} = \frac{(T_{J-max} - T_A)}{R\theta_{JA}}$$

Where T_{J-max} is the maximum allowable junction temperature (150°C), and T_A is the ambient temperature suitable in application.

As a general rule, the lower temperature is, the better reliability of the device is. So the PCB mounting pad should provide maximum thermal conductivity to maintain low device temperature. GND pin performs a dual function for providing an electrical connection to ground and channeling heat away. Therefore, connecting the GND pin to ground with a large pad or ground plane would increase the power dissipation and reduce the device temperature.

■ PHYSICAL DIMENSIONS

● SOT-89 PACKAGE OUTLINE DRAWING

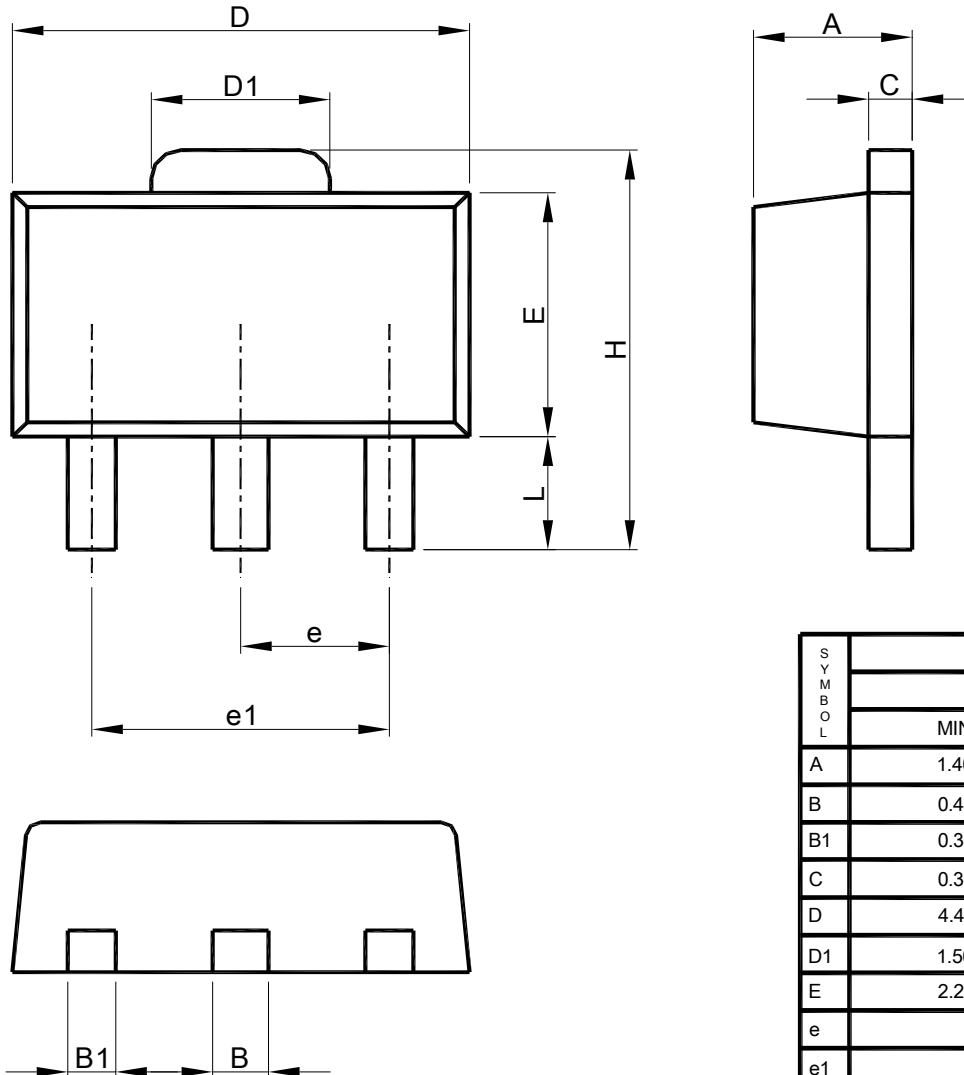

SYMBOL	SOT-89	
	MILLIMETERS	
	MIN.	MAX.
A	1.40	1.60
B	0.44	0.56
B1	0.36	0.48
C	0.35	0.44
D	4.40	4.60
D1	1.50	1.83
E	2.29	2.60
e	1.50 BSC	
e1	3.00 BSC	
H	3.94	4.25
L	0.89	1.20

- Note: 1. Refer to JEDEC TO-243AA.
 2. Dimension "D" does not include mold flash, protrusions or gate burrs. Mold flash, protrusion or gate burrs shall not exceed 6 mil per side.
 3. Dimension "E" does not include inter-lead flash or protrusions.
 4. Controlling dimension is millimeter, converted inch dimensions are not necessarily exact.

● SOT-89- 5PIN PACKAGE OUTLINE DRAWING

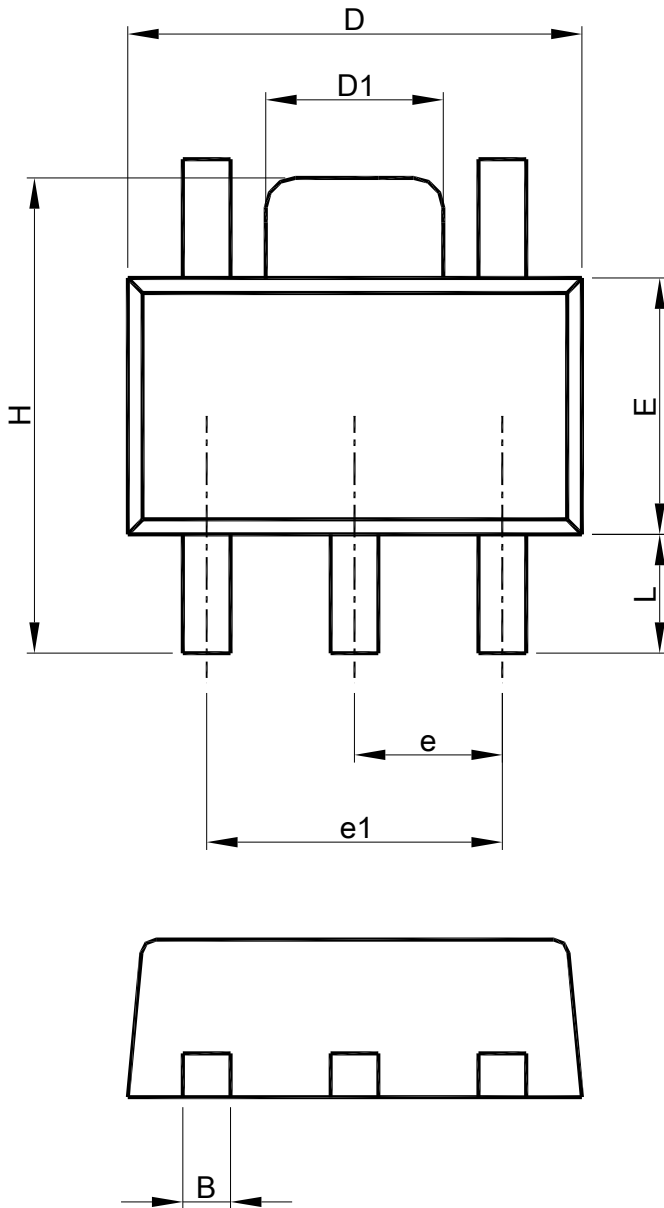

SYMBOL	SOT-89-5	
	MILLIMETERS	
	MIN.	MAX.
A	1.40	1.60
B	0.36	0.56
C	0.35	0.44
D	4.40	4.60
D1	1.50	1.83
E	2.29	2.60
e	1.50 BSC	
e1	3.00 BSC	
H	3.94	4.25
L	0.80	1.20

- Note: 1. Refer to JEDEC TO-243AA.
 2. Dimension "D" does not include mold flash, protrusions or gate burrs. Mold flash, protrusion or gate burrs shall not exceed 6 mil per side.
 3. Dimension "E" does not include inter-lead flash or protrusions.
 4. Controlling dimension is millimeter, converted inch dimensions are not necessarily exact.

● TSOT23 PACKAGE OUTLINE DRAWING

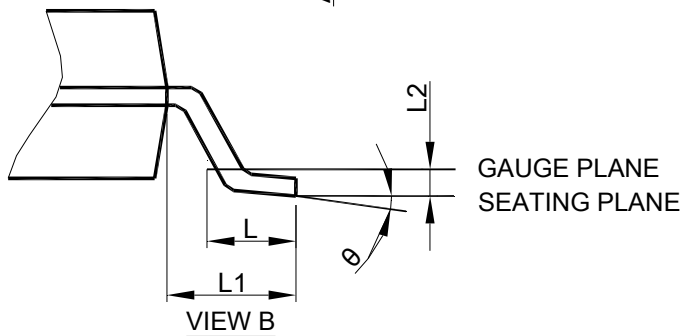
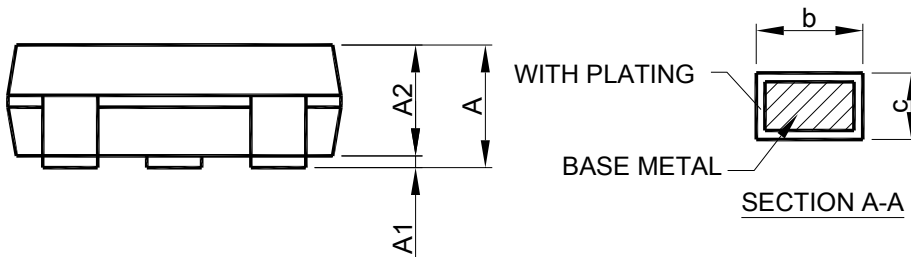
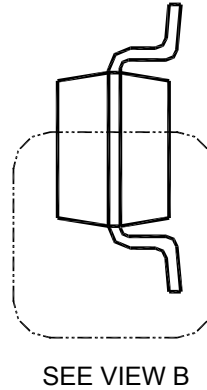
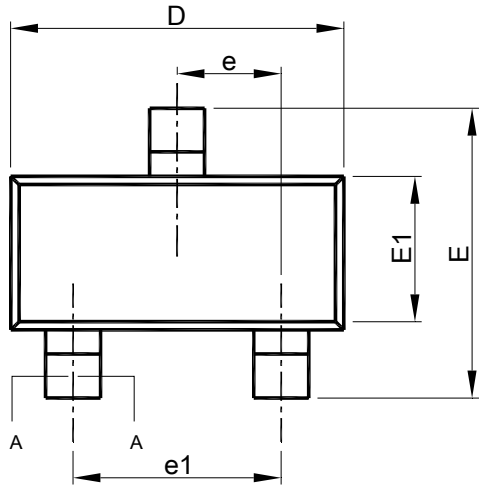

SYMBOL	TSOT-23	
	MILLIMETERS	
	MIN.	MAX.
A	-	1.00
A1	0	0.10
A2	0.70	0.90
b	0.30	0.50
c	0.08	0.22
D	2.80	3.00
E	2.60	3.00
E1	1.50	1.70
e	0.95 BSC	
e1	1.90 BSC	
L	0.30	0.60
L1	0.60 REF	
L2	0.25 BSC	
θ	0°	8°

- Note :
1. Refer to JEDEC MO-193C.
 2. Dimension "D" does not include mold flash, protrusions or gate burrs. Mold flash, protrusion or gate burrs shall not exceed 6 mil per side.
 3. Dimension "E1" does not include inter-lead flash or protrusions.
 4. Controlling dimension is millimeter, converted inch dimensions are not necessarily exact.

● TSOT23- 5PIN PACKAGE OUTLINE DRAWING

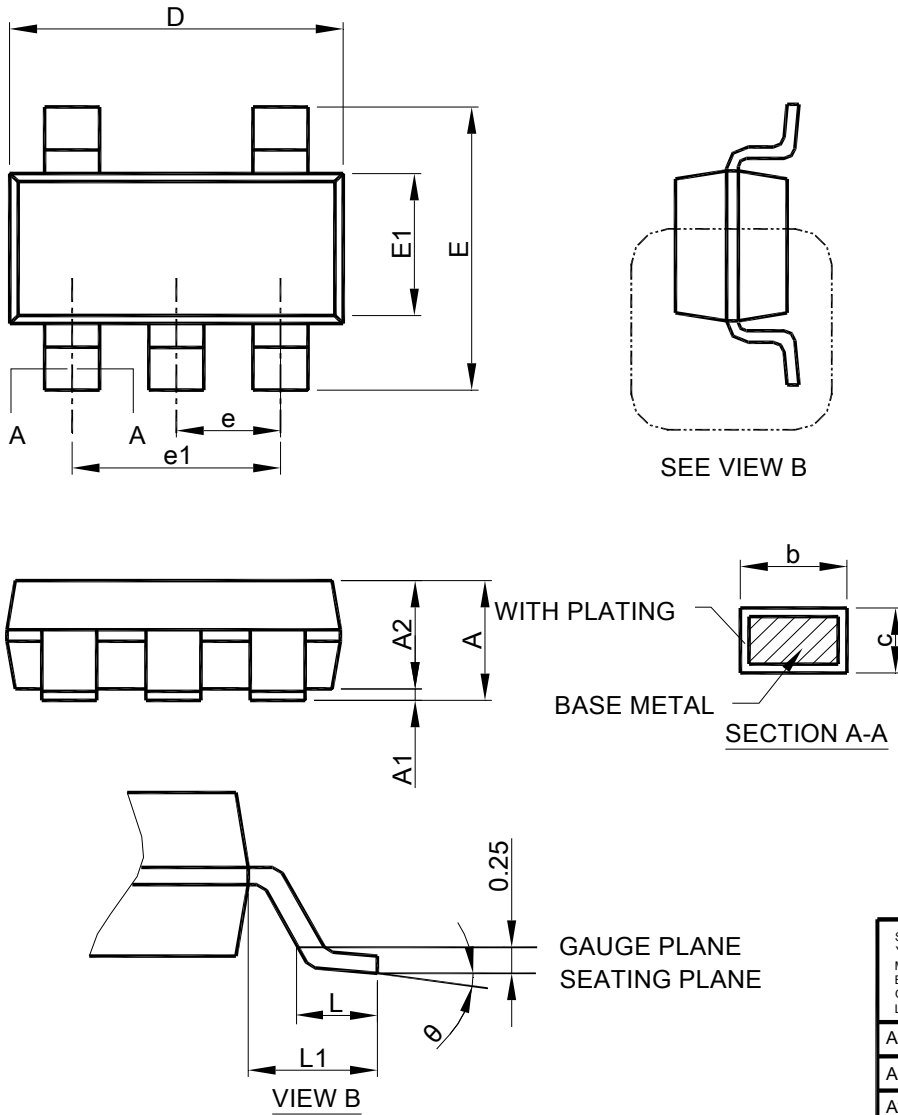

- Note : 1. Refer to JEDEC MO-193AB.
 2. Dimension "D" does not include mold flash, protrusions or gate burrs. Mold flash, protrusion or gate burrs shall not exceed 6 mil per side.
 3. Dimension "E1" does not include inter-lead flash or protrusions.
 4. Controlling dimension is millimeter, converted inch dimensions are not necessarily exact.

SYMBOL	TSOT-23-5	
	MILLIMETERS	
	MIN.	MAX.
A	-	1.00
A1	0	0.10
A2	0.70	0.90
b	0.30	0.50
c	0.08	0.22
D	2.80	3.00
E	2.60	3.00
E1	1.50	1.70
e	0.95 BSC	
e1	1.90 BSC	
L	0.30	0.60
L1	0.60 REF	
θ	0°	8°

● SOT-23 PACKAGE OUTLINE DRAWING

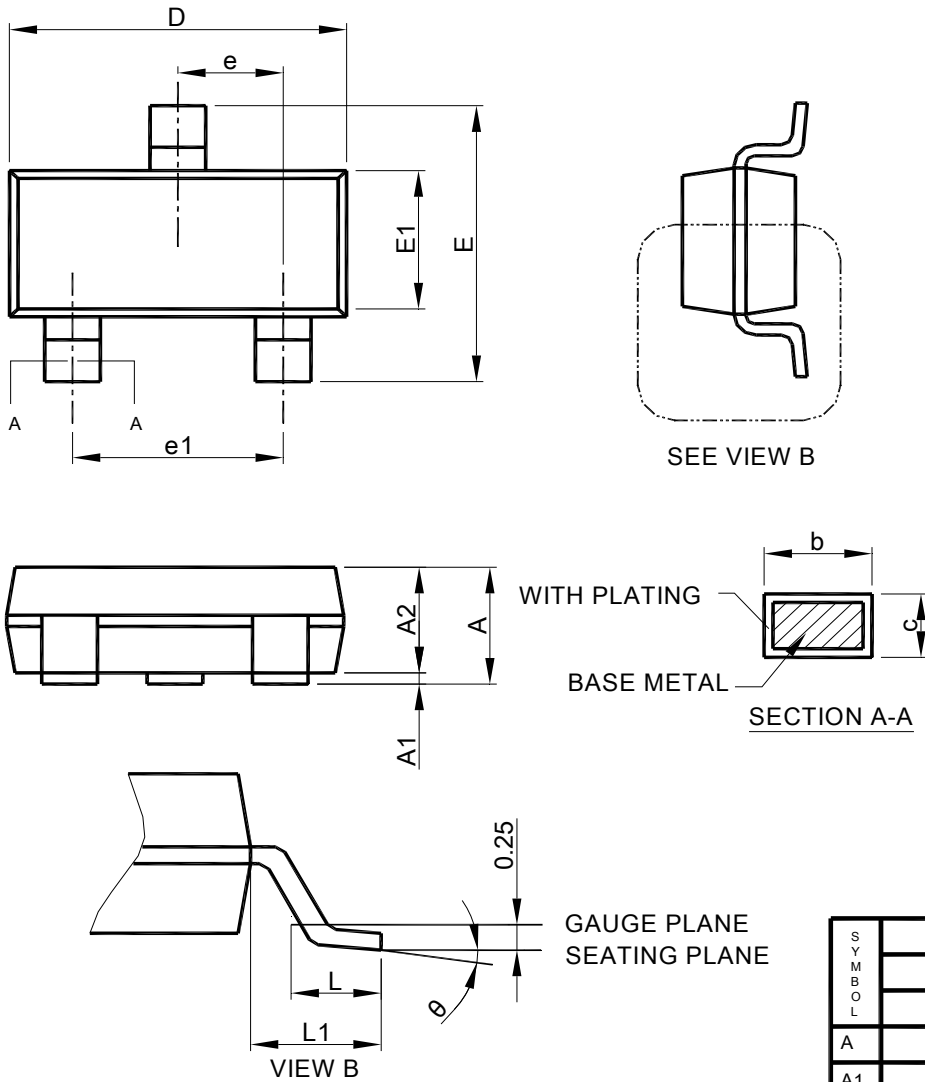

- Note: 1. Refer to JEDEC MO-178.
 2. Dimension "D" does not include mold flash, protrusions or gate burrs. Mold flash, protrusion or gate burrs shall not exceed 10 mil per side.
 3. Dimension "E1" does not include inter-lead flash or protrusions.
 4. Controlling dimension is millimeter, converted inch dimensions are not necessarily exact.

SYMBOL	SOT-23	
	MILLIMETERS	
	MIN.	MAX.
A	0.95	1.45
A1	0.00	0.15
A2	0.90	1.30
b	0.30	0.50
c	0.08	0.22
D	2.80	3.00
E	2.60	3.00
E1	1.50	1.70
e	0.95 BSC	
e1	1.90 BSC	
L	0.30	0.60
L1	0.60 REF	
θ	0°	8°

● SOT-23- 5PIN PACKAGE OUTLINE DRAWING

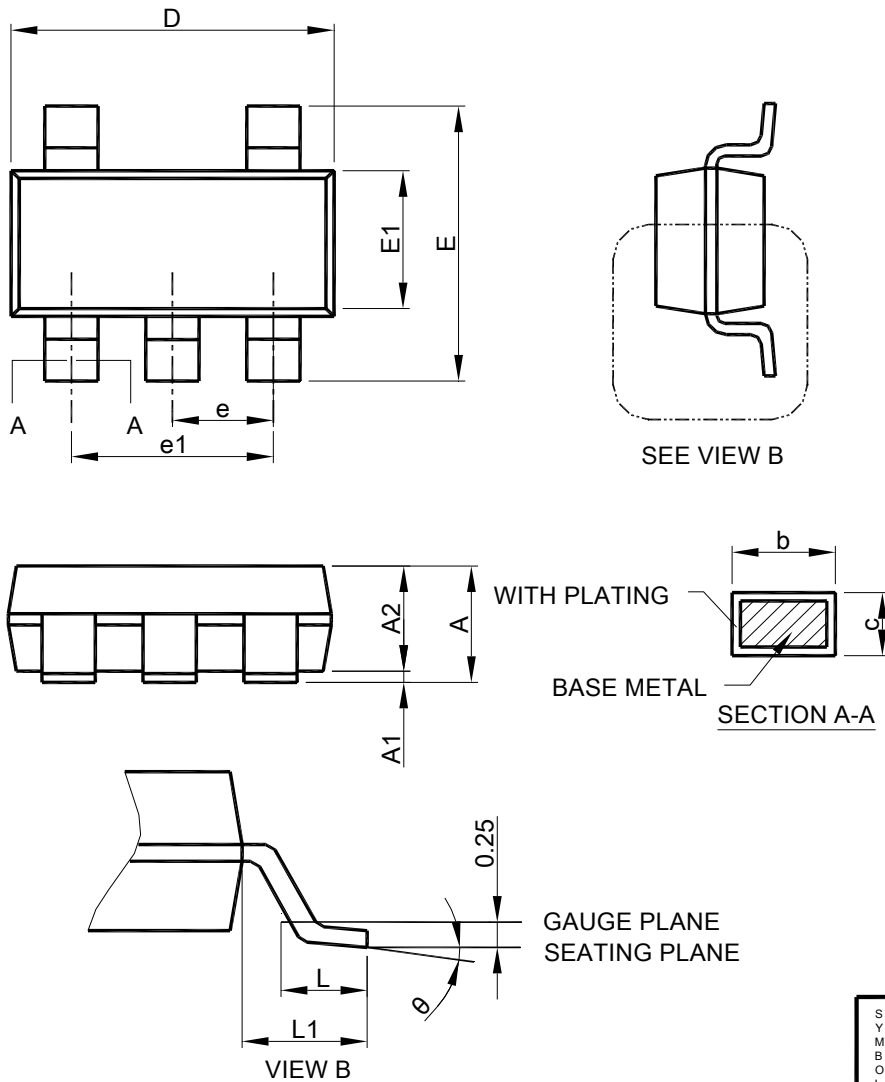

- Note :
1. Refer to JEDEC MO-178AA.
 2. Dimension "D" does not include mold flash, protrusions or gate burrs. Mold flash, protrusion or gate burrs shall not exceed 10 mil per side.
 3. Dimension "E1" does not include inter-lead flash or protrusions.
 4. Controlling dimension is millimeter, converted inch dimensions are not necessarily exact.

SYMBOL	SOT-23-5	
	MILLIMETERS	
	MIN.	MAX.
A	0.95	1.45
A1	0.00	0.15
A2	0.90	1.30
b	0.30	0.50
c	0.08	0.22
D	2.80	3.00
E	2.60	3.00
E1	1.50	1.70
e	0.95 BSC	
e1	1.90 BSC	
L	0.30	0.60
L1	0.60 REF	
θ	0°	8°

● SC70-3PIN PACKAGE OUTLINE DRAWING

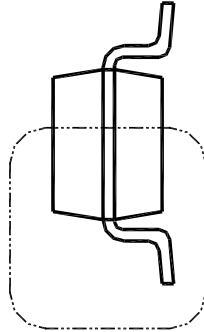
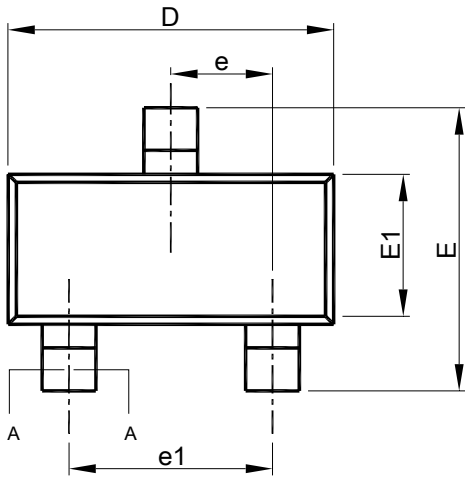

SEE VIEW B

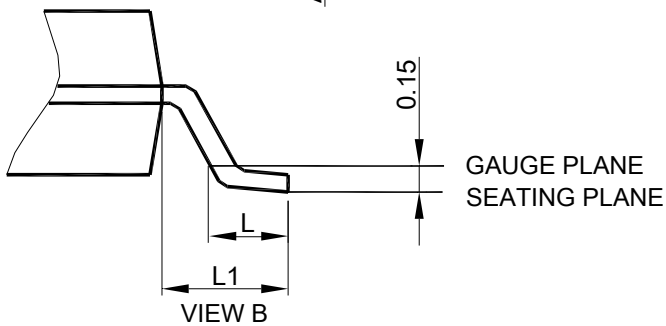
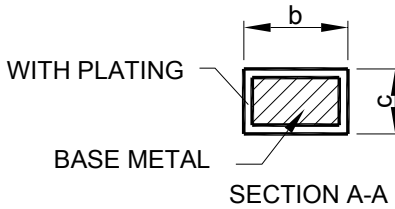
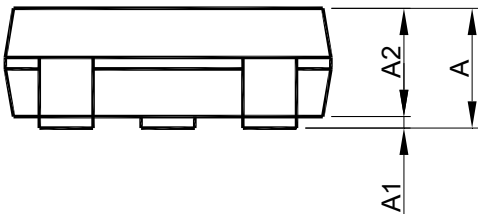

- Note: 1. Refer to JEDEC MO-203.
 2. Dimension "D" does not include mold flash, protrusions or gate burrs. Mold flash, protrusion or gate burrs shall not exceed 6 mil per side.
 3. Dimension "E1" does not include inter-lead flash or protrusions.
 4. Controlling dimension is millimeter, converted inch dimensions are not necessarily exact.

SYMBOL	SC70-3L	
	MILLIMETERS	
	MIN.	MAX.
A	-	1.10
A1	0	0.10
A2	0.70	1.00
b	0.15	0.40
c	0.08	0.25
D	1.85	2.15
E	1.80	2.40
E1	1.10	1.40
e	0.65 BSC	
e1	1.30 BSC	
L	0.26	0.46
L1	0.42 REF	

● SC70 - 5PIN PACKAGE OUTLINE DRAWING

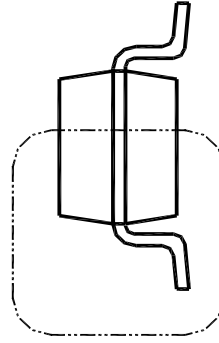
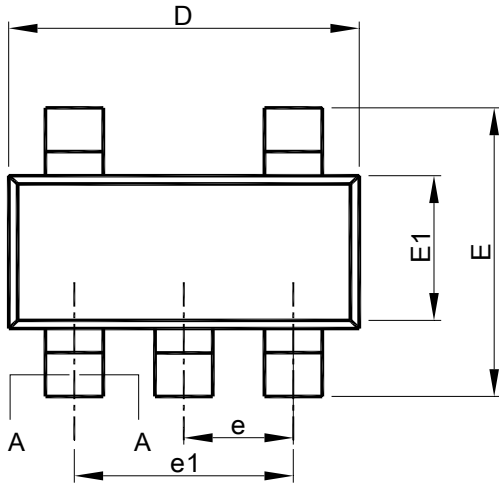

SEE VIEW B

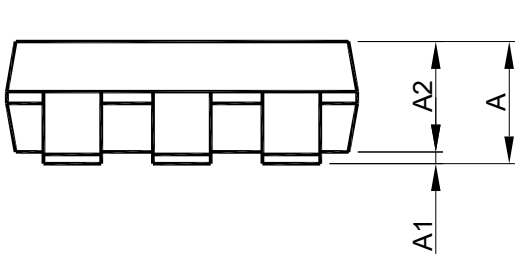

WITH PLATING

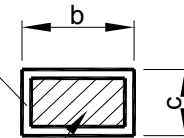

BASE METAL

SECTION A-A

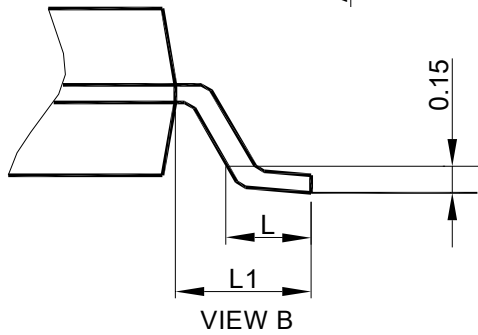

GAUGE PLANE
SEATING PLANE

VIEW B

- Note: 1. Refer to JEDEC MO-203AA.
 2. Dimension "D" does not include mold flash, protrusions or gate burrs. Mold flash, protrusion or gate burrs shall not exceed 6 mil per side.
 3. Dimension "E1" does not include inter-lead flash or protrusions.
 4. Controlling dimension is millimeter, converted inch dimensions are not necessarily exact.

SYMBOL	SC70-5L	
	MILLIMETERS	
	MIN.	MAX.
A	-	1.10
A1	0	0.10
A2	0.70	1.00
b	0.15	0.30
c	0.08	0.25
D	1.85	2.15
E	1.80	2.40
E1	1.10	1.40
e	0.65 BSC	
e1	1.30 BSC	
L	0.26	0.46
L1	0.42 REF	

● DFN 6L 2x2 PACKAGE OUTLINE DRAWING

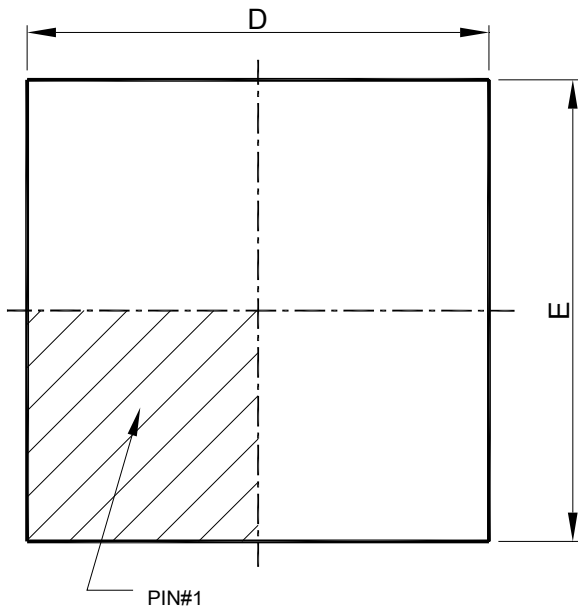

TOP VIEW

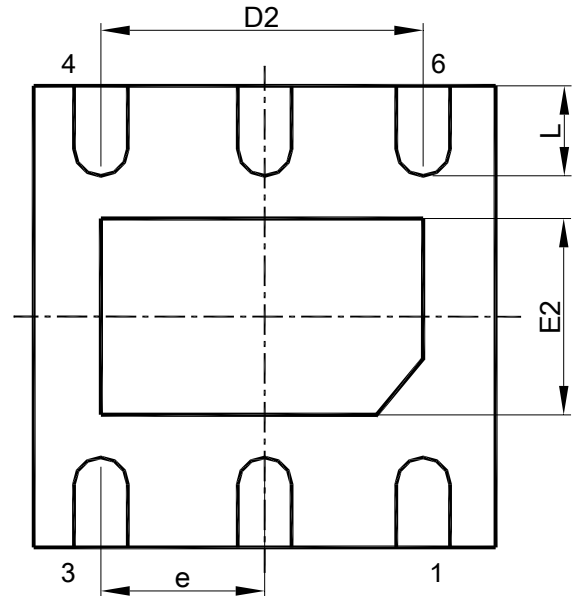

BOTTOM VIEW

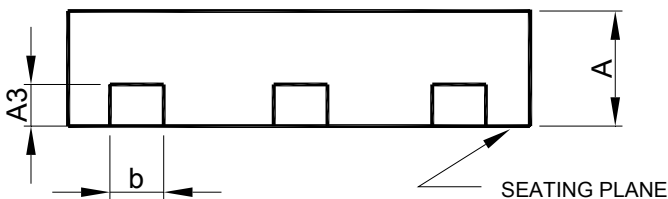

SIDE VIEW

SYMBOL	DFN 6L-2x2x0.75-0.65mm	
	MILLIMETERS	
	MIN.	MAX.
A	0.70	0.80
A3	0.20 BSC	
b	0.25	0.35
D	2.00 BSC	
D2	1.20	1.60
E	2.00 BSC	
E2	0.55	0.85
e	0.65 BSC	
L	0.25	0.45

- Note :
1. DIMENSION AND TOLERANCING CONFORM TO ASME Y14.5M-1994.
 2. CONTROLLING DIMENSIONS : MILLIMETER , CONVERTED INCH DIMENSION ARE NOT NECESSARILY EXACT.
 3. DIMENSION b APPLIES TO METALLIZED TERMINAL AND IS MEASURED BETWEEN 0.10 AND 0.25 mm FROM TERMINAL TIP.

Note:

Information provided by AIC is believed to be accurate and reliable. However, we cannot assume responsibility for use of any circuitry other than circuitry entirely embodied in an AIC product; nor for any infringement of patents or other rights of third parties that may result from its use. We reserve the right to change the circuitry and specifications without notice.

Life Support Policy: AIC does not authorize any AIC product for use in life support devices and/or systems. Life support devices or systems are devices or systems which, (i) are intended for surgical implant into the body or (ii) support or sustain life, and whose failure to perform, when properly used in accordance with instructions for use provided in the labeling, can be reasonably expected to result in a significant injury to the user.

X-ON Electronics

Largest Supplier of Electrical and Electronic Components

Click to view similar products for [Linear Voltage Regulators](#) category:

Click to view products by [AIC](#) manufacturer:

Other Similar products are found below :

[LV56831P-E](#) [LV5684PVD-XH](#) [MCDTSA6-2R](#) [L7815ACV-DG](#) [PQ3DZ53U](#) [LV56801P-E](#) [TLE42794G](#) [L78L05CZ/1SX](#) [L78LR05DL-MA-E](#) [636416C](#) [714954EB](#) [BA033LBSG2-TR](#) [LV5680P-E](#) [L78M15CV-DG](#) [TLS202B1MBV33HTSA1](#) [L79M05T-E](#) [TLS202A1MBVHTSA1](#) [L78LR05D-MA-E](#) [NCV317MBTG](#) [NTE7227](#) [LV5680NPVC-XH](#) [LT1054CN8](#) [MP2018GZD-5-Z](#) [MP2018GZD-33-Z](#) [MIC5281-3.3YMM](#) [RT9078-28GQZ](#) [MC78L06BP-AP](#) [TA48LS05F\(TE85L,F\)](#) [TC47BR5003ECT](#) [TCR2LN12,LF\(S](#) [TCR2LN28,LF\(S](#) [TCR2LN30,LF\(S](#) [TCR3DF295,LM\(CT](#) [TCR3DF40,LM\(CT](#) [BA178M20CP-E2](#) [L78M12ABDT](#) [LR645N3-G-P003](#) [LR645N3-G-P013](#) [ZXTR2005P5-13](#) [SCD7812BTG](#) [TCR3DF335,LM\(CT](#) [TLE42994E V33](#) [ZXTR2008K-13](#) [ZXTR2005K-13](#) [L88R05DL-E](#) [ADP3300ARTZ-2.7RL7](#) [LM120K-15/883](#) [IFX54441LDVXUMA1](#) [LM317D2T-TR](#) [LM350T/NOPB](#)