

Part Numbering System



① Category code

| Type | Code | |
|------------------------|------|---|
| | 2 | 3 |
| Electrolytic Capacitor | E | |
| Conductive Polymer | S | |

② Series code

| Series name | Code | |
|-------------|------|---|
| | 2 | 3 |
| WH | W | H |
| CD11GE | G | E |
| CD11GES | G | X |
| CD11GAS | G | W |
| CD11GHS | G | S |
| NR | N | R |
| PZ | P | Z |

③ Voltage code

| WV (V _{dc}) | Code | |
|-----------------------|------|---|
| | 4 | 5 |
| 2.5 | 0 | E |
| 3 | 0 | D |
| 4 | 0 | G |
| 6.3 | 0 | J |
| 6.8 | 0 | C |
| 7 | 0 | Q |
| 7.5 | 0 | A |
| 10 | 1 | A |
| 12 | 1 | T |
| 16 | 1 | C |
| 25 | 1 | E |
| 35 | 1 | V |
| 40 | 1 | G |
| 50 | 1 | H |
| 63 | 1 | J |
| 80 | 1 | B |
| 100 | 1 | K |
| 120 | 2 | B |
| 160 | 2 | C |
| 180 | 2 | L |
| 200 | 2 | D |
| 220 | 2 | N |
| 250 | 2 | E |
| 315 | 2 | F |
| 350 | 2 | V |
| 380 | 2 | P |
| 400 | 2 | G |
| 420 | 2 | T |
| 450 | 2 | W |
| 500 | 2 | H |
| 550 | 2 | J |
| 600 | 2 | K |

④ Capacitance tolerance code

| Tol. (%) | Code | |
|----------|------|--|
| | 6 | |
| -10~+10 | K | |
| -20~+20 | M | |
| -10~+30 | Q | |
| -10~+20 | V | |
| 0~+20 | A | |
| -5~+20 | C | |
| -10~-20 | B | |
| -5~+5 | D | |
| 0~+10 | E | |
| -5~-20 | F | |
| -15~+5 | N | |

⑤ Capacitance code

| Cap (μF) | Code | | |
|----------|------|---|---|
| | 7 | 8 | 9 |
| 0.10 | R | 1 | 0 |
| 0.22 | R | 2 | 2 |
| 0.33 | R | 3 | 3 |
| 0.47 | R | 4 | 7 |
| 0.68 | R | 6 | 8 |
| 1 | 0 | 1 | 0 |
| 2.2 | 2 | R | 2 |
| 3.3 | 3 | R | 3 |
| 4.7 | 4 | R | 7 |
| 6.8 | 6 | R | 8 |
| 10 | 1 | 0 | 0 |
| 22 | 2 | 2 | 0 |
| 33 | 3 | 3 | 0 |
| 47 | 4 | 7 | 0 |
| 68 | 6 | 8 | 0 |
| 100 | 1 | 0 | 1 |
| 220 | 2 | 2 | 1 |
| 330 | 3 | 3 | 1 |
| 470 | 4 | 7 | 1 |
| 680 | 6 | 8 | 1 |
| 1000 | 1 | 0 | 2 |
| 2200 | 2 | 2 | 2 |
| 3300 | 3 | 3 | 2 |
| 4700 | 4 | 7 | 2 |
| 6800 | 6 | 8 | 2 |
| 10000 | 1 | 0 | 3 |
| 22000 | 2 | 2 | 3 |
| 33000 | 3 | 3 | 3 |
| 68000 | 6 | 8 | 3 |

⑥ Size code

| ΦD (mm) | Code |
|---------|------|
| 4 | C |
| 5 | D |
| 6.3 | E |
| 8 | F |
| 10 | G |
| 11 | H |
| 12 | J |
| 12.5 | W |
| 13 | K |
| 14 | X |
| 16 | L |
| 18 | M |
| 19 | Z |
| 20 | N |
| 22 | O |
| 25 | P |
| 30 | Q |
| 35 | R |
| 40 | Y |
| 51.6 | S |
| 64.3 | T |
| 76.9 | U |
| 91 | V |
| 100 | A |

| L (mm) | Code | |
|--------|------|----|
| | 11 | 12 |
| 5 | 0 | 5 |
| 7 | 0 | 7 |
| 11 | 1 | 1 |
| 12 | 1 | 2 |
| 16 | 1 | 6 |
| 20 | 2 | 0 |
| 25 | 2 | 5 |
| 30 | 3 | 0 |
| 35 | 3 | 5 |
| 40 | 4 | 0 |
| 46 | 4 | 6 |
| 50 | 5 | 0 |
| 60 | 6 | 0 |
| 80 | 8 | 0 |
| 100 | A | 0 |
| 115 | B | 5 |
| 120 | C | 0 |
| 130 | D | 0 |
| 140 | E | 0 |
| 160 | G | 0 |
| 200 | K | 0 |
| 220 | M | 0 |
| 236 | N | 6 |
| 250 | P | 0 |

⑦ Terminal code

| Specification | Code | | |
|---------------------------------------|------|----|----|
| | 13 | 14 | 15 |
| Bulk packing | O | - | - |
| Taping (SMD Type) | D | 0 | 0 |
| Φ4~8 Taping F=5.0mm | P | 5 | 0 |
| Φ10~12.5 Taping F=5.0mm | B | 5 | 0 |
| Lead Cut L=3.5mm | C | 3 | 5 |
| Lead Cut L=11.0mm | C | B | 0 |
| Lead Forming & Cut L=4.5mm | F | - | - |
| Kink & Cut L=4.5mm | J | - | - |
| Snap-in type Terminal 4.0mm in length | K | - | - |
| Three Terminals | T | - | - |
| Ring clip mounting standard design | A | 0 | 0 |
| Ring clip mounting special design | S | - | - |

⑧ Sleeve/Marking code

| Sleeve/Marking | Code | |
|----------------|------|--|
| | 16 | |
| PVC | C | |
| PET | T | |
| Dark blue | B | |
| Bright red | R | |
| Sky-blue | S | |
| Light blue | T | |
| Pink | Z | |
| Black | H | |
| Purple-blue | V | |
| Red | O | |

Lead Forming
Taping Specifications

Fig.1 code: X



Fig.2 code: B



Fig.3 code: B

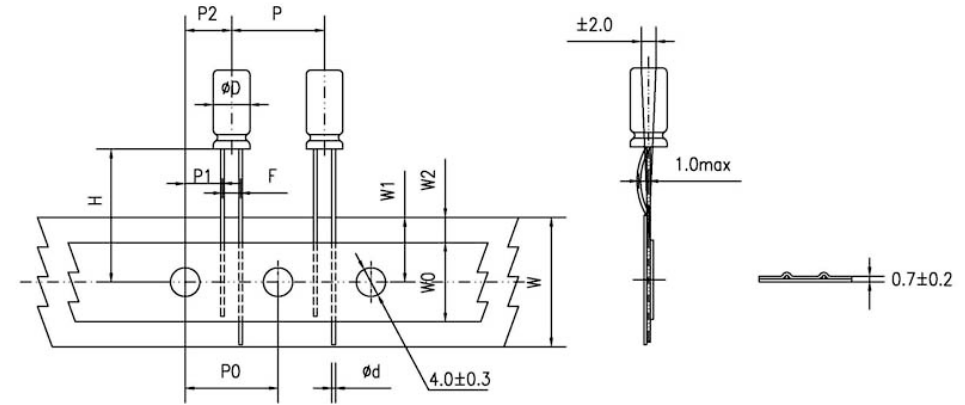

Fig.4 code: P



Lead Forming

Specification Fig.1 & Fig.2 & Fig.3

| Items | Symbol | Case size | | | | | | | | | | Tolerance | | |
|---|--------|------------|-----|------------|------|------|------|-------|----------------|------------------|-----------------------------------|-----------|--------------|--|
| | | 4*5 4*7 | | 5*5 5*7 | | 5*11 | | 6.3*5 | 6.3*7 6.3*9 | 6.3*11 6.3*12 | 8*5/7 8*9/11 8*11.5 8*12 | | 8*16 8*20 | 10*9/12 10*12.5 10*13/16 10*20/25 |
| Pin Code | | X | B | X | B | X | B | B | B | B | B | B | B | |
| Lead wire diameter | Φd | 0.45 | | 0.45 | | 0.5 | | 0.45 | 0.5 | 0.5 | 0.45/0.5 | 0.6 | 0.6 | ±0.05 |
| Pitch of body | P | 12.7 | | 12.7 | | 12.7 | | 12.7 | 12.7 | 12.7 | 12.7 | 12.7 | 12.7 | ±1.0 |
| Feed hole pitch | P0 | 12.7 | | 12.7 | | 12.7 | | 12.7 | 12.7 | 12.7 | 12.7 | 12.7 | 12.7 | ±0.2 |
| Distance from hole center to lead | P1 | 5.1 | 5.6 | 5.1 | 5.35 | 5.1 | 5.35 | 5.1 | 5.1 | 5.1 | 4.6 | 4.6 | 3.85 | ±0.7 |
| Distance from feed hole center to body center | P2 | 6.35 | | 6.35 | | 6.35 | | 6.35 | 6.35 | 6.35 | 6.35 | 6.35 | 6.35 | ±1.0 |
| Lead-to-lead distance | F | 2.5 | 1.5 | 2.5 | 2.0 | 2.5 | 2.0 | 2.5 | 2.5 | 2.5 | 3.5 | 3.5 | 5.0 | ±0.5 |
| Height of body from tape center | H | 18.5 | | 18.5 | | 18.5 | | 18.5 | 18.5 | 18.5 | 18.5 | 18.5 | 18.5 | ±0.75 |
| Base tape width | W | 18.0 | | 18.0 | | 18.0 | | 18.0 | 18.0 | 18.0 | 18.0 | 18.0 | 18.0 | ±0.5 |
| Adhesive tape width | W0 | 6.0 | | 6.0 | | 6.0 | | 6.0 | 6.0 | 8.0 | 8.0 | 8.0 | 11.0 | min |
| Hole position | W1 | 9.0 | | 9.0 | | 9.0 | | 9.0 | 9.0 | 9.0 | 9.0 | 9.0 | 9.0 | +0.75 -0.5 |
| Hole down tape position | W2 | 3.0 | | 3.0 | | 3.0 | | 3.0 | 3.0 | 3.0 | 3.0 | 3.0 | 3.0 | max |

Specification Fig.4

| Items | Symbol | Case size | | | | | | | | | Tolerance |
|---|--------|------------|------|------|------|-------|----------------|------------------|------------------------------|--------------|---------------|
| | | 4*5 4*7 | 5*5 | 5*7 | 5*11 | 6.3*5 | 6.3*7 6.3*9 | 6.3*11 6.3*12 | 8*5/7 8*9/11 8*11.5/12 | 8*16 8*20 | |
| Pin Code | | P | P | P | P | P | P | P | P | P | |
| Lead wire diameter | Φd | 0.45 | 0.45 | 0.45 | 0.5 | 0.45 | 0.5 | 0.5 | 0.45/0.5 | 0.6 | ±0.05 |
| Pitch of body | P | 12.7 | 12.7 | 12.7 | 12.7 | 12.7 | 12.7 | 12.7 | 12.7 | 12.7 | ±1.0 |
| Feed hole pitch | P0 | 12.7 | 12.7 | 12.7 | 12.7 | 12.7 | 12.7 | 12.7 | 12.7 | 12.7 | ±0.2 |
| Distance from hole center to lead | P1 | 3.85 | 3.85 | 3.85 | 3.85 | 3.85 | 3.85 | 3.85 | 3.85 | 3.85 | ±0.7 |
| Distance from feed hole center to body center | P2 | 6.35 | 6.35 | 6.35 | 6.35 | 6.35 | 6.35 | 6.35 | 6.35 | 6.35 | ±1.0 |
| Lead-to-lead distance | F | 1.5 | 2.0 | 2.0 | 2.0 | 2.5 | 2.5 | 2.5 | 3.5 | 3.5 | ±0.5 |
| Lead to lead distance | F1 | 5.0 | 5.0 | 5.0 | 5.0 | 5.0 | 5.0 | 5.0 | 5.0 | 5.0 | +0.8 -0.2 |
| Height of body from tape center | H | 18.5 | 18.5 | 18.5 | 18.5 | 18.5 | 18.5 | 18.5 | 18.5 | 18.5 | ±0.75 |
| Lead wire clinch height | H0 | 16.0 | 16.0 | 16.0 | 16.0 | 16.0 | 16.0 | 16.0 | 16.0 | 16.0 | ±0.5 |
| Base tape width | W | 18.0 | 18.0 | 18.0 | 18.0 | 18.0 | 18.0 | 18.0 | 18.0 | 18.0 | ±0.5 |
| Adhesive tape width | W0 | 6.0 | 6.0 | 6.0 | 6.0 | 6.0 | 6.0 | 8.0 | 8.0 | 8.0 | min |
| Hole position | W1 | 9.0 | 9.0 | 9.0 | 9.0 | 9.0 | 9.0 | 9.0 | 9.0 | 9.0 | +0.75 -0.5 |
| Hole down tape position | W2 | 3.0 | 3.0 | 3.0 | 3.0 | 3.0 | 3.0 | 3.0 | 3.0 | 3.0 | max |

Lead Forming

Lead Forming & Cut

Code:C
RANGE: $\Phi 4 \sim \Phi 18$



Code:F
RANGE: $\Phi 4 \sim \Phi 8$



| ΦD | F | L | ΦD | F | L |
|----------|-----|----------|----------|-----|--------------------|
| 4 | 1.5 | 3.0~12.0 | 4 | 5.0 | 3.5, 4.5, 5.0, 7.0 |
| 5 | 2.0 | 3.0~12.0 | 5 | 5.0 | 3.5, 4.5, 5.0, 7.0 |
| 6.3 | 2.5 | 3.0~12.0 | 6.3 | 5.0 | 3.5, 4.5, 5.0, 7.0 |
| 8 | 3.5 | 3.0~12.0 | 8 | 5.0 | 3.5, 4.5, 5.0, 7.0 |
| 10 | 5.0 | 3.0~12.0 | - | - | - |
| 12.5 | 5.0 | 3.0~12.0 | - | - | - |
| 16 | 7.5 | 3.0~12.0 | - | - | - |
| 18 | 7.5 | 3.0~12.0 | - | - | - |

Code:J
RANGE: $\Phi 10 \sim \Phi 18$



| ΦD | F | L |
|----------|-----|---------------|
| 10 | 5.0 | 4.0, 4.5, 5.0 |
| 12.5 | 5.0 | 4.0, 4.5, 5.0 |
| 16 | 7.5 | 4.0, 4.5, 5.0 |
| 18 | 7.5 | 4.0, 4.5, 5.0 |

CD11GD series

- Endurance: +105 °C 6,000 hours
- Miniaturized and high stability
- Suitable for output circuit and input circuit of LED driving power.
- RoHS Compliant



SPECIFICATIONS

| Items | Characteristics | | | | | | | | |
|--|--|--------------------------------------|------|--|------|------|------|------|---------------------------|
| Category Temperature Range | -40~+105°C(160~500 V _{dc}) | | | | | | | | |
| Rated Voltage Range | 160~500 V _{dc} | | | | | | | | |
| Capacitance Tolerance | ±20%(M) (at 20°C,120Hz) | | | | | | | | |
| Leakage Current | 160~400 V _{dc} | 450~500 V _{dc} | | Where, I: Max.leakage current (µA),C:Nominal capacitance (µF), V: Rated voltage (V) | | | | | (at 20°C after 2 minutes) |
| | I≤0.02CV+10µA | I≤0.03CV+10µA | | | | | | | |
| Dissipation Factor (tanδ) | Rated Voltage(V _{dc}) | 160 | 200 | 250 | 350 | 400 | 450 | 500 | (at 20°C,120Hz) |
| | tanδ (max.) | 0.15 | 0.15 | 0.15 | 0.20 | 0.20 | 0.20 | 0.24 | |
| Low Temperature Characteristics (Max. Impedance Ratio) | Rated Voltage(V _{dc}) | 160 | 200 | 250 | 350 | 400 | 450 | 500 | (at 120Hz) |
| | Z(-25°C)/Z(+20°C) | 3 | 3 | 3 | 5 | 5 | 6 | 6 | |
| | Z(-40°C)/Z(+20°C) | 6 | 6 | 6 | 6 | 6 | 9 | 15 | |
| Endurance | The specifications listed below shall be met when the capacitors are restored to 20 °C after DC voltage plus rated ripple current is applied for 6,000 hours at 105 °C, the peak voltage shall not exceed the rated voltage. | | | | | | | | |
| | Capacitance Change | ≤±20% of the initial value | | | | | | | |
| | D.F. (tanδ) | ≤200% of the initial specified value | | | | | | | |
| | Leakage Current | ≤The initial specified value | | | | | | | |
| Shelf Life | The following specifications shall be satisfied when the capacitors are restored to 20°C after leaving them under no load at 105°C for 1,000 hours. | | | | | | | | |
| | Capacitance Change | ≤±20% of the initial value | | | | | | | |
| | D.F. (tanδ) | ≤200% of the initial specified value | | | | | | | |
| | Leakage Current | ≤200% of the initial specified value | | | | | | | |

DIMENSIONS[mm]

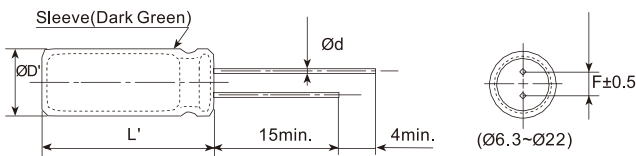

| | | | | | | | |
|-----|------------|-----|-----|------|-----|-----|-----|
| ØD | 6.3 | 8 | 10 | 12.5 | 16 | 18 | 22 |
| Ød | 0.5 | 0.5 | 0.6 | 0.6 | 0.8 | 0.8 | 0.8 |
| F | 2.5 | 3.5 | 5.0 | 5.0 | 7.5 | 7.5 | 10 |
| ØD' | ØD+0.5max. | | | | | | |
| L' | L+2max. | | | | | | |

PART NUMBERING SYSTEM

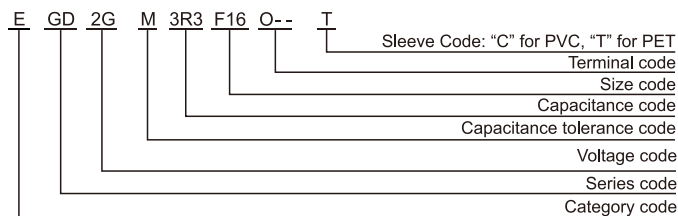

RATED RIPPLE CURRENT MULTIPLIERS

Frequency correction factor for ripple current

| Freq.(Hz) | 120 | 1k | 10k | 100k |
|---------------------------------|------|------|------|------|
| Rated voltage(V _{dc}) | 0.50 | 0.80 | 0.90 | 1.00 |

CD11GD series

■ STANDARD RATINGS

| WV (V _{dc}) | Cap (μF) | Size ΦDxL(mm) | tanδ | Rated ripple current (mA _{rms} /105°C,100kHz) |
|-----------------------|----------|---------------|------|--|
| 160(2C) | 1 | 6.3*7 | 0.15 | 34 |
| | | 6.3*9 | 0.15 | 36 |
| | | 6.3*12 | 0.15 | 40 |
| | 1.5 | 6.3*7 | 0.15 | 38 |
| | | 6.3*12 | 0.15 | 50 |
| | 1.8 | 6.3*7 | 0.15 | 49 |
| | | 6.3*9 | 0.15 | 50 |
| | | 6.3*12 | 0.15 | 56 |
| | 2.2 | 6.3*7 | 0.15 | 53 |
| | | 6.3*9 | 0.15 | 56 |
| | | 6.3*12 | 0.15 | 60 |
| | 2.8 | 6.3*7 | 0.15 | 57 |
| | | 6.3*9 | 0.15 | 60 |
| | | 6.3*12 | 0.15 | 65 |
| | 3.3 | 6.3*7 | 0.15 | 61 |
| | | 6.3*9 | 0.15 | 65 |
| | | 6.3*12 | 0.15 | 68 |
| | 3.9 | 6.3*7 | 0.15 | 65 |
| | | 6.3*9 | 0.15 | 68 |
| | | 6.3*7 | 0.15 | 66 |
| | 4.7 | 6.3*9 | 0.15 | 70 |
| | | 6.3*12 | 0.15 | 72 |
| | | 6.3*9 | 0.15 | 72 |
| | 5.6 | 8*9 | 0.15 | 74 |
| | | 8*12 | 0.15 | 76 |
| | | 6.3*12 | 0.15 | 84 |
| | 6.8 | 8*9 | 0.15 | 86 |
| | | 8*12 | 0.15 | 96 |
| | | 6.3*12 | 0.15 | 120 |
| | 8.2 | 8*9 | 0.15 | 135 |
| | | 6.3*12 | 0.15 | 145 |
| | | 8*9 | 0.15 | 165 |
| | 10 | 8*12 | 0.15 | 206 |
| 8*16 | | 0.15 | 216 | |
| 8*9 | | 0.15 | 180 | |
| 12 | 8*12 | 0.15 | 213 | |
| | 8*16 | 0.15 | 225 | |
| | 10*9 | 0.15 | 200 | |
| 15 | 8*16 | 0.15 | 330 | |
| | 8*20 | 0.15 | 360 | |
| | 10*16 | 0.15 | 360 | |
| 33 | 10*12 | 0.15 | 400 | |
| | 10*20 | 0.15 | 450 | |
| | 10*16 | 0.15 | 435 | |
| 47 | 10*20 | 0.15 | 500 | |
| | 10*20 | 0.15 | 530 | |
| 68 | 12.5*16 | 0.15 | 565 | |
| | 12.5*20 | 0.15 | 600 | |
| 100 | 12.5*20 | 0.15 | 700 | |
| | 12.5*25 | 0.15 | 722 | |
| | 16*20 | 0.15 | 722 | |
| 150 | 16*20 | 0.15 | 740 | |
| | 16*25 | 0.15 | 798 | |
| 220 | 16*25 | 0.15 | 900 | |
| 330 | 18*30 | 0.15 | 1100 | |

| WV (V _{dc}) | Cap (μF) | Size ΦDxL(mm) | tanδ | Rated ripple current (mA _{rms} /105°C,100kHz) |
|-----------------------|----------|---------------|------|--|
| 200(2D) | 1 | 6.3*7 | 0.15 | 35 |
| | | 6.3*9 | 0.15 | 38 |
| | | 6.3*12 | 0.15 | 42 |
| | 1.2 | 6.3*7 | 0.15 | 38 |
| | | 6.3*9 | 0.15 | 42 |
| | 1.5 | 6.3*7 | 0.15 | 49 |
| | | 6.3*9 | 0.15 | 50 |
| | | 6.3*12 | 0.15 | 54 |
| | 1.8 | 6.3*7 | 0.15 | 50 |
| | | 6.3*9 | 0.15 | 54 |
| | | 6.3*12 | 0.15 | 60 |
| | 2.2 | 6.3*7 | 0.15 | 55 |
| | | 6.3*9 | 0.15 | 60 |
| | | 6.3*12 | 0.15 | 68 |
| | 2.8 | 6.3*7 | 0.15 | 61 |
| | | 6.3*9 | 0.15 | 68 |
| | | 6.3*12 | 0.15 | 71 |
| | 3.3 | 6.3*7 | 0.15 | 65 |
| | | 6.3*9 | 0.15 | 72 |
| | | 6.3*12 | 0.15 | 78 |
| | 4.7 | 6.3*9 | 0.15 | 76 |
| | | 6.3*12 | 0.15 | 85 |
| | | 8*9 | 0.15 | 88 |
| | 5.6 | 6.3*12 | 0.15 | 90 |
| | | 8*9 | 0.15 | 92 |
| | | 8*12 | 0.15 | 98 |
| | 6.8 | 6.3*12 | 0.15 | 94 |
| | | 8*9 | 0.15 | 98 |
| | | 8*16 | 0.15 | 103 |
| | 8.2 | 8*9 | 0.15 | 145 |
| | | 8*12 | 0.15 | 180 |
| | 10 | 8*16 | 0.15 | 216 |
| | | 10*9 | 0.15 | 190 |
| 15 | 8*12 | 0.15 | 200 | |
| | 8*16 | 0.15 | 225 | |
| | 8*20 | 0.15 | 250 | |
| 22 | 8*20 | 0.15 | 380 | |
| | 10*12 | 0.15 | 320 | |
| | 10*16 | 0.15 | 380 | |
| 33 | 10*20 | 0.15 | 450 | |
| | 12.5*13 | 0.15 | 430 | |
| | 12.5*16 | 0.15 | 450 | |
| 47 | 10*20 | 0.15 | 520 | |
| | 12.5*16 | 0.15 | 520 | |
| | 12.5*20 | 0.15 | 580 | |
| 68 | 12.5*20 | 0.15 | 600 | |
| | 12.5*25 | 0.15 | 665 | |
| 100 | 12.5*25 | 0.15 | 700 | |
| | 16*25 | 0.15 | 760 | |
| 150 | 16*25 | 0.15 | 800 | |
| | 16*30 | 0.15 | 895 | |

Radial Type

CD11GD series

■ STANDARD RATINGS

| WV (V _{dc}) | Cap (μF) | Size ΦDxL(mm) | tanδ | Rated ripple current (mA _{rms} /105°C,100kHz) |
|-----------------------|----------|---------------|------|--|
| 250(2E) | 1 | 6.3*7 | 0.15 | 36 |
| | | 6.3*9 | 0.15 | 40 |
| | | 6.3*12 | 0.15 | 46 |
| | 1.2 | 6.3*7 | 0.15 | 41 |
| | | 6.3*9 | 0.15 | 46 |
| | | 6.3*12 | 0.15 | 51 |
| | 1.5 | 6.3*7 | 0.15 | 54 |
| | | 6.3*9 | 0.15 | 58 |
| | | 6.3*12 | 0.15 | 58 |
| | 1.8 | 6.3*7 | 0.15 | 54 |
| | | 6.3*9 | 0.15 | 58 |
| | | 6.3*12 | 0.15 | 62 |
| | 2.2 | 6.3*7 | 0.15 | 55 |
| | | 6.3*9 | 0.15 | 62 |
| | | 6.3*12 | 0.15 | 70 |
| | 2.8 | 6.3*7 | 0.15 | 63 |
| | | 6.3*9 | 0.15 | 70 |
| | | 6.3*12 | 0.15 | 78 |
| | 3.3 | 6.3*9 | 0.15 | 75 |
| | | 6.3*12 | 0.15 | 80 |
| | | 6.3*12 | 0.15 | 92 |
| | 4.7 | 8*9 | 0.15 | 92 |
| | | 8*12 | 0.15 | 102 |
| | | 8*9 | 0.15 | 95 |
| | 5.6 | 8*12 | 0.15 | 105 |
| | | 8*9 | 0.15 | 105 |
| | | 8*16 | 0.15 | 115 |
| | 8.2 | 8*10 | 0.15 | 108 |
| | | 8*16 | 0.15 | 120 |
| | | 10*9 | 0.15 | 110 |
| | 10 | 8*10 | 0.15 | 187 |
| | | 8*16 | 0.15 | 216 |
| | | 10*9 | 0.15 | 175 |
| | 15 | 8*16 | 0.15 | 225 |
| | | 8*20 | 0.15 | 250 |
| | | 8*16 | 0.15 | 350 |
| | 22 | 10*16 | 0.15 | 380 |
| | | 12.5*16 | 0.15 | 450 |
| | | 12.5*20 | 0.15 | 470 |
| | 47 | 12.5*16 | 0.15 | 520 |
| | | 12.5*20 | 0.15 | 580 |
| | | 12.5*25 | 0.15 | 660 |
| 68 | 16*25 | 0.15 | 720 | |
| | 16*20 | 0.15 | 730 | |
| | 16*30 | 0.15 | 836 | |
| 100 | 16*35 | 0.15 | 978 | |
| | 18*25 | 0.15 | 885 | |
| | 18*25 | 0.15 | 885 | |
| 350(2V) | 1 | 6.3*7 | 0.20 | 40 |
| | | 6.3*9 | 0.20 | 45 |
| | | 6.3*12 | 0.20 | 50 |
| | 1.2 | 6.3*7 | 0.20 | 55 |
| | | 6.3*9 | 0.20 | 50 |
| | 1.5 | 6.3*9 | 0.20 | 55 |
| | | 6.3*12 | 0.20 | 60 |
| | 1.8 | 6.3*9 | 0.20 | 60 |
| | | 6.3*12 | 0.20 | 64 |
| | 2.2 | 6.3*9 | 0.20 | 66 |
| | | 6.3*12 | 0.20 | 70 |
| | | 8*9 | 0.20 | 72 |

| WV (V _{dc}) | Cap (μF) | Size ΦDxL(mm) | tanδ | Rated ripple current (mA _{rms} /105°C,100kHz) |
|-----------------------|----------|---------------|------|--|
| 350(2V) | 2.8 | 8*9 | 0.20 | 76 |
| | | 8*12 | 0.20 | 80 |
| | 3.3 | 6.3*12 | 0.20 | 77 |
| | | 8*9 | 0.20 | 78 |
| | | 8*12 | 0.20 | 82 |
| | 4.7 | 8*9 | 0.20 | 90 |
| | | 8*12 | 0.20 | 102 |
| | | 10*9 | 0.20 | 104 |
| | 5.6 | 8*12 | 0.20 | 105 |
| | | 10*9 | 0.20 | 106 |
| | | 8*12 | 0.20 | 112 |
| | 6.8 | 8*20 | 0.20 | 128 |
| | | 10*9 | 0.20 | 120 |
| | 8.2 | 8*16 | 0.20 | 130 |
| | | 8*20 | 0.20 | 144 |
| | 10 | 8*20 | 0.20 | 226 |
| | | 10*12 | 0.20 | 205 |
| | 15 | 10*16 | 0.20 | 260 |
| | | 10*20 | 0.20 | 285 |
| | 22 | 12.5*20 | 0.20 | 410 |
| 33 | 12.5*20 | 0.20 | 425 | |
| 47 | 12.5*25 | 0.20 | 480 | |
| 68 | 16*20 | 0.20 | 600 | |
| 100 | 18*20 | 0.20 | 720 | |
| 100 | 18*25 | 0.20 | 850 | |
| 100 | 18*30 | 0.20 | 900 | |
| 400(2G) | 1 | 6.3*7 | 0.20 | 50 |
| | | 6.3*9 | 0.20 | 55 |
| | | 6.3*12 | 0.20 | 59 |
| | 1.2 | 6.3*9 | 0.20 | 59 |
| | | 6.3*12 | 0.20 | 63 |
| | 1.5 | 6.3*9 | 0.20 | 65 |
| | | 8*12 | 0.20 | 72 |
| | | 8*7 | 0.20 | 68 |
| | 1.8 | 8*9 | 0.20 | 70 |
| | | 8*12 | 0.20 | 75 |
| | | 6.3*9 | 0.20 | 68 |
| | 2.2 | 6.3*12 | 0.20 | 72 |
| | | 8*9 | 0.20 | 75 |
| | | 8*12 | 0.20 | 78 |
| | 2.8 | 6.3*12 | 0.20 | 74 |
| | | 8*9 | 0.20 | 78 |
| | | 8*16 | 0.20 | 85 |
| | | 8*7 | 0.20 | 78 |
| | | 8*9 | 0.20 | 85 |
| | | 8*12 | 0.20 | 91 |
| 3.3 | 8*16 | 0.20 | 95 | |
| | 8*9 | 0.20 | 90 | |
| | 8*12 | 0.20 | 104 | |
| 4.7 | 8*16 | 0.20 | 110 | |
| | 10*9 | 0.20 | 106 | |
| | 8*12 | 0.20 | 114 | |
| 5.6 | 8*20 | 0.20 | 138 | |
| | 10*16 | 0.20 | 138 | |
| | 8*16 | 0.20 | 132 | |
| 6.8 | 8*20 | 0.20 | 148 | |
| | 10*16 | 0.20 | 148 | |

CD11GD series

■ STANDARD RATINGS

| WV (V _{dc}) | Cap (μF) | Size ΦDxL (mm) | tanδ | Rated ripple current (mA _{rms} /105°C, 100kHz) |
|-----------------------|----------|----------------|------|---|
| 400(2G) | 8.2 | 10*16 | 0.20 | 218 |
| | | 10*20 | 0.20 | 230 |
| | 10 | 10*16 | 0.20 | 226 |
| | | 10*20 | 0.20 | 238 |
| | 15 | 10*20 | 0.20 | 255 |
| | | 12.5*16 | 0.20 | 270 |
| | | 12.5*20 | 0.20 | 300 |
| | 22 | 12.5*20 | 0.20 | 400 |
| | | 12.5*25 | 0.20 | 420 |
| | | 16*20 | 0.20 | 420 |
| | 33 | 16*25 | 0.20 | 550 |
| | | 16*30 | 0.20 | 579 |
| | 47 | 16*25 | 0.20 | 590 |
| | | 12.5*40 | 0.20 | 630 |
| | 68 | 16*30 | 0.20 | 637 |
| | | 18*25 | 0.20 | 700 |
| | 100 | 18*30 | 0.20 | 760 |
| | | 18*30 | 0.20 | 900 |
| 450(2W) | 1 | 6.3*9 | 0.20 | 55 |
| | | 8*12 | 0.20 | 60 |
| | 1.2 | 6.3*9 | 0.20 | 60 |
| | 1.5 | 8*9 | 0.20 | 65 |
| | | 8*12 | 0.20 | 70 |
| | 1.8 | 8*9 | 0.20 | 68 |
| | | 8*12 | 0.20 | 72 |
| | 2.2 | 8*9 | 0.20 | 72 |
| | | 8*16 | 0.20 | 75 |
| | 2.8 | 8*9 | 0.20 | 75 |
| | | 8*16 | 0.20 | 79 |
| | 3.3 | 8*12 | 0.20 | 80 |
| | | 8*16 | 0.20 | 86 |
| | | 10*9 | 0.20 | 80 |
| | 4.7 | 8*12 | 0.20 | 84 |
| | | 8*20 | 0.20 | 99 |

| WV (V _{dc}) | Cap (μF) | Size ΦDxL (mm) | tanδ | Rated ripple current (mA _{rms} /105°C, 100kHz) |
|-----------------------|----------|----------------|------|---|
| 450(2W) | 5.6 | 10*12 | 0.20 | 102 |
| | | 10*16 | 0.20 | 115 |
| | 6.8 | 10*12 | 0.20 | 130 |
| | | 10*20 | 0.20 | 158 |
| | 8.2 | 10*16 | 0.20 | 185 |
| | | 10*20 | 0.20 | 209 |
| | 10 | 10*16 | 0.20 | 218 |
| | | 10*20 | 0.20 | 225 |
| | | 12.5*16 | 0.20 | 225 |
| | 15 | 12.5*20 | 0.20 | 332 |
| | 22 | 12.5*25 | 0.20 | 427 |
| | 33 | 10*45 | 0.20 | 510 |
| | | 16*25 | 0.20 | 522 |
| | 47 | 12.5*45 | 0.20 | 660 |
| | | 16*25 | 0.20 | 630 |
| | 68 | 16*35 | 0.20 | 700 |
| | | 18*30 | 0.20 | 769 |
| | 100 | 18*35 | 0.20 | 890 |
| 18*40 | | 0.20 | 950 | |
| 500(2H) | 10 | 12.5*20 | 0.24 | 259 |
| | | 12.5*25 | 0.24 | 272 |
| | 15 | 12.5*25 | 0.24 | 356 |
| | | 16*20 | 0.24 | 356 |
| | 22 | 12.5*35 | 0.24 | 453 |
| | | 16*25 | 0.24 | 453 |
| | 33 | 18*25 | 0.24 | 567 |
| | 47 | 18*30 | 0.24 | 713 |
| | 68 | 22*35 | 0.24 | 1000 |
| | 100 | 22*35 | 0.24 | 1400 |

Radial Type

Solering Recommendation

■ Flow Soldering(Radial Lead Type)

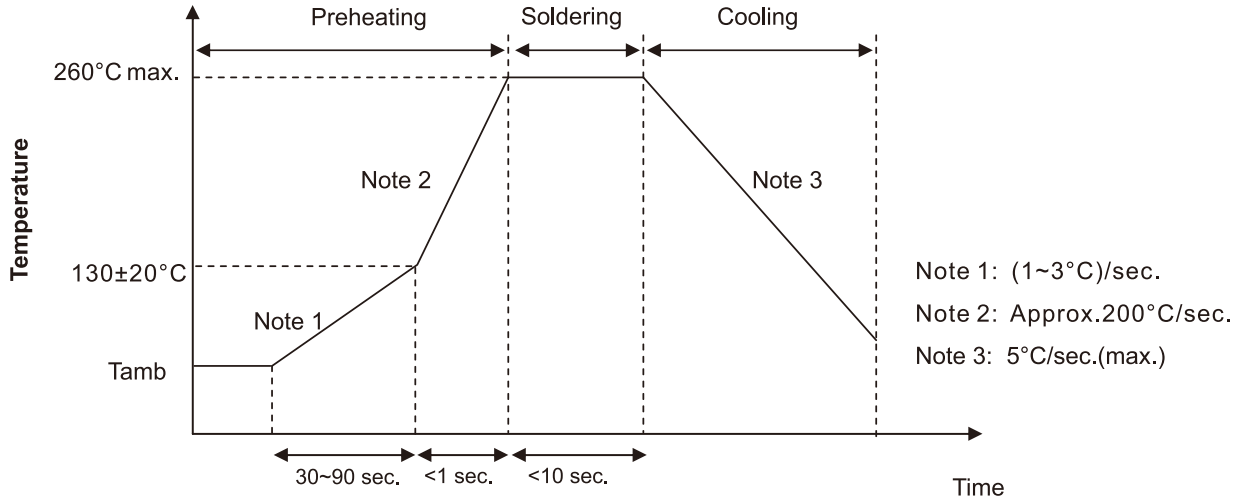

■ Reflow Soldering

- (For Polymer SMD Type)

Recommended Reflow Profile

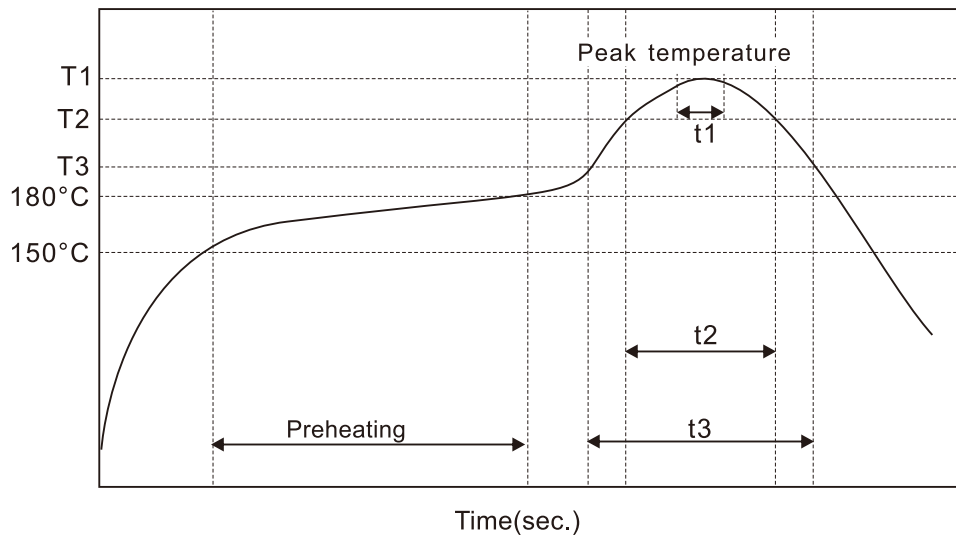

| Item | Preheating | T1(°C) | T2(°C) | T3(°C) | t1(sec.) | t2(sec.) | t3(sec.) | Reflow cycle |
|-------------|---------------------------------|--------|--------|--------|----------|----------|----------|--------------|
| Condition 1 | 150°C to 180°C Within 90sec. | ≤260 | 230 | 200 | ≤10 | ≤40 | ≤60 | 1 |
| Condition 2 | | ≤250 | 230 | 200 | ≤10 | ≤40 | ≤60 | 2 |

● (For Liquid SMD Type)

Case size: $\Phi 6.3$ – $\Phi 10$ mm:

- Temperature at surface of capacitor shall not exceed $T^{\circ}\text{C}$.
- The duration for over 200°C temperature and $T_1^{\circ}\text{C}$ at surface of capacitor shall not exceed t and t_1 seconds, respectively.
- Preheat shall be done at 100°C to 200°C and for Maximum 180 seconds.

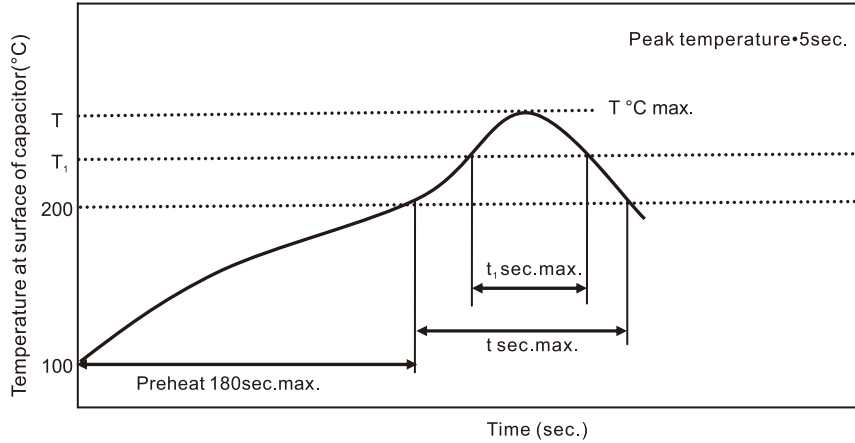

| Case size (mm) | $T(^{\circ}\text{C})$ ① | $T_1(^{\circ}\text{C})$ | $t(\text{sec.})$ ② | $t_1(\text{sec.})$ ③ | Reflow cycle |
|----------------|-------------------------|-------------------------|--------------------|----------------------|--------------|
| $\Phi 6.3$ | 250 | 230 | 90 | 40 | 1 |
| $\Phi 8$ | 240 | 230 | 90 | 30 | 1 |
| $\Phi 10$ | 235 | 230 | 60 | 30 | 1 |

- ① Peak temperature
- ② The duration over 200°C (max.)
- ③ The duration over $T_1^{\circ}\text{C}$
- Please contact us if capacitors are subject to the conditions other than the allowable range of reflow.

Case size: $\Phi 12.5$ – $\Phi 18$ mm:

- Temperature at surface of capacitor shall not exceed $T^{\circ}\text{C}$.
- The duration for over 200°C temperature and $T_1^{\circ}\text{C}$ at surface of capacitor shall not exceed t and t_1 seconds, respectively.
- Preheat shall be done at 100°C to 180°C and for Maximum 150 seconds.

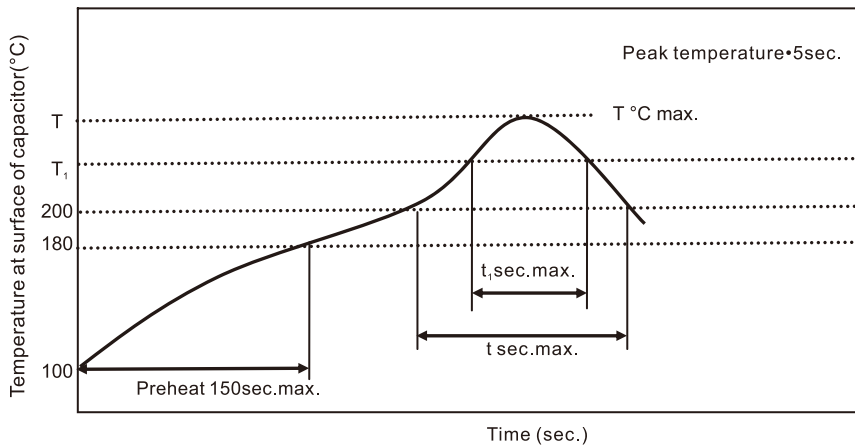

| Case size (mm) | $T(^{\circ}\text{C})$ ① | $T_1(^{\circ}\text{C})$ | $t(\text{sec.})$ ② | $t_1(\text{sec.})$ ③ | Reflow cycle |
|-------------------------|-------------------------|-------------------------|--------------------|----------------------|--------------|
| $\Phi 12.5$ – $\Phi 18$ | 240 | 230 | 60 | 30 | 1 |

- ① Peak temperature
- ② The duration over 200°C (max.)
- ③ The duration over $T_1^{\circ}\text{C}$
- Please contact us if capacitors are subject to the conditions other than the allowable range of reflow.

X-ON Electronics

Largest Supplier of Electrical and Electronic Components

Click to view similar products for [Aluminium Electrolytic Capacitors - Radial Leaded](#) category:

Click to view products by [Aihua](#) manufacturer:

Other Similar products are found below :

[LXY50VB4.7M-5X11](#) [RFO-100V471MJ7P#](#) [ECE-A1EGE220](#) [B41041A2687M8](#) [B41041A7226M8](#) [B41044A7157M6](#)
[EKXG201EC3101ML20S](#) [EKZM160ETD471MHB5D](#) [NCD681K10KVY5PF](#) [NEV1000M25EF-BULK](#) [NEV100M35DC](#) [NEV100M63DE](#)
[NEV220M25DD-BULK](#) [NEV.33M100AA](#) [NEV4700M50HB](#) [NEV.47M100AA](#) [NEVH1.0M250AB](#) [NEVH3.3M250BB](#) [NEVH3.3M450CC](#)
[KM4700/16](#) [KME50VB100M-8X11.5](#) [SG220M1CSA-0407](#) [ES5107M016AE1DA](#) [ESMG160ETD102MJ16S](#) [ESX472M16B](#)
[SZ010M1500A5S-1015](#) [227RZS050M](#) [476CKH100MSA](#) [UVX1V101KPA1FA](#) [UVX1V222MHA1CA](#) [KME25VB100M-6.3X11](#)
[VTL100S10](#) [VTL470S10](#) [VTL470S16A](#) [511D336M250EK5D](#) [052687X](#) [ECE-A1CF471](#) [EKMA500ELL4R7ME07D](#) [NRE-](#)
[S560M16V6.3X7TBSTF](#) [RGA221M1CTA-0611G](#) [ERZA630VHN182UP54N](#) [UPL1A331MPH](#) [MAL214658821E3](#) [NEV1000M6.3DE](#)
[NEV100M16CB](#) [NEV100M50DD-BULK](#) [NEV2200M16FF](#) [NEV220M50EE](#) [NEV2.2M50AA](#) [NEV330M63EF](#)