

## Part Numbering System



① Category code

Type	Code
	1
Electrolytic Capacitor	E
Conductive Polymer	S

② Series code

Series name	Code	
	2	3
WH	W	H
CD11GE	G	E
CD11GES	G	X
CD11GAS	G	W
CD11GHS	G	S
NR	N	R
PZ	P	Z

③ Voltage code

WV (V <sub>dc</sub> )	Code	
	4	5
2.5	0	E
3	0	D
4	0	G
6.3	0	J
6.8	0	C
7	0	Q
7.5	0	A
10	1	A
12	1	T
16	1	C
25	1	E
35	1	V
40	1	G
50	1	H
63	1	J
80	1	B
100	1	K
120	2	B
160	2	C
180	2	L
200	2	D
220	2	N
250	2	E
315	2	F
350	2	V
380	2	P
400	2	G
420	2	T
450	2	W
500	2	H
550	2	J
600	2	K

④ Capacitance tolerance code

Tol. (%)	Code
	6
-10~+10	K
-20~+20	M
-10~+30	Q
-10~+20	V
0~+20	A
-5~+20	C
-10~-20	B
-5~+5	D
0~+10	E
-5~-20	F
-15~+5	N

⑤ Capacitance code

Cap (μF)	Code		
	7	8	9
0.10	R	1	0
0.22	R	2	2
0.33	R	3	3
0.47	R	4	7
0.68	R	6	8
1	0	1	0
2.2	2	R	2
3.3	3	R	3
4.7	4	R	7
6.8	6	R	8
10	1	0	0
22	2	2	0
33	3	3	0
47	4	7	0
68	6	8	0
100	1	0	1
220	2	2	1
330	3	3	1
470	4	7	1
680	6	8	1
1000	1	0	2
2200	2	2	2
3300	3	3	2
4700	4	7	2
6800	6	8	2
10000	1	0	3
22000	2	2	3
33000	3	3	3
68000	6	8	3

⑥ Size code

ΦD (mm)	Code
10	
4	C
5	D
6.3	E
8	F
10	G
11	H
12	J
12.5	W
13	K
14	X
16	L
18	M
19	Z
20	N
22	O
25	P
30	Q
35	R
40	Y
51.6	S
64.3	T
76.9	U
91	V
100	A

L (mm)	Code	
	11	12
5	0	5
7	0	7
11	1	1
12	1	2
16	1	6
20	2	0
25	2	5
30	3	0
35	3	5
40	4	0
46	4	6
50	5	0
60	6	0
80	8	0
100	A	0
115	B	5
120	C	0
130	D	0
140	E	0
160	G	0
200	K	0
220	M	0
236	N	6
250	P	0

⑦ Terminal code

Specification	Code	Size	
	13	14	15
Bulk packing	O	-	-
Taping (SMD Type)	D	0	0
Φ4~8 Taping F=5.0mm	P	5	0
Φ10~12.5 Taping F=5.0mm	B	5	0
Lead Cut L=3.5mm	C	3	5
Lead Cut L=11.0mm	C	B	0
Lead Forming & Cut L=4.5mm	F	-	-
Kink & Cut L=4.5mm	J	-	-
Snap-in type Terminal 4.0mm in length	K	-	-
Three Terminals	T	-	-
Ring clip mounting standard design	A	0	0
Ring clip mounting special design	S	-	-

⑧ Sleeve/Marking code

Sleeve/Marking	Code
	16
PVC	C
PET	T
Dark blue	B
Bright red	R
Sky-blue	S
Light blue	T
Pink	Z
Black	H
Purple-blue	V
Red	O

Lead Forming  
Taping Specifications

Fig.1 code: X



Fig.2 code: B



Fig.3 code: B



Fig.4 code: P

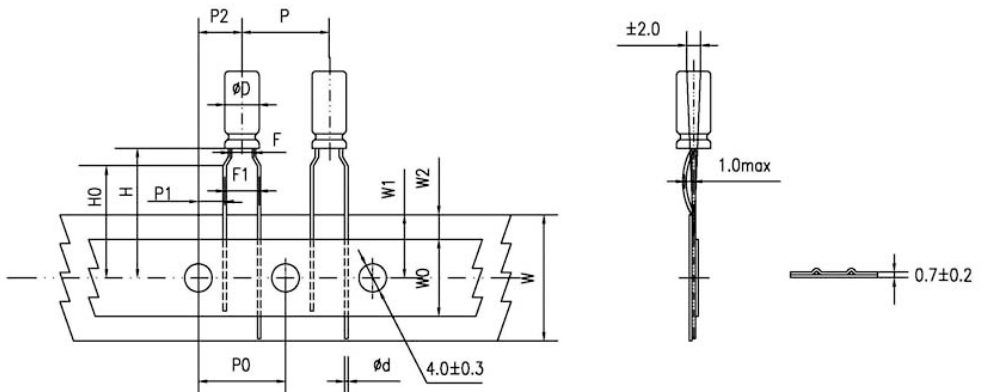

## Lead Forming

Specification Fig.1 & Fig.2 & Fig.3

Items	Symbol	Case size										Tolerance		
		4*5 4*7		5*5 5*7		5*11		6.3*5	6.3*7 6.3*9	6.3*11 6.3*12	8*5/7 8*9/11 8*11.5 8*12		8*16 8*20	10*9/12 10*12.5 10*13/16 10*20/25
Pin Code		X	B	X	B	X	B	B	B	B	B	B	B	
Lead wire diameter	Φd	0.45		0.45		0.5		0.45	0.5	0.5	0.45/0.5	0.6	0.6	±0.05
Pitch of body	P	12.7		12.7		12.7		12.7	12.7	12.7	12.7	12.7	12.7	±1.0
Feed hole pitch	P0	12.7		12.7		12.7		12.7	12.7	12.7	12.7	12.7	12.7	±0.2
Distance from hole center to lead	P1	5.1	5.6	5.1	5.35	5.1	5.35	5.1	5.1	5.1	4.6	4.6	3.85	±0.7
Distance from feed hole center to body center	P2	6.35		6.35		6.35		6.35	6.35	6.35	6.35	6.35	6.35	±1.0
Lead-to-lead distance	F	2.5	1.5	2.5	2.0	2.5	2.0	2.5	2.5	2.5	3.5	3.5	5.0	±0.5
Height of body from tape center	H	18.5		18.5		18.5		18.5	18.5	18.5	18.5	18.5	18.5	±0.75
Base tape width	W	18.0		18.0		18.0		18.0	18.0	18.0	18.0	18.0	18.0	±0.5
Adhesive tape width	W0	6.0		6.0		6.0		6.0	6.0	8.0	8.0	8.0	11.0	min
Hole position	W1	9.0		9.0		9.0		9.0	9.0	9.0	9.0	9.0	9.0	+0.75 -0.5
Hole down tape position	W2	3.0		3.0		3.0		3.0	3.0	3.0	3.0	3.0	3.0	max

Specification Fig.4

Items	Symbol	Case size									Tolerance
		4*5 4*7	5*5	5*7	5*11	6.3*5	6.3*7 6.3*9	6.3*11 6.3*12	8*5/7 8*9/11 8*11.5/12	8*16 8*20	
Pin Code		P	P	P	P	P	P	P	P	P	
Lead wire diameter	Φd	0.45	0.45	0.45	0.5	0.45	0.5	0.5	0.45/0.5	0.6	±0.05
Pitch of body	P	12.7	12.7	12.7	12.7	12.7	12.7	12.7	12.7	12.7	±1.0
Feed hole pitch	P0	12.7	12.7	12.7	12.7	12.7	12.7	12.7	12.7	12.7	±0.2
Distance from hole center to lead	P1	3.85	3.85	3.85	3.85	3.85	3.85	3.85	3.85	3.85	±0.7
Distance from feed hole center to body center	P2	6.35	6.35	6.35	6.35	6.35	6.35	6.35	6.35	6.35	±1.0
Lead-to-lead distance	F	1.5	2.0	2.0	2.0	2.5	2.5	2.5	3.5	3.5	±0.5
Lead to lead distance	F1	5.0	5.0	5.0	5.0	5.0	5.0	5.0	5.0	5.0	+0.8 -0.2
Height of body from tape center	H	18.5	18.5	18.5	18.5	18.5	18.5	18.5	18.5	18.5	±0.75
Lead wire clinch height	H0	16.0	16.0	16.0	16.0	16.0	16.0	16.0	16.0	16.0	±0.5
Base tape width	W	18.0	18.0	18.0	18.0	18.0	18.0	18.0	18.0	18.0	±0.5
Adhesive tape width	W0	6.0	6.0	6.0	6.0	6.0	6.0	8.0	8.0	8.0	min
Hole position	W1	9.0	9.0	9.0	9.0	9.0	9.0	9.0	9.0	9.0	+0.75 -0.5
Hole down tape position	W2	3.0	3.0	3.0	3.0	3.0	3.0	3.0	3.0	3.0	max

### Lead Forming

#### Lead Forming & Cut

Code:C  
RANGE:  $\Phi 4\sim\Phi 18$



Code:F  
RANGE:  $\Phi 4\sim\Phi 8$



$\Phi D$	F	L	$\Phi D$	F	L
4	1.5	3.0~12.0	4	5.0	3.5, 4.5, 5.0, 7.0
5	2.0	3.0~12.0	5	5.0	3.5, 4.5, 5.0, 7.0
6.3	2.5	3.0~12.0	6.3	5.0	3.5, 4.5, 5.0, 7.0
8	3.5	3.0~12.0	8	5.0	3.5, 4.5, 5.0, 7.0
10	5.0	3.0~12.0	-	-	-
12.5	5.0	3.0~12.0	-	-	-
16	7.5	3.0~12.0	-	-	-
18	7.5	3.0~12.0	-	-	-

Code:J  
RANGE:  $\Phi 10\sim\Phi 18$



$\Phi D$	F	L
10	5.0	4.0, 4.5, 5.0
12.5	5.0	4.0, 4.5, 5.0
16	7.5	4.0, 4.5, 5.0
18	7.5	4.0, 4.5, 5.0

# CD11GAS series

- Upgrade for CD11GA Series, longer life, better performance
- Endurance: +105°C 10,000 hours
- Suitable for LED driver.
- RoHS Compliant

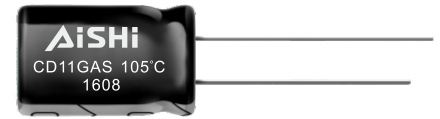

## SPECIFICATIONS

Items	Characteristics								
Category Temperature Range	-40~+105°C (160~ 500 V <sub>dc</sub> )								
Rated Voltage Range	160~500 V <sub>dc</sub>								
Capacitance Tolerance	±20%(M) (at 20°C, 120Hz)								
Leakage Current	160~400 V <sub>dc</sub>	450~500 V <sub>dc</sub>		Where, I: Max.leakage current (μA), C:Nominal capacitance (μF), V: Rated voltage (V)					(at 20°C after 2 minutes)
	I≤0.02CV+10μA	I≤0.03CV+10μA							
Dissipation Factor (tanδ)	Rated Voltage(V <sub>dc</sub> )	160	200	250	350	400	450	500	(at 20°C, 120Hz)
	tanδ (max.)	0.15	0.15	0.15	0.20	0.20	0.20	0.24	
Low Temperature Characteristics (Max. Impedance Ratio)	Rated Voltage(V <sub>dc</sub> )	160	200	250	350	400	450	500	(at 120Hz)
	Z(-25°C)/Z(+20°C)	3	3	3	5	5	6	6	
	Z(-40°C)/Z(+20°C)	6	6	6	6	6	9	15	
Endurance	The specifications listed below shall be met when the capacitors are restored to 20°C after DC voltage plus the rated ripple current is applied for 10,000 hours at 105°C(WV:500V for 8,000 hours), the peak voltage shall not exceed the rated voltage.								
	Capacitance Change	≤±20% of the initial value							
	D.F. (tanδ)	≤200% of the initial specified value							
	Leakage Current	≤The initial specified value							
Shelf Life	The following specifications shall be satisfied when the capacitors are restored to 20°C after leaving them under no load at 105°C for 1,000 hours.								
	Capacitance Change	≤±20% of the initial value							
	D.F. (tanδ)	≤200% of the initial specified value							
	Leakage Current	≤200% of the initial specified value							

## DIMENSIONS [mm]

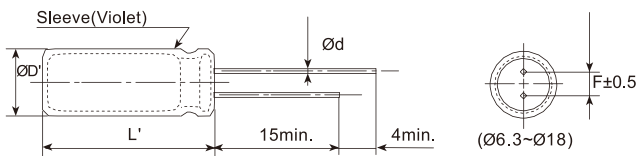

ØD	6.3	8	10	12.5	16	18
Ød	0.5	0.5	0.6	0.6	0.8	0.8
F	2.5	3.5	5.0	5.0	7.5	7.5
ØD'	ØD+0.5max.					
L'	L+2max.					

## PART NUMBERING SYSTEM

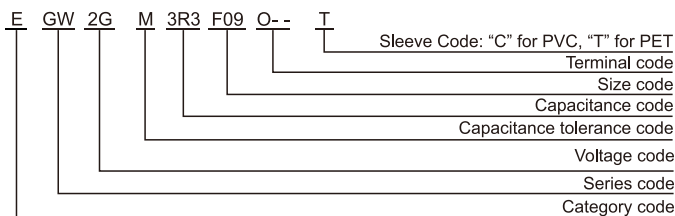

## RATED RIPPLE CURRENT MULTIPLIERS

Frequency correction factor for ripple current

Rated voltage(V <sub>dc</sub> )	Freq.(Hz)			
160~500	120	1k	10k	100k
	0.50	0.80	0.90	1.00

# CD11GAS series

■ STANDARD RATINGS

WV (V <sub>dc</sub> )	Cap (μF)	Size ΦDxL(mm)	tanδ	Rated ripple current (mArms/105°C,100kHz)
160(2C)	1	6.3*7	0.15	36
		6.3*9	0.15	40
		6.3*12	0.15	45
	1.5	6.3*7	0.15	40
		6.3*12	0.15	50
	1.8	6.3*7	0.15	45
		6.3*9	0.15	50
		6.3*12	0.15	55
	2.2	6.3*7	0.15	50
		6.3*9	0.15	55
		6.3*12	0.15	61
	2.8	6.3*9	0.15	70
		6.3*12	0.15	78
	3.3	6.3*9	0.15	85
		6.3*12	0.15	92
	4.7	6.3*9	0.15	92
		8*12	0.15	100
	5.6	8*9	0.15	100
		8*12	0.15	107
	6.8	8*9	0.15	107
		8*16	0.15	115
	8.2	8*9	0.15	150
8*16		0.15	189	
10	8*9	0.15	190	
	8*16	0.15	275	
15	8*12	0.15	290	
	8*20	0.15	340	
22	10*9	0.15	280	
	10*12	0.15	430	
33	10*16	0.15	475	
	10*16	0.15	520	
47	10*20	0.15	650	
	10*16	0.15	680	
68	10*20	0.15	750	
	12.5*16	0.15	1060	
100	12.5*20	0.15	1180	
	12.5*20	0.15	1350	
150	12.5*25	0.15	1420	
	16*20	0.15	1790	
220	16*25	0.15	1890	
	16*25	0.15	2130	
200(2D)	1	6.3*7	0.15	45
		6.3*9	0.15	50
		6.3*12	0.15	58
	1.2	6.3*7	0.15	50
		6.3*9	0.15	55
	1.5	6.3*7	0.15	55
		6.3*9	0.15	60
		6.3*12	0.15	66
	1.8	6.3*7	0.15	60
		6.3*9	0.15	66
		6.3*12	0.15	70
	2.2	6.3*9	0.15	72
		6.3*12	0.15	81
	2.8	6.3*9	0.15	81
		6.3*12	0.15	88
		6.3*9	0.15	105
	3.3	6.3*12	0.15	112

WV (V <sub>dc</sub> )	Cap (μF)	Size ΦDxL(mm)	tanδ	Rated ripple current (mArms/105°C,100kHz)
200(2D)	4.7	6.3*12	0.15	115
		8*9	0.15	117
		8*12	0.15	120
	5.6	8*9	0.15	120
		8*12	0.15	126
	6.8	8*9	0.15	126
		8*16	0.15	140
	8.2	8*16	0.15	260
		10*9	0.15	200
	10	8*16	0.15	275
		10*9	0.15	220
	15	8*20	0.15	345
		10*16	0.15	475
	33	10*20	0.15	650
		12.5*16	0.15	650
	47	12.5*16	0.15	880
		12.5*20	0.15	980
	68	12.5*25	0.15	1300
16*20		0.15	1380	
100	16*20	0.15	1420	
	16*25	0.15	1494	
150	16*25	0.15	1680	
	16*30	0.15	1989	
250(2E)	1	6.3*7	0.15	45
		6.3*9	0.15	50
		6.3*12	0.15	58
	1.2	6.3*7	0.15	50
		6.3*9	0.15	55
	1.5	6.3*7	0.15	55
		6.3*9	0.15	60
		6.3*12	0.15	66
	1.8	6.3*7	0.15	61
		6.3*9	0.15	70
	2.2	6.3*12	0.15	77
		6.3*9	0.15	72
	2.8	6.3*12	0.15	81
		6.3*9	0.15	81
	3.3	6.3*12	0.15	88
		8*9	0.15	112
	4.7	8*9	0.15	114
		8*12	0.15	115
	5.6	8*12	0.15	120
		8*9	0.15	120
	6.8	8*12	0.15	126
		8*9	0.15	145
8.2	8*16	0.15	160	
	10*9	0.15	150	
10	8*16	0.15	260	
	10*9	0.15	200	
15	8*16	0.15	275	
	8*20	0.15	378	
22	10*16	0.15	480	
	10*20	0.15	500	
33	12.5*16	0.15	600	
	12.5*20	0.15	660	
47	12.5*16	0.15	880	
	12.5*20	0.15	980	
68	16*25	0.15	1320	
	16*25	0.15	1420	
100	16*30	0.15	1500	
	16*35	0.15	2000	

# CD11GAS series

■ STANDARD RATINGS

WV (V <sub>dc</sub> )	Cap (μF)	Size ΦDxL(mm)	tanδ	Rated ripple current (mA <sub>rms</sub> /105°C,100kHz)
350(2V)	1	6.3*9	0.20	55
		6.3*12	0.20	60
	1.2	6.3*9	0.20	60
		6.3*12	0.20	65
	1.5	6.3*9	0.20	72
		6.3*12	0.20	80
	1.8	6.3*9	0.20	82
		6.3*12	0.20	86
	2.2	8*9	0.20	90
		8*12	0.20	95
	2.8	8*9	0.20	100
		8*12	0.20	108
	3.3	8*9	0.20	128
		8*12	0.20	120
	4.7	8*16	0.20	162
		10*9	0.20	145
	5.6	8*16	0.20	215
		10*9	0.20	220
	6.8	8*20	0.20	260
		8*20	0.20	380
8.2	8*20	0.20	525	
	8*20	0.20	600	
10	10*20	0.20	650	
	10*20	0.20	700	
15	12.5*20	0.20	780	
	12.5*20	0.20	850	
22	16*20	0.20	1000	
	16*20	0.20		
400(2G)	1	6.3*7	0.20	61
		6.3*9	0.20	65
	1.2	6.3*9	0.20	74
		6.3*12	0.20	76
	1.5	8*9	0.20	76
		8*12	0.20	85
	1.8	8*9	0.20	85
		8*12	0.20	90
	2.2	8*9	0.20	99
		8*12	0.20	100
	2.8	8*9	0.20	108
		8*12	0.20	130
	3.3	8*9	0.20	175
		8*16	0.20	215
	4.7	8*20	0.20	232
		10*9	0.20	240
	5.6	8*20	0.20	253
		10*16	0.20	275
	6.8	10*16	0.20	300
		10*20	0.20	
8.2	10*16	0.20		
	10*20	0.20		
10	10*16	0.20		
	10*20	0.20		
12	10*16	0.20		
	12.5*20	0.20		

WV (V <sub>dc</sub> )	Cap (μF)	Size ΦDxL(mm)	tanδ	Rated ripple current (mA <sub>rms</sub> /105°C,100kHz)
400(2G)	15	12.5*16	0.20	324
		12.5*20	0.20	360
	22	12.5*25	0.20	500
		16*20	0.20	500
	33	16*20	0.20	585
		16*25	0.20	620
	47	16*25	0.20	730
		16*30	0.20	756
	56	16*40	0.20	800
		18*30	0.20	900
100	18*40	0.20	1200	
450(2W)	1	6.3*9	0.20	76
		8*12	0.20	82
	1.2	8*9	0.20	80
		8*9	0.20	82
	1.5	8*12	0.20	85
		8*12	0.20	88
	1.8	10*9	0.20	90
		8*12	0.20	91
	2.2	8*16	0.20	95
		10*9	0.20	92
	2.8	8*16	0.20	99
		10*9	0.20	95
	3.3	8*16	0.20	100
		10*9	0.20	98
	3.9	10*9	0.20	115
		10*12	0.20	123
	4.7	10*16	0.20	130
		10*16	0.20	167
	5.6	10*20	0.20	177
		10*16	0.20	195
6.8	10*20	0.20	215	
	10*16	0.20	220	
8.2	10*20	0.20	230	
	10*25	0.20	300	
10	12.5*16	0.20	280	
	12.5*20	0.20	410	
15	12.5*25	0.20	530	
	16*20	0.20	530	
22	16*25	0.20	670	
	16*30	0.20	800	
33	16*35	0.20	850	
	18*30	0.20	1080	
47	18*30	0.20	1230	
	18*35	0.20	1300	
56	18*35	0.20	1300	
	18*40	0.20	1530	
500(2H)	10	12.5*20	0.24	288
		12.5*25	0.24	302
	15	12.5*25	0.24	396
		16*20	0.24	396
	22	12.5*35	0.24	504
		16*25	0.24	504
	33	18*25	0.24	630
		18*30	0.24	792

Radial Type

### Solering Recommendation

■ Flow Soldering(Radial Lead Type)



■ Reflow Soldering

- (For Polymer SMD Type)

#### Recommended Reflow Profile

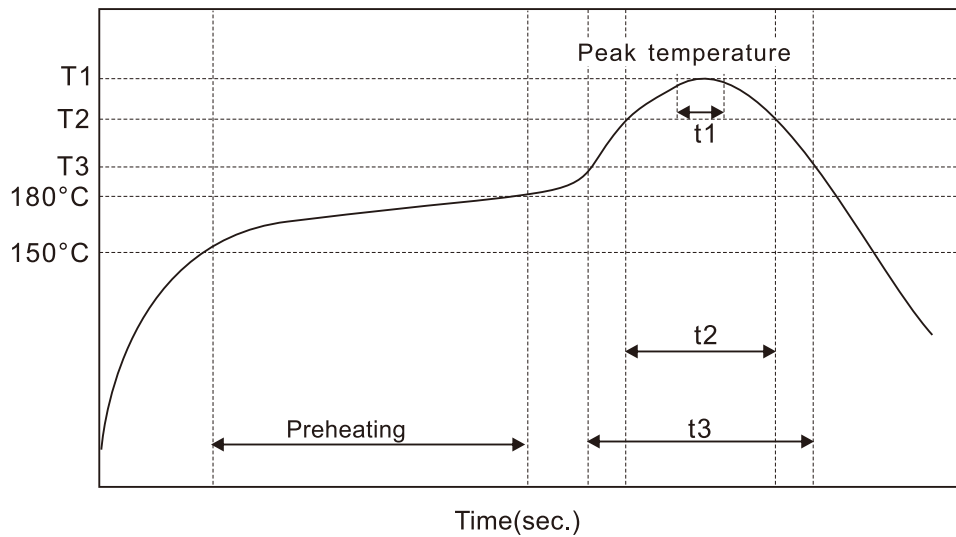

Item	Preheating	T1(°C)	T2(°C)	T3(°C)	t1(sec.)	t2(sec.)	t3(sec.)	Reflow cycle
Condition 1	150°C to 180°C Within 90sec.	≤260	230	200	≤10	≤40	≤60	1
Condition 2		≤250	230	200	≤10	≤40	≤60	2



● (For Liquid SMD Type)

Case size:  $\Phi 6.3$ – $\Phi 10$ mm:

- Temperature at surface of capacitor shall not exceed  $T^{\circ}\text{C}$ .
- The duration for over  $200^{\circ}\text{C}$  temperature and  $T_1^{\circ}\text{C}$  at surface of capacitor shall not exceed  $t$  and  $t_1$  seconds, respectively.
- Preheat shall be done at  $100^{\circ}\text{C}$  to  $200^{\circ}\text{C}$  and for Maximum 180 seconds.

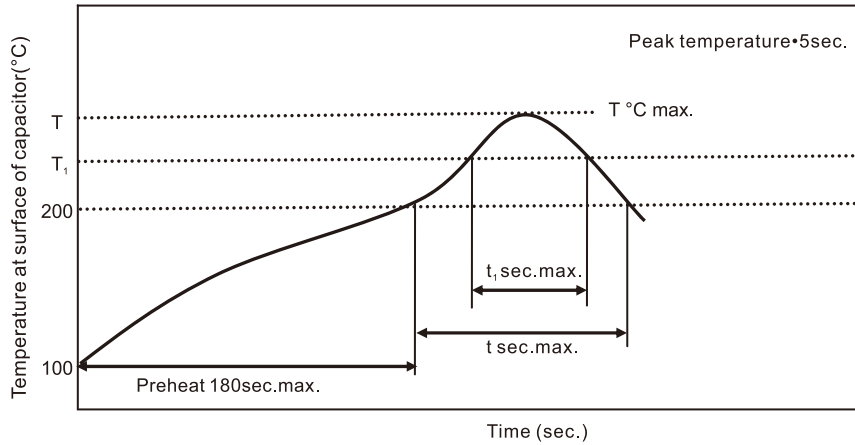

Case size (mm)	$T(^{\circ}\text{C})$ ①	$T_1(^{\circ}\text{C})$	$t(\text{sec.})$ ②	$t_1(\text{sec.})$ ③	Reflow cycle
$\Phi 6.3$	250	230	90	40	1
$\Phi 8$	240	230	90	30	1
$\Phi 10$	235	230	60	30	1

- ① Peak temperature
- ② The duration over  $200^{\circ}\text{C}$  (max.)
- ③ The duration over  $T_1^{\circ}\text{C}$
- Please contact us if capacitors are subject to the conditions other than the allowable range of reflow.

Case size:  $\Phi 12.5$ – $\Phi 18$ mm:

- Temperature at surface of capacitor shall not exceed  $T^{\circ}\text{C}$ .
- The duration for over  $200^{\circ}\text{C}$  temperature and  $T_1^{\circ}\text{C}$  at surface of capacitor shall not exceed  $t$  and  $t_1$  seconds, respectively.
- Preheat shall be done at  $100^{\circ}\text{C}$  to  $180^{\circ}\text{C}$  and for Maximum 150 seconds.

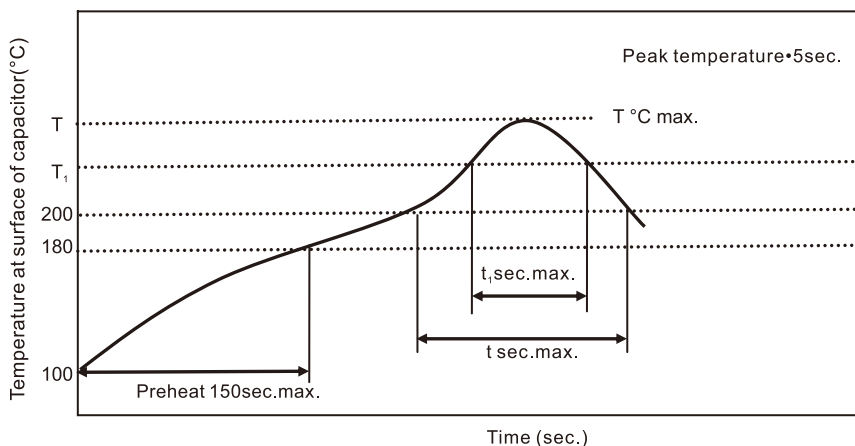

Case size (mm)	$T(^{\circ}\text{C})$ ①	$T_1(^{\circ}\text{C})$	$t(\text{sec.})$ ②	$t_1(\text{sec.})$ ③	Reflow cycle
$\Phi 12.5$ – $\Phi 18$	240	230	60	30	1

- ① Peak temperature
- ② The duration over  $200^{\circ}\text{C}$  (max.)
- ③ The duration over  $T_1^{\circ}\text{C}$
- Please contact us if capacitors are subject to the conditions other than the allowable range of reflow.

## X-ON Electronics

Largest Supplier of Electrical and Electronic Components

*Click to view similar products for [Aluminium Electrolytic Capacitors - Radial Leaded](#) category:*

*Click to view products by [Aihua](#) manufacturer:*

Other Similar products are found below :

[LXY50VB4.7M-5X11](#) [RFO-100V471MJ7P#](#) [ECE-A1EGE220](#) [B41041A2687M8](#) [B41041A7226M8](#) [B41044A7157M6](#)  
[EKXG201EC3101ML20S](#) [EKZM160ETD471MHB5D](#) [NCD681K10KVY5PF](#) [NEV1000M25EF-BULK](#) [NEV100M35DC](#) [NEV100M63DE](#)  
[NEV220M25DD-BULK](#) [NEV.33M100AA](#) [NEV4700M50HB](#) [NEV.47M100AA](#) [NEVH1.0M250AB](#) [NEVH3.3M250BB](#) [NEVH3.3M450CC](#)  
[KM4700/16](#) [KME50VB100M-8X11.5](#) [SG220M1CSA-0407](#) [ES5107M016AE1DA](#) [ESMG160ETD102MJ16S](#) [ESX472M16B](#)  
[SZ010M1500A5S-1015](#) [227RZS050M](#) [476CKH100MSA](#) [UVX1V101KPA1FA](#) [UVX1V222MHA1CA](#) [KME25VB100M-6.3X11](#)  
[VTL100S10](#) [VTL470S10](#) [VTL470S16A](#) [511D336M250EK5D](#) [052687X](#) [ECE-A1CF471](#) [EKMA500ELL4R7ME07D](#) [NRE-](#)  
[S560M16V6.3X7TBSTF](#) [RGA221M1CTA-0611G](#) [ERZA630VHN182UP54N](#) [UPL1A331MPH](#) [SK035M0100AZS-0611](#) [MAL214658821E3](#)  
[NEV1000M6.3DE](#) [NEV100M16CB](#) [NEV100M50DD-BULK](#) [NEV2200M16FF](#) [NEV220M50EE](#) [NEV2.2M50AA](#)