

Series AM15EW-Z

15 Watt | DC-DC Converter

FEATURES:



- RoHS compliant
- Efficiency up to 86%
- Wide 4:1 input range
- Continuous Short Circuit Protection
- Low ripple and noise
- Remote on/off control
- Input/Output Isolation 1500VDC
- Operating temperature -40°C to + 85°C

Models Single output



Model	Input Voltage (V)	Output Voltage (V)	Output Current max (A)	Capacitive load (μF)	Efficiency (%)
AM15EW-2403SZ	9-36	3.3	3	3300	80
AM15EW-2405SZ	9-36	5	3	3300	83
AM15EW-2412SZ	9-36	12	1.25	680	85
AM15EW-2415SZ	9-36	15	1	470	86
AM15EW-4803SZ	18-72	3.3	3	3300	80
AM15EW-4805SZ	18-72	5	3	3300	83
AM15EW-4812SZ	18-72	12	1.25	680	85
AM15EW-4815SZ	18-72	15	1	470	86

Add suffix "-K" for optional heatsink

Models Dual output

Model	Input Voltage (V)	Output Voltage (V)	Output Current max (A)	Capacitive load (μF)	Efficiency (%)
AM15EW-2405DZ	9-36	±5	±1.5	±2200	83
AM15EW-2412DZ	9-36	±12	±0.625	±470	85
AM15EW-2415DZ	9-36	±15	±0.5	±330	86
AM15EW-4805DZ	18-72	±5	±1.5	±2200	83
AM15EW-4812DZ	18-72	±12	±0.625	±470	85
AM15EW-4815DZ	18-72	±15	±0.5	±330	86

Add suffix "-K" for optional heatsink

Input Specifications

Parameters	Nominal	Typical	Maximum	Units
Voltage range	24	9-36		VDC
	48	18-72		VDC
Filter	π (Pi) Network			
Remote ON/OFF Control	ON -2.5 to 5.5VDC (or open) ; OFF - 0 to 0.8VDC or short pin 2 to pin 1; OFF idle current - 2.5mA			
Input reflected ripple current		20		mA p-p
Start up time		20		ms
Absolute Maximum Rating	24 Vin	> -0.7	50	VDC
	48 Vin	> -0.7	100	VDC
Peak Input Voltage time			100	ms
Under Voltage Lockout	24 Vin on/off	8.6/8		VDC
	48 Vin on/off	16/14		VDC

Isolation Specifications

Parameters	Conditions	Typical	Rated	Units
Tested I/O voltage	60 sec		1500	VDC
Case/ Input & Output Resistance		1000		VDC
Resistance		> 1000		MOhm
Capacitance		1200		pF

Output Specifications

Parameters	Conditions	Typical	Maximum	Units
Voltage accuracy			±1	%
Voltage balance*	Dual Output	±5		%
Short Circuit protection		Continuous		
Short Circuit restart		Auto Recovery		
Over current protection		140		% of Iout max
Line voltage regulation	HL-LL		±0.5	%
Load voltage regulation	0-100% load		±1.0	%
Temperature coefficient		±0.02		%/°C
Ripple & Noise**	At 20Mhz bandwidth		75	mV p-p
Start up time		20		ms

* One of the outputs is at 100% load while the other output is at 25% to 100% load.

** Measured at 20MHz bandwidth with a 1uF ceramic capacitor.

General Specifications

Parameters	Conditions	Typical	Maximum	Units
Switching frequency	100% load , Variable	300		KHz
Operating temperature	Derating above 60°C	-40 to +85		°C
Storage temperature		-40 to +125		°C
Maximum Case temperature			100	°C
Derating	With heatsink, 60 to 85°C	2.5		%/°C
	Without heatsink, 70 to 85°C	3.33		%/°C
Cooling		Free air convection		
Humidity			95	%
Case material		Nickel coated copper		
Weight	Regular models	31		g
	Optional -K Models	42.3		g
Dimensions (L x W x H)	Regular models	2.00 x 1.00 x 0.40inches	50.80 x 25.40 x 10.16mm	
	Optional -K models	2.00 x 1.00 x 0.64inches	50.80 x 25.40 x 16.30mm	
MTBF		>1 121 000 hrs (MIL-HDBK -217F, Ground Benign, t=+25°C)		

NOTE: All specifications in this datasheet are measured at an ambient temperature of 25°C, humidity<75%, nominal input voltage and at rated output load unless otherwise specified.

Safety Specifications

Standards	
Agency Approvals	CE, cULus(with exception of " -K " models)
Standards	UL62368-1
	EN55032 Class A with the recommended EMC circuit
	IEC61000-4-2, Perf. Criteria B
	IEC61000-4-3, Perf. Criteria A
	IEC61000-4-4, Perf. Criteria A
	IEC61000-4-5, Perf. Criteria A (external 220uF/100V cap required)
	IEC61000-4-6, Perf. Criteria A
	IEC61000-4-8, Perf. Criteria A

Pin Out Specifications

Pin	Single	Dual
1	On/Off Control	On/Off Control
2	-V Input	-V Input
3	+V Input	+V Input
4	-V Output	-V Output
5	No Pin	Common
6	+V Output	+V Output

Dimensions

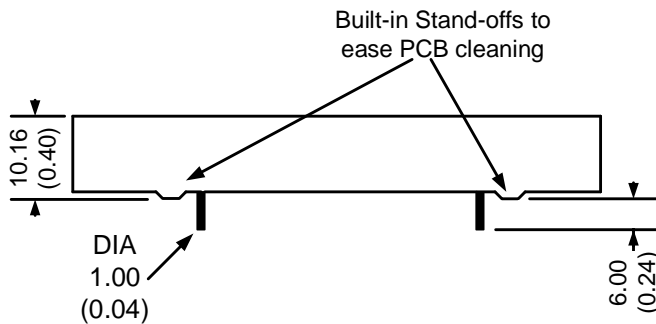
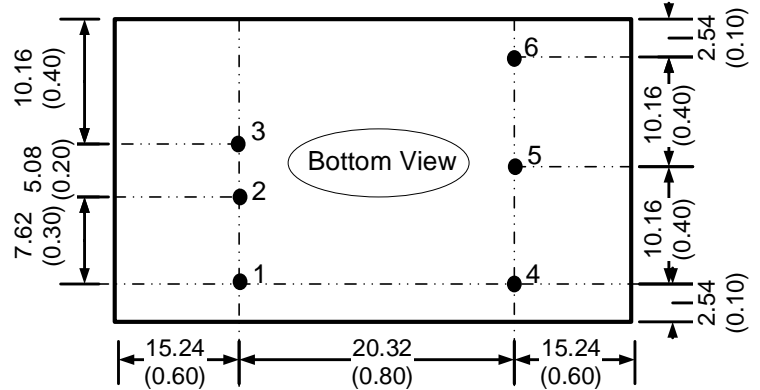
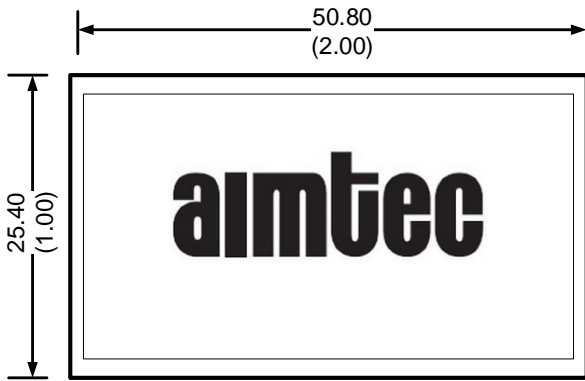

All dimensions are typical in millimeters (inches)
Pin Diameter: 1.00 ± 0.05 (0.04 ± 0.002)
Pin Pitch And Length Tolerance: ± 0.35 (± 0.014)
Case Tolerance: ± 0.5 (± 0.02)

Dimensions with Optional Heatsink

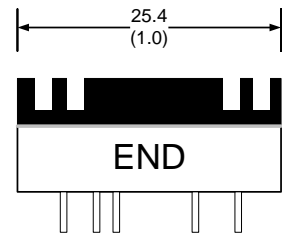
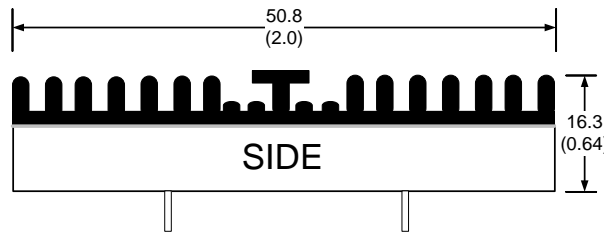

Notes: Add "-K" suffix for ordering, heatsink is affixed with thermally dissipative adhesive tape.
See derating graph for temperature performance. Heatsink material is anodized (black) aluminum, adds weight 11.2g to total mass (42.2g). Thermal impedance of converter is: with heatsink 10°C/W and 12°C/W without heatsink.

Derating

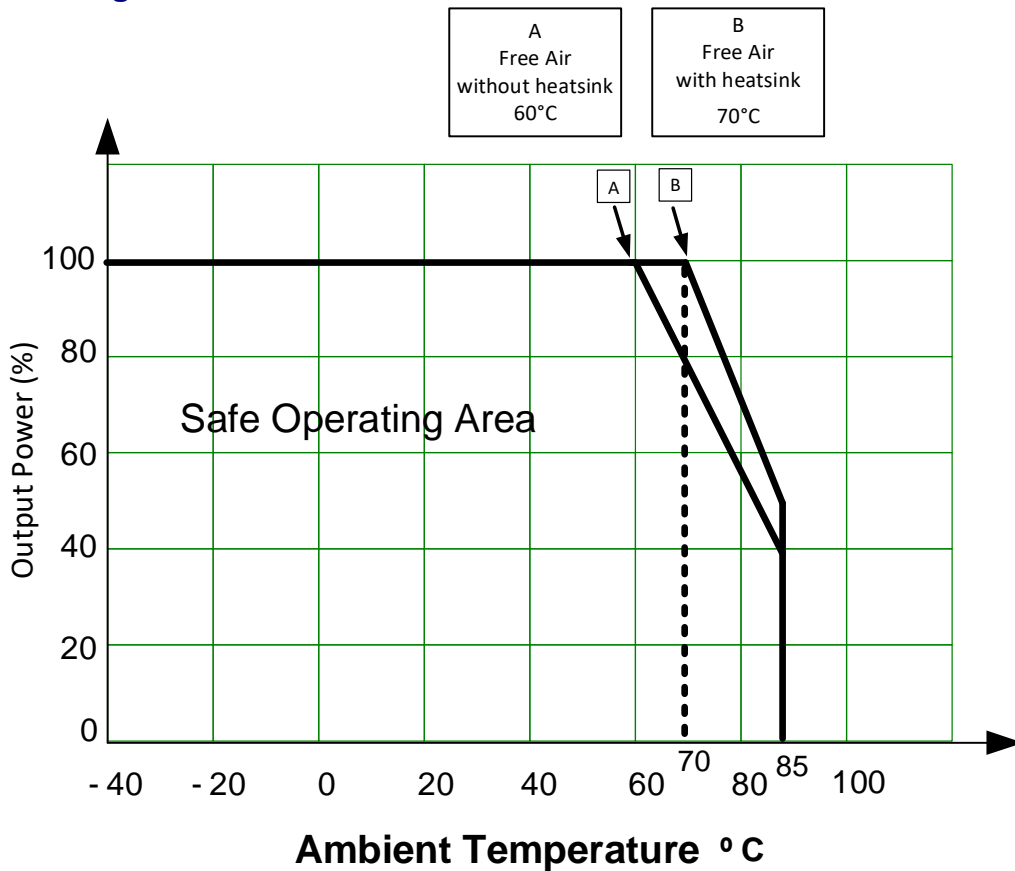

Extended temperature performance can be achieved with optional heat sink. (add suffix “-K” to part number)

Test Circuit
Conducted Emissions:

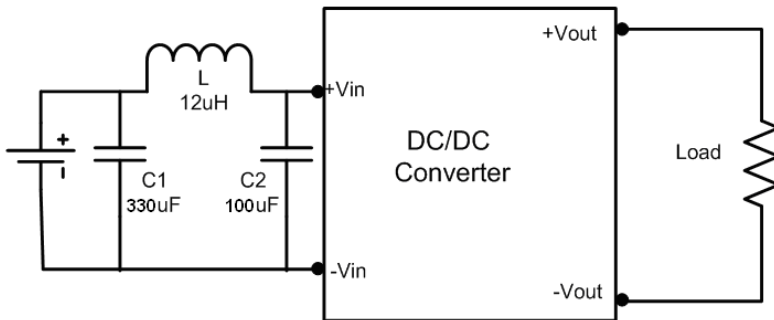

NOTE: 1. Datasheets are updated as needed and as such, specifications are subject to change without notice. Once printed or downloaded, datasheets are no longer controlled by Aimtec; refer to www.aimtec.com for the most current product specifications. 2. Product labels shown, including safety agency certifications on labels, may vary based on the date manufactured. 3. Mechanical drawings and specifications are for reference only. 4. All specifications are measured at an ambient temperature of 25°C, humidity<75%, nominal input voltage and at rated output load unless otherwise specified. 5. Aimtec may not have conducted destructive testing or chemical analysis on all internal components and chemicals at the time of publishing this document. CAS numbers and other limited information are considered proprietary and may not be available for release. 6. This product is not designed for use in critical life support systems, equipment used in hazardous environments, nuclear control systems or other such applications which necessitate specific safety and regulatory standards other than the ones listed in this datasheet. 7. Warranty is in accordance with Aimtec's standard Terms of Sale available at www.aimtec.com.

X-ON Electronics

Largest Supplier of Electrical and Electronic Components

Click to view similar products for [Isolated DC/DC Converters](#) category:

Click to view products by [Aimtec](#) manufacturer:

Other Similar products are found below :

[PSL486-7LR](#) [Q48T30020-NBB0](#) [18362](#) [JAHW100Y1](#) [SPB05C-12](#) [SQ24S15033-PS0S](#) [18952](#) [19-130041](#) [CE-1003](#) [CE-1004](#) [MAU228](#) [J80-0041NL](#) [DFC15U48D15](#) [XGS-1205](#) [SPB05B-15](#) [L-DA20](#) [DCG40-5G](#) [XKS-2405](#) [DPA423R](#) [VI-N61-CM](#) [VI-R5022-EXWW](#) [PSC128-7iR](#) [RPS8-350ATX-XE](#) [vi-m13-cw-03](#) [VI-LN2-EW](#) [AK-1615-7R](#) [VI-L52-EW](#) [VI-L53-CV](#) [VI-LC63-EV](#) [AM2D-051212DZ](#) [24IBX15-50-0ZG](#) [HZZ01204-G](#) [SPU02L-09](#) [SPU02M-09](#) [SPU02N-09](#) [QUINT4-BUFFER/24DC/40](#) [QUINT4-CAP/24DC/5/4KJ](#) [VEFT1-S12-S12-SMT](#) [73-551-5039I](#) [DFC15U48D15G](#) [PV40-29B24](#) [SEN-6471-1EM](#) [URF4824QB-150WHR3](#) [AHV2815DF/HBB](#) [MI-LC21-IX](#) [150035222](#) [PAH-48/8.5-D48NB1-C](#) [BM3020-7A](#) [QRS2050P025R06](#) [RJ-0509S](#)