



FEATURES:

- SMD Package
- Single Output Models
- Low Ripple and Noise
- Industry Standard Pinout
- Input / Output Isolation 1500 & 3000 VDC
- Operating Temperature -40°C to +105°C
- RoHS Compliant
- Continuous Short Circuit Protection ‡

Models

Single output



Model	Input Voltage (V)	Output Voltage (V)	Output Current Max / Min (mA)	Isolation (VDC)	Input Current Max No Load (mA)		Max Capacitive Load (µF)	Efficiency (%)
AM1LS-0303S-NZ	2.97-3.63	3.3	303 / 30	1500	415	25	220	73
AM1LS-0305S-NZ	2.97-3.63	5	200 / 20	1500	388	25	220	78
AM1LS-0503S-NZ	4.5-5.5	3.3	303 / 30	1500	263	20	220	76
AM1LS-0505S-NZ	4.5-5.5	5	200 / 20	1500	250	20	220	80
AM1LS-0509S-NZ	4.5-5.5	9	111 / 12	1500	250	20	220	80
AM1LS-0512S-NZ	4.5-5.5	12	84 / 9	1500	250	20	220	80
AM1LS-0515S-NZ	4.5-5.5	15	67 / 7	1500	250	20	220	80
AM1LS-0524S-NZ ‡	4.5-5.5	24	42 / 4	1500	250	20	220	80
AM1LS-1203S-NZ	10.8-13.2	3.3	303 / 30	1500	111	15	220	75
AM1LS-1205S-NZ	10.8-13.2	5	200 / 20	1500	104	15	220	80
AM1LS-1209S-NZ	10.8-13.2	9	111 / 12	1500	104	15	220	80
AM1LS-1212S-NZ	10.8-13.2	12	84 / 9	1500	103	15	220	81
AM1LS-1215S-NZ	10.8-13.2	15	67 / 7	1500	103	15	220	81
AM1LS-1224S-NZ	10.8-13.2	24	42 / 4	1500	103	15	220	81
AM1LS-1515S-NZ	13.5-16.5	15	67 / 7	1500	82	10	220	81
AM1LS-2405S-NZ	21.6-26.4	5	200 / 20	1500	52	7	220	80
AM1LS-2409S-NZ	21.6-26.4	9	111 / 12	1500	52	7	220	80
AM1LS-2415S-NZ	21.6-26.4	15	67 / 7	1500	51	7	220	81
AM1LS-2424S-NZ	21.6-26.4	24	42 / 4	1500	51	7	220	81
AM1LS-0303SH30-NZ	2.97-3.63	3.3	303 / 30	3000	415	25	220	73
AM1LS-0305SH30-NZ	2.97-3.63	5	200 / 20	3000	388	25	220	78
AM1LS-0503SH30-NZ	4.5-5.5	3.3	303 / 30	3000	263	20	220	76
AM1LS-0505SH30-NZ	4.5-5.5	5	200 / 20	3000	250	20	220	80
AM1LS-0509SH30-NZ	4.5-5.5	9	111 / 12	3000	250	20	220	80
AM1LS-0512SH30-NZ	4.5-5.5	12	84 / 9	3000	250	20	220	80
AM1LS-0515SH30-NZ	4.5-5.5	15	67 / 7	3000	250	20	220	80
AM1LS-0524SH30-NZ ‡	4.5-5.5	24	42 / 4	3000	250	20	220	80
AM1LS-1203SH30-NZ	10.8-13.2	3.3	303 / 30	3000	111	15	220	75
AM1LS-1205SH30-NZ	10.8-13.2	5	200 / 20	3000	104	15	220	80
AM1LS-1209SH30-NZ	10.8-13.2	9	111 / 12	3000	104	15	220	80
AM1LS-1212SH30-NZ	10.8-13.2	12	84 / 9	3000	103	15	220	81
AM1LS-1215SH30-NZ	10.8-13.2	15	67 / 7	3000	103	15	220	81
AM1LS-1224SH30-NZ	10.8-13.2	24	42 / 4	3000	103	15	220	81
AM1LS-2405SH30-NZ	21.6-26.4	5	200 / 20	3000	52	7	220	80
AM1LS-2409SH30-NZ	21.6-26.4	9	111 / 12	3000	52	7	220	80
AM1LS-2415SH30-NZ	21.6-26.4	15	67 / 7	3000	51	7	220	81
AM1LS-2424SH30-NZ	21.6-26.4	24	42 / 4	3000	51	7	220	81

‡ Please note Aimtec product change announcement located here www.aimtec.com/news for product specification changes effective February 7th 2015.

Models
Dual output

Model	Input Voltage (V)	Output Voltage (V)	Output Current Max / Min (mA)	Isolation (VDC)	Input Current Max No Load (mA)		Max Capacitive Load(μF)	Efficiency (%)
AM1LS-0305D-NZ	2.97-3.63	±5	±100 / ±10	1500	415	25	100	78
AM1LS-0312D-NZ	2.97-3.63	±12	±42 / ±5	1500	388	25	100	80
AM1LS-0315D-NZ	2.97-3.63	±15	±33 / ±3	1500	263	20	100	80
AM1LS-0505D-NZ	4.5-5.5	±5	±100 / ±10	1500	250	20	100	80
AM1LS-0509D-NZ	4.5-5.5	±9	±56 / ±6	1500	250	20	100	80
AM1LS-0512D-NZ	4.5-5.5	±12	±42 / ±5	1500	250	20	100	81
AM1LS-0515D-NZ	4.5-5.5	±15	±33 / ±3	1500	250	20	100	81
AM1LS-0524D-NZ †	4.5-5.5	±24	±21 / ±2	1500	250	20	100	81
AM1LS-1205D-NZ	10.8-13.2	±5	±100 / ±10	1500	111	15	100	75
AM1LS-1209D-NZ	10.8-13.2	±9	±56 / ±6	1500	104	15	100	80
AM1LS-1212D-NZ	10.8-13.2	±12	±42 / ±5	1500	104	15	100	80
AM1LS-1215D-NZ	10.8-13.2	±15	±33 / ±3	1500	103	15	100	81
AM1LS-1224D-NZ	10.8-13.2	±24	±21 / ±2	1500	103	15	100	81
AM1LS-2405D-NZ	21.6-26.4	±5	±100 / ±10	1500	82	10	100	82
AM1LS-2409D-NZ	21.6-26.4	±9	±56 / ±6	1500	52	7	100	82
AM1LS-2412D-NZ	21.6-26.4	±12	±42 / ±5	1500	52	7	100	82
AM1LS-2415D-NZ	21.6-26.4	±15	±33 / ±3	1500	51	7	100	82
AM1LS-2424D-NZ	21.6-26.4	±24	±21 / ±2	1500	51	7	100	82
AM1LS-0505DH30-NZ	4.5-5.5	±5	±100 / ±10	3000	250	20	100	80
AM1LS-0509DH30-NZ	4.5-5.5	±9	±56 / ±6	3000	250	20	100	80
AM1LS-0512DH30-NZ	4.5-5.5	±12	±42 / ±5	3000	250	20	100	81
AM1LS-0515DH30-NZ	4.5-5.5	±15	±33 / ±3	3000	250	20	100	81
AM1LS-0524DH30-NZ †	4.5-5.5	±24	±21 / ±2	3000	250	20	100	81
AM1LS-1205DH30-NZ	10.8-13.2	±5	±100 / ±10	3000	111	15	100	80
AM1LS-1209DH30-NZ	10.8-13.2	±9	±56 / ±6	3000	104	15	100	80
AM1LS-1212DH30-NZ	10.8-13.2	±12	±42 / ±5	3000	104	15	100	81
AM1LS-1215DH30-NZ	10.8-13.2	±15	±33 / ±3	3000	103	15	100	81
AM1LS-1224DH30-NZ	10.8-13.2	±24	±21 / ±2	3000	103	15	100	81
AM1LS-2405DH30-NZ	21.6-26.4	±5	±100 / ±10	3000	82	10	100	82
AM1LS-2409DH30-NZ	21.6-26.4	±9	±56 / ±6	3000	52	7	100	82
AM1LS-2412DH30-NZ	21.6-26.4	±12	±42 / ±5	3000	52	7	100	82
AM1LS-2415DH30-NZ	21.6-26.4	±15	±33 / ±3	3000	51	7	100	82
AM1LS-2424DH30-NZ	21.6-26.4	±24	±21 / ±2	3000	51	7	100	82

NOTE 1: Add suffix "TR" to a part number when ordering in tape and reel package

NOTE: All specifications in this datasheet are measured at an ambient temperature of 25°C, humidity<75%, nominal input voltage and at rated output load unless otherwise specified.

Input Specifications

Parameters	Nominal	Typical	Maximum	Units
Voltage Range	3	2.97-3.63		VDC
	5	4.5-5.5		
	12	10.8-13.2		
	15	13.5-16.5		
	24	21.6-26.4		
Absolute Max Input Voltage (1 sec max)	3 Vin		5	VDC
	5 Vin		9	
	12 Vin		18	
	15 Vin		21	
	24 Vin		30	
Filter		Capacitor		

Isolation Specifications

Parameters	Conditions	Typical	Maximum	Units
Tested I/O Voltage	60 sec	1500 models 3000 Models		VDC
Resistance	500VDC	>1000		MOhm
Capacitance		20		pF

Output Specifications

Parameters	Conditions	Typical	Maximum	Units
Voltage Accuracy	100% load (see tolerance chart)	±2.5		%
Short Circuit Protection		Continuous ‡		
Short Circuit Restart		Auto-Recovery		
Line Voltage Regulation	For ±1% of Vin 3.3V models only	±1.2 ±1.5		% of Vin
Load Voltage Regulation (10% - 100% Load)	3.3V	18		%
	5 V	12		
	9 V	8		
	12 V	7		
	15 V	6		
	24 V	5		
Temperature Coefficient	100% load	±0.03		%/°C
Ripple & Noise		60		mV p-p

General Specifications

Parameters	Conditions	Typical	Maximum	Units
Switching frequency	100% load	100	300	KHz
Operating temperature	With derating above +100		-40 to +105	°C
Storage temperature		-55 to +125		°C
Cooling		Free air convection		
Storage Humidity	Non Condensing		95	% RH
Case material		Epoxy resin (UL94-V0)		
Weight		Single 1.5 Dual 1.8		g
Dimensions (L x W x H)		Single Output 0.50 x 0.44 x 0.28 inches Dual Output 0.60 x 0.44 x 0.28 inches	12.70 x 11.20 x 7.25mm 15.24 x 11.20 x 7.25 mm	
MTBF		>3500Khrs (MIL-HDBK -217F, Ground Benign, t=+25°C)hours		
Maximum soldering temperature	1.5mm from case for 10 sec		300	°C
Maximum case temperature			130	°C

Safety Specifications

Parameters	
Agency approvals	cULus (without 15V input and without dual output models)
Standards	UL 60950-1

Pin Out Specifications and Dimensions

Pin	Single
1	- V Input
2	+ V Input
3	No Pin
4	.-V Output
5	+V Output
6	No Pin
7	No Pin
8	N.C.

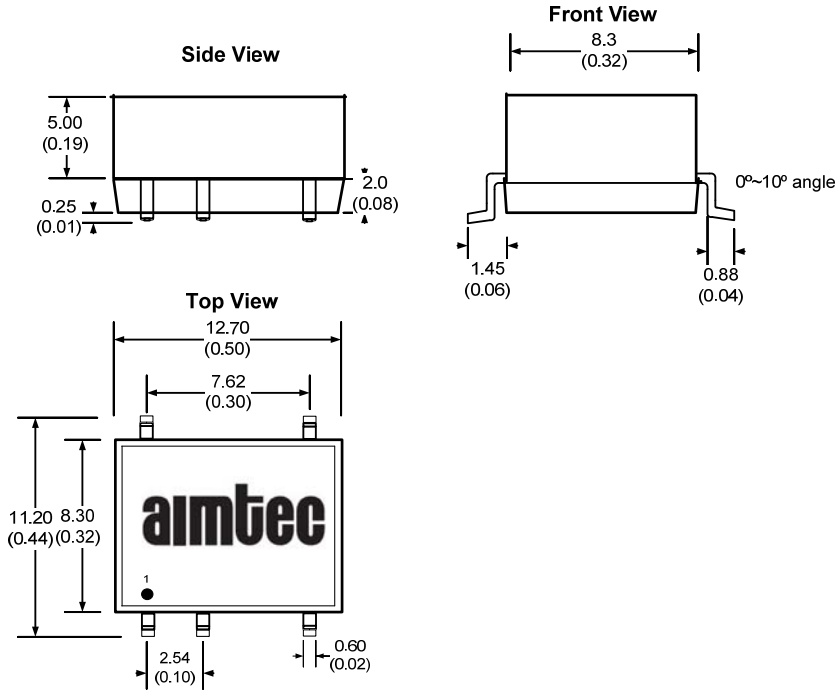

Pin	Dual Output Models
1	-V Input
2	+V Input
3	No Pin
4	Common
5	-V Output
6	No Pin
7	+V Output
8	No Pin
9	No Pin
10	N.C.

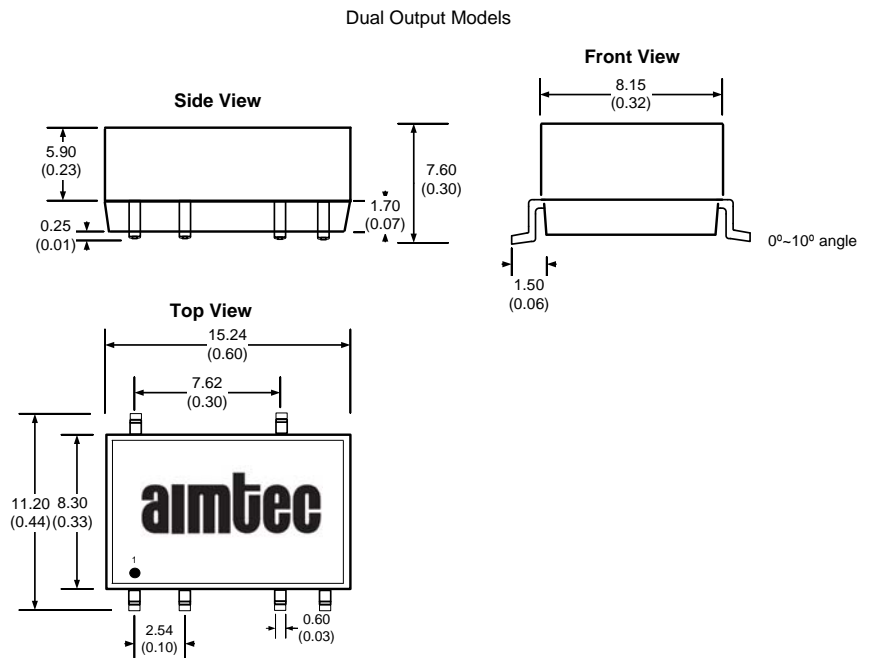

EMI Recommended Circuit (Class B) Input Reflected Ripple Current Test Circuit

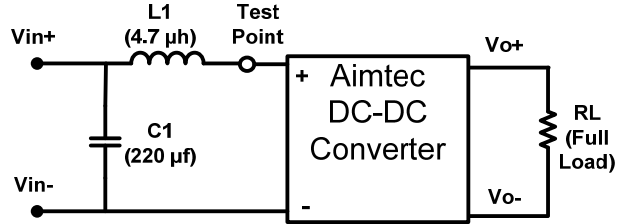
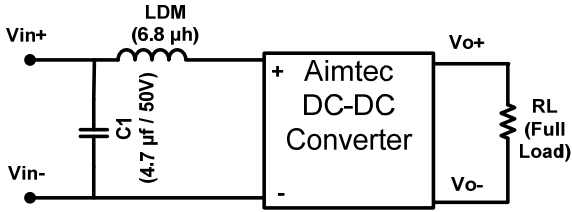

* Tested at full load, and nominal input

Load Accuracy Tolerance Graph

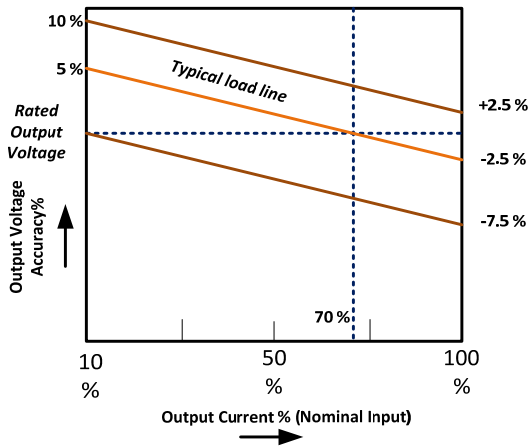

Derating

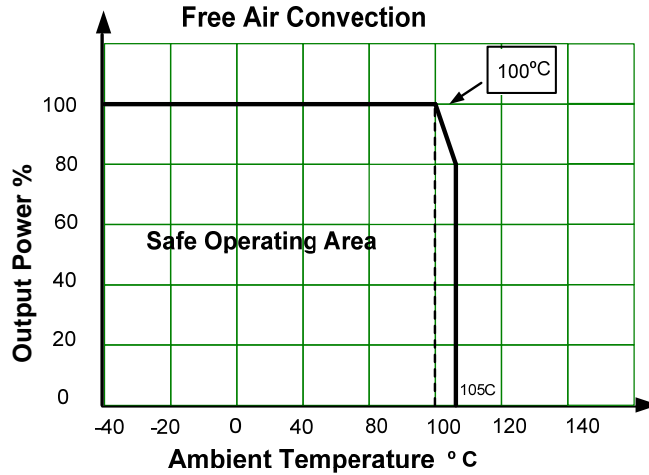

Typical Efficiency vs. Loading

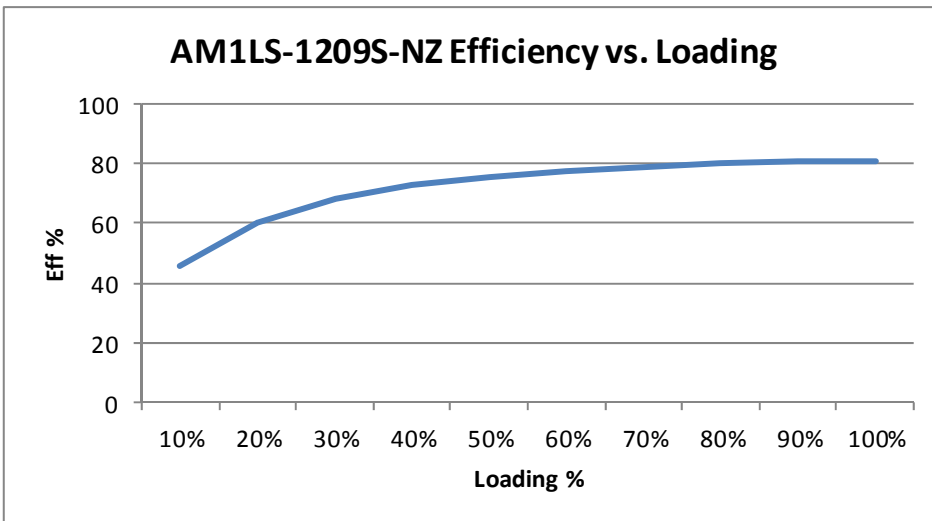
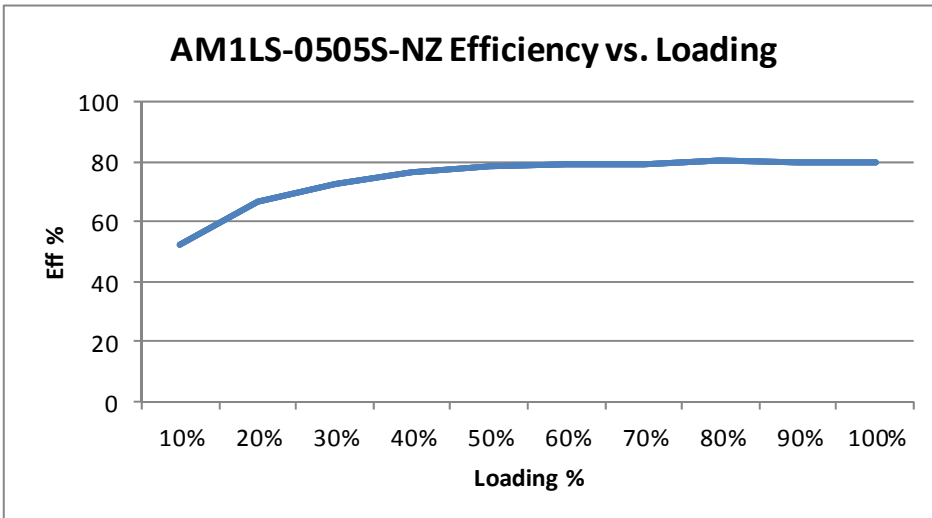
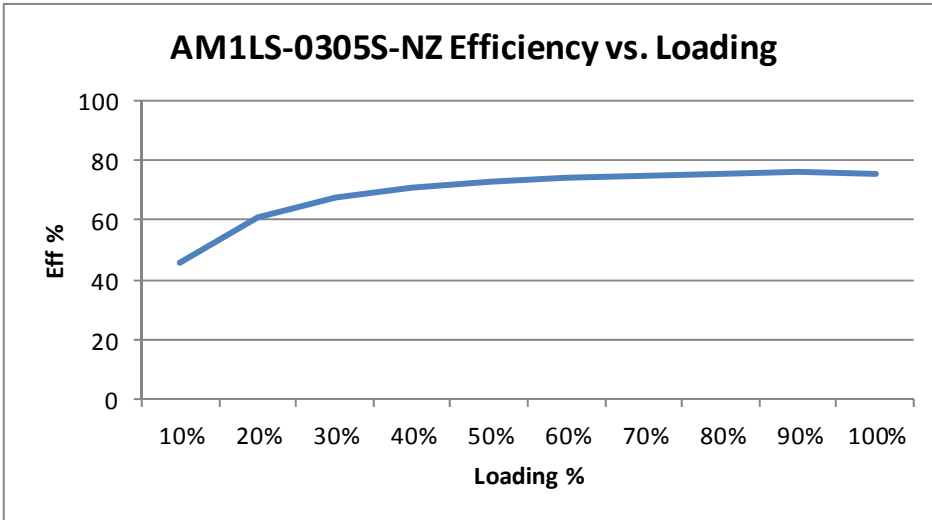

Recommended Circuits

Capacitor selection Table

Vin	C1	Single VDC	C2	Dual VDC	C2/C3
3.3	4.7 μ F	3.3 V	10 μ F	\pm 3.3	4.7 μ F
5	4.7 μ F	5V	10 μ F	\pm 5V	4.7 μ F
		9 V	4.7 μ F	\pm 9V	2.2 μ F
12	2.2 μ F	12 V	2.2 μ F	\pm 12 V	1 μ F
15	2.2 μ F	15 V	1 μ F	\pm 15 V	0.47 μ F
24	1 μ F	24V	0.47 μ F	\pm 24 V	0.47 μ F

- 1) Ensure output load of Min 10%, or specifications may not be met
- 2) Under normal operation, there is no protection for overload condition
- 3) Converter may exhibit start up delay if capacitive load exceeds recommended
- 4) Ceramic or electrolytic type capacitors are recommended, tantalum type may damage converter
- 5) Parallel connections, or hot swapping is not recommended

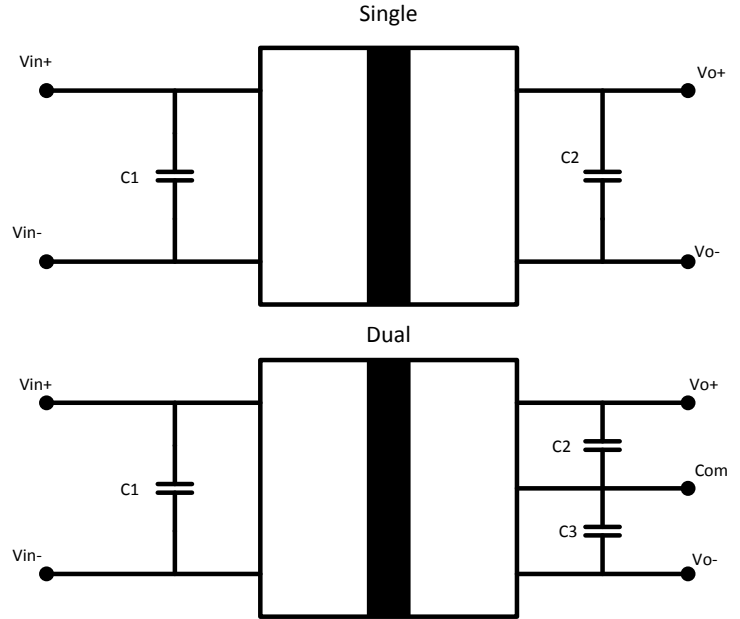

NOTE: 1. Datasheets are updated as needed and as such, specifications are subject to change without notice. Once printed or downloaded, datasheets are no longer controlled by Aimtec; refer to www.aimtec.com for the most current product specifications. 2. Product labels shown, including safety agency certifications on labels, may vary based on the date manufactured. 3. Mechanical drawings and specifications are for reference only. 4. All specifications are measured at an ambient temperature of 25°C, humidity < 75%, nominal input voltage and at rated output load unless otherwise specified. 5. Aimtec may not have conducted destructive testing or chemical analysis on all internal components and chemicals at the time of publishing this document. CAS numbers and other limited information are considered proprietary and may not be available for release. 6. This product is not designed for use in critical life support systems, equipment used in hazardous environments, nuclear control systems or other such applications which necessitate specific safety and regulatory standards other than the ones listed in this datasheet. 7. Warranty is in accordance with Aimtec's standard Terms of Sale available at www.aimtec.com.

X-ON Electronics

Largest Supplier of Electrical and Electronic Components

Click to view similar products for [Isolated DC/DC Converters](#) category:

Click to view products by [Aimtec](#) manufacturer:

Other Similar products are found below :

[ESM6D044440C05AAQ](#) [FMD15.24G](#) [PSL486-7LR](#) [PSR152.5-7IR](#) [Q48T30020-NBB0](#) [AVO240-48S12B-6L](#) [AVO250-48S28B-6L](#) [NAN-0505](#) [HW-L16D](#) [JAHW100Y1](#) [217-1617-001](#) [22827](#) [SPB05C-12](#) [SQ24S15033-PS0S](#) [18952](#) [19-130041](#) [CE-1003](#) [CE-1004](#) [GQ2541-7R](#) [PSE1000DCDC-12V](#) [RDS180245](#) [MAU228](#) [419-2065-201](#) [449-2075-101](#) [TME 0303S](#) [TME 0505S](#) [TME 1205S](#) [TME 1212S](#) [TME 2405S](#) [TME 2412S](#) [V300C24C150BG](#) [419-2062-200](#) [419-2063-401](#) [419-2067-101](#) [419-2067-501](#) [419-2068-001](#) [DCG40-5G](#) [DFC15U48D15](#) [449-2067-000](#) [XGS-0512](#) [XGS-1205](#) [XGS-1212](#) [XGS-2412](#) [XGS-2415](#) [XKS-1215](#) [033456](#) [NCT1000N040R050B](#) [SPB05B-15](#) [SPB05C-15](#) [TME 0509S](#)