

Click to  
**ORDER**  
samples

AM1SS-JZ

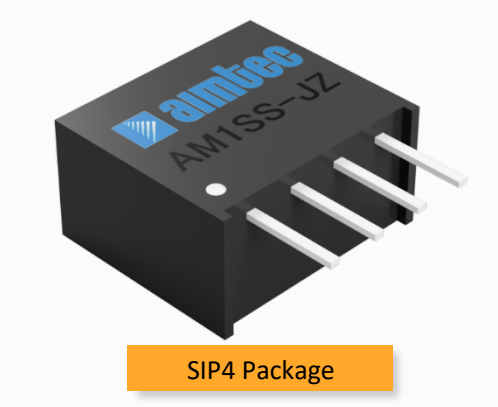

The AM1SS-JZ is a 1W SIP4 DC/DC converter that offers great cost savings thanks to an improved manufacturing process. It also features excellent reliability and performance while offering a standard input voltage range of 5-24VDC as well as an output voltage of 3.3-24V. This compact SIP4 design will surely benefit your new system design.

This new series offers great operating temperatures, from -40 to 105°C with full power up to 85°C. Also, an isolation of 1500VDC for improved reliability and system safety as well as a great 3,500,000h MTBF come standard.

The AM1SS-JZ is suitable for instrumentation, industrial controls, communication and IoT applications.

Features

- High I/O Isolation of 1500VDC
- Continuous Short circuit protection
- Operating Temp: -40 °C to +105 °C
- Industry standard SIP4 pin-out
- Efficiency up to 85%
- Unregulated output

Summary

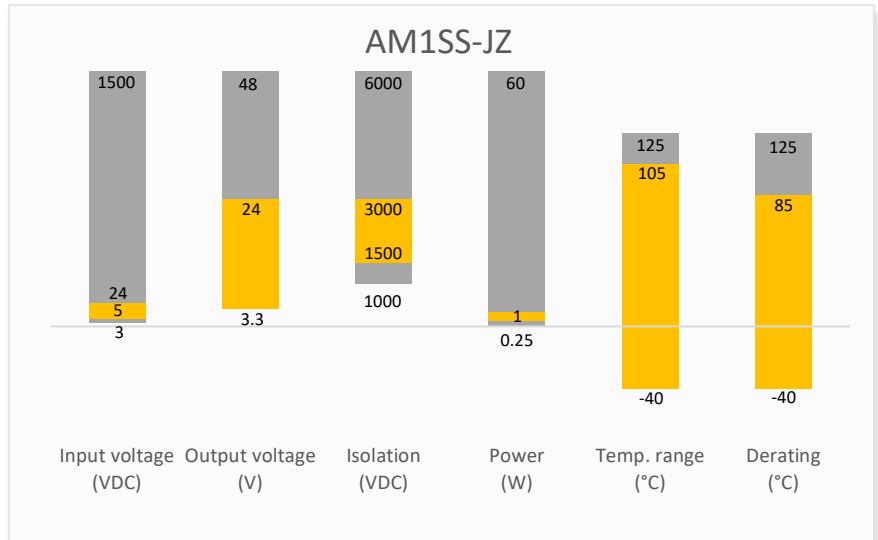

Training



Product Training Video  
(click to open)



Press Release



Coming Soon!

Application Notes

Applications



## Models & Specifications



Single Output							
Model	Input Voltage (VDC)	Output Voltage (VDC)	Input Current Full   No load typ. (mA)	Output Current max   min (mA)*	Isolation (VDC)	Maximum capacitive Load (μF)	Efficiency Typ. (%)
AM1SS-0503SJZ	5 (4.5-5.5)	3.3	270 / 5	303 / 30	1500	2400	74
AM1SS-0505SJZ #	5 (4.5-5.5)	5	270 / 5	200 / 20	1500	2400	82
AM1SS-0509SJZ	5 (4.5-5.5)	9	241 / 12	111 / 12	1500	1000	83
AM1SS-0512SJZ	5 (4.5-5.5)	12	241 / 12	84 / 9	1500	560	83
AM1SS-0515SJZ	5 (4.5-5.5)	15	241 / 18	67 / 7	1500	560	83
AM1SS-0524SJZ	5 (4.5-5.5)	24	241 / 18	42 / 4	1500	220	85
AM1SS-1203SJZ #	12 (10.8-13.2)	3.3	112 / 8	303 / 30	1500	2400	75
AM1SS-1205SJZ #	12 (10.8-13.2)	5	105 / 8	200 / 20	1500	2400	80
AM1SS-1209SJZ #	12 (10.8-13.2)	9	105 / 8	111 / 12	1500	1000	80
AM1SS-1212SJZ #	12 (10.8-13.2)	12	105 / 8	83 / 9	1500	560	80
AM1SS-1215SJZ #	12 (10.8-13.2)	15	103 / 8	67 / 7	1500	560	81
AM1SS-1224SJZ #	12 (10.8-13.2)	24	103 / 8	42 / 5	1500	220	81
AM1SS-1505SJZ #	15 (13.5-16.5)	5	84 / 8	200 / 20	1500	2400	80
AM1SS-1509SJZ #	15 (13.5-16.5)	9	84 / 8	111 / 12	1500	1000	80
AM1SS-1512SJZ #	15 (13.5-16.5)	12	84 / 8	83 / 9	1500	560	80
AM1SS-1515SJZ #	15 (13.5-16.5)	15	83 / 8	67 / 7	1500	560	81
AM1SS-2403SJZ #	24 (21.6-26.4)	3.3	56 / 8	303 / 30	1500	2400	75
AM1SS-2405SJZ #	24 (21.6-26.4)	5	53 / 8	200 / 20	1500	2400	79
AM1SS-2409SJZ #	24 (21.6-26.4)	9	53 / 8	111 / 12	1500	1000	80
AM1SS-2412SJZ #	24 (21.6-26.4)	12	52 / 8	83 / 9	1500	560	81
AM1SS-2415SJZ #	24 (21.6-26.4)	15	52 / 8	67 / 7	1500	560	81
AM1SS-2424SJZ #	24 (21.6-26.4)	24	52 / 8	42 / 5	1500	220	81

\* Performance will be degraded if the load is not within the output current range.

Input Specification				
Parameters	Conditions	Typical	Maximum	Units
Filter	Capacitor			
Absolute maximum rating	Maximum duration 1s, 5Vin	>0.7	9	VDC
	Maximum duration 1s, 12Vin	>0.7	18	VDC
	Maximum duration 1s, 15Vin	>0.7	21	VDC
	Maximum duration 1s, 24Vin	>0.7	30	VDC
Input reflected ripple current	5Vin models	15		mA
	Other models	30		mA

Isolation Specification				
Parameters	Conditions	Typical	Maximum	Units
Tested I/O voltage	60 sec, leakage ≤ 1mA for all models	>1500		VDC
	1 sec, leakage ≤ 1mA for 5Vin models	>3000		VDC
Resistance	500VDC	>1000		MΩ
Capacitance	100kHz/0.1V	20		pF

Output Specification				
Parameters	Conditions	Typical	Maximum	Units
Voltage accuracy	See output voltage tolerance	±5		%
Line regulation	Per 1% Vin change, 3.3Vout models		1.5	%
	Per 1% Vin change, other models		1.2	%
Load regulation	10-100% load, 3.3Vout models		20	%
	10-100% load, 5Vout models		15	%
	10-100% load, other models		10	%
Ripple & Noise*	24Vout models	50	100	mV pk-pk
	other models	30	75	mV pk-pk
Temperature coefficient		±0.02		%/°C

\* Ripple and Noise are measured at 20MHz bandwidth. Please refer to the application note for specific details.

General Specifications				
Parameters	Conditions	Typical	Maximum	Units
Switching frequency	Full load, nominal input, 5Vin models	270		KHz
	Full load, nominal input, other models	260		KHz
Short circuit protection	Continuous, Auto recovery			
Operating temperature	With derating	-40 to +105		°C
Storage temperature		-55 to +125		°C
Case temperature rise	Ambient temperature at 25°C, 5Vin, 3.3Vout models	25		°C
	Ambient temperature at 25°C, 5Vin, other models	15		°C
	Ambient temperature at 25°C, other models	30		°C
Manual soldering temperature	1.5mm away from case, duration ≤ 10sec		300	°C
Cooling	Free air convection			
Humidity	Non-condensing	>5	95	% RH
Vibration	10-150Hz, 5G, 30Min, along all axis, 12/15/24Vin models only			
Case material	Black plastic (flammability to UL 94V-0)			
Weight		1.3		g
Dimensions (L x W x H)		0.46 x 0.24 x 0.40 inches (11.60 x 6.00 x 10.16 mm)		
MTBF	3 500 000 hrs (MIL-HDBK -217F, t=+25°C) / Full Load			

NOTE: All specifications in this datasheet are measured at an ambient temperature of 25°C, humidity<75%, nominal input voltage and at rated output load unless otherwise specified.

Safety Specifications		
Parameters		
Agency approvals	UL 62368-1 (For models marked with # only)	
Standards	Information technology Equipment	Design to meet EN62368-1
	EMC - Conducted and radiated emission	CISPR32 / EN55032, class B with the recommended EMI circuit
	Electrostatic Discharge Immunity	IEC 61000-4-2 Air ±8KV, Contact ±4KV, Criteria B for 5Vin models IEC 61000-4-2 Contact ±6KV, Criteria B for 12/15/24Vin models

Derating

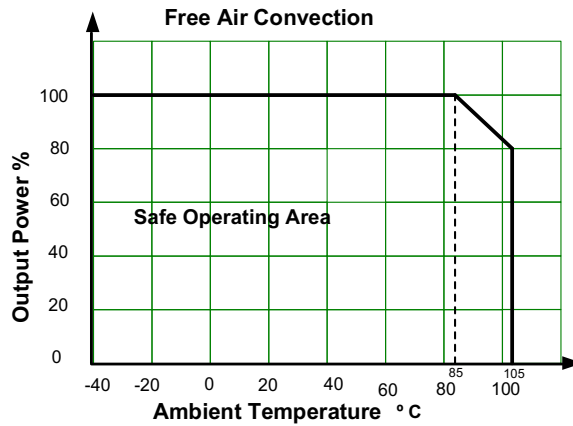

Output voltage tolerance

3.3Vout models

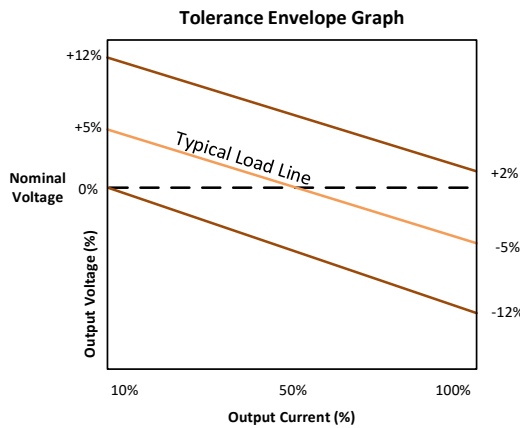

5Vin, 5/9/12/15/24Vout models

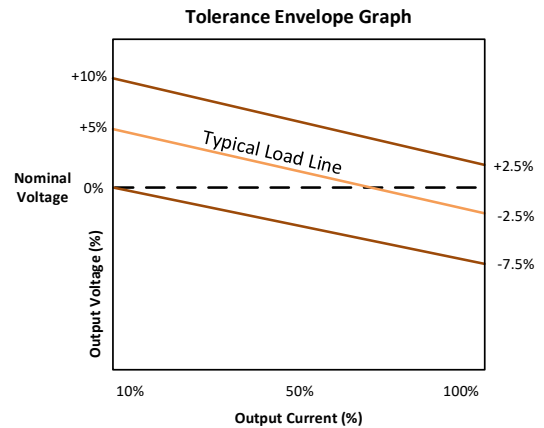

Other models

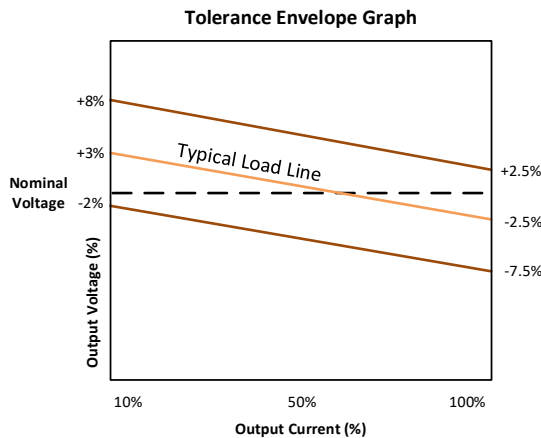

## Typical application circuit

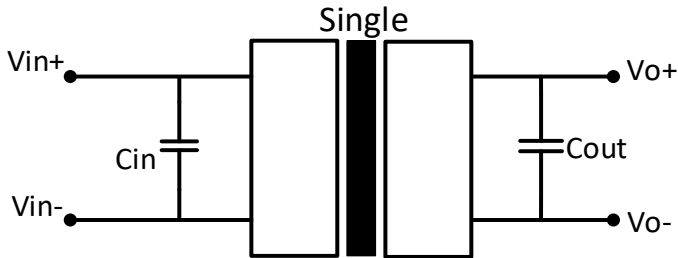

Vin	Cin
5V	4.7 $\mu$ F
12/15V	2.2 $\mu$ F/25V
24V	1 $\mu$ F/50V

Vout	Cout
3.3/5V	10 $\mu$ F/16V
9V	2.2 $\mu$ F/16V
12V	2.2 $\mu$ F/25V
15V	1 $\mu$ F/25V
24V	1 $\mu$ F/50V

## Recommended EMI circuit

### 5Vin models

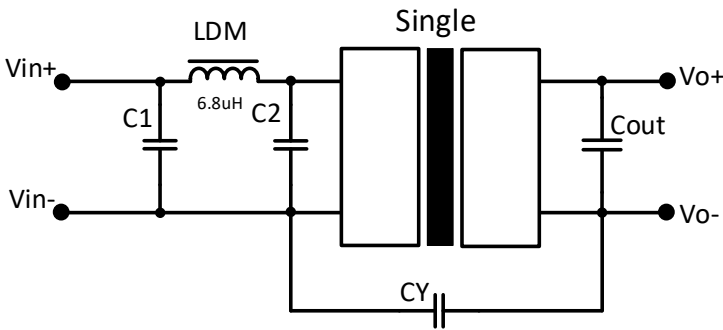

Vout	C1/C2	CY
3.3/5/9V	4.7 $\mu$ F/25V	-
12/15/24V	4.7 $\mu$ F/25V	1nF/4kVdc

### 12/15/24Vin models

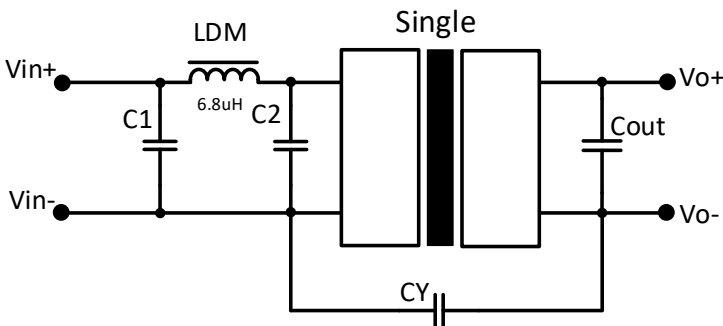

Isolation	C1/C2	CY
1.5KV	4.7 $\mu$ F/50V	270pF/2kVdc

## Dimensions

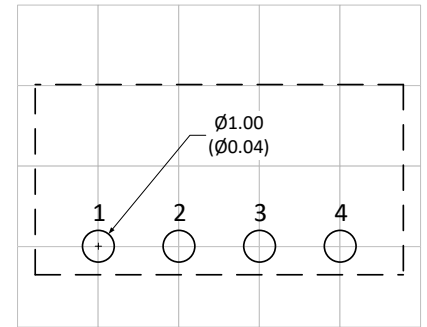
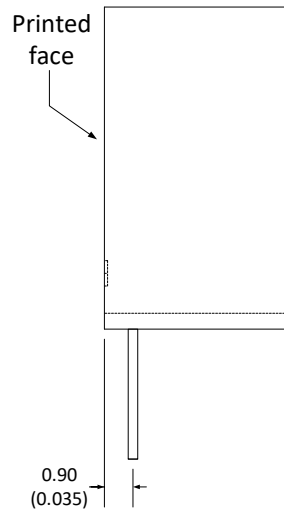
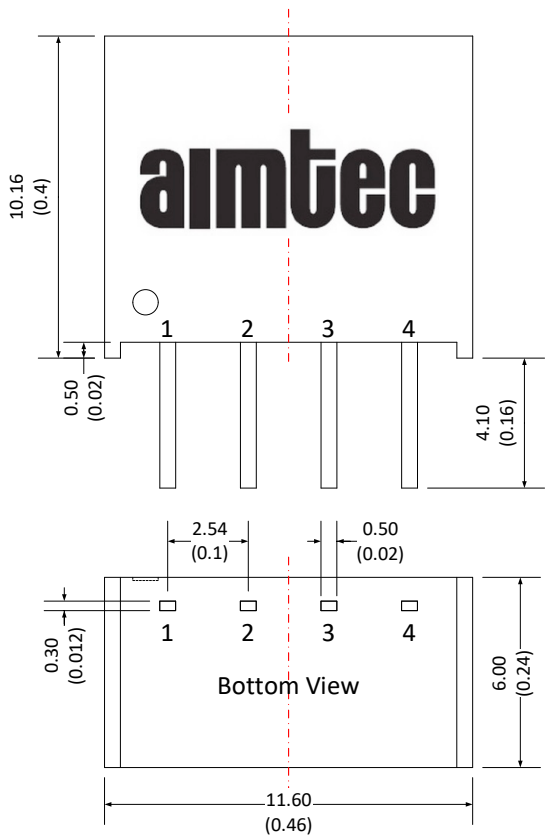

Grid size: 2.54\*2.54mm

**Note:**

Unit: mm(inch)

General tolerance:  $\pm 0.25$  (0.01)

Pin tolerance:  $\pm 0.1$  (0.004)

Pin Out Specifications	
Pin	Single output
1	-V Input
2	+V Input
3	-V Output
4	+V Output

**NOTE:** 1. Datasheets are updated as needed and as such, specifications are subject to change without notice. Once printed or downloaded, datasheets are no longer controlled by Aimtec; refer to [www.aimtec.com](http://www.aimtec.com) for the most current product specifications. 2. Product labels shown, including safety agency certifications on labels, may vary based on the date manufactured. 3. Mechanical drawings and specifications are for reference only. 4. All specifications are measured at an ambient temperature of 25°C, humidity<75%, nominal input voltage and at rated output load unless otherwise specified. 5. Aimtec may not have conducted destructive testing or chemical analysis on all internal components and chemicals at the time of publishing this document. CAS numbers and other limited information are considered proprietary and may not be available for release. 6. This product is not designed for use in critical life support systems, equipment used in hazardous environments, nuclear control systems or other such applications which necessitate specific safety and regulatory standards other than the ones listed in this datasheet. 7. Warranty is in accordance with Aimtec's standard Terms of Sale available at [www.aimtec.com](http://www.aimtec.com).

## X-ON Electronics

Largest Supplier of Electrical and Electronic Components

*Click to view similar products for [Isolated DC/DC Converters](#) category:*

*Click to view products by [Aimtec](#) manufacturer:*

Other Similar products are found below :

[ESM6D044440C05AAQ](#) [FMD15.24G](#) [PSL486-7LR](#) [Q48T30020-NBB0](#) [18362](#) [JAHW100Y1](#) [SPB05C-12](#) [SQ24S15033-PS0S](#) [19-130041](#)  
[CE-1003](#) [GQ2541-7R](#) [RDS180245](#) [MAU228](#) [J80-0041NL](#) [DFC15U48D15](#) [XGS-0512](#) [XGS-1205](#) [XGS-1212](#) [XGS-2412](#) [XGS-2415](#) [XKS-](#)  
[1215](#) [06322](#) [NCT1000N040R050B](#) [SPB05B-15](#) [SPB05C-15](#) [L-DA20](#) [DCG40-5G](#) [QME48T40033-PGB0](#) [XKS-2415](#) [XKS-2412](#) [XKS-1212](#)  
[XKS-1205](#) [XKS-0515](#) [XKS-0505](#) [XGS-2405](#) [XGS-1215](#) [XGS-0515](#) [73-551-5038I](#) [AK1601-9RT](#) [VI-N61-CM](#) [VI-R5022-EXWW](#) [PSC128-](#)  
[7iR](#) [RPS8-350ATX-XE](#) [DAS1004812](#) [PQA30-D24-S24-DH](#) [VI-M5F-CQ](#) [VI-LN2-EW](#) [VI-PJW01-CZY](#) [CK2540-9ERT](#) [AK-1615-7R](#)