

Click to
ORDER
samples

AM2LS-JZ

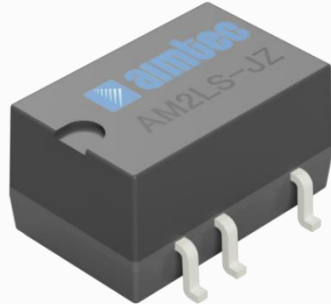

SMD Package

The AM2LS-JZ is a 2W SMD DC/DC converter that offers great cost savings thanks to an improved manufacturing process. It also features excellent reliability and performance while offering a standard input voltage range of 12-24VDC as well as an output voltage of 5-24V. This compact SMD design will surely benefit your new system design.

This new series offers great operating temperatures, from -40 to 105°C with full power up to 71 or 85°C. Also, an isolation of 1500VDC & 3000VDC for improved reliability and system safety as well as a great 3,500,000h MTBF come standard.

The AM2LS-JZ is suitable for instrumentation, industrial controls, communication and IoT applications.

Features

- High I/O Isolation 1500VDC & 3000VDC
- Continuous Short circuit protection
- Operating Temp: -40 °C to +105 °C
- Low profile case height: 7.25mm
- Compact footprint and high-power Density
- Efficiency up to 85%
- Unregulated output



Summary

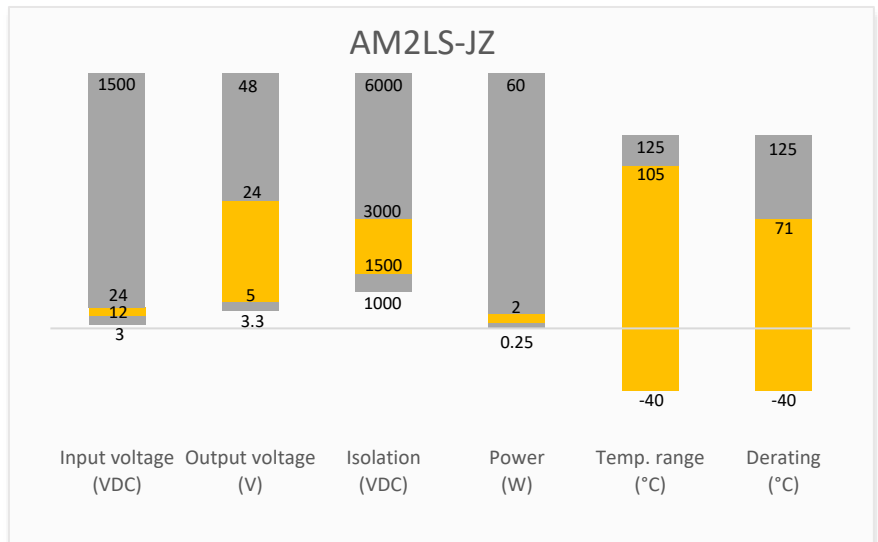

Training

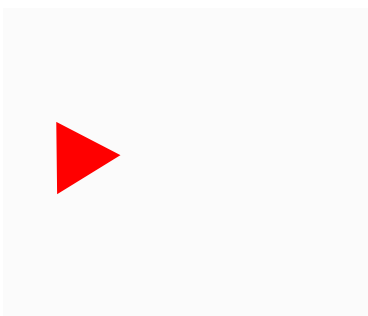

Product Training Video
(click to open)

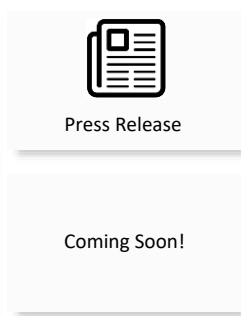

Application Notes

Applications



IoT



Industrial



Telecom



Portable Equipment

Models & Specifications



| Single Output | | | | | | | |
|------------------|---------------------|----------------------|--|-------------------------------|-----------------|------------------------------|---------------------|
| Model | Input Voltage (VDC) | Output Voltage (VDC) | Input Current Full No load typ. (mA) | Output Current max min (mA) | Isolation (VDC) | Maximum capacitive Load (μF) | Efficiency Typ. (%) |
| AM2LS-1205SJZ | 12 (10.8-13.2) | 5 | 196 / 8 | 400 / 40 | 1500 | 2400 | 83 |
| AM2LS-1212SJZ | 12 (10.8-13.2) | 12 | 196 / 8 | 167 / 17 | 1500 | 560 | 84 |
| AM2LS-1215SJZ | 12 (10.8-13.2) | 15 | 196 / 8 | 133 / 13 | 1500 | 560 | 84 |
| AM2LS-1224SJZ | 12 (10.8-13.2) | 24 | 196 / 8 | 83 / 8 | 1500 | 220 | 85 |
| AM2LS-2405SJZ | 24 (21.6-26.4) | 5 | 98 / 8 | 400 / 40 | 1500 | 2400 | 83 |
| AM2LS-2412SJZ | 24 (21.6-26.4) | 12 | 98 / 8 | 167 / 17 | 1500 | 560 | 84 |
| AM2LS-2415SJZ | 24 (21.6-26.4) | 15 | 98 / 8 | 133 / 13 | 1500 | 560 | 84 |
| AM2LS-2424SJZ | 24 (21.6-26.4) | 24 | 98 / 8 | 83 / 8 | 1500 | 220 | 85 |
| AM2LS-1205SH30JZ | 12 (10.8-13.2) | 5 | 196 / 8 | 400 / 40 | 3000 | 2400 | 83 |
| AM2LS-1212SH30JZ | 12 (10.8-13.2) | 12 | 196 / 8 | 167 / 17 | 3000 | 560 | 84 |
| AM2LS-1215SH30JZ | 12 (10.8-13.2) | 15 | 196 / 8 | 133 / 13 | 3000 | 560 | 84 |
| AM2LS-1224SH30JZ | 12 (10.8-13.2) | 24 | 196 / 8 | 83 / 8 | 3000 | 220 | 85 |
| AM2LS-2405SH30JZ | 24 (21.6-26.4) | 5 | 98 / 8 | 400 / 40 | 3000 | 2400 | 83 |
| AM2LS-2412SH30JZ | 24 (21.6-26.4) | 12 | 98 / 8 | 167 / 17 | 3000 | 560 | 84 |
| AM2LS-2415SH30JZ | 24 (21.6-26.4) | 15 | 98 / 8 | 133 / 13 | 3000 | 560 | 84 |
| AM2LS-2424SH30JZ | 24 (21.6-26.4) | 24 | 98 / 8 | 83 / 8 | 3000 | 220 | 85 |

Note: Use suffix "TR" for tape & reel packing (ex. AM2LS-1205SJZTR).

Input Specification

| Parameters | Conditions | Typical | Maximum | Units |
|--------------------------------|----------------------------|---------|---------|-------|
| Filter | Capacitor | | | |
| Absolute maximum rating | Maximum duration 1s, 12Vin | >0.7 | 18 | VDC |
| | Maximum duration 1s, 24Vin | >0.7 | 30 | VDC |
| Input reflected ripple current | | 30 | | mA |

Isolation Specification

| Parameters | Conditions | Typical | Maximum | Units |
|--------------------|--------------------------------------|---------|---------|-------|
| Tested I/O voltage | 60 sec, leakage ≤ 1mA | >1500 | | VDC |
| | 60 sec, leakage ≤ 1mA for H30 models | >3000 | | VDC |
| Resistance | 500VDC | >1000 | | MΩ |
| Capacitance | 100kHz/0.1V | 20 | | pF |

Output Specification

| Parameters | Conditions | Typical | Maximum | Units |
|------------------|------------------------------|---------|---------|-------|
| Voltage accuracy | See output voltage tolerance | | 10 | % |
| Line regulation | Per 1% Vin change | | 1.2 | % |
| Load regulation | 10-100% load, 5Vout | 10 | 15 | % |
| | 10-100% load, 12Vout | 7 | 10 | % |
| | 10-100% load, 15Vout | 6 | 10 | % |
| | 10-100% load, 24Vout | 5 | 10 | % |

| | | | | |
|-------------------------|--|-------|-----|----------|
| Temperature coefficient | | ±0.02 | | %/°C |
| Ripple & Noise* | | 50 | 150 | mV pk-pk |
| Minimum load** | | 10 | | % |

* Ripple and Noise are measured at 20MHz bandwidth. Please refer to the application note for specific details.
** If the required power is less than 1% of the rated converter output, connect a bleeder resistor in parallel with the load to satisfy the minimum load requirement.

| General Specifications | | | | |
|------------------------------|---|---|---------|-------|
| Parameters | Conditions | Typical | Maximum | Units |
| Switching frequency | Full load, nominal input | 260 | | KHz |
| Short circuit protection | Continuous, Auto recovery | | | |
| Operating temperature | With derating at 100°C | -40 to +105 | | °C |
| Storage temperature | | -55 to +125 | | °C |
| Maximum Case temperature | | 130 | | °C |
| Reflow soldering temperature | Maximum duration 60s when over 217°C | | 245 | °C |
| Soldering method | IPC/JEDEC J-STD-020D.1. | | | |
| Cooling | Free air convection | | | |
| Humidity | Non-condensing | >5 | 95 | % RH |
| Moisture sensitivity level | Level 1 | | | |
| Case material | Black plastic (flammability to UL 94V-0) | | | |
| Weight | | 1.4 | | g |
| Dimensions (L x W x H) | | 0.52 x 0.45 x 0.28 inches (13.20 x 11.40 x 7.25 mm) | | |
| MTBF | 3 500 000 hrs (MIL-HDBK -217F, t=+25°C) / Full Load | | | |

NOTE: All specifications in this datasheet are measured at an ambient temperature of 25°C, humidity<75%, nominal input voltage and at rated output load unless otherwise specified.

| Safety Specifications | | |
|-----------------------|---------------------------------------|---|
| Parameters | | |
| Standards | Information technology Equipment | Design to meet EN62368 |
| | EMC - Conducted and radiated emission | CISPR32 / EN55032, class B with the recommended EMI circuit |
| | Electrostatic Discharge Immunity | IEC 61000-4-2 Air ±8KV, Contact ±6KV, Criteria B |

Derating

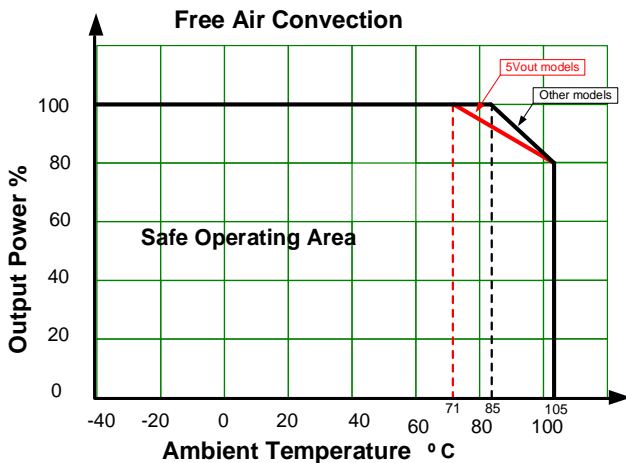

Output voltage tolerance



Tolerance Envelope Graph

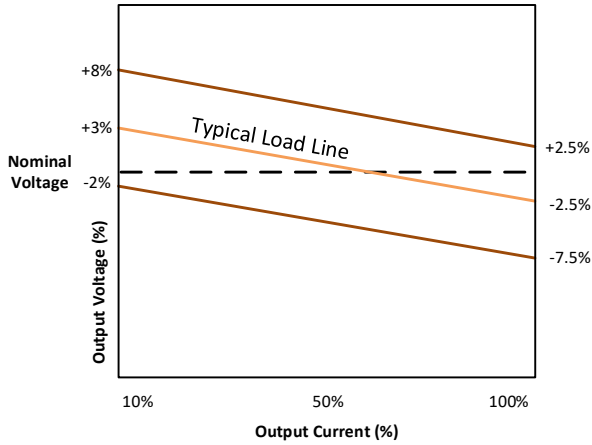

Typical application circuit

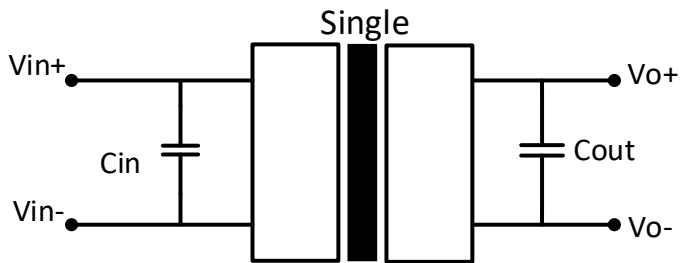

| Vin | Cin | Single output models | |
|-----|-----------|----------------------|------------|
| | | Vout | Cout |
| 12 | 2.2μF/25V | 5V | 10μF/16V |
| 24 | 1μF/50V | 12V | 2.2μF/25V |
| - | - | 15V | 1μF/25V |
| - | - | 24V | 0.47μF/50V |

EMI Recommended circuit

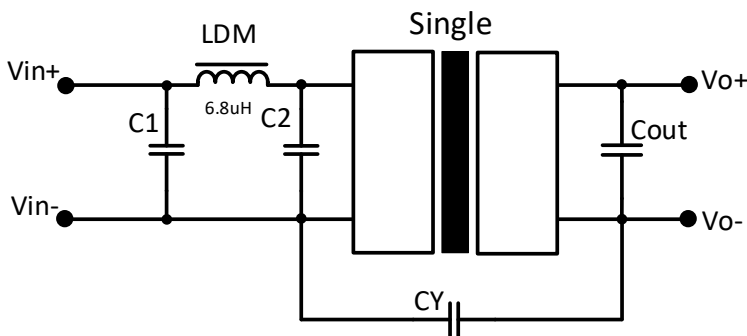

| Vin | C1/C2 | CY |
|---------|-----------|-------------|
| 12V/24V | 4.7μF/50V | 270pF/3kVdc |

Dimensions

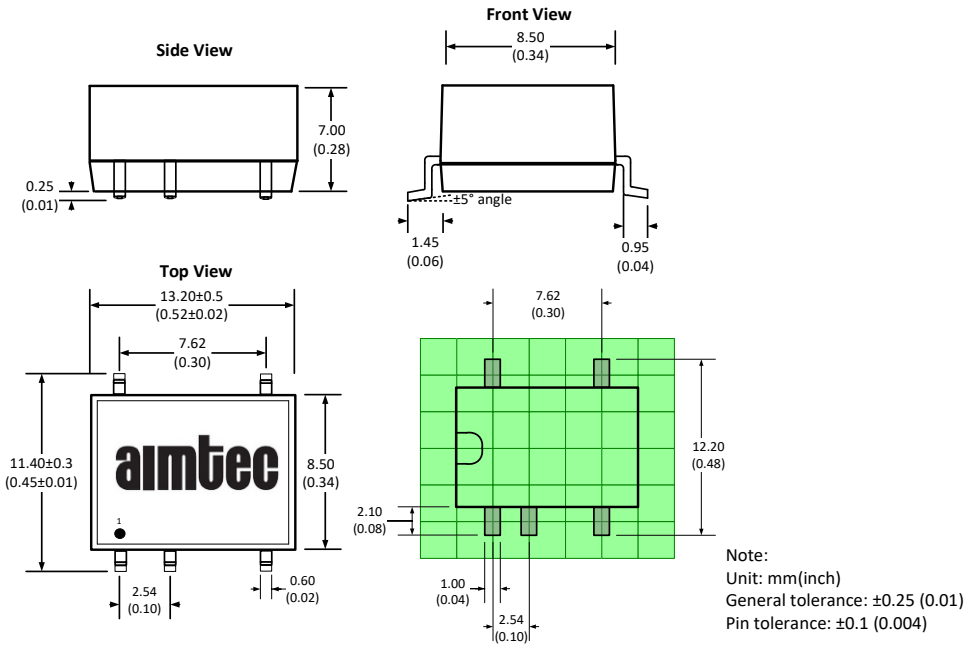

| Pin Out Specifications | |
|------------------------|-----------|
| Pin | Single |
| 1 | -V Input |
| 2 | +V Input |
| 3 | - |
| 4 | -V Output |
| 5 | +V Output |
| 6 | - |
| 7 | - |
| 8 | NC |

Packing Information

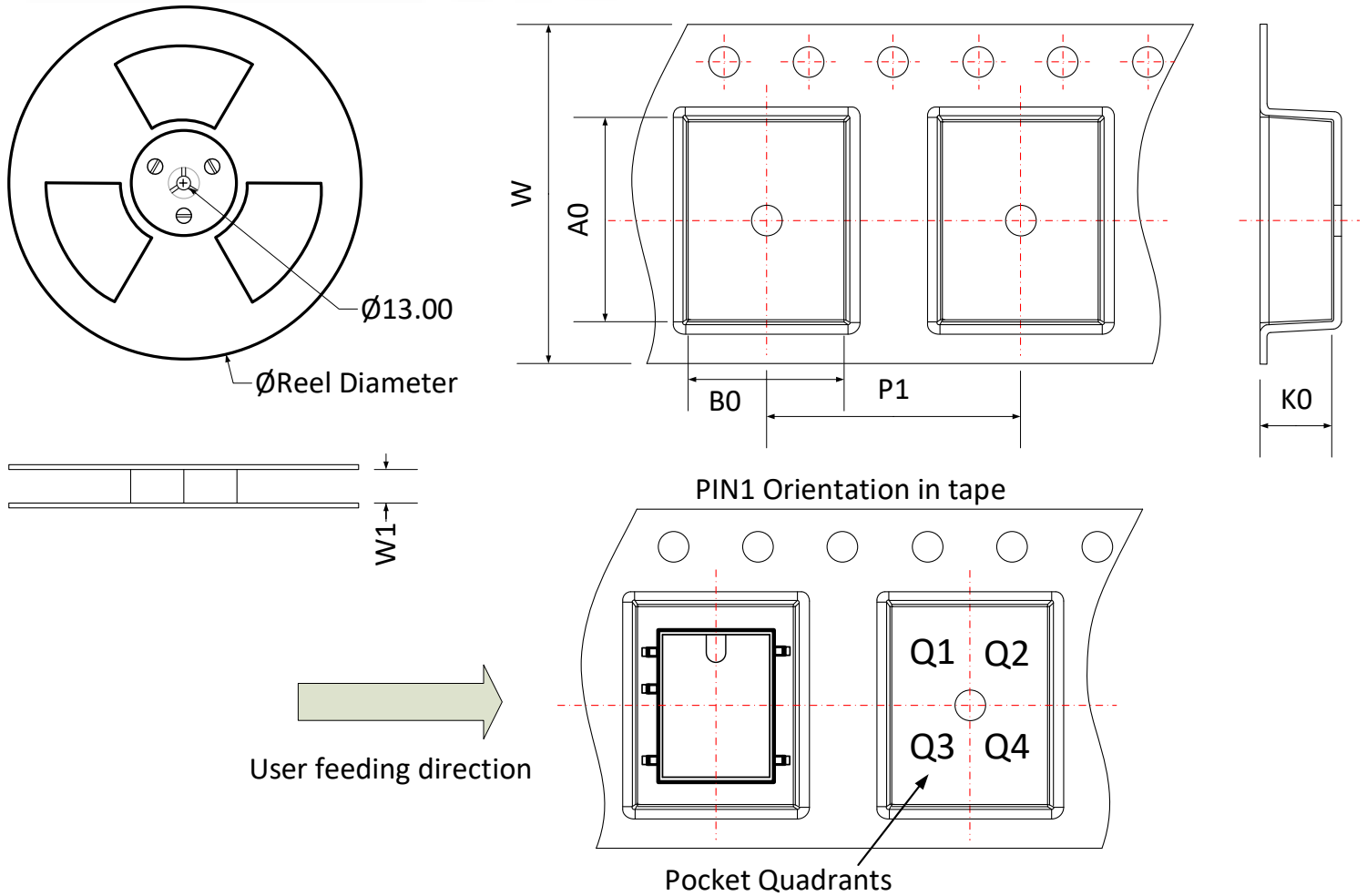

| Device | Package Type | Pin | MPQ | Reel Diameter (mm) | Reel Width W1 (mm) | A0 | B0 | K0 | P1 | W | P1 Quadrant |
|----------|--------------|-----|-----|--------------------|--------------------|------|------|-----|------|------|-------------|
| AM2LS-JZ | SMD | 5 | 500 | 330.0 | 24.5 | 13.4 | 11.7 | 7.5 | 16.0 | 24.0 | Q1 |

NOTE: 1. Datasheets are updated as needed and as such, specifications are subject to change without notice. Once printed or downloaded, datasheets are no longer controlled by Aimtec; refer to www.aimtec.com for the most current product specifications. **2.** Product labels shown, including safety agency certifications on labels, may vary based on the date manufactured. **3.** Mechanical drawings and specifications are for reference only. **4.** All specifications are measured at an ambient temperature of 25°C, humidity<75%, nominal input voltage and at rated output load unless otherwise specified. **5.** Aimtec may not have conducted destructive testing or chemical analysis on all internal components and chemicals at the time of publishing this document. CAS numbers and other limited information are considered proprietary and may not be available for release. **6.** This product is not designed for use in critical life support systems, equipment used in hazardous environments, nuclear control systems or other such applications which necessitate specific safety and regulatory standards other the ones listed in this datasheet. **7.** Warranty is in accordance with Aimtec's standard Terms of Sale available at www.aimtec.com.

X-ON Electronics

Largest Supplier of Electrical and Electronic Components

Click to view similar products for [Isolated DC/DC Converters](#) category:

Click to view products by [Aimtec](#) manufacturer:

Other Similar products are found below :

[ESM6D044440C05AAQ](#) [FMD15.24G](#) [PSL486-7LR](#) [Q48T30020-NBB0](#) [18362](#) [JAHW100Y1](#) [SPB05C-12](#) [SQ24S15033-PS0S](#) [19-130041](#)
[CE-1003](#) [GQ2541-7R](#) [RDS180245](#) [MAU228](#) [J80-0041NL](#) [DFC15U48D15](#) [XGS-0512](#) [XGS-1205](#) [XGS-1212](#) [XGS-2412](#) [XGS-2415](#) [XKS-](#)
[1215](#) [06322](#) [NCT1000N040R050B](#) [SPB05B-15](#) [SPB05C-15](#) [L-DA20](#) [DCG40-5G](#) [QME48T40033-PGB0](#) [XKS-2415](#) [XKS-2412](#) [XKS-1212](#)
[XKS-1205](#) [XKS-0515](#) [XKS-0505](#) [XGS-2405](#) [XGS-1215](#) [XGS-0515](#) [73-551-5038I](#) [AK1601-9RT](#) [VI-N61-CM](#) [VI-R5022-EXWW](#) [PSC128-](#)
[7iR](#) [RPS8-350ATX-XE](#) [DAS1004812](#) [PQA30-D24-S24-DH](#) [VI-M5F-CQ](#) [VI-LN2-EW](#) [VI-PJW01-CZY](#) [CK2540-9ERT](#) [AK-1615-7R](#)