

Click to
ORDER
samples

AM40CW-NZ



The AM40CW-NZ is a 40W DC/DC converter that offers a regulated output which contributes to a more stable and reliable output performance. It features a wide 4:1 input voltage range of 9-75VDC, which will benefit your new system design.

This series offers great operating temperatures, from -40°C to 105°C. Furthermore, an isolation of 1500VDC, a high MTBF of 1,000,000h, continuous output short circuit protection (OSCP), over-current protection (OCP), over-voltage protection (OVP), over-temperature protection (OTP) and under voltage protection (UVP) come standard with the series.

The AM40CW-NZ is suitable for grid power, instrumentation, industrial controls, communication, and civil applications.

Features



- Operating Temp: -40 °C to +105 °C
- Isolation voltage: 1500VDC
- High efficiency: Up to 91.5% typ.
- Regulated single output
- Output short circuit, over-current, over-voltage, over-temperature, input under voltage protection
- Standard 1 x1 package

Summary

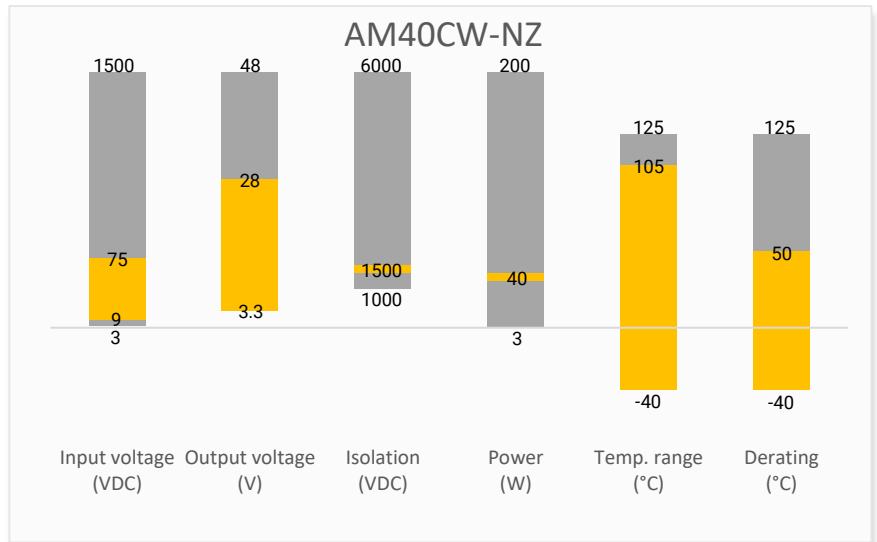

Training

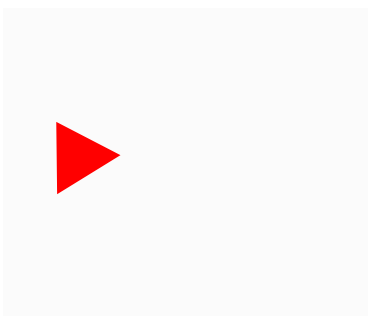

Product Training Video
(click to open)

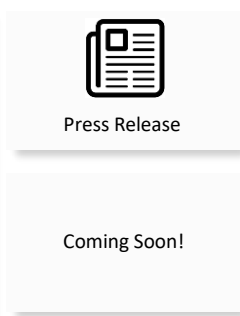

Application Notes

Applications



Power Grid



Industrial



Telecom



Instrumentation

Models & Specifications

Single Output							
Model	Input Voltage (VDC)	Output Voltage (VDC)	Nominal Vin Input Current Max (mA)		Output Current Max (A)	Maximum Capacitive Load (μ F)	Efficiency Full Load Typ (%)
			No Load	Full Load			
AM40CW-2403SNZ	24 (9-36)	3.3	12	1580	10	7200	89.5
AM40CW-2405SNZ	24 (9-36)	5	12	1894	8	7200	90
AM40CW-2412SNZ	24 (9-36)	12	12	1894	3.33	2000	91
AM40CW-2415SNZ	24 (9-36)	15	12	1894	2.67	1500	91.5
AM40CW-2424SNZ	24 (9-36)	24	12	1894	1.67	1000	90
AM40CW-2428SNZ	24 (9-36)	28	12	1894	1.43	1000	90
AM40CW-4803SNZ	48 (18-75)	3.3	15	790	10	7200	89
AM40CW-4805SNZ	48 (18-75)	5	15	947	8	7200	90
AM40CW-4812SNZ	48 (18-75)	12	15	947	3.33	2000	91
AM40CW-4815SNZ	48 (18-75)	15	15	947	2.67	1500	91

Input Specification				
Parameters	Conditions	Typical	Maximum	Units
Absolute maximum rating	24V input, 1s max.	≥ -0.7	50	VDC
	48V input, 1s max.	≥ -0.7	100	VDC
Start-up voltage	24V input		9	VDC
	48V input		18	VDC
Start-up time	Nominal input	30	100	ms
Input reflected current	Nominal input	100		mA
Input under-voltage protection	24V input	7.5		VDC
	48V input	15		VDC
On/Off control	On		Control pin open or 3.5-12VDC	
	Off		Control pin short to $-V_{in}$ or 0-1.2VDC	
	Idle current	6	12	mA
Input filter	Capacitor filter			

Output Specification				
Parameters	Conditions	Typical	Maximum	Units
Voltage accuracy	5% -100% load	± 1	± 3	%
Line regulation	LL – HL 100% load	± 0.2	± 0.5	%
Load regulation	5% -100% load	± 0.5	± 1	%
Transient Recovery Time	25% load step change	250	500	μ s
Transient Response Deviation	25% load step change	± 5	± 8	%
Ripple & Noise *	5% -100% load, 20MHz bandwidth	100	150	mV pk-pk
Voltage adjustment			± 10	%

* Ripple and Noise are measured at 20MHz bandwidth. Please refer to the application note for specific details.

Isolation Specification				
Parameters	Conditions	Typical	Maximum	Units
Tested isolation voltage	Input / output, 60 sec, ≤ 1mA	≥1500		VDC
Resistance	Input / output, 500VDC	≥1000		MΩ
Capacitance	Input / output, 100KHz / 0.1V, 24V input	10000		pF
	Input / output, 100KHz / 0.1V, 48V input	2200		pF

General Specifications				
Parameters	Conditions	Typical	Maximum	Units
Switching frequency*	PWM mode	400		KHz
Short circuit protection	Continuous, Auto recovery, hiccup			
Over current protection		≥110	200	% of Iout
Over voltage protection		≥110	160	% of Vout
Over temperature protection		125		°C
Operating temperature	With derating	-40 to +105		°C
Storage temperature		-55 to +125		°C
Soldering temperature	1.5mm distance, ≤ 10s		300	°C
Temperature coefficient	100% Load		± 0.03	%/°C
Cooling	Free air convection			
Storage humidity	Non-condensing	≥5	95	% RH
Weight		20		g
Vibration test	10-150Hz, 5G, 0.75mm, along all axis			
Dimensions (L x W x H)	1.00x 1.00 x 0.46 inches (25.40 x 25.40 x 11.70 mm)			
Case material	Aluminum			
MTBF	≥ 1 000 000 hrs (MIL-HDBK -217F, t=+25°C)			

*Switching frequency reduced when load < 50%.
NOTE: All specifications in this datasheet are measured at an ambient temperature of 25°C, humidity<75%, nominal input voltage and at rated output load unless otherwise specified.

Safety Specifications		
Parameters		
Agency approvals	EN/BS EN 62368-1	
Standards	EMI - Conducted and radiated emission	CISPR32/EN55032 Class B with the recommended EMC circuit
	Electrostatic Discharge Immunity	IEC/EN 61000-4-2, Contact ±6KV, Criteria B
	RF, Electromagnetic Field Immunity	IEC/EN 61000-4-3, 10V/m, Criteria A
	Electrical Fast Transient/Burst Immunity	IEC/EN 61000-4-4, ±2KV, Criteria A with the recommended EMC circuit part A
	Surge Immunity	IEC/EN 61000-4-5, L-L ±2KV, Criteria A with the recommended EMC circuit part A
	RF, Conducted Disturbance Immunity	IEC/EN 61000-4-6, 3 Vr.m.s, Criteria A

Derating



For AM40CW-2403SNZ model

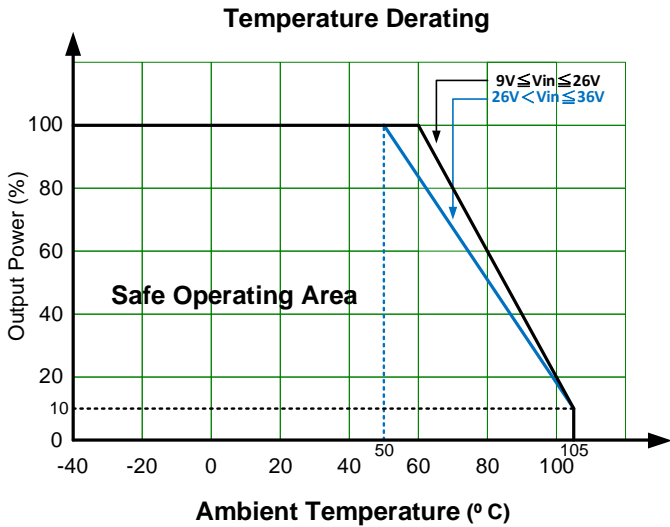

For AM40CW-2405SNZ model

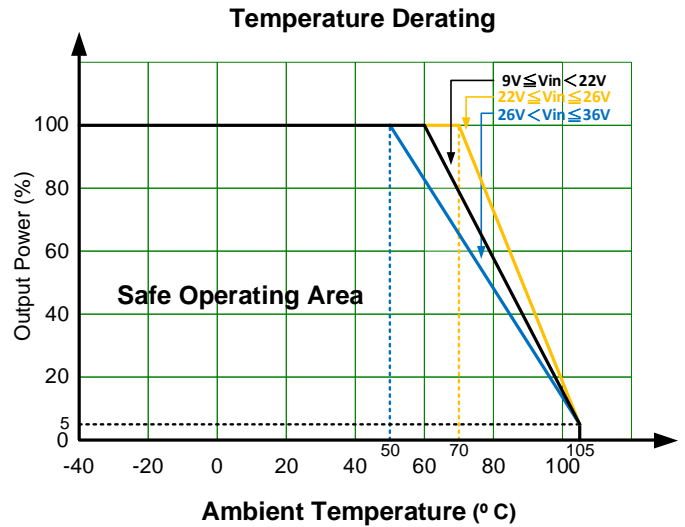

For AM40CW-2412SNZ /
AM40CW-2415SNZ models

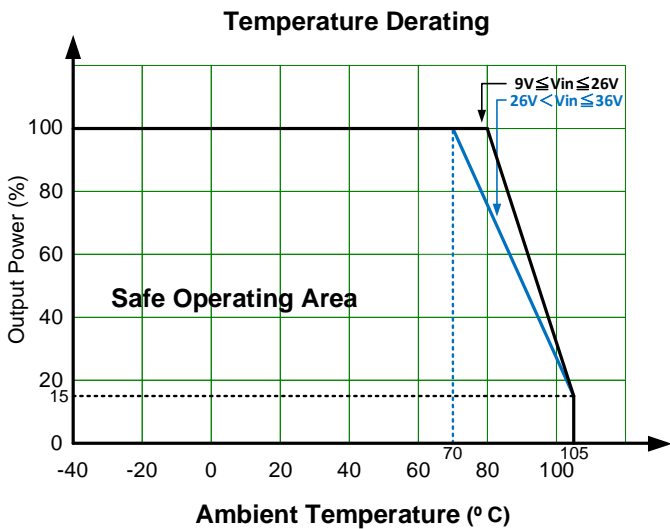

For AM40CW-2424SNZ /
AM40CW-2428SNZ models

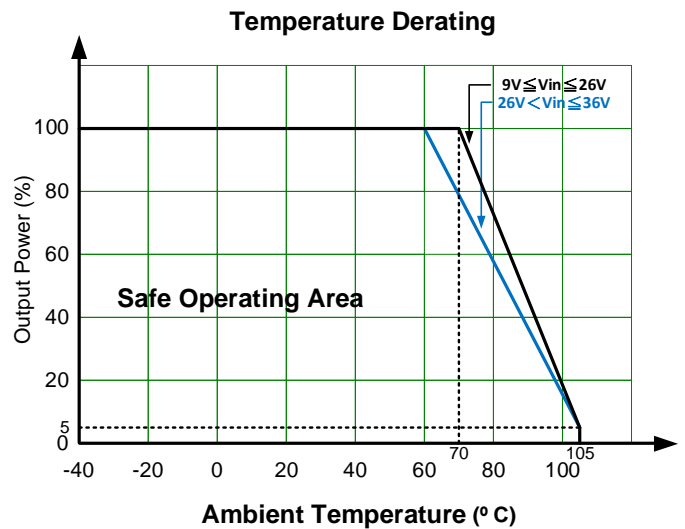

For AM40CW-4803SNZ model

For AM40CW-4805SNZ model

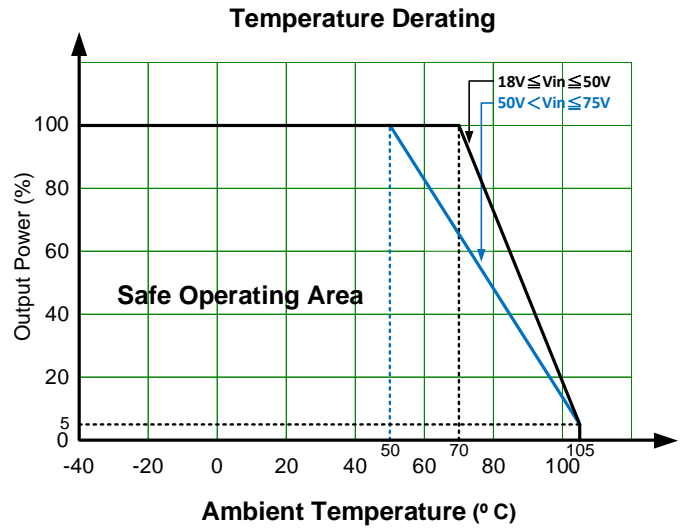
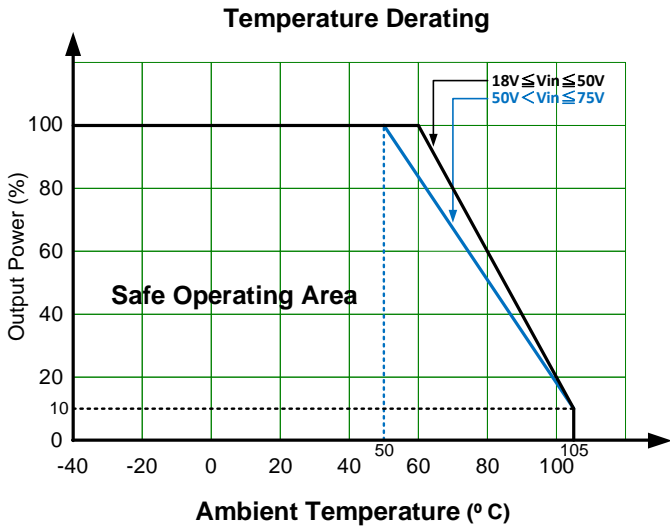

For AM40CW-4812SNZ / AM40CW-4815SNZ models

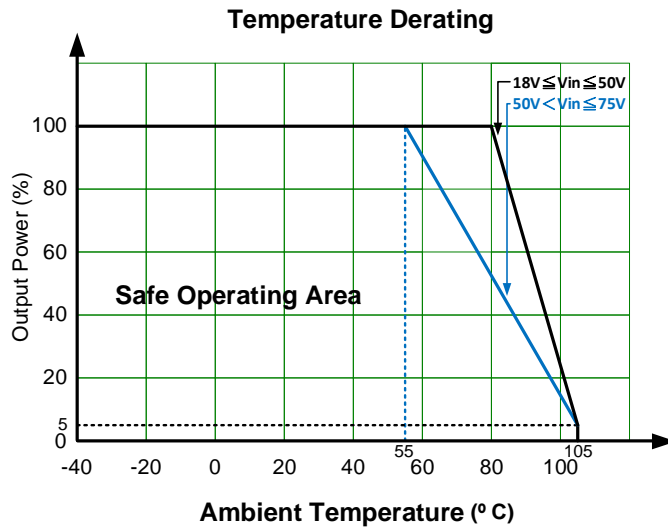

For 24Vin models

Free Air Convection at 25°C

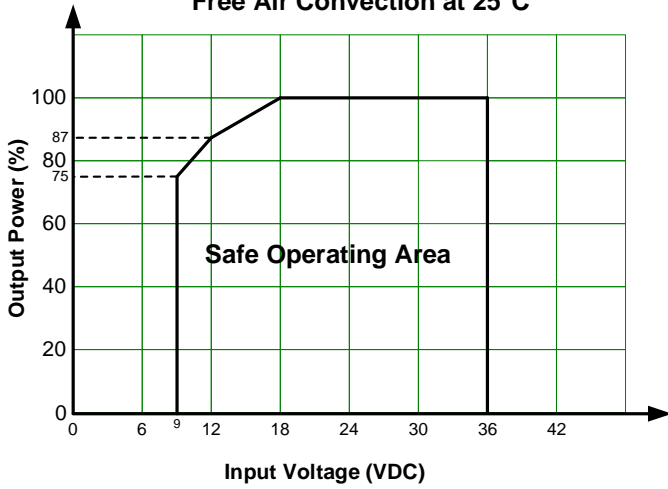

For 48Vin models

Free Air Convection at 25°C

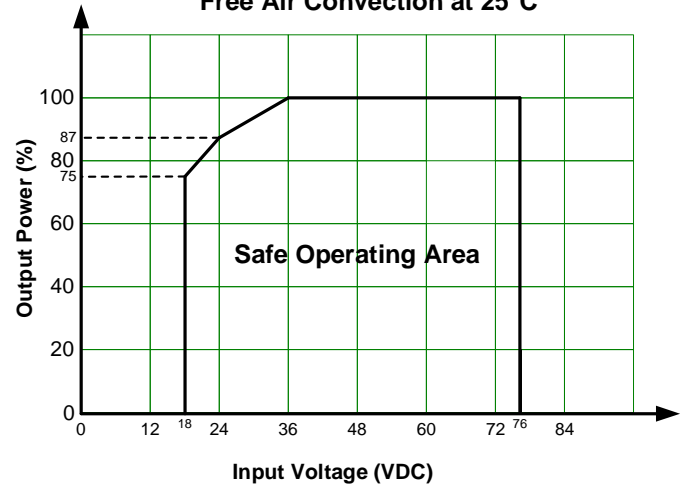

Typical application circuit

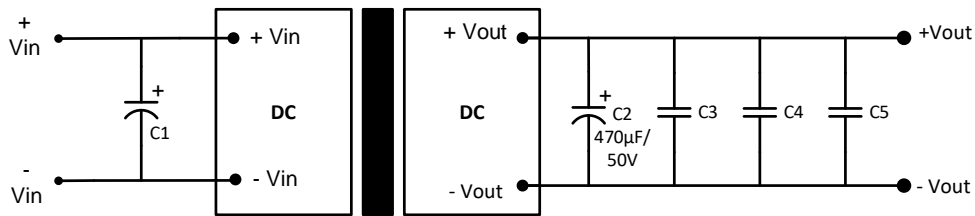

Vin	Vout	C1	C3	C4	C5
24V	3.3V / 5V	100µF/50V	22µF/16V	1µF/16V	10µF/16V
24V	12V / 15V	100µF/50V	22µF/25V	1µF/25V	10µF/25V
24V	24V / 48V	100µF/50V	22µF/50V	1µF/50V	10µF/50V
48V	3.3V / 5V	100µF/100V	22µF/16V	1µF/16V	10µF/16V
48V	12V / 15V	100µF/100V	22µF/25V	1µF/25V	10µF/25V

Recommended EMC circuit

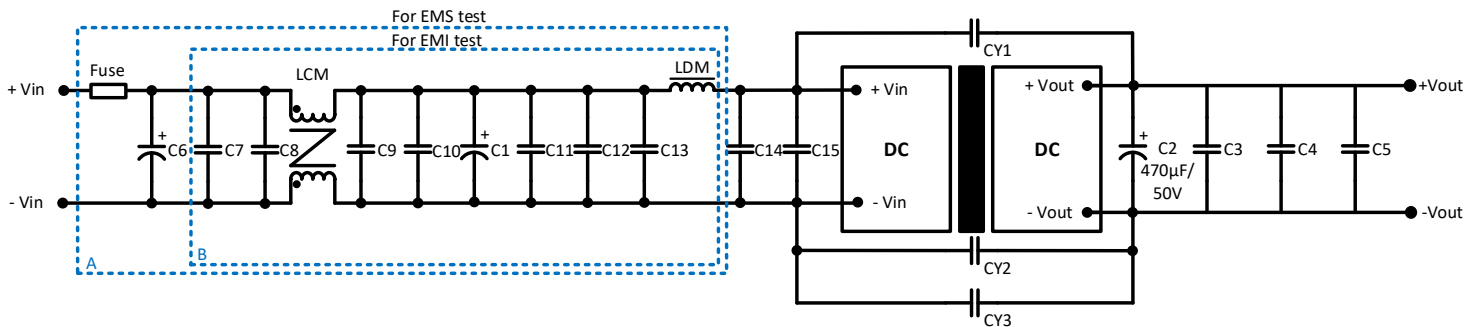

Notes: Part A for EMS filtering and Part B is used for EMI filtering.

The Part B of the circuit can be simplified, and Class A can be satisfied by removing the LCM.

	24V input	48V input
C1	220μF/50V	100μF/100V
C2 / C3 / C4	Refer to the application circuit	Refer to the application circuit
C5	--	Refer to the application circuit
C6	1000μF/50V	680μF/100V
C7 / C8 / C9 C10 / C11 / C12 / C13	4.7μF/50V	4.7μF/100V
C14 / C15	--	4.7μF/100V
CY1 / CY3	--	2200pF/3KV
CY2	Y2/222K/250VAC	2200pF/3KV
LCM	350μH	10mH
LDM	2.2μH	6.8μH

Dimension

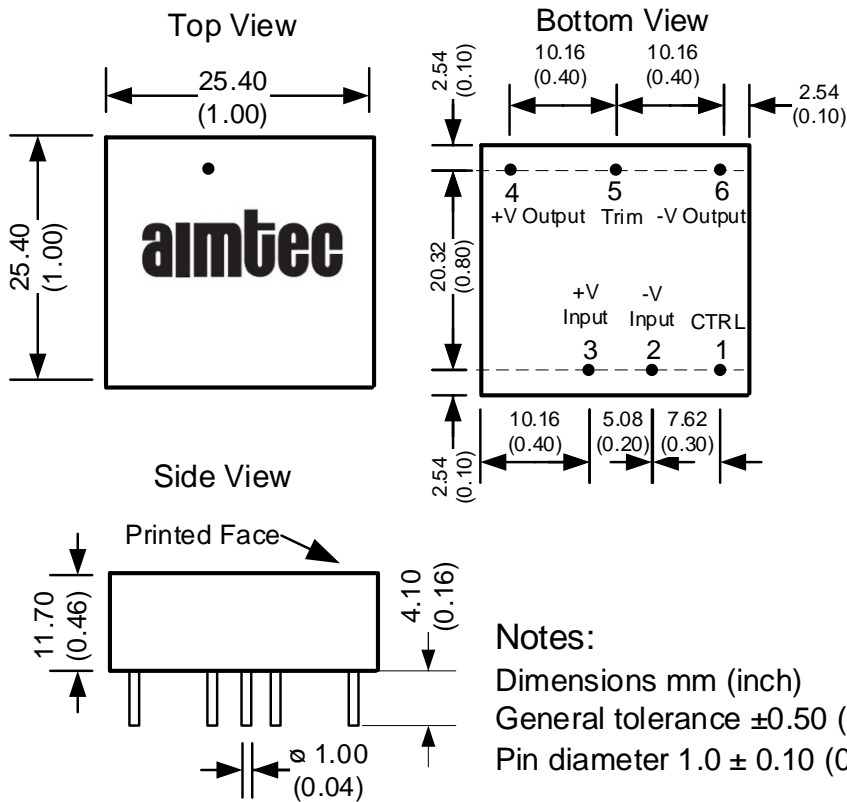

Pin Out Specifications	
Pin	Single
1	On/off control
2	-Vin
3	+Vin
4	+Vout
5	Trim
6	-Vout

Trimming



Output voltage can be externally trimmed by utilizing the methods as shown below

Fixed Resistor

Variable Potentiometer

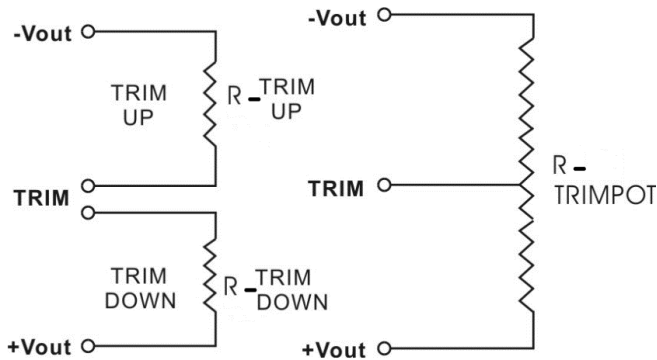

Leave open if not used.

For 3.3V output models

Trim down %	1	2	3	4	5	6	7	8	9	10
Vout (VDC)	3.267	3.234	3.201	3.168	3.135	3.102	3.069	3.036	3.003	2.970
Rt down (KΩ)	107.720	75.384	57.028	45.198	36.938	30.845	26.164	22.456	19.446	16.954
Trim up %	1	2	3	4	5	6	7	8	9	10
Vout (VDC)	3.355	3.366	3.399	3.432	3.465	3.498	3.531	3.564	3.597	3.630
Rt up (KΩ)	4495.982	484.505	128.456	72.366	49.525	37.128	29.344	24.003	20.111	17.148

For 5V output models

Trim down %	1	2	3	4	5	6	7	8	9	10
Vout (VDC)	4.950	4.900	4.850	4.800	4.750	4.700	4.650	4.600	4.550	4.500
Rt down (KΩ)	135.030	63.280	39.363	27.405	20.230	15.447	12.030	9.467	7.474	5.880
Trim up %	1	2	3	4	5	6	7	8	9	10
Vout (VDC)	5.050	5.100	5.150	5.200	5.250	5.300	5.350	5.400	5.450	5.500
Rt up (KΩ)	137.900	66.150	42.233	30.275	23.100	18.317	14.900	12.338	10.344	8.750

For 12V output models

Trim down %	1	2	3	4	5	6	7	8	9	10
Vout (VDC)	11.880	11.760	11.640	11.520	11.400	11.280	11.160	11.040	10.920	10.800
Rt down (KΩ)	813.735	399.920	259.338	188.540	145.897	117.401	97.012	81.703	69.784	60.242
Trim up %	1	2	3	4	5	6	7	8	9	10
Vout (VDC)	12.120	12.240	12.360	12.480	12.600	12.720	12.840	12.960	13.080	13.200
Rt up (KΩ)	219.089	100.320	61.504	42.238	30.724	23.066	17.605	13.515	10.336	7.795

For 15V output models

Trim down %	1	2	3	4	5	6	7	8	9	10
Vout (VDC)	14.850	14.700	14.550	14.400	14.250	14.100	13.950	13.800	13.650	13.500
Rt down (KΩ)	1166.483	568.567	369.261	269.608	209.817	169.956	141.483	120.129	103.520	90.233
Trim up %	1	2	3	4	5	6	7	8	9	10
Vout (VDC)	15.150	15.300	15.450	15.600	15.750	15.900	16.050	16.200	16.350	16.500
Rt up (KΩ)	224.167	104.583	64.722	44.792	32.833	24.861	19.167	14.896	11.574	8.917

For 24V output models

Trim down %	1	2	3	4	5	6	7	8	9	10
Vout (VDC)	23.760	23.520	23.280	23.040	22.800	22.560	22.320	22.080	21.840	21.600
Rt down (KΩ)	1645.641	917.947	628.702	473.386	376.466	310.220	262.075	225.505	196.782	173.627
Trim up %	1	2	3	4	5	6	7	8	9	10
Vout (VDC)	24.240	24.480	24.720	24.960	25.200	25.440	25.680	25.920	26.160	26.400
Rt up (KΩ)	361.706	136.129	78.855	52.703	37.726	28.021	21.222	16.194	12.324	9.253

For 28V output models

Trim down %	1	2	3	4	5	6	7	8	9	10
Vout (VDC)	27.720	27.440	27.160	26.880	26.600	26.320	26.040	25.760	25.480	25.200
Rt down (KΩ)	1844.035	1063.692	739.278	561.554	449.374	372.124	315.688	272.651	238.749	211.353
Trim up %	1	2	3	4	5	6	7	8	9	10
Vout (VDC)	28.280	28.560	28.840	29.120	29.400	29.680	29.960	30.240	30.520	30.800
Rt up (KΩ)	437.770	149.122	84.501	56.012	39.973	29.685	22.526	17.257	13.216	10.019

NOTE: **1.** Datasheets are updated as needed and as such, specifications are subject to change without notice. Once printed or downloaded, datasheets are no longer controlled by Aimtec; refer to www.aimtec.com for the most current product specifications. **2.** Product labels shown, including safety agency certifications on labels, may vary based on the date manufactured. **3.** Mechanical drawings and specifications are for reference only. **4.** All specifications are measured at an ambient temperature of 25°C, humidity<75%, nominal input voltage and at rated output load unless otherwise specified. **5.** Aimtec may not have conducted destructive testing or chemical analysis on all internal components and chemicals at the time of publishing this document. CAS numbers and other limited information are considered proprietary and may not be available for release. **6.** This product is not designed for use in critical life support systems, equipment used in hazardous environments, nuclear control systems or other such applications which necessitate specific safety and regulatory standards other the ones listed in this datasheet. **7.** Warranty is in accordance with Aimtec's standard Terms of Sale available at www.aimtec.com.

X-ON Electronics

Largest Supplier of Electrical and Electronic Components

Click to view similar products for [Isolated DC/DC Converters](#) category:

Click to view products by [Aimtec](#) manufacturer:

Other Similar products are found below :

[PSL486-7LR](#) [Q48T30020-NBB0](#) [JAHW100Y1](#) [SPB05C-12](#) [SQ24S15033-PS0S](#) [CE-1003](#) [CE-1004](#) [MAU228](#) [J80-0041NL](#) [DFC15U48D15](#)
[XGS-1205](#) [06322](#) [SPB05B-15](#) [L-DA20](#) [DCG40-5G](#) [XKS-2405](#) [DPA423R](#) [vi-m13-cw-03](#) [VI-L53-CV](#) [24IBX15-50-0ZG](#) [HZZ01204-G](#)
[SPU02L-09](#) [SPU02M-09](#) [SPU02N-09](#) [QUINT4-BUFFER/24DC/40](#) [QUINT4-CAP/24DC/5/4KJ](#) [73-551-5039I](#) [DFC15U48D15G](#) [SEN-6471-](#)
[1EM](#) [AHV2815DF/HBB](#) [MI-LC21-IX](#) [PAH-48/8.5-D48NB1-C](#) [BM3020-7A](#) [QRS2050P025K00](#) [CM2320-9EG](#) [SKMW15F-05](#)
[V300A28H400BF3](#) [TEN 15-1223](#) [TEQ 100-2418WIR](#) [TEQ 160-7218WIR](#) [R05C05TE05S-R](#) [HQA2W085W033V-N07-S](#) [AM1SS-2405SJZ](#)
[AM2DS-1224SJZ](#) [AM2DS-2405DJZ](#) [AM10SBO-4824SNZ-B](#) [AM15E-2405S-NZ](#) [AM2DS-1212SJZ](#) [AM30SBO-4805SNZ-B](#)
[LT8301ES5#WTRPBF](#)