

Click to
ORDER
samples

AM50QB-JZ



¼ brick

The AM50QB-JZ series is a high-performance quarter brick DC/DC converter specifically designed for a variety of railway applications. It features 50W of output power with no requirement for minimum load, a wide input voltage of 43-160VDC, operating temperature up to 105°C and reinforced I/O isolation of 3000VAC.

Additionally, this series features include input under-voltage protection, output over-voltage, short-circuit, over-current and over-temperature protection, remote On/Off control, remote sense compensation and output voltage trim adjustment.

The AM50QB-JZ meets EN50155 railway standards and are widely used in the centralized lighting, air conditioning and related on-board equipment.

Features



- Operating Temp: -40 °C to +100 °C
- Isolation voltage: 3000VAC
- High efficiency: Up to 89% typ.
- Regulated single output
- Output short circuit, over-current, over-voltage, input under-voltage, over temperature protection
- Standard ¼ brick package
- Design to meet EN50155



Summary

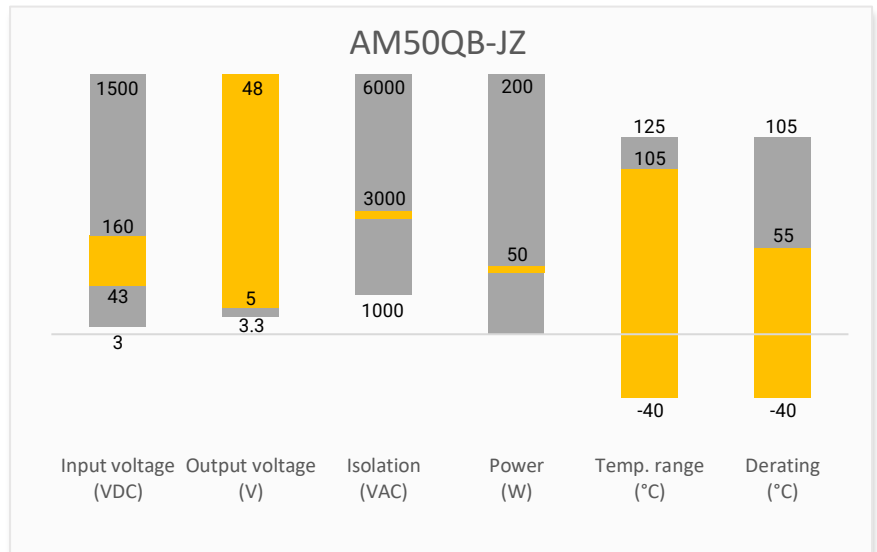

Training



Product Training Video
(click to open)



Press Release

Coming Soon!

Application Notes

Applications



Railway



Industrial

Models & Specifications

Single Output							
Model	Input Voltage (VDC)	Output Voltage (VDC)	Nominal Vin Input Current Max (mA)		Output Current Max (A)	Maximum Capacitive Load (μF)	Efficiency Full Load Typ (%)
			No Load	Full Load			
AM50QB-11003SA30JZ	110 (43-160)	3.3	20	406	11,3	20000	86
AM50QB-11005SA30JZ	110 (43-160)	5	20	535	10	10000	87
AM50QB-11012SA30JZ	110 (43-160)	12	20	529	4,16	3000	88
AM50QB-11015SA30JZ	110 (43-160)	15	20	529	3,33	2350	88
AM50QB-11024SA30JZ	110 (43-160)	24	20	523	2,08	1500	89
AM50QB-11048SA30JZ	110 (43-160)	48	20	535	1,04	240	87

Add suffix "-K" for optional heat sink.

Input Specification				
Parameters	Conditions	Typical	Maximum	Units
Input voltage	Nominal 110V	43 - 160	170	VDC
Absolute maximum rating	1s max.	≥-0.7	180	VDC
Start-up voltage			43	VDC
Shut down voltage		40		VDC
Input reflected current	Nominal 110V	50		mA
On/Off control	On	Control pin open or 3.5-12VDC		
	Off	Control pin short to -Vin or 0-1.2VDC		
Input filter	Idle current	2	10	mA
		Pi filter		

Isolation Specification				
Parameters	Conditions	Typical	Maximum	Units
Tested isolation voltage	Input / output 60 sec, ≤ 5mA	≥3000		VAC
	Input / case 60 sec, ≤ 5mA	≥2100		VAC
	Output / case 60 sec, ≤ 1mA	≥1500		VDC
Resistance	500VDC	≥1000		MΩ
Capacitance	100KHz / 0.1V	2200		pF

Output Specification				
Parameters	Conditions	Typical	Maximum	Units
Voltage accuracy	0% -100% load	±1	±3	%
Line regulation	LL – HL 100% load, 3.3/5V output		±0.5	%
	LL – HL 100% load, others	±0.1	±0.3	%
Load regulation	10% - 100% load, 3.3/5V output	±0.5	±1	%
	10% - 100% load, others	±0.3	±0.5	%
Short circuit protection	Continues, Auto recovery			
Over current protection		140	190	% Io
Over voltage protection	3.3/5V output	≥110	160	% Vo
	others	≥110	140	% Vo
Transient Recovery Time	Nominal input, 25% load step change	200	500	μs

Transient Response Deviation	Nominal input, 25% load step change, 3.3/5V output	±6	±9	%
	Nominal input, 25% load step change, others	±3	±5	%
Ripple & Noise*	20MHz bandwidth, 10% -100% load, 48V output	200	300	mV pk-pk
	20MHz bandwidth, 10% -100% load, others	100	200	mV pk-pk
Trim			±10	%
Sense compensation			5	%

* Tested with the ripple & noise circuit.

General Specifications				
Parameters	Conditions	Typical	Maximum	Units
Switching frequency		170		KHz
Operating temperature	With derating	-40 to +100		°C
Storage temperature		-55 to +125		°C
Over temperature protection	Case temperature	115		°C
Soldering temperature	1.5mm distance, ≤ 10s		300	°C
Temperature coefficient	100% Load		± 0.03	%/°C
Cooling	Free air convection, force air convection			
Humidity	Non-condensing	≥5	95	% RH
Weight	Pin mountable	78		g
	With optional -K heatsink	109		g
Dimensions (L x W x H)	Pin mountable	2.39 x 1.54 x 0.50 inches (60.8 x 39.2 x 12.7 mm)		
	With optional -K heatsink	2.39 x 1.54 x 1.21 inches (60.8 x 39.2 x 27.8 mm)		
Case material	Aluminum case, black plastic bottom (UL94V-0)			
MTBF	≥ 500 000 hrs (MIL-HDBK -217F, t=+25°C)			

NOTE: All specifications in this datasheet are measured at an ambient temperature of 25°C, humidity<75%, nominal input voltage and at rated output load unless otherwise specified.

Environment Approval	
Parameters	Conditions
Cold	EN60068-2-1
Dry heat	EN60068-2-2
Damp heat	EN60068-2-30
Vibration	IEC/EN 61373 Category 1, class B

Safety Specifications		
Parameters		
Standards	Design to meet EN50155	
	EMI - Conducted and radiated emission*	CISPR32/EN55032 Class B with the recommended EMC circuit
		EN50121-3-2 with the recommended EN50155 EMC circuit
		EN55016-2-1 with the recommended EN50155 EMC circuit
	Electrostatic Discharge Immunity	IEC/EN 61000-4-2, Contact ±6KV, Air ±8KV, Criteria A
		EN50121-3-2, Contact ±6KV, Air ±8KV, Criteria A
	RF, Electromagnetic Field Immunity	IEC/EN 61000-4-3, 20V/m, Criteria A
		EN50121-3-2, 20V/m, Criteria A
	Electrical Fast Transient/Burst Immunity	IEC/EN 61000-4-4, ±2KV, Criteria A with the recommended EMC circuit
		EN50121-3-2, ±2KV, Criteria A with the recommended EN50155 EMC circuit
Surge Immunity	IEC/EN 61000-4-5, L-L ±2KV, Criteria A with the recommended EMC circuit	
	EN50121-3-2, L-L ±1KV, Criteria A with the recommended EN50155 EMC circuit	
RF, Conducted Disturbance Immunity	IEC/EN 61000-4-6, 10Vr.m.s, Criteria A	
	EN50121-3-2, 10Vr.m.s, Criteria A	

* CISPR32/EN55032 radiated emission standard does not apply to models with -K heatsink option.

Derating

AM50QB-11003SA30JZ

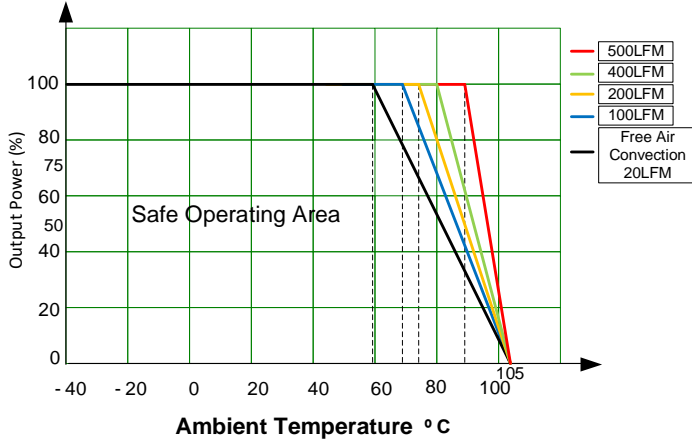

AM50QB-11003SA30JZ-K

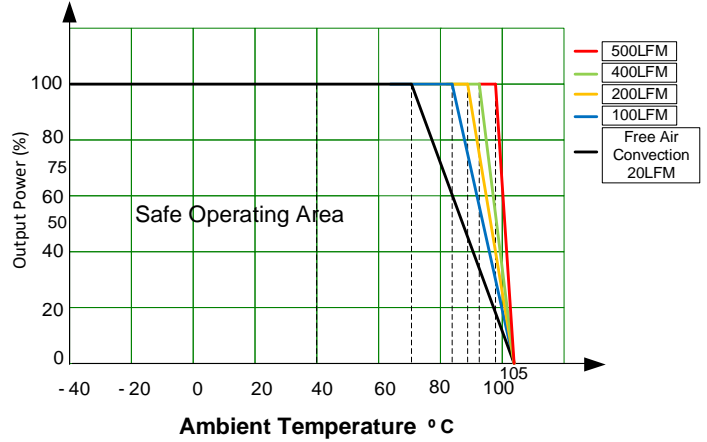

AM50QB-11005SA30JZ

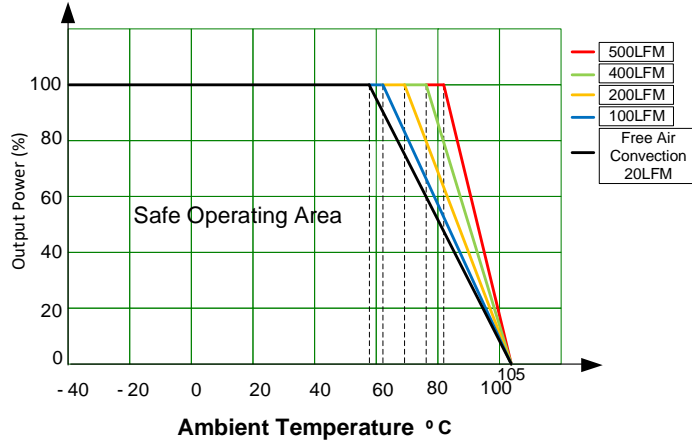

AM50QB-11005SA30JZ-K

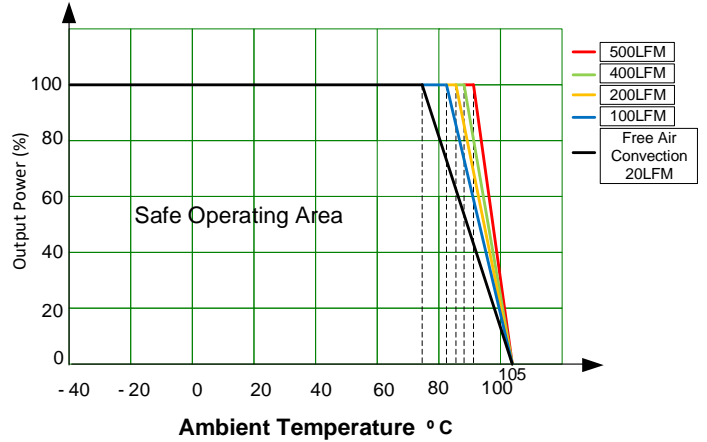

AM50QB-11012SA30JZ

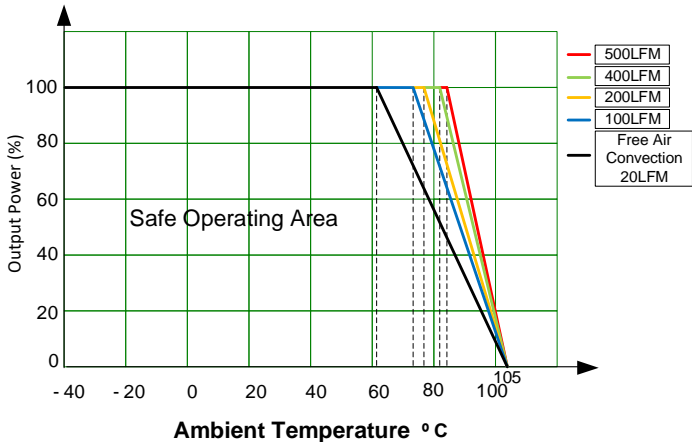

AM50QB-11012SA30JZ-K

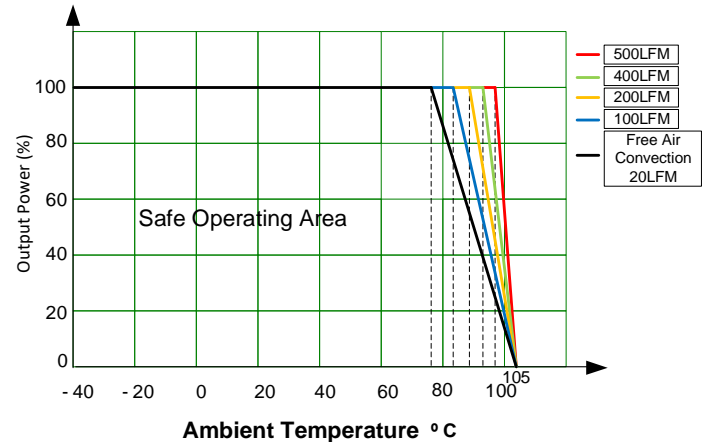

AM50QB-11015SA30JZ

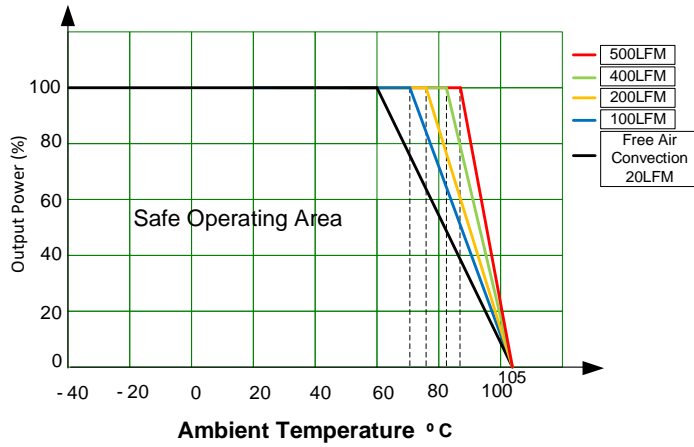

AM50QB-11015SA30JZ-K

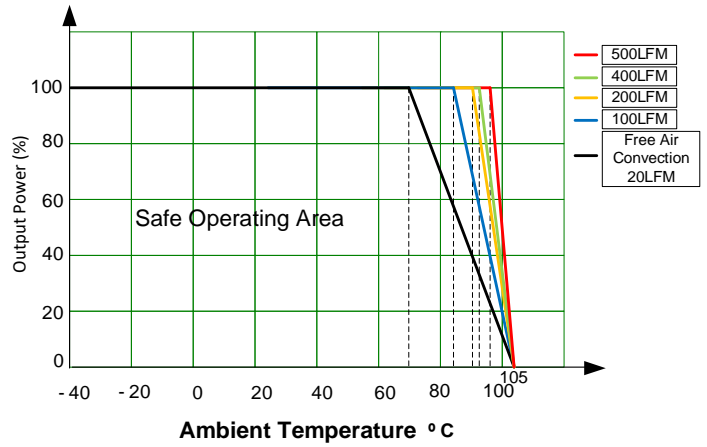

AM50QB-11024SA30JZ

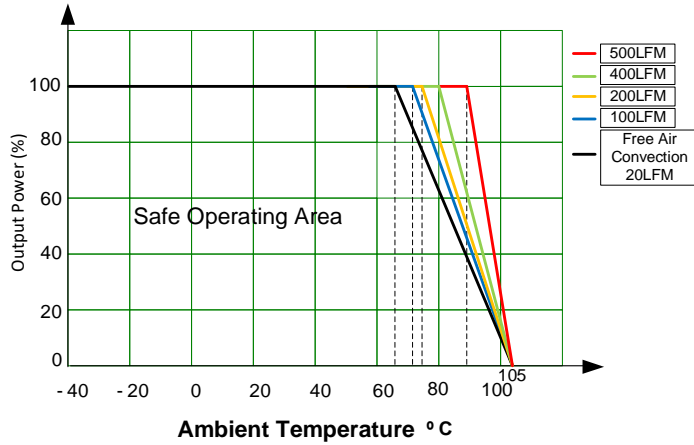

AM50QB-11024SA30JZ-K

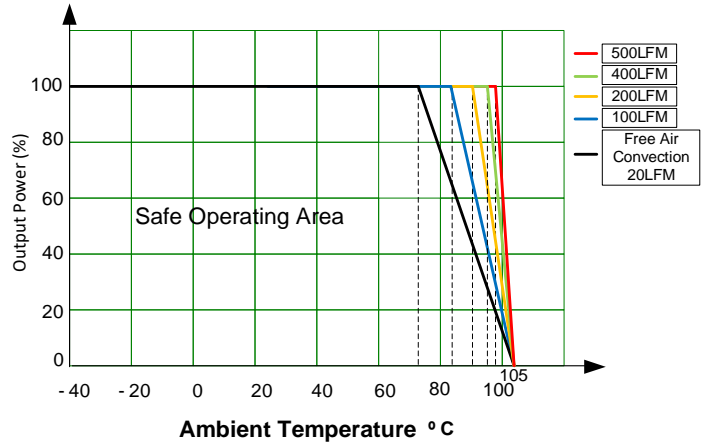

AM50QB-11048SA30JZ

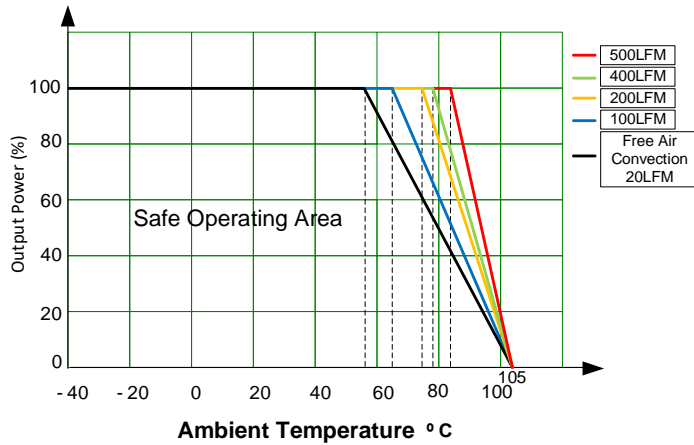

AM50QB-11048SA30JZ-K

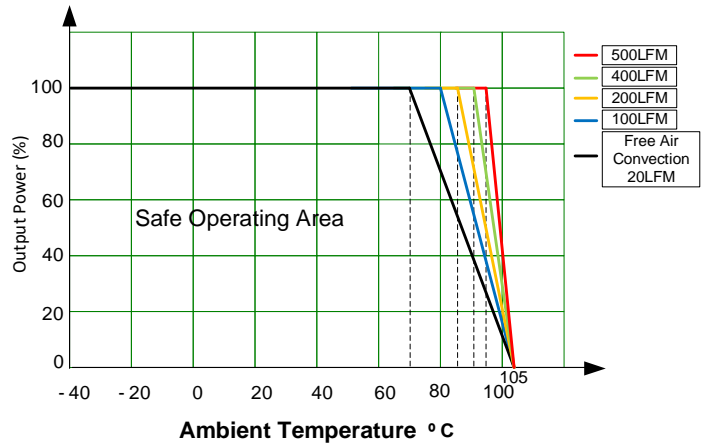

Typical application circuit

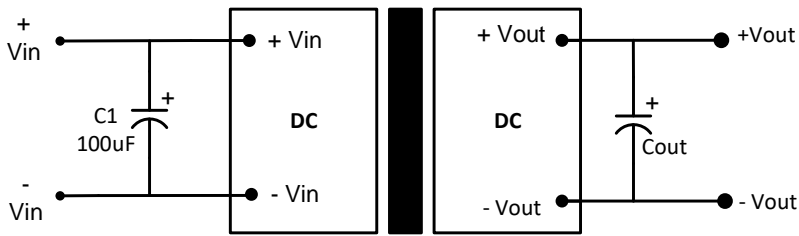

Vout	Cout
3.3	1000μF
5	680μF
12/15/24/48	220μF

- Note:
1. When not using the sense function, connect the +sense to +Vout and -sense to -Vout with the shortest possible traces to avoid interference and minimize the voltage drop.
 2. When using the sense function, connect the sense pins to the load with the shortest possible traces, twisted pair wire or shielded wire and make sure the voltage drop is less than 0.3V.

Ripple & noise circuit

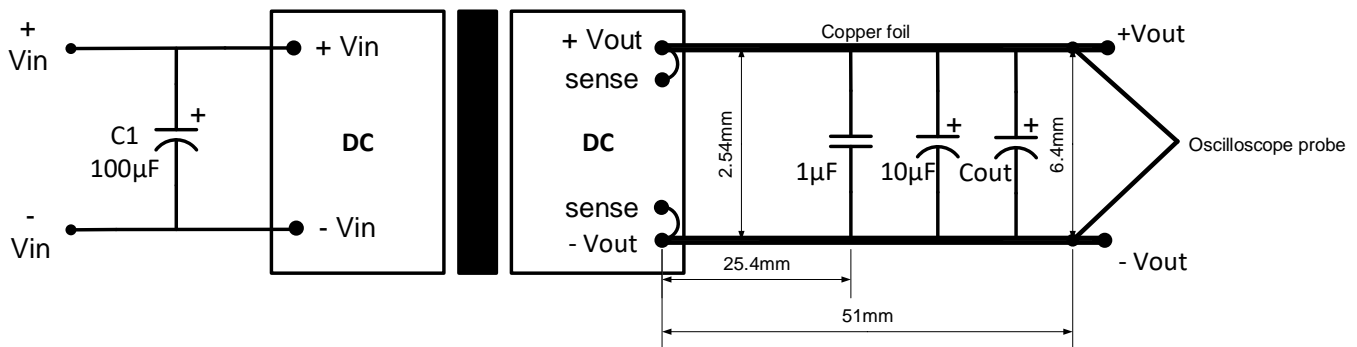

Recommended EMC circuit

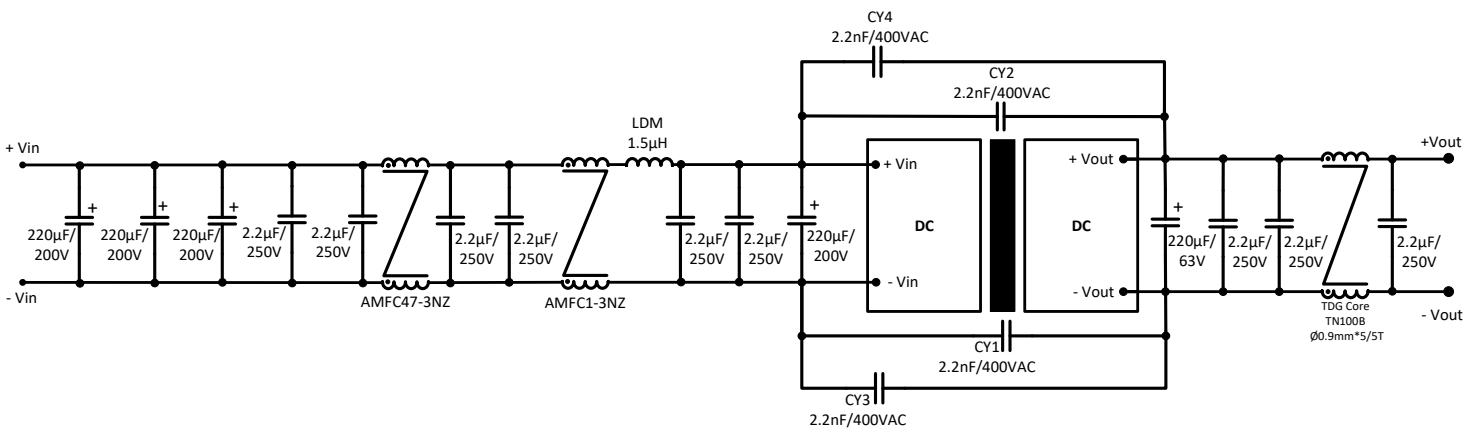

Recommended EN50155 EMC circuit

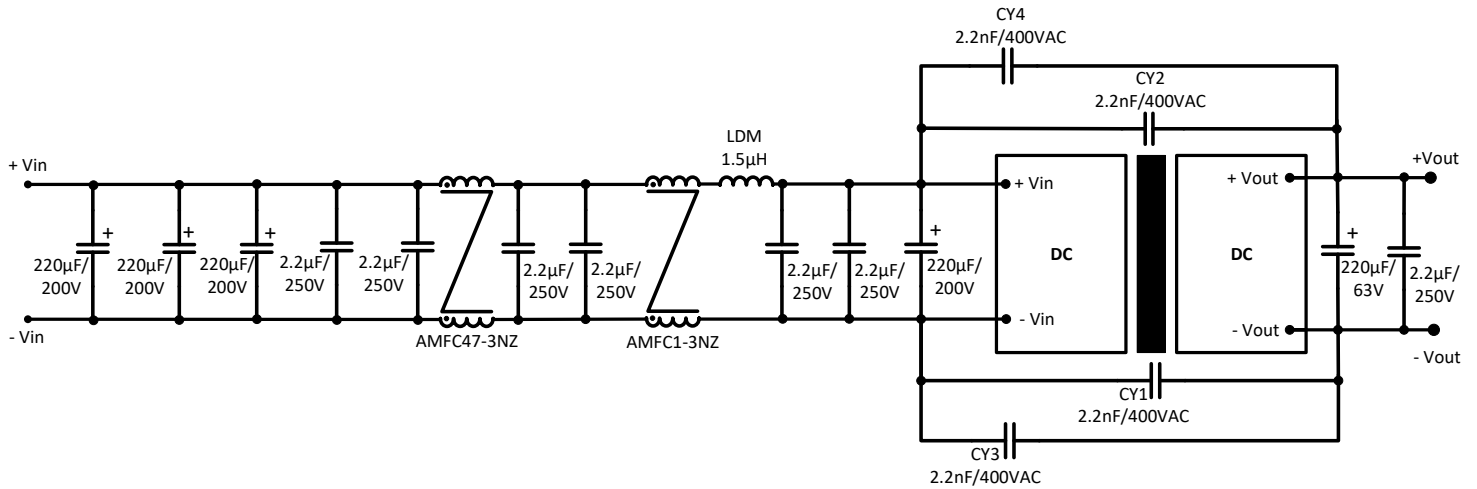

Dimension

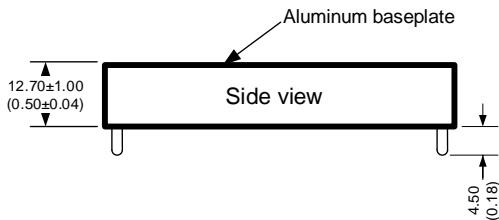
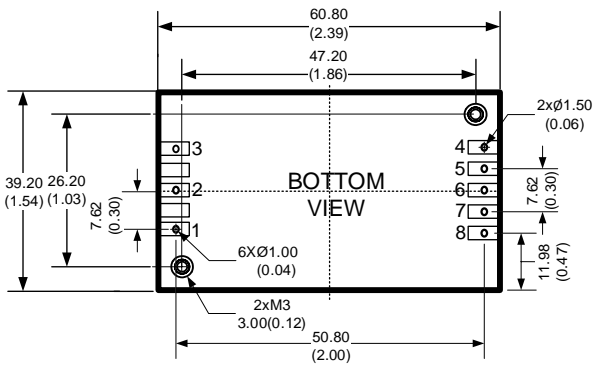

Dimensions: mm (inch)
 General Tolerance: ±0.50 (0.02)
 Pin diameter Tolerance: ±0.10 (0.004)
 Pin 1, 2, 3, 5, 6 & 7 diameter: 1.00 (0.04)
 Pin 4 & 8 diameter: 1.50 (0.06)
 Mounting hole screw torque: max 0.4 N m

Pin Out Specifications

Pin	Single
1	+Vin
2	On/Off Control
3	-Vin
4	-Vout
5	-Sense
6	Trim
7	+Sense
8	+Vout

Dimension for models with -K option

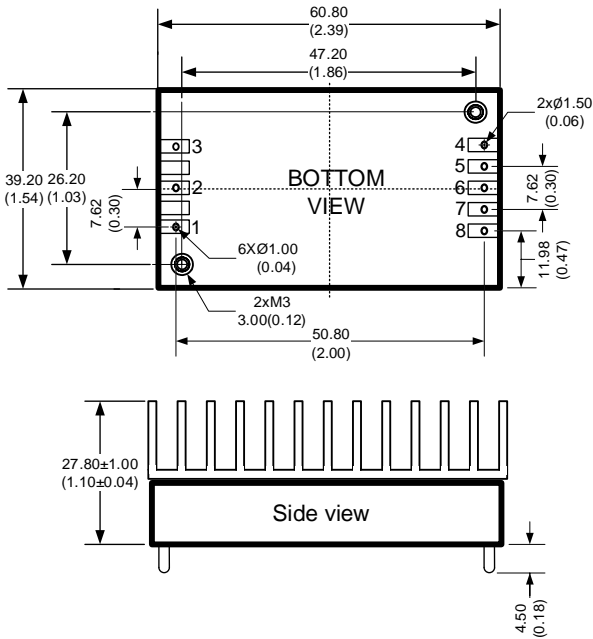

Dimensions: mm (inch)
 General Tolerance: ± 0.50 (0.02)
 Pin diameter Tolerance: ± 0.10 (0.004)
 Pin 1, 2, 3, 5, 6 & 7 diameter: 1.00 (0.04)
 Pin 4 & 8 diameter: 1.50 (0.06)
 Mounting hole screw torque: max 0.4 N m

Trim

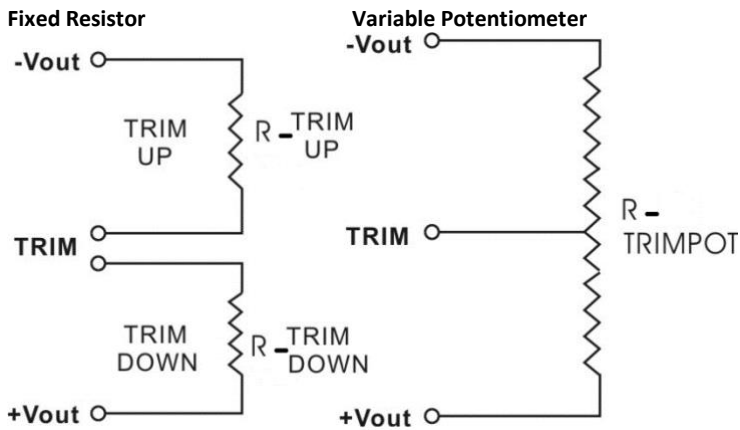

Vout = 3.3V

Trim down %	1	2	3	4	5	6	7	8	9	10
Vout (VDC)	3.267	3.234	3.201	3.168	3.135	3.102	3.069	3.036	3.003	2.97
Rt down (KΩ)	153.979	94.09	65.614	48.971	38.054	30.341	24.603	20.167	16.636	13.757
Trim up %	1	2	3	4	5	6	7	8	9	10
Vout (VDC)	3.333	3.366	3.399	3.432	3.465	3.498	3.531	3.564	3.597	3.63
Rt up (KΩ)	960.922	143.24	73.327	47.287	33.686	25.33	19.674	15.593	12.508	10.095

Vout = 5V

Trim down %	1	2	3	4	5	6	7	8	9	10
Vout (VDC)	4.95	4.9	4.85	4.8	4.75	4.7	4.65	4.6	4.55	4.5
Rt down (KΩ)	343.52	215.672	154.38	118.406	94.748	78.006	65.533	55.882	48.192	41.921
Trim up %	1	2	3	4	5	6	7	8	9	10
Vout (VDC)	5.05	5.1	5.15	5.2	5.25	5.3	5.35	5.4	5.45	5.5
Rt up (KΩ)	1368.623	177.432	90.122	58.103	41.484	31.309	24.439	19.488	15.751	12.83

Vout = 12V

Trim down %	1	2	3	4	5	6	7	8	9	10
Vout (VDC)	11.88	11.76	11.64	11.52	11.4	11.28	11.16	11.04	10.92	10.8
Rt down (KΩ)	500.092	305.452	216.527	165.585	132.573	109.442	92.332	79.164	68.716	60.223
Trim up %	1	2	3	4	5	6	7	8	9	10
Vout (VDC)	12.12	12.24	12.36	12.48	12.6	12.72	12.84	12.96	13.08	13.2
Rt up (KΩ)	710.435	162.92	87.879	58.075	42.077	32.095	25.274	20.317	16.552	13.595

Vout = 15V

Trim down %	1	2	3	4	5	6	7	8	9	10
Vout (VDC)	14.85	14.7	14.55	14.4	14.25	14.1	13.95	13.8	13.65	13.5
Rt down (KΩ)	642.028	402.954	289.279	222.84	179.26	148.474	125.568	107.86	93.761	82.271
Trim up %	1	2	3	4	5	6	7	8	9	10
Vout (VDC)	15.15	15.3	15.45	15.6	15.75	15.9	16.05	16.2	16.35	16.5
Rt up (KΩ)	1275.5	187.455	94.426	59.777	41.679	30.559	23.034	17.602	13.498	10.287

Vout = 24V

Trim down %	1	2	3	4	5	6	7	8	9	10
Vout (VDC)	23.76	23.52	23.28	23.04	22.8	22.56	22.32	22.08	21.84	21.6
Rt down (KΩ)	1288.521	791.049	563.771	433.571	349.197	290.076	246.346	212.69	185.986	164.281
Trim up %	1	2	3	4	5	6	7	8	9	10
Vout (VDC)	24.24	24.48	24.72	24.96	25.2	25.44	25.68	25.92	26.16	26.4
Rt up (KΩ)	794.55	175.609	90.778	57.086	39.001	27.717	20.006	14.402	10.146	6.803

Vout = 48V

Trim down %	1	2	3	4	5	6	7	8	9	10
Vout (VDC)	47.52	47.04	46.56	46.08	45.6	45.12	44.64	44.16	43.68	43.2
Rt down (KΩ)	3783.16	2211.247	1550.307	1186.348	955.925	796.94	680.629	591.844	521.847	465.245
Trim up %	1	2	3	4	5	6	7	8	9	10
Vout (VDC)	48.48	48.96	49.44	49.92	50.4	50.88	51.36	51.84	52.32	52.8
Rt up (KΩ)	545.949	186.38	108.944	75.147	56.209	44.097	35.684	29.5	24.762	21.017

NOTE: 1. Datasheets are updated as needed and as such, specifications are subject to change without notice. Once printed or downloaded, datasheets are no longer controlled by Aimtec; refer to www.aimtec.com for the most current product specifications. 2. Product labels shown, including safety agency certifications on labels, may vary based on the date manufactured. 3. Mechanical drawings and specifications are for reference only. 4. All specifications are measured at an ambient temperature of 25°C, humidity<75%, nominal input voltage and at rated output load unless otherwise specified. 5. Aimtec may not have conducted destructive testing or chemical analysis on all internal components and chemicals at the time of publishing this document. CAS numbers and other limited information are considered proprietary and may not be available for release. 6. This product is not designed for use in critical life support systems, equipment used in hazardous environments, nuclear control systems or other such applications which necessitate specific safety and regulatory standards other the ones listed in this datasheet. 7. Warranty is in accordance with Aimtec's standard Terms of Sale available at www.aimtec.com.

X-ON Electronics

Largest Supplier of Electrical and Electronic Components

Click to view similar products for [Isolated DC/DC Converters](#) category:

Click to view products by [Aimtec](#) manufacturer:

Other Similar products are found below :

[PSL486-7LR](#) [Q48T30020-NBB0](#) [18362](#) [JAHW100Y1](#) [SPB05C-12](#) [SQ24S15033-PS0S](#) [18952](#) [19-130041](#) [CE-1003](#) [CE-1004](#) [MAU228](#) [J80-0041NL](#) [DFC15U48D15](#) [XGS-1205](#) [SPB05B-15](#) [L-DA20](#) [DCG40-5G](#) [XKS-2405](#) [DPA423R](#) [VI-N61-CM](#) [VI-R5022-EXWW](#) [PSC128-7iR](#) [RPS8-350ATX-XE](#) [vi-m13-cw-03](#) [VI-LN2-EW](#) [AK-1615-7R](#) [VI-L52-EW](#) [VI-L53-CV](#) [VI-LC63-EV](#) [AM2D-051212DZ](#) [24IBX15-50-0ZG](#) [HZZ01204-G](#) [SPU02L-09](#) [SPU02M-09](#) [SPU02N-09](#) [QUINT4-BUFFER/24DC/40](#) [QUINT4-CAP/24DC/5/4KJ](#) [VEFT1-S12-S12-SMT](#) [73-551-5039I](#) [DFC15U48D15G](#) [PV40-29B24](#) [SEN-6471-1EM](#) [URF4824QB-150WHR3](#) [AHV2815DF/HBB](#) [MI-LC21-IX](#) [150035222](#) [PAH-48/8.5-D48NB1-C](#) [BM3020-7A](#) [QRS2050P025R06](#) [RJ-0509S](#)