

Click to
ORDER
samples

AME15-277PEVZ



The AME15-277PEVZ is a whole new AC/DC converter that offers much greater cost effectiveness due to material normalization and production automation also leading to improved reliability and performance. Offering a commercial input voltage range of 85-305VAC and an output voltage range from 3.3-24V, this series will offer many benefits to your new system design.

This new series offers great operating temperatures from -40°C to 85°C, also features an isolation of 4200VAC for improved reliability and system safety. Furthermore, a higher MTBF of 500,000h, output short circuit protection (OSCP), output over-current protection (OCP) and an output over-voltage protection (OVP) come standard with the series.

The AME15-277PEVZ is perfect for street lighting controls, grid power, EVSE, industrial controls, UPS, battery storage system and energy management applications.

Features

- Universal Input: 85 - 305VAC/100 - 430VDC
- Operating Temp: -40 °C to +85 °C
- High isolation voltage: 4200VAC
- Low ripple & noise, 50mV(p-p), typ.
- Output short circuit, over-current, over-voltage protection
- Regulated Output

Summary

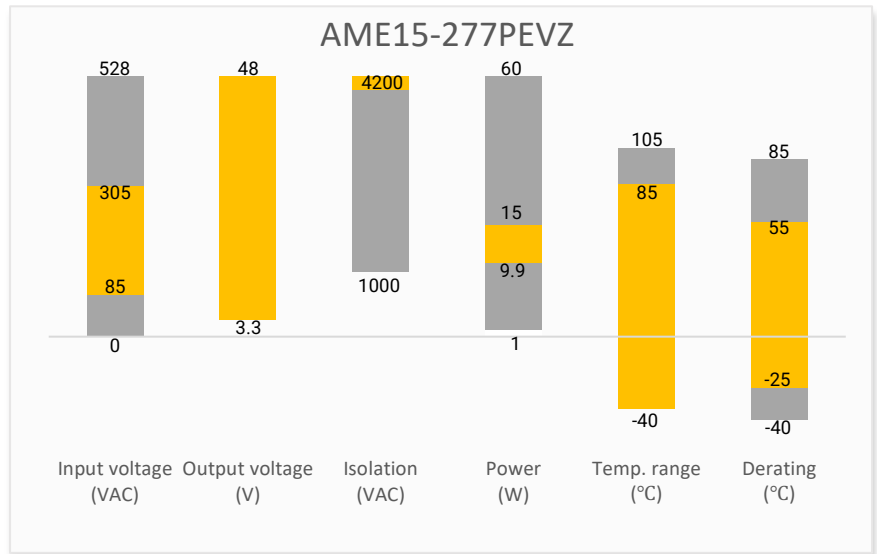

Training

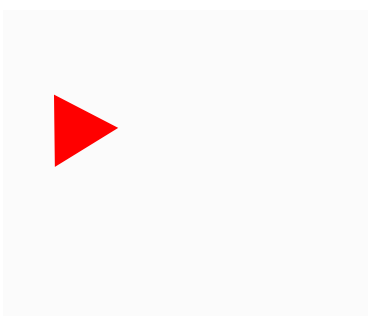

Product Training Video
(click to open)

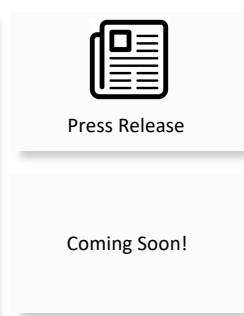

Application Notes

Applications



Power Grid



Industrial



Telecom



Instrumentation

Models & Specifications

Single Output							
Model	Input Voltage (VAC/Hz)	Input Voltage (VDC)	Max Output wattage (W)	Output Voltage (V)	Output Current max (A)	Maximum capacitive load (μF)	Efficiency @ 230VAC (%)
AME15-3S277PEVZ	85-305/47-63	100-430	9.9	3.3	3	30000	77
AME15-5S277PEVZ	85-305/47-63	100-430	14	5	2.8	16000	79
AME15-9S277PEVZ ✖	85-305/47-63	100-430	15	9	1.67	5500	78
AME15-12S277PEVZ	85-305/47-63	100-430	15	12	1.25	4500	82
AME15-15S277PEVZ	85-305/47-63	100-430	15	15	1	4000	82
AME15-24S277PEVZ	85-305/47-63	100-430	15	24	0.625	800	83
AME15-48S277PEVZ ✖	85-305/47-63	100-430	15	48	0.32	400	85

Note: Use suffix "ST" for chassis and suffix "STD" for DIN-Rail mounting (ex. AME15-3S277PEVZ-ST is chassis mounting and AME15-3S277PEVZ-STD is DIN-Rail mounting version).

Input Specifications					
Parameters	Conditions	Minimum	Typical	Maximum	Units
Current	115VAC			0.37	A
	230VAC			0.22	A
Inrush current	115VAC		16		A
	230VAC		30		A
Leakage current	270V/50Hz			0.25	mA (RMS)
External fuse	slow blow type,300V		2		A

Output Specifications				
Parameters	Conditions	Typical	Maximum	Units
Voltage accuracy	3.3V output	±3		%
	Others	±2		%
Line regulation	Full load	±0.5		%
Load regulation	0-100% load	±1		%
Ripple & Noise*	20MHz bandwidth	50	100	mV _{p-p}
Hold up time	115VAC	5		ms
	230VAC	40		ms

* Ripple and Noise are measured at 20MHz bandwidth by using the referenced Application circuit.

Isolation Specifications				
Parameters	Conditions	Typical	Rated	Units
Tested I/O voltage	60 sec, leakage current < 5mA		4200	VAC
Tested Input to PE voltage	60 sec, leakage current < 5mA		2500	VAC

Tested Output to PE voltage	60 sec, leakage current < 5mA		1250	VAC
Impulse voltage (I/O, Input/PE, Output/PE)	Apply 6kV impulse test voltage. Add 1.2/50us impact waveform, including three positive impulse and three negative impulse, whose time interval is no less than 5 seconds.		6000	V
Insulation resistance (I/O, Input/PE, Output/PE)	500VDC		≥ 100	MΩ

General Specifications				
Parameters	Conditions	Typical	Maximum	Units
Safety class	Class I			
Overvoltage category	OVC III; Per IEC 62477, 2000m			
Switching frequency		65		KHz
Over Current protection	Auto recovery	≥ 150		% of I _{out}
Over voltage protection	3.3V / 5V V _{out}		7.5	VDC
	9V V _{out}		15	VDC
	12V /15V V _{out}		20	VDC
	24V V _{out}		30	VDC
	48V V _{out}		60	VDC
Short circuit protection	Hiccup, Continuous, Auto recovery			
Operating temperature	See derating graph	-40 to +85		°C
Storage temperature		-40 to +105		°C
Lead temperature	Wave soldering	260 ± 5 °C; time : 5 - 10s		
	Hand soldering	360 ± 10 °C; time : 3 - 5s		
Power consumption	230VAC, Others		0.3	W
	230VAC, 48V V _{out}		0.5	W
Power derating	-40 °C ~ -25 °C	4		% / °C
	55 °C ~ 70 °C	2.67		% / °C
	70 °C ~ 85 °C	1.33		% / °C
	85VAC ~ 100VAC	1.67		% / VAC
	277VAC ~ 305VAC	0.72		% / VAC
	2000m – 5000m	6.67		% / Km
Temperature coefficient		±0.02		% / °C
Cooling	Free air convection			
Humidity	Non-condensing		95	% RH
Case material	Heat resistant black Plastic (flammability to UL 94V-0)			
Weight	PCB mountable models		95	g
	With optional -ST mounting plate:		140	
	With optional -STD mounting plate:		180	
Dimensions (L x W x H)	PCB mountable models	2.44 x 1.77 x 0.89 inches (62.0 x 45.0 x 22.5mm)		
	With optional -ST mounting plate	3.78 x 2.13 x 1.22 inches (96.1 x 54.0 x 31.0mm)		
	With optional -STD mounting plate	3.78 x 2.13 x 1.40 inches (96.1 x 54.0 x 35.6mm)		
MTBF	> 500 000 hrs (MIL-HDBK -217F, t _a =+25°C)/Full Load			
NOTE: All specifications in this datasheet are measured at an ambient temperature of 25°C, humidity<75%, nominal input voltage and at rated output load unless otherwise specified.				

Safety Specifications

Parameters

Agency approvals	CE EN62368-1; cULus UL 62368-1(With exception of models marked with ✖)	
Standards	Information technology Equipment	Designed to meet IEC/UL 62368-1, IEC 62477-1
	EMC - Conducted and radiated emission	CISPR32 / EN55032, class B
	Electrostatic Discharge Immunity	IEC 61000-4-2 Contact $\pm 8\text{KV}$ / Air $\pm 15\text{KV}$, Criteria A
	RF, Electromagnetic Field Immunity	IEC 61000-4-3 10V/m, Criteria A
	Electrical Fast Transient/Burst Immunity	IEC 61000-4-4 $\pm 4\text{KV}$, Criteria A
	Surge Immunity	IEC 61000-4-5 L-L $\pm 2\text{KV}$ /L-G $\pm 4\text{KV}$, Criteria A
		IEC 61000-4-5 L-L $\pm 4\text{KV}$ /L-G $\pm 6\text{KV}$, with EMC recommended circuit, Criteria A
	CS, Conducted Disturbance Immunity	IEC 61000-4-6 10Vr.m.s, Criteria A
	PFMF, Power Frequency Magnetic Field	IEC 61000-4-8 10A/m, Criteria A
Voltage dips, Short Interruptions Immunity	IEC 61000-4-11 0%, 70%, Criteria B	

Derating

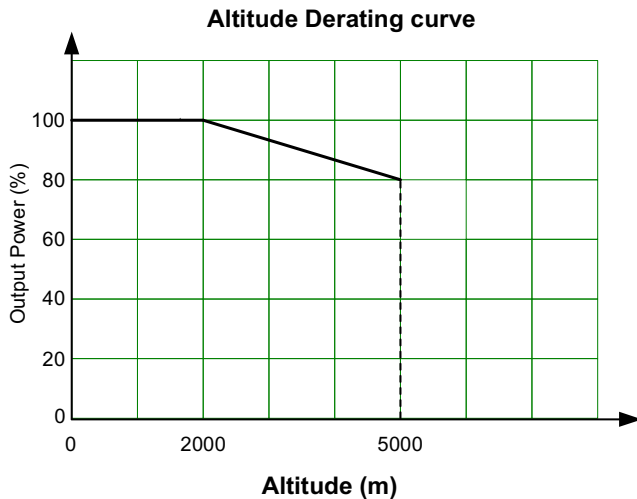
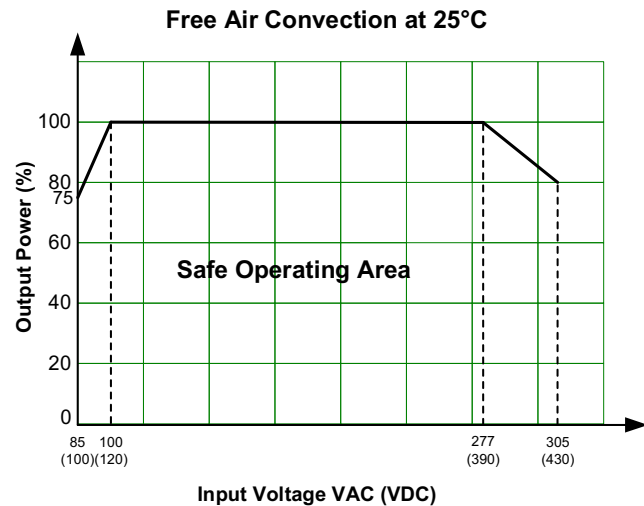
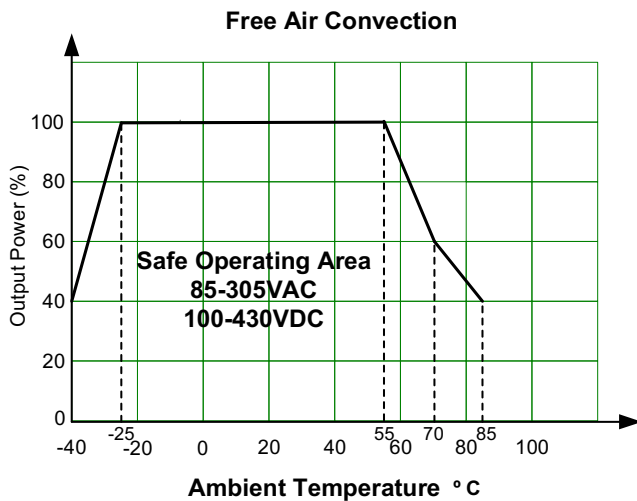

Typical Application Circuit

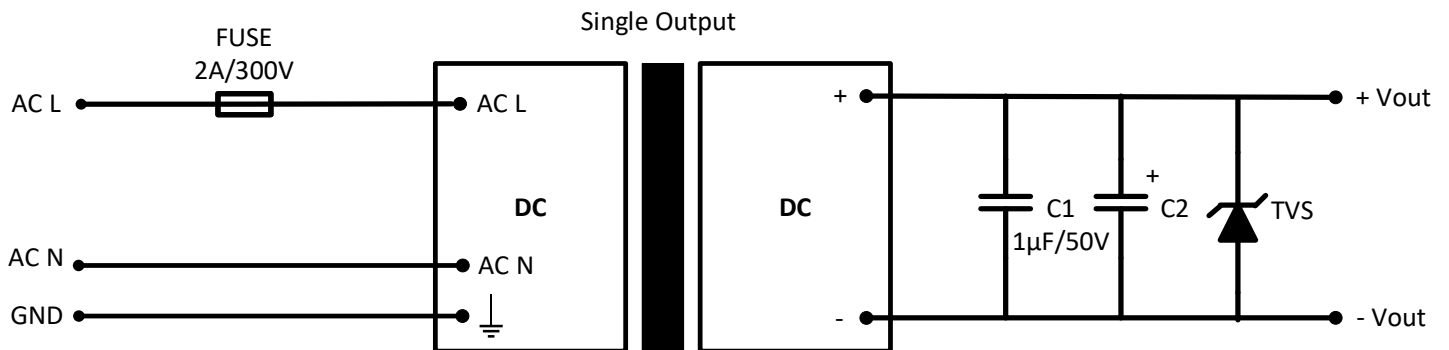

Model	C2	TVS
3.3 / 5V Vout	680 µF / 25V	SMBJ7.0A
9 Vout	470 µF / 25V	SMBJ12A
12 / 15 Vout	220 µF / 25V	SMBJ20A
24 Vout	68 µF / 35V	SMBJ30A
48 Vout	33 µF / 63V	SMBJ64A

Output Filter Components:

We recommend using an electrolytic capacitor with high frequency, and low ESR rating for C2. C1 is a ceramic capacitor used for filtering high-frequency noise and TVS is a recommended suppressor diode.

EMC Recommended Circuit

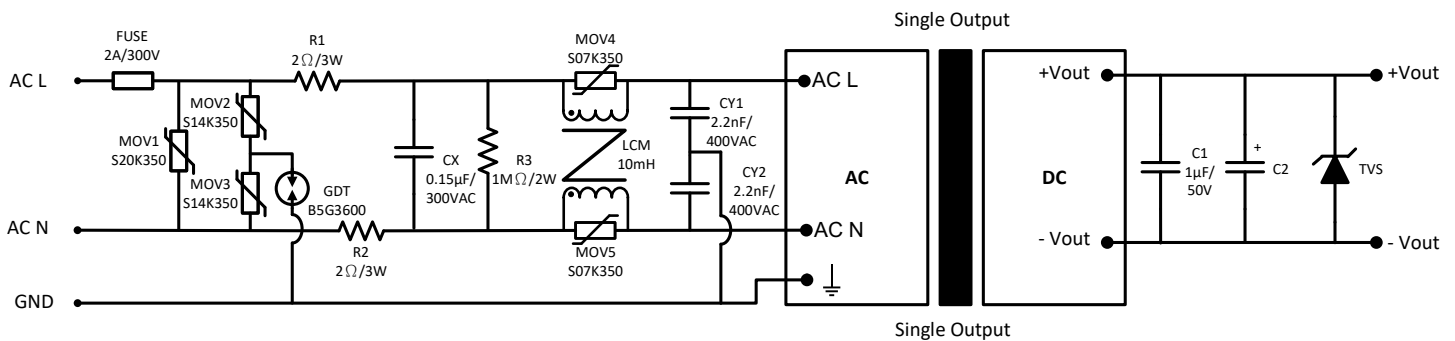

NOTE: R1 & R2 should be wire-wound resistors

Dimensions

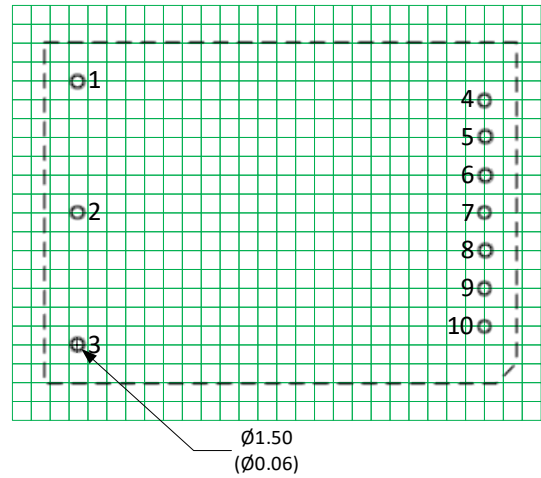
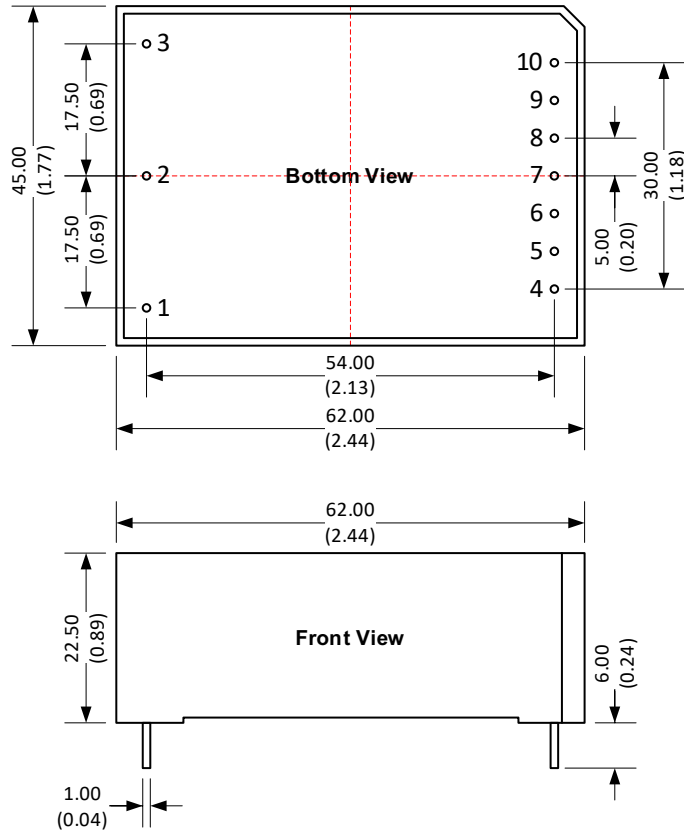

Note : Grid 2.54*2.54 mm

Notes:
All dimensions are typical in millimeters (inches).
Pin diameter tolerances : ± 0.10 (± 0.004)
General tolerance : ± 0.50 (± 0.02)

Pin Output Specifications			
Pin	Single	Pin	Single
1	Ground	6	No pin
2	AC Input (N)	7	No pin
3	AC Input (L)	8	No pin
4	No pin	9	+V Output
5	-V Output	10	No pin

Dimensions with ST Optional

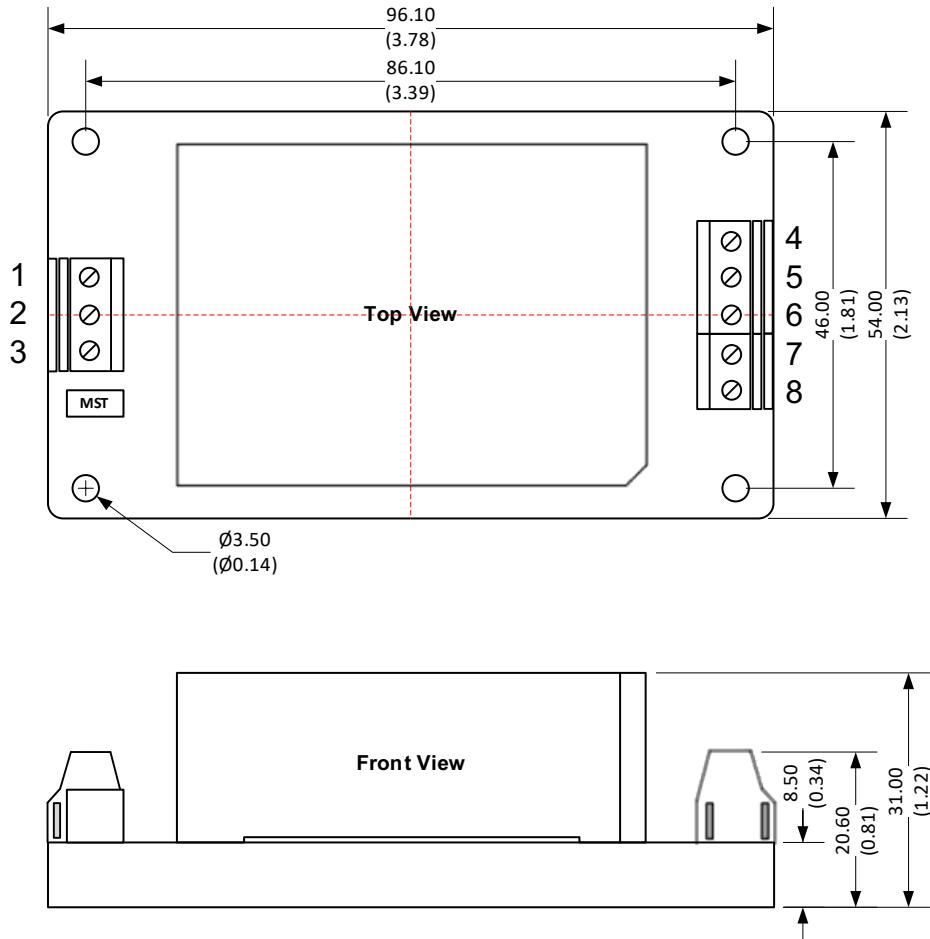

Notes:
 All dimensions are typical in millimeters (inches).
 Wire range : 24-12 AWG
 Tightening torque : Max 0.4 N.m
 General tolerance ± 1.00 : (± 0.04)

Pin Output Specifications			
Pin	Single	Pin	Single
1	Ground	5	NC
2	AC Input (N)	6	NC
3	AC Input (L)	7	NC
4	-V Output	8	+V Output

Dimensions with STD Optional

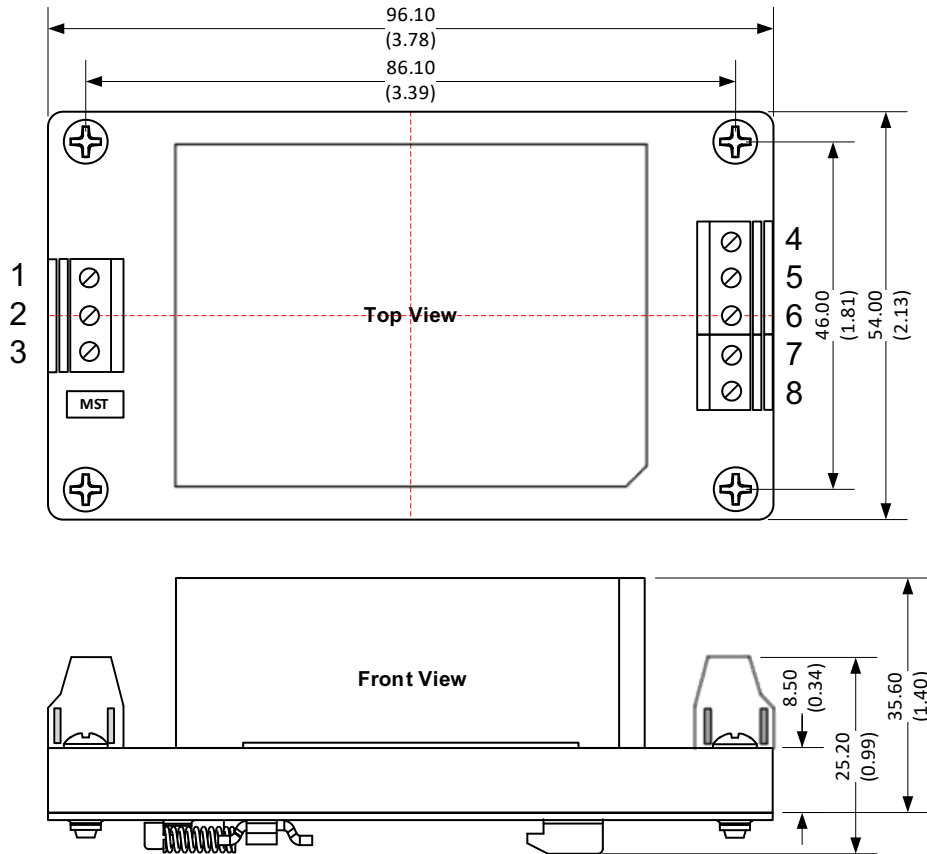

Notes:

- All dimensions are typical in millimeters (inches).
- Mounting rail : TS35, rail need to connect safety ground
- Wire range : 24-12 AWG
- Tightening torque : Max 0.4 N.m
- General tolerance ± 1.00 : (± 0.04)

Pin Output Specifications			
Pin	Single	Pin	Single
1	Ground	5	NC
2	AC Input (N)	6	NC
3	AC Input (L)	7	NC
4	-V Output	8	+V Output

NOTE: 1. Datasheets are updated as needed and as such, specifications are subject to change without notice. Once printed or downloaded, datasheets are no longer controlled by Aimtec; refer to www.aimtec.com for the most current product specifications. 2. Product labels shown, including safety agency certifications on labels, may vary based on the date manufactured. 3. Mechanical drawings and specifications are for reference only. 4. All specifications are measured at an ambient temperature of 25°C, humidity < 75%, nominal input voltage and at rated output load unless otherwise specified. 5. Aimtec may not have conducted destructive testing or chemical analysis on all internal components and chemicals at the time of publishing this document. CAS numbers and other limited information are considered proprietary and may not be available for release. 6. This product is not designed for use in critical life support systems, equipment used in hazardous environments, nuclear control systems or other such applications which necessitate specific safety and regulatory standards other than the ones listed in this datasheet. 7. Warranty is in accordance with Aimtec's standard Terms of Sale available at www.aimtec.com.

X-ON Electronics

Largest Supplier of Electrical and Electronic Components

Click to view similar products for [AC/DC Power Modules](#) category:

Click to view products by [Aimtec](#) manufacturer:

Other Similar products are found below :

[ERP-350-12](#) [RAC05-05SK/PD3/H](#) [AMEOF65-12SJZ](#) [AMEOFL10-24S480PEVZ-B](#) [AMEOFL10-3S480PEVZ-B](#) [AMEL10-12S277HAVZ-B](#)
[AMEOFL5-3S480HANZ-B](#) [AMEOFL5-5S480HANZ-B](#) [AMEOFL5-12S480HANZ-B](#) [RAC05-12SK/PD3/H](#) [AME30-9S480JZ-B](#) [AMEL20-3S277HAVZ-B](#) [AMEL45-24SJZ](#) [AMEL30-12S277HAVZ](#) [AMEL30-15S277HAVZ](#) [AMEL30-3S277HAVZ](#) [AMEL30-5S277HAVZ](#)
[AMEL30-9S277HAVZ](#) [AMEM5-9S277HAVZ-B](#) [AMESP100-24S277NZ](#) [AMESP100-48S277NZ](#) [AMESP150-24S277NZ](#) [AMESP200-24S277NZ](#) [AMESP320-24S277NZ](#) [AMESP320-48S277NZ](#) [AMESP75-12S277NZ](#) [AMESP75-24S277NZ](#) [AMESP75-48S277NZ](#) [AME30-3S480JZ-B](#) [ZP05S1200WB](#) [AME30-5S480JZ-B](#) [AME10-24S277PEVZ](#) [AMEL60-24SJZ](#) [AMEL60-48SJZ](#) [AMEM3-15S277HAVZ-B](#)
[AMEM3-24S277HAVZ-B](#) [AMEM3-3S277HAVZ-B](#) [AMEM3-9S277HAVZ-B](#) [AMEM5-12S277HAVZ-B](#) [AMEM5-15S277HAVZ-B](#)
[AMEM5-5S277HAVZ-B](#) [AMEOF225-12SHAMJZ](#) [AMEL15-24S277HAVZ-B](#) [AMEL15-5S277HAVZ](#) [AMEL15-5S277HAVZ-ST](#) [AMEL20-12S277HAVZ-B](#) [AMEL20-24S277HAVZ-B](#) [AMEL20-24S277HAVZ-STD](#) [AMEOF450-24SHAMJZ](#) [AMEOF450-48SHAMJZ](#)