

Click to  
**ORDER**  
samples

**AMSROL10-NZ**

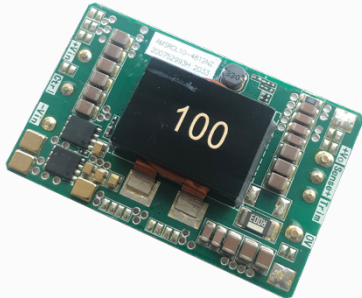

Open frame

Aimtec's AMSROL10-NZ series are non-isolated DC-DC converters with a 10A output current and wide input voltage range of 16-75VDC. They feature efficiency up to 97%, operating temperature of -40°C ~ +85°C, input under-voltage, output short-circuit & over-current protection.

The AMSROL10-NZ meets CLASS A of CISPR32/EN55032 emissions standards by adding the recommended external components. These models are widely used in applications such as battery powered systems and robotic field with a large fluctuation in a battery voltage & motor interference.

**Features**

- Input Range: 16VDC – 75VDC
- Operating Temp: -40 °C to +85 °C
- Low ripple & noise, up to 220mV(p-p) max.
- Efficiency up to 97%
- Adjustable output voltage
- Input under-voltage, output short circuit, over current protection
- Regulated single output

**Summary**

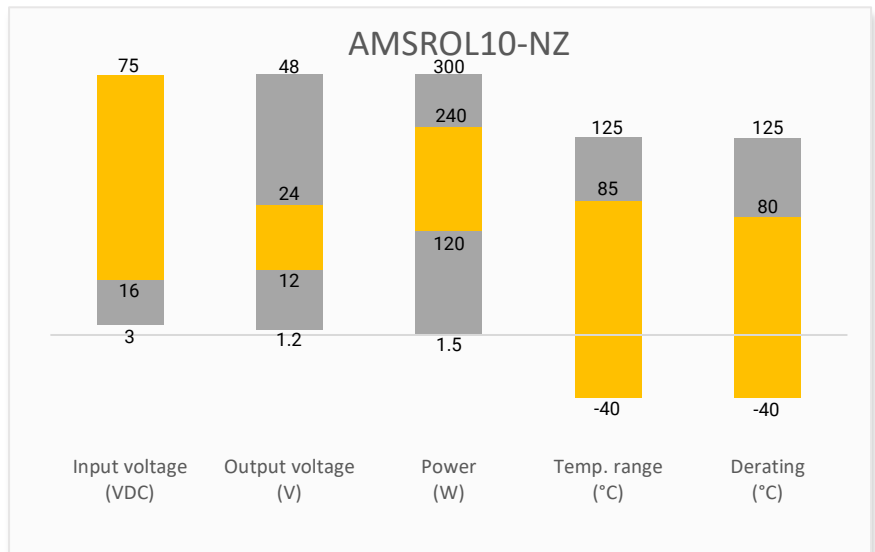

**Training**



Product Training Video  
(click to open)



Press Release

Coming Soon!

Application Notes

**Applications**



Power Grid



Industrial



Telecom



Instrumentation

## Models & Specifications

### Single Output

Model	Input Voltage (VDC)	Output Voltage (VDC)	Maximum Input Current (Nominal input voltage) (mA)		Output Current Max (A)	Maximum Capacitive Load ( $\mu$ F)	Efficiency (%) Full Load Typ.
			No Load	Full Load			
AMSROL10-4812NZ	48 (16 ~ 75)	12	80	2718	10	5500	95
AMSROL10-4824NZ	48 (30 ~ 75)	24	80	5320	10	3300	97

### Input Specification

Parameters	Conditions	Typical	Maximum	Units
Voltage range	See models table			VDC
Filter	Capacitance filter			
Absolute maximum rating	1 sec. max		80	VDC
Reflected ripple current	Nominal input voltage	200		mA pk-pk
Start-up voltage	Nominal 12V output model		16	VDC
	Nominal 24V output model		30	VDC
Under voltage protection	Nominal 12V output model	14		VDC
	Nominal 24V output model	27		VDC
Adjustable input starting/under voltage (Refer to design reference)	Nominal 12V output model,	$\geq 16$	75	VDC
	Nominal 24V output model	$\geq 30$	75	VDC
Ctrl *	Module ON	Ctrl pin open or pulled high (1.5~12VDC)		
	Module OFF	Ctrl pin pulled low to GND (0~0.8VDC)		
	Input current when OFF	2	10	mA

\* The Ctrl pin voltage is referenced to input GND.

### Output Specification

Parameters	Conditions	Typical	Maximum	Units
Voltage accuracy	0 ~ 100% load	$\pm 1$	$\pm 3$	%
Line regulation	Full load, LL - HL	$\pm 0.1$	$\pm 0.5$	%
Load regulation	5 ~ 100% load	$\pm 0.3$	$\pm 2$	%
Over current protection		130	190	% Iout
Short circuit protection	Continuous, Auto recovery			
Temperature coefficient	Full load		$\pm 0.03$	%/ °C
Ripple & Noise*	20MHz bandwidth	150	220	mV pk-pk
Trim			$\pm 10$	% Vout
Transient recovery time	25% load step change	200	500	$\mu$ S
Transient response deviation	25% load step change	$\pm 4$	$\pm 5$	%
Sense	Refer to remote sense application for details		105	% Vout

General Specifications				
Parameters	Conditions	Typical	Maximum	Units
Switching frequency	Nominal 12V output model	200		KHz
	Nominal 24V output model	250		KHz
Operating temperature	See derating graph	-40 to +85		°C
Storage temperature		-55 to +125		°C
Soldering temperature	Wave soldering, maximum duration 10 sec		260	°C
Cooling	Nature convection or forced convection			
Humidity	Non-condensing		95	% RH
Vibration	10-150Hz, 5G, 0.75mm, 90min, along X, Y and Z			
Weight		33		g
Dimensions (L x W x H)	2.33 x 1.48 x 0.51 inches (59.20 x 37.60 x 13.00mm)			
MTBF	> 1 000 000 hrs (MIL-HDBK -217F, t=+25°C)			

Safety Specifications		
Parameters		
Standards	EMC - Conducted and radiated emission	CISPR32/EN55032, CLASS A with recommended circuit
	Electrostatic Discharge Immunity	IEC 61000-4-2 Contact $\pm$ 6KV, Criteria B
	RF, Electromagnetic Field Immunity	IEC 61000-4-3 10V/m, Criteria A
	Electrical Fast Transient/Burst Immunity	IEC 61000-4-4 $\pm$ 2KV, Criteria A with recommended circuit
	Surge Immunity	IEC 61000-4-5 $\pm$ 2KV, Criteria B with recommended circuit
	RF, Conducted Disturbance Immunity	IEC 61000-4-6 10Vr.m.s, Criteria A

## Derating



### 12V output model

$$16V \leq V_{in} \leq 48V$$

Nature convection or forced convection

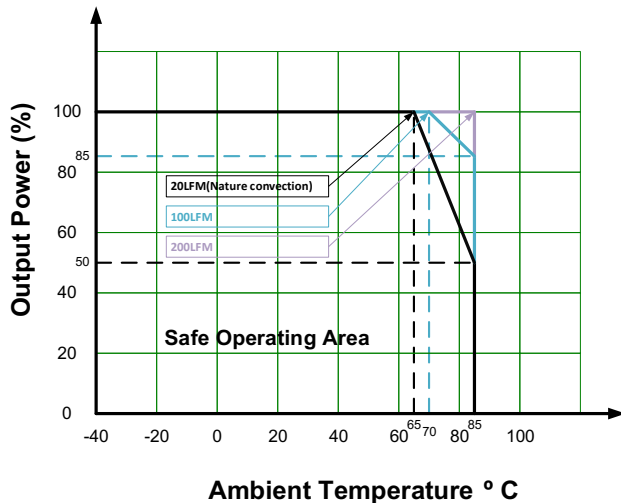

$$48V \leq V_{in} \leq 55V$$

Nature convection or forced convection

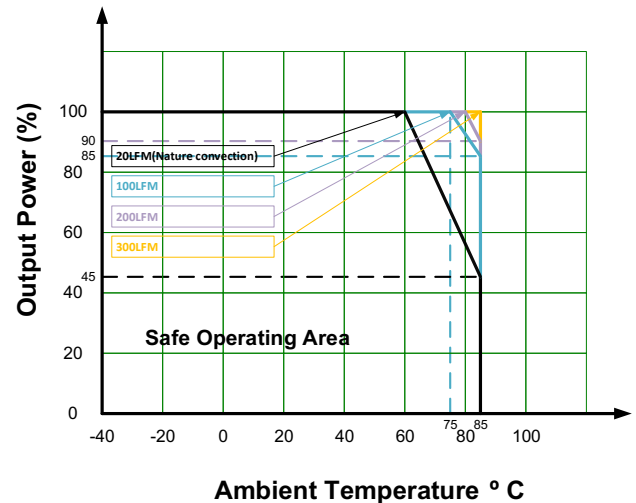

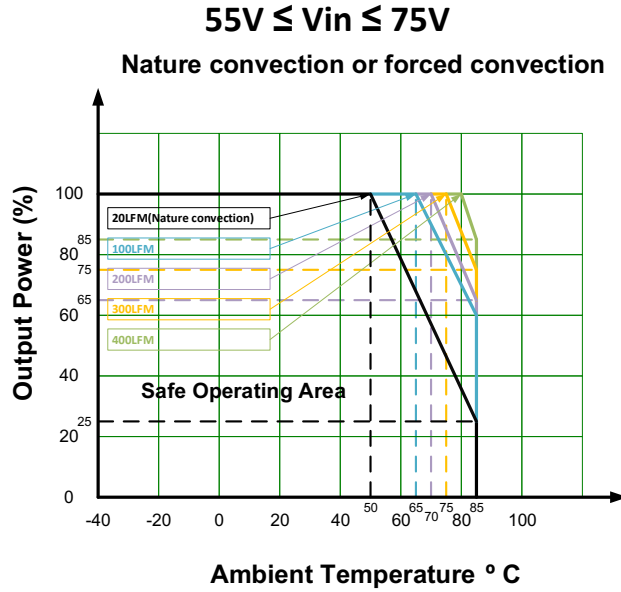

24V output model

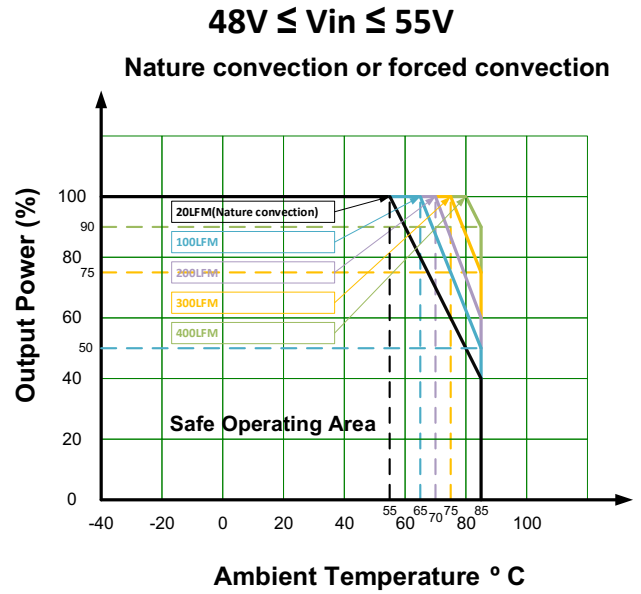
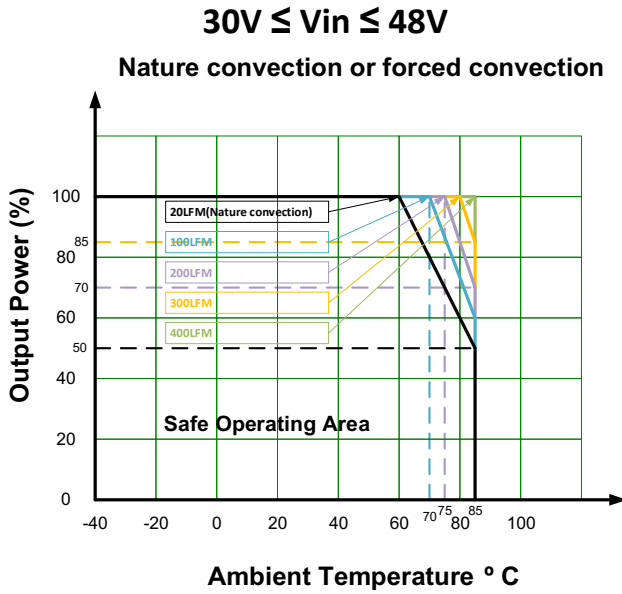

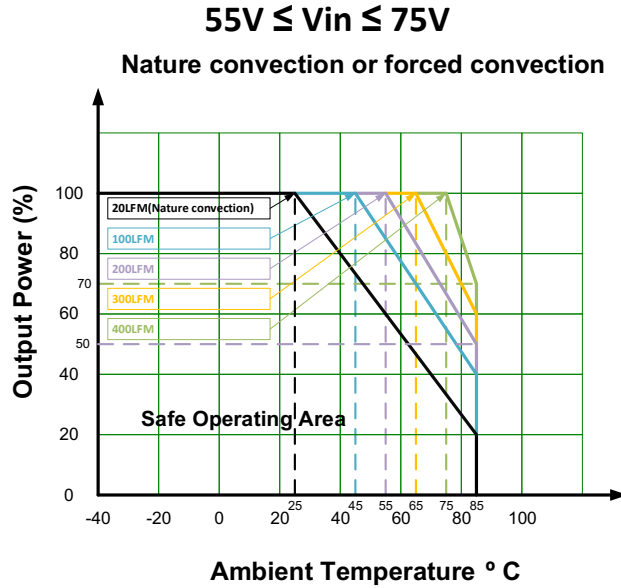

## Remote Sense Application



### Remote sense connection if not used

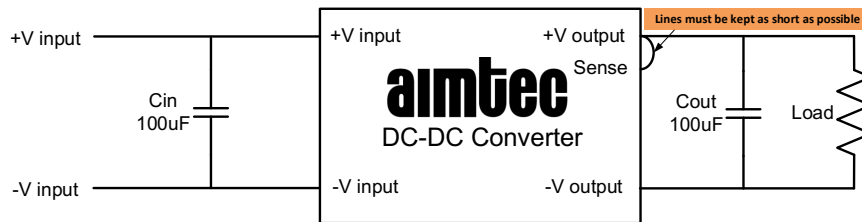

Notes:

1. Sense must be connected to +Vo at the DC-DC switching regulator if it is not used for remote regulation.
2. To avoid picking up noise, interference and/or cause unstable operation of the regulator, the connection between Sense and +Vo must be as short as possible.

### Remote sense connection used for compensation

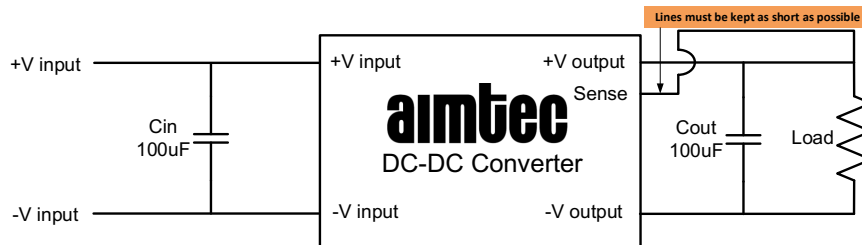

Notes:

1. Using long remote sense wire may cause unstable output, please contact technical support if long sense wires must be used.
2. Please ensure adequate cross section for PCB-trace and/or cables connecting the power supply module to the load to keep the voltage drop below 0.3V and make sure the power supply's output voltage remains within the specified range.
3. Large wire impedance may cause oscillation of the output voltage and/or increased ripple. Consult technical support or factory for further advice of sense operation.

## Typical Application Circuit

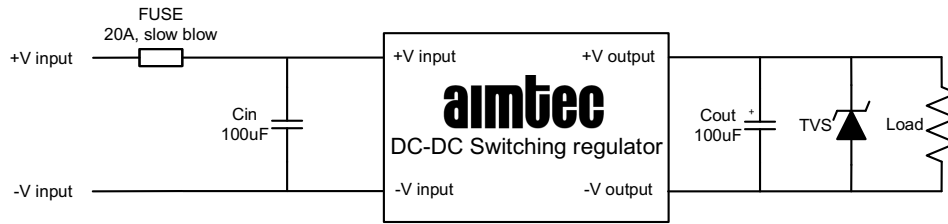

TVS : SMDJ14A (12V output model) / SMDJ28A (24V output model).

## EMC Recommended Circuit

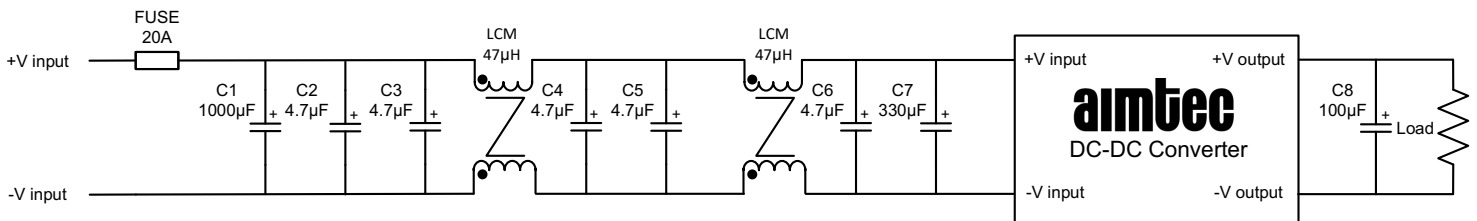

## Dimensions

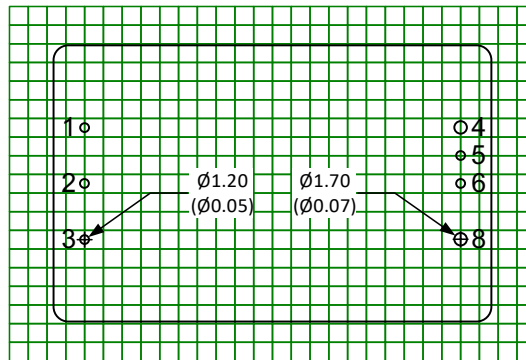
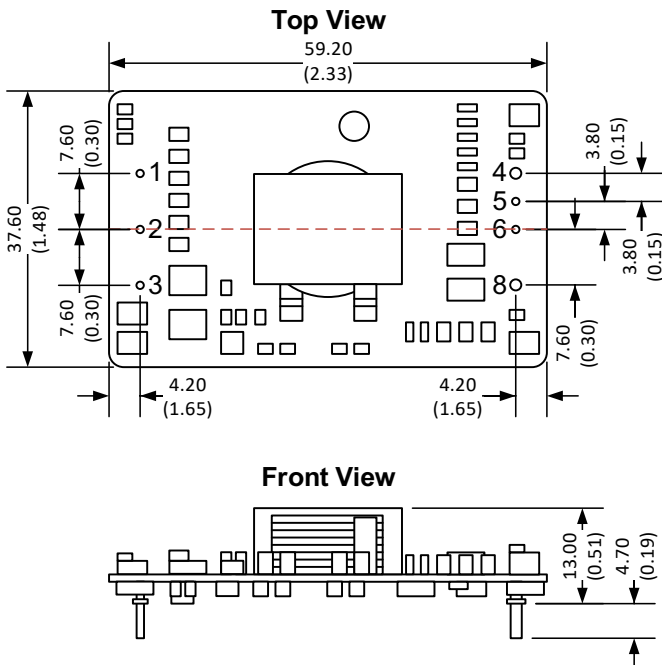

Note : Grid 2.54\*2.54 mm

Pin Out Specifications	
Pin	Single
1	+V Input
2	Ctrl
3	-V Input
4	+V Output
5	Sense
6	Trim
8	-V Output

### Notes:

All dimensions are typical in millimeters (inches).

Pin 1,2,3,5,6 diameter : 1.0 (0.04)

Pin 4,8 diameter : 1.5 (0.06)

Pin diameter tolerance : ±0.1 (±0.004)

Stand-off tolerance ±0.50 (±0.02)

## Trimming

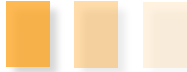

Output voltage can be externally trimmed by utilizing the methods as shown below

### Fixed Resistor

### Variable Potentiometer

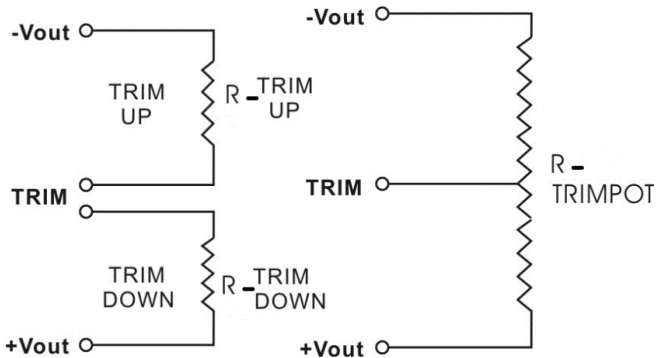

Leave open if not used.

## AMSROL10-4812NZ

Trim down %	1	2	3	4	5	6	7	8	9	10
Vout (VDC)	11.880	11.760	11.640	11.520	11.400	11.280	11.160	11.040	10.920	10.800
Rt down (KΩ)	22228.051	12632.653	8742.977	6636.153	5314.955	4409.004	3749.121	3247.040	2852.201	2533.562
Trim up %	1	2	3	4	5	6	7	8	9	10
Vout (VDC)	12.120	12.240	12.360	12.480	12.600	12.720	12.840	12.960	13.080	13.200
Rt up (KΩ)	3336.021	1224.275	714.417	484.966	354.489	270.308	211.497	168.087	134.731	108.297

## AMSROL10-4824NZ

Trim down %	1	2	3	4	5	6	7	8	9	10
Vout (VDC)	23.760	23.520	23.280	23.040	22.800	22.560	22.320	22.080	21.840	21.600
Rt down (KΩ)	31665.034	15574.887	10232.492	7565.213	5966.097	4900.540	4139.683	3569.180	3125.538	2770.676
Trim up %	1	2	3	4	5	6	7	8	9	10
Vout (VDC)	24.240	24.480	24.720	24.960	25.200	25.440	25.680	25.920	26.160	26.400
Rt up (KΩ)	1002.593	457.394	274.952	183.598	128.743	92.155	66.011	46.399	31.143	18.936

## Adjustable input Starting/Under Voltage and Resistor calculation

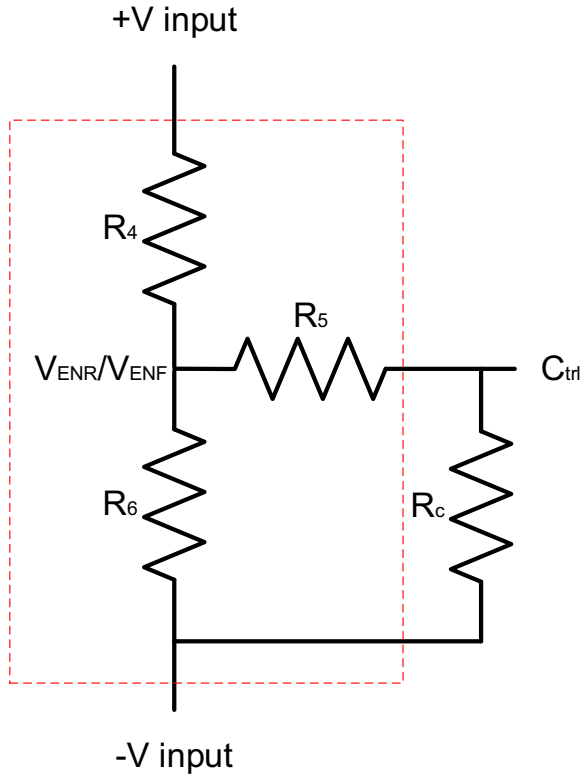

Adjustable input Starting/Under Voltage resistor connection  
(dashed line shows internal resistor network)

Calculation resistor of Adjustable input Starting (Under-voltage) Voltage:

$$R_c = \frac{bR_5}{R_5 - b} - R_6 \quad b = \frac{V_{EN}}{V_{in} - V_{EN}} \times R_4$$

R<sub>c</sub> : resistor of Adjustable input Starting (Under-voltage) Voltage  
b : self-defined parameter

When V<sub>EN</sub>=V<sub>ENR</sub>, V<sub>in</sub> is actual starting voltage required for input  
When V<sub>EN</sub>=V<sub>ENF</sub>, V<sub>in</sub> is actual under-voltage required for input

Vout(VDC)	R4(KΩ)	R5(KΩ)	R6(KΩ)	VENR(V)	VENF(V)
12	100	8.93	0.1	1.22	1.09
24	100	4.32	0.1	1.22	1.09

**NOTE:** 1. Datasheets are updated as needed and as such, specifications are subject to change without notice. Once printed or downloaded, datasheets are no longer controlled by Aimtec; refer to [www.aimtec.com](http://www.aimtec.com) for the most current product specifications. 2. Product labels shown, including safety agency certifications on labels, may vary based on the date manufactured. 3. Mechanical drawings and specifications are for reference only. 4. All specifications are measured at an ambient temperature of 25°C, humidity<75%, nominal input voltage and at rated output load unless otherwise specified. 5. Aimtec may not have conducted destructive testing or chemical analysis on all internal components and chemicals at the time of publishing this document. CAS numbers and other limited information are considered proprietary and may not be available for release. 6. This product is not designed for use in critical life support systems, equipment used in hazardous environments, nuclear control systems or other such applications which necessitate specific safety and regulatory standards other the ones listed in this datasheet. 7. Warranty is in accordance with Aimtec's standard Terms of Sale available at [www.aimtec.com](http://www.aimtec.com).



## X-ON Electronics

Largest Supplier of Electrical and Electronic Components

*Click to view similar products for [Isolated DC/DC Converters](#) category:*

*Click to view products by [Aimtec](#) manufacturer:*

Other Similar products are found below :

[ESM6D044440C05AAQ](#) [FMD15.24G](#) [PSL486-7LR](#) [Q48T30020-NBB0](#) [18362](#) [JAHW100Y1](#) [SPB05C-12](#) [SQ24S15033-PS0S](#) [19-130041](#)  
[CE-1003](#) [GQ2541-7R](#) [RDS180245](#) [MAU228](#) [J80-0041NL](#) [DFC15U48D15](#) [XGS-0512](#) [XGS-1205](#) [XGS-1212](#) [XGS-2412](#) [XGS-2415](#) [XKS-](#)  
[1215](#) [06322](#) [NCT1000N040R050B](#) [SPB05B-15](#) [SPB05C-15](#) [L-DA20](#) [DCG40-5G](#) [QME48T40033-PGB0](#) [XKS-2415](#) [XKS-2412](#) [XKS-1212](#)  
[XKS-1205](#) [XKS-0515](#) [XKS-0505](#) [XGS-2405](#) [XGS-1215](#) [XGS-0515](#) [73-551-5038I](#) [AK1601-9RT](#) [VI-N61-CM](#) [VI-R5022-EXWW](#) [PSC128-](#)  
[7iR](#) [RPS8-350ATX-XE](#) [DAS1004812](#) [PQA30-D24-S24-DH](#) [VI-M5F-CQ](#) [VI-LN2-EW](#) [VI-PJW01-CZY](#) [CK2540-9ERT](#) [AK-1615-7R](#)