

1 • ROW

Strip Connectors

Board to Cable

.050"

MA-1

MA-141-004-261-A03WS

2 thru 60 Contacts

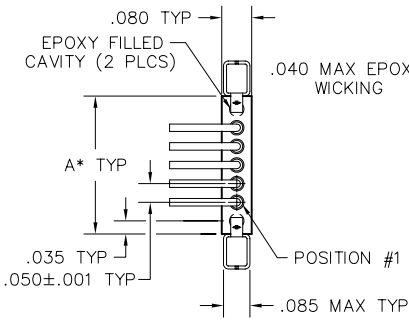

TERMINATION VIEW

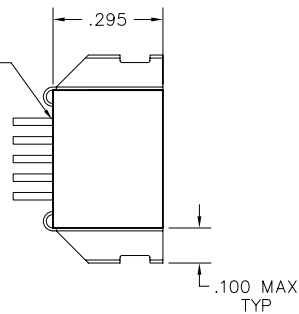

PLUG

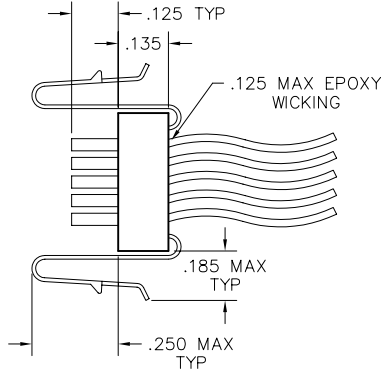

RECEPTACLE

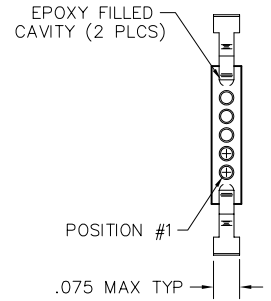

TERMINATION VIEW

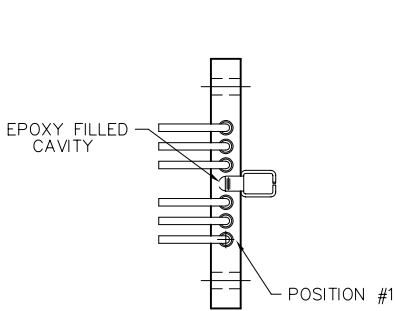

TERMINATION VIEW

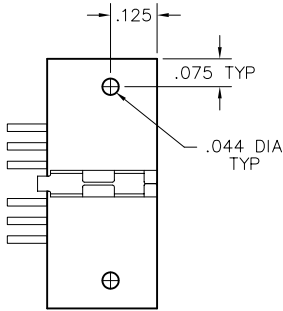

PLUG

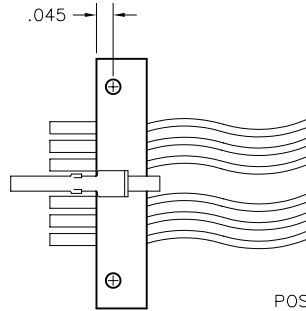

RECEPTACLE

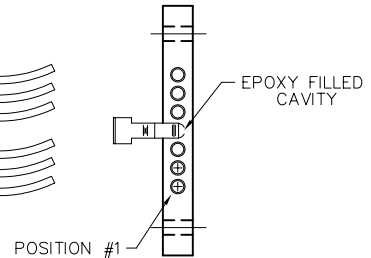

TERMINATION VIEW

OPTIONAL MOUNTING HOLES

DIMENSIONS

To determine connector length (Dim "A"):

Multiply the number of cavities in one row by .050"	. "
Add fixed end lengths (constant, .010" x 2)	0.02"
Add .150" for each mounting hole	. "
Total Length:	. "

Notes:

Length over 2" may require support to insure alignment.
 When using one lock screw, use centermost available hole.
 * = Maximum length is 3.020". Maximum number of contacts must be reduced to accommodate hardware and mounting holes.

LEAD CONFIGURATION OPTIONS

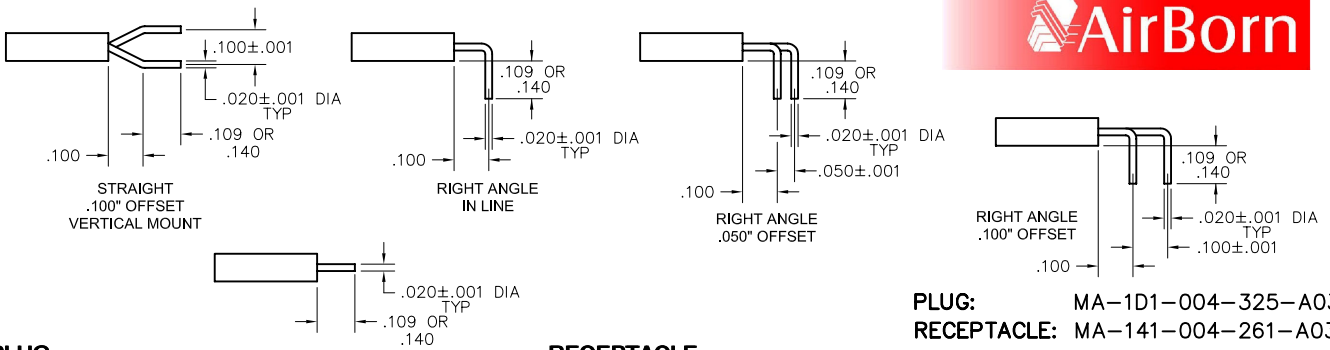

PLUG: MA-1D1-004-325-A0300
RECEPTACLE: MA-141-004-261-A03WS
 XX-XXX-XXX-XXX-XXXXX

PLUG		RECEPTACLE	
SERIES			
MA .050" Microminiature Strip Connector		MA .050" Microminiature Strip Connector	
BODY			
1 1-Row		1 1-Row	
BODY STYLE: (Material: Polyphenylene sulfide)		BODY STYLE: (Material: Polyphenylene sulfide)	
11 Plug, straight, with mounting holes		21 Receptacle, straight, with mounting holes	
31 Plug, straight, without mounting holes		41 Receptacle, straight, without mounting holes	
51 Plug, right angle, .050" offset, with mounting holes		61 Receptacle, right angle, .050" offset, with mounting holes	
71 Plug, right angle, .100" offset, with mounting holes		81 Receptacle, right angle, .100" offset, with mounting holes	
91 Plug, right angle, .050" offset, without mounting holes		A1 Receptacle, right angle, .050" offset, without mounting holes	
B1 Plug, right angle, .100" offset, without mounting holes		C1 Receptacle, right angle, .100" offset, without mounting holes	
D1 Plug, right angle, in line, with mounting holes		E1 Receptacle, right angle, in line, with mounting holes	
F1 Plug, right angle, in line, without mounting holes		G1 Receptacle, right angle, in line, without mounting holes	
H1 Plug, straight, .100" offset, without mounting holes		J 1 Receptacle, straight, .100" offset, without mounting holes	
SIZE			
XXX 002 - 060		XXX 002 - 060	
Note: Maximum number of contacts is reduced when using hardware or mounting holes. See dimension chart on M-13.			
CONTACTS			
TYPE CONTACTS/TERMINATIONS:		TYPE CONTACTS/TERMINATIONS:	
11 Pin, straight, solder cup		21 Socket, straight, solder cup	
12 Pin, straight, PCB leads, .109"		22 Socket, straight, PCB leads, .109"	
13 Pin, straight, PCB leads, .140"		23 Socket, straight, PCB leads, .140"	
14 Pin, straight, .500" pigtails (.018 dia)		24 Socket, straight, .500" pigtails (.018 dia)	
15 Pin, straight, 1.000" pigtails (.018 dia)		25 Socket, straight, 1.000" pigtails (.018 dia)	
16 Pin, straight, crimped wire		26 Socket, straight, crimped wire	
32 Pin, right angle, PCB leads, .109"		43 Socket, right angle, PCB leads, .109"	
33 Pin, right angle, PCB leads, .140"		44 Socket, right angle, PCB leads, .140"	
PLATING OPTIONS:		PLATING OPTIONS:	
1 50 μ" Au contacts (crimp wire)		1 50 μ" Au contacts (crimp wire)	
3 50 μ" Au contacts; 10 μ" Au terminations (solder cup, pigtail, PCB leads)		3 50 μ" Au contacts; 10 μ" Au terminations (solder cup, pigtail, PCB leads)	
5 50 μ" Au contacts; Sn/Pb alloy terminations (dip solder, pigtail, PCB leads) ☒		5 50 μ" Au contacts; Sn/Pb alloy terminations (dip solder, pigtail, PCB leads) ☒	
7 50 μ" Au contacts; SAC305 terminations (pigtail, PCB leads)		7 50 μ" Au contacts; SAC305 terminations (pigtail, PCB leads)	
HARDWARE			
STYLE OF HARDWARE:		STYLE OF HARDWARE:	
A00 None		A00 None	
A01-A49 Latch box, side mounted (cavity number location)		A01-A49 Latch spring, side mounted (cavity number location)	
A50 Latch boxes (two end cavities)**		A51 Latch springs (two end cavities)**	
A64 One guide hole (centered)*		A61 One guide pin (centered)*	
A65 One guide hole (first cavity)		A62 One guide pin (first cavity)	
A66 One guide hole (last cavity)		A63 One guide pin (last cavity)	
A68 Two guide holes (two end cavities)		A67 Two guide pins (two end cavities)	
A69 One threaded hole (centered)*		A72 One lockscrew (centered)*	
AHX One guide hole (cavity #2 - #9)		APX One guide pin (cavity #2 - #9)	
ATX One threaded hole (cavity #2 - #9)		ALX One lockscrew (cavity #2 - #9)	
POLARIZATION / WIRING:		POLARIZATION / WIRING	
00 None		00 None	
XX For wiring codes, see pages MA-3 & MA-4		XX For wiring codes, see pages MA-3 & MA-4	

* = To determine location, divide the total number of cavities by two and round to the next whole number, if result is a fraction. See page M-15.
 ** = Not available with mounting holes.
 See MA strip guidelines, page M-15, for location examples & visual clarification.
 ☒ = Option not RoHS compliant



Board mount connectors, right angle inline (.100") with mounting holes Side mount latch, centered

(5 electrical positions, 1 mechanical positions)

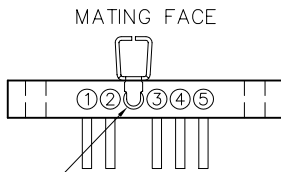
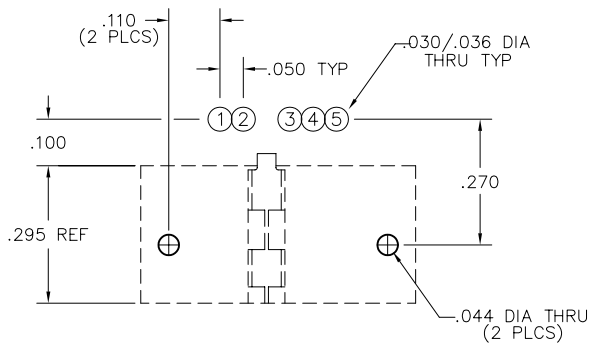

FILLED CAVITY

PLUG
MA-1D1-005-325-A0300

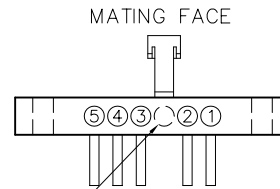
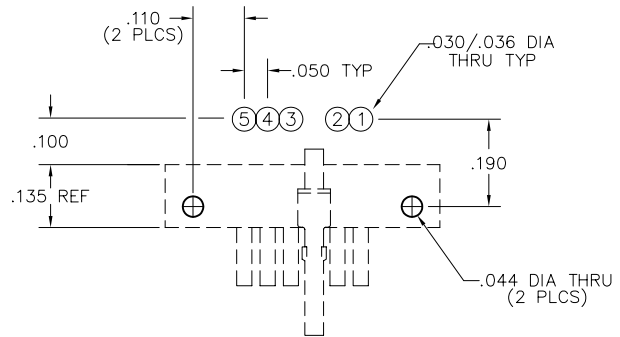

FILLED CAVITY

RECEPTACLE
MA-1E1-005-435-A0300

Crimped wire connectors, straight without mounting holes Side mount latch, centered

(5 electrical positions, 1 mechanical positions)

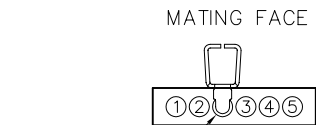

FILLED CAVITY

PLUG
MA-131-005-161-A03WA

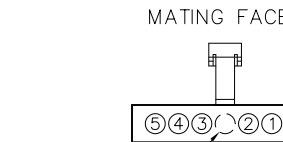

FILLED CAVITY

RECEPTACLE
MA-141-005-261-A03WA

WIRE CONNECT CHART

- 1 — BLK
- 2 — BRN
- 3 — RED
- 4 — ORN
- 5 — YEL



Wire Codes

NEMA HP3-EXBEB (Formerly M16878/4-24 TFE 7 strand)

	6"	12"	18"	24"	30"	36"	42"	48"	54"	60"	66"	72"	84"	96"	108"	120"
MIL-STD-681*	WA	WB	WC	UD	UE	WD	UG	UH	UJ	UK	UL	UM	UN	UP	UQ	UR
WHITE	WE	WF	WG	VD	VE	WH	VG	VH	VJ	VK	VL	VM	VN	VP	VQ	VR
YELLOW	WJ	WK	WL			WM										

NEMA HP3-EXBDB (Formerly M16878/4-26 TFE 7 strand)

	6"	12"	18"	24"	30"	36"	42"	48"	54"	60"	66"	72"	84"	96"	108"	120"
MIL-STD-681*	WN	WP	WQ	YD	YE	WR	YG	YH	YJ	YK	YL	YM	YN	YP	YQ	YR
WHITE	WS	WT	WU	ZD	ZE	WV	ZG	ZH	ZJ	ZK	ZL	ZM	ZN	ZP	ZQ	ZR
YELLOW	WW	WX	WY			WZ										

NEMA HP3-EXBCB (Formerly M16878/4-28 TFE 7 strand)

	6"	12"	18"	24"	30"	36"	42"	48"	54"	60"	66"	72"	84"	96"	108"	120"
MIL-STD-681*	XA	XB	XC	1D	1E	XD	1G	1H	1J	1K	1L	1M	1N	1P	1Q	1R
WHITE	XE	XF	XG	2D	2E	XH	2G	2H	2J	2K	2L	2M	2N	2P	2Q	2R
YELLOW	XJ	XK	XL			XM										

TWISTED PAIR per NEMA WC27500-XXRC2U00 (SAE AS22759/11)

	6"	12"	18"	24"	30"	36"	42"	48"	54"	60"	66"	72"	84"	96"	108"	120"
24 AWG	AA	AB	AC	AD	AE	AF	AG	AH	AJ	AK	AL	AM	AN	AP	AQ	AR
26 AWG	BA	BB	BC	BD	BE	BF	BG	BH	BJ	BK	BL	BM	BN	BP	BQ	BR

TWISTED PAIR per NEMA WC27500-XXSC2U00 (SAE AS22759/33)*** ☒

	6"	12"	18"	24"	30"	36"	42"	48"	54"	60"	66"	72"	84"	96"	108"	120"
24 AWG	JA	JB	JC	JD	JE	JF	JG	JH	JJ	JK	JL	JM	JN	JP	JQ	JR
26 AWG	KA	KB	KC	KD	KE	KF	KG	KH	KJ	KK	KL	KM	KN	KP	KQ	KR

For twisted pair wire connect charts, see page MA-9
 Twisted pair wire not available on MA, MC or Hybrid connectors

* = Connectors with more than 100 contacts will repeat color code after 100 colors.

*** = Per M83513, corrosion has been experienced on connectors that are pre-wired with 22759/33 and stored in sealed environments.
 Caution should be exercised when using this wire.

☒ = Option not RoHS compliant

Wire Codes

SAE AS22759/11-24

	6"	12"	18"	24"	30"	36"	42"	48"	54"	60"	66"	72"	84"	96"	108"	120"
M83513**	5A	5B	5C	5D	5E	5F	5G	5H	5J	5K	5L	5M	5N	5P	5Q	5R
MIL-STD-681*	CA	CB	CC	CD	CE	CF	CG	CH	CJ	CK	CL	CM	CN	CP	CQ	CR
WHITE	DA	DB	DC	DD	DE	DF	DG	DH	DJ	DK	DL	DM	DN	DP	DQ	DR

SAE AS22759/11-26

	6"	12"	18"	24"	30"	36"	42"	48"	54"	60"	66"	72"	84"	96"	108"	120"
M83513**	6A	6B	V1	6D	6E	V2	6G	6H	6J	6K	6L	Y6	6N	6P	6Q	6R
MIL-STD-681*	X3	X4	W3	ED	EE	W4	EG	EH	EJ	EK	EL	EM	EN	EP	EQ	ER
WHITE	X1	X2	W1	FD	FE	W2	FG	FH	FJ	FK	FL	Y5	FN	FP	FQ	FR

SAE AS22759/33-24*** ☒

	6"	12"	18"	24"	30"	36"	42"	48"	54"	60"	66"	72"	84"	96"	108"	120"
M83513**	LA	LB	LC	LD	LE	LF	LG	LH	LJ	LK	LL	LM	LN	LP	LQ	LR
WHITE	MA	MB	MC	MD	ME	MF	MG	MH	MJ	MK	ML	MM	MN	MP	MQ	MR

SAE AS22759/33-26*** ☒

	6"	12"	18"	24"	30"	36"	42"	48"	54"	60"	66"	72"	84"	96"	108"	120"
M83513**	NA	NB	Y3	ND	NE	Y4	NG	NH	NJ	NK	NL	Y8	NN	NP	NQ	NR
WHITE	PA	PB	Y1	PD	PE	Y2	PG	PH	PJ	PK	PL	Y7	PN	PP	PQ	PR

* = Connectors with more than 100 contacts will repeat color code after 100 colors.

** = Wire colors per M83513 are ten solid colors repeating.

*** = Per M83513, corrosion has been experienced on connectors that are pre-wired with 22759/33 and stored in sealed environments.

Caution should be exercised when using this wire.

☒ = Option not RoHS compliant

1 • ROW Strip Connectors with Latches

.050"

MA-1

3 thru 60 Contacts

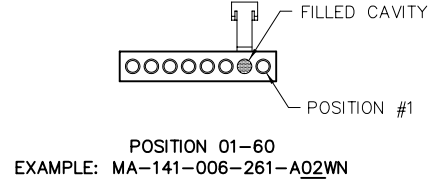
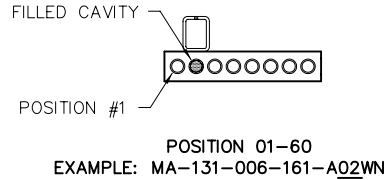
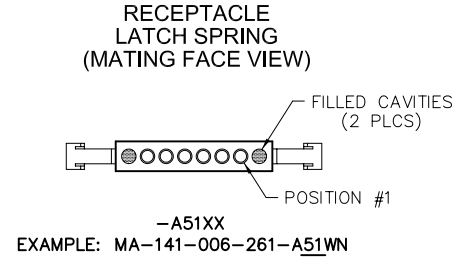
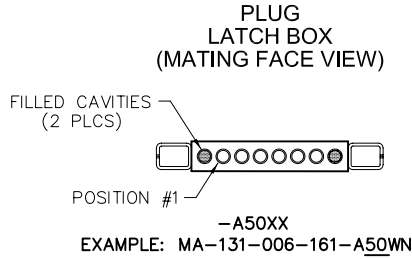

MA Strip Guidelines

For "A" designator in hardware portion of part number

1. Any cavity that has a contact is considered an electrical position (including dummy contact).
2. All hardware locations, holes and/or epoxy filled cavities are considered mechanical positions.
3. Omit holes on board layout for mechanical positions and renumber board layout accordingly, except connectors with mechanical position(s) in end cavity(ies).
See board layout examples, pages M-16 thru M-22.
4. These guidelines apply for all hardware options, including guide holes (mechanical locations).
5. Do not skip wire colors on stranded wire assemblies.
6. Spacers underneath the connector are recommended when R/A PCB mount connectors with mounting holes are used and the PCB had irregularities greater than .004" underneath the connector.

To determine hardware location number:

1. Divide the total number of cavities by two (including hardware cavity).
2. Round to the next whole number if result is a fraction.

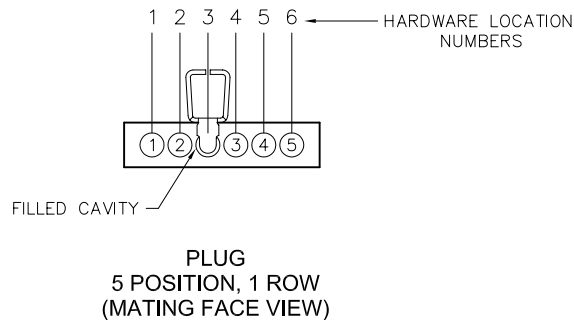

The connector above has 6 cavities with 5 live contacts.
(5 electrical positions & 1 mechanical position)

To determine the hardware location number:
6 cavities ÷ 2 = 3
Hardware would be placed in location #3

X-ON Electronics

Largest Supplier of Electrical and Electronic Components

Click to view similar products for [Rectangular MIL Spec Connectors](#) category:

Click to view products by [AirBorn](#) manufacturer:

Other Similar products are found below :

[M32139/03-B06ST](#) [65002-062](#) [CY4602-000](#) [77058-22-55PN](#) [86.030.0053.0](#) [GMCT26M0E100JC](#) [1241346-1](#) [MSO34MPK1E1](#)
[BACC65CAMA](#) [HSB-D4S03DM222X](#) [2217548-1](#) [890-009-31SA2-BRT1T](#) [27963-20T12](#) [SIM2N40NC3](#) [SIM2S100A](#) [1604996-2](#)
[SMD25PN90L-4055](#) [22628-10-6P-791](#) [GMCT66F0T0000](#) [M32139/03-G05SN](#) [CTD160E01F-6148](#) [CTJ112E03B](#) [CTJ122E02D-8000](#) [CTJ-](#)
[3D-12](#) [CTJ920E06N-513](#) [CTL-16-090](#) [CY4600-000](#) [CY4601-000](#) [38111-14-15SN](#) [38112-14-15PN](#) [TMN2N037PC2DM018S](#)
[TMN2N051SC2DM018T](#) [MMA23-0111R1](#) [MMD25-0071P1](#) [33516062020](#) [33526M11-08PE](#) [33526M11-08PN](#) [3355-5869-000](#) [DMC-M99-](#)
[01AN](#) [Y59113WE20PNV00300](#) [ZPF000000000106310](#) [105979-31](#) [MTCPK1PJC02S](#) [SIM2N40NC1](#) [SIM2N40NC2](#) [SIM2S110A](#)
[SIME2022PNR](#) [787-0015-02](#) [TMN2N009SC2DM018T](#) [TMN2N025PC2DM018S](#)