



# Right Angle Boardmount (Narrow Footprint)

.050"  
9 thru 100 Contacts

**MK, ML**

MK-252-031-335-220S (PLUG)

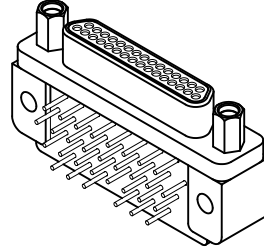

MK-262-031-445-220S (RCPT)

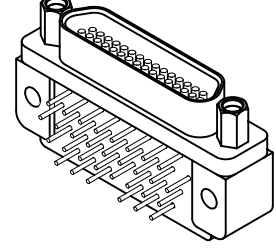

MATING MATRIX	
CONNECTOR	MATES WITH
MK-25...	MK, ML, MM, MN receptacles
ML-25...	MK, ML, MM, MN receptacles
MK-26..	MK, ML, MM, MN plugs
ML-26..	MK, ML, MM, MN plugs

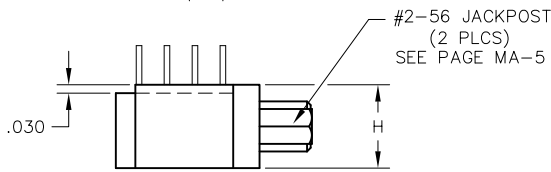
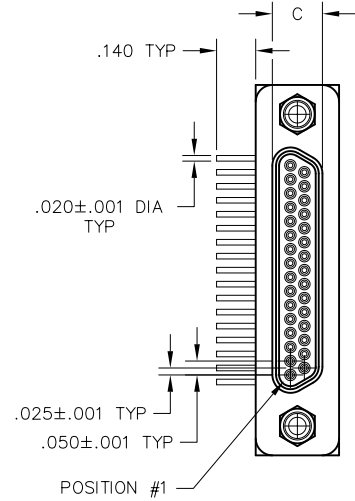
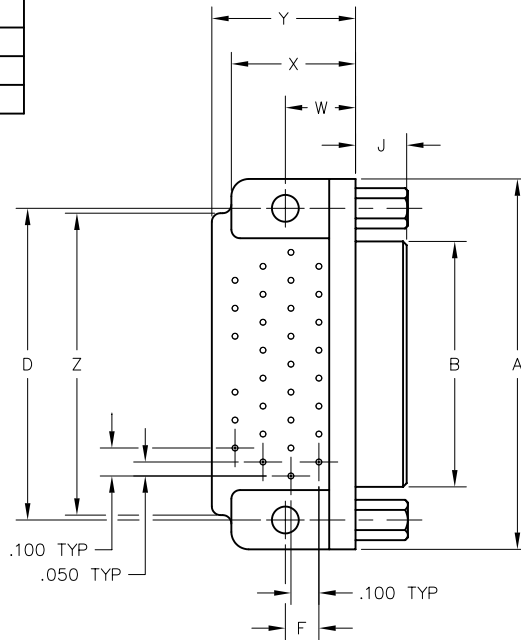

(PLUG SHOWN)

DIMENSIONS																			
SIZE	CONTACT ROWS	A	B		C		D	F	H	J		W	X MAX	Y MAX	Z	HARDWARE	MOUNTING HOLE		
			PLUG MAX	RCPT MAX	PLUG MAX	RCPT MAX				PLUG	RCPT								
9	2	.775	.334	.400	.185	.251	.565	.020	.298	.183	.195	.250	.420	.420	.775	#2-56 UNC THD	.096 DIA OR #2-56 UNC THREADED INSERT		
15		.925	.484	.550			.715											1.075	.925
21		1.075	.634	.700			.865											1.175	1.075
25		1.175	.734	.800			.965											1.325	1.175
31		1.325	.884	.950			1.115											1.475	1.325
37		1.475	1.034	1.100			1.265												1.180
51	3	1.425	.984	1.050	.228	.294	1.215	.150	.341	.300	.430	.650	1.220	.755	1.450	#4-40 UNC THD	.125 DIA #2-56 UNC INSERT #4-40 UNC INSERT		
69		1.725	1.284	1.350			1.515											1.450	
100		2.160	1.384	1.508			.271											.394	1.800

**PLUG:** MK-252-031-335-220S  
**RECEPTACLE:** MK-262-031-445-220S  
 XX-XXX-XXX-XXX-XXXX-XXX  
 |     |     |     |     |  
 BODY CONTACTS OPTIONS  
 SERIES SIZE HARDWARE

### PLUG

### RECEPTACLE

#### SERIES

MK .050" Rugged Metal PC Board Mount Connector  
 ML .050" Rugged Plastic PC Board Mount Connector  
 (MK & ML mate with MK, ML, MM, MN, receptacles)

#### BODY

- 2 2-Row (Sizes 9 thru 37)
  - 3 3-Row (Size 51 & 69\*\*\*)
  - 4 4-Row (Size 100)
- BODY STYLE:**
- 5 Plug, right angle, narrow footprint, w/ mounting holes
- BODY MATERIAL:**
- 1 Polyphenylene Sulfide (ML only)
  - 2 Electroless nickel shell w/ PPS insulator
  - 3 Electrodeposited cadmium shell w/ PPS insulator
  - 4 Hard anodized black shell w/ PPS insulator
  - 5 Stainless steel shell w/ PPS insulator

#### SIZE

XXX 009, 015, 021, 025, 031, 037, 051, 069\*\*\*, 100

#### CONTACTS

- TYPE CONTACTS/TERMINATIONS:**
- 32 Pin, right angle, PCB leads, .109"
  - 33 Pin, right angle, PCB leads, .140"
  - 34 Pin, right angle, PCB leads, .172"

- PLATING OPTIONS:**
- 3 50 μ" Au contacts: Au terminations
  - 5 50 μ" Au contacts: Sn/Pb alloy terminations
  - 7 50 μ" Au contacts: SAC305 terminations

#### HARDWARE

- STYLE OF HARDWARE:**
- 00 None
  - 22 Two fixed jacknuts (62\*)
  - 41 Two turning jackscrews, allen head, retaining ring\*\*\*\*(81\*)
  - 99 Keying hardware, see options below (Body material 2, 3 and 4 only)
- POLARIZATION / WIRING:**
- 0R Reversed body polarization
  - 0S Standard body polarization

#### OPTIONS

- KPXX Two fixed jacknuts (KN\*)
- 94P Mil-Spec footprint (size 100 only), standard body polarization
- 0B7 #2-56 threaded inserts, standard body polarization
- 0BJ Mil-Spec footprint (size 100 only) with #2-56 threaded inserts, standard body polarization
- 0H7 #4-40 threaded inserts (size 100 only), standard body polarization
- 0H6 Mil-Spec footprint (size 100 only) with #4-40 threaded inserts, standard body polarization

#### NOTES

See page MA-6 for keying options  
 \* = Use numbers in parenthesis when ordering size 100.  
 \*\*\* = 69 position connectors are available in metal only.  
 \*\*\*\* = Connector body has no mounting holes.  
 = Option not RoHS compliant

#### SERIES

MK .050" Rugged Metal PC Board Mount Connector  
 ML .050" Rugged Plastic PC Board Mount Connector  
 (MK & ML mate with MK, ML, MM, MN plugs)

#### BODY

- 2 2-Row (Sizes 9 thru 37)
  - 3 3-Row (Size 51 & 69\*\*\*)
  - 4 4-Row (Size 100)
- BODY STYLE:**
- 6 Receptacle, right angle, narrow footprint, w/ mounting holes
- BODY MATERIAL:**
- 1 Polyphenylene Sulfide (ML only)
  - 2 Electroless nickel shell w/ PPS insulator
  - 3 Electrodeposited cadmium shell w/ PPS insulator
  - 4 Hard anodized black shell w/ PPS insulator
  - 5 Stainless steel shell w/ PPS insulator

#### SIZE

XXX 009, 015, 021, 025, 031, 037, 051, 069\*\*\*, 100

#### CONTACTS

- TYPE CONTACTS/TERMINATIONS:**
- 43 Socket, right angle, PCB leads, .109"
  - 44 Socket, right angle, PCB leads, .140"
  - 45 Socket, right angle, PCB leads, .172"

- PLATING OPTIONS:**
- 3 50 μ" Au contacts: Au terminations
  - 5 50 μ" Au contacts: Sn/Pb alloy terminations
  - 7 50, u" Au contacts: SAC305 terminations

#### HARDWARE

- STYLE OF HARDWARE:**
- 00 None
  - 22 Two fixed jacknuts (62\*)
  - 41 Two turning jackscrews, allen head, retaining ring\*\*\*\*(81\*)
  - 99 Keying hardware, see options below (Body material 2, 3 and 4 only)
- POLARIZATION / WIRING:**
- 0R Reversed body polarization
  - 0S Standard body polarization

#### OPTIONS

- KPXX Two fixed jacknuts (KN\*) and interfacial sealing gasket.
- 900 Interfacial sealing gasket
- 0B7 #2-56 Threaded inserts and interfacial sealing gasket standard body polarization
- 0H7 #4-40 threaded inserts (size 100 only), and interfacial sealing gasket, standard body polarization

#### NOTES

See page MA-6 for keying options  
 \* = Use numbers in parenthesis when ordering size 100.  
 \*\*\* = 69 position connectors are available in metal only.  
 \*\*\*\* = Connector body has no mounting holes.  
 = Option not RoHS compliant



# Recommended PC Board Layout

Right Angle, Narrow Footprint  
Reverse Polarization



CONNECTOR MATING FACE

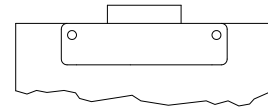

PC BOARD LAYOUT  
COMPONENT SIDE

PLUG  
PC BOARD LAYOUT  
COMPONENT SIDE

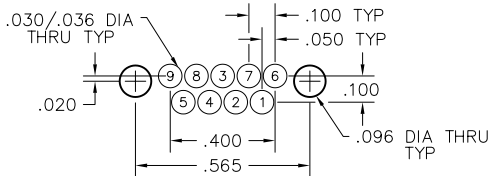

CONNECTOR  
MATING FACE\*  
(RECEPTACLE)



9 POSITION

RECEPTACLE  
PC BOARD LAYOUT  
COMPONENT SIDE

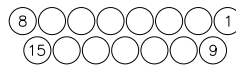
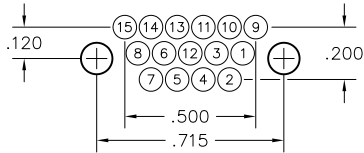
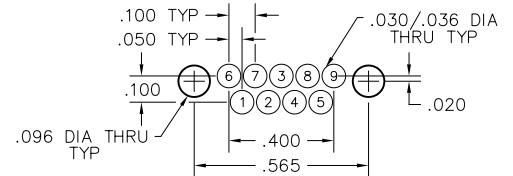

15 POSITION

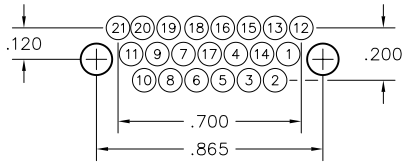
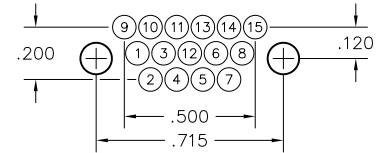

21 POSITION

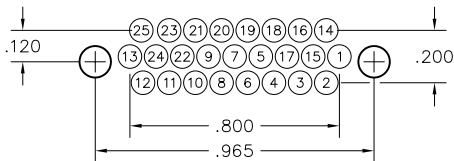
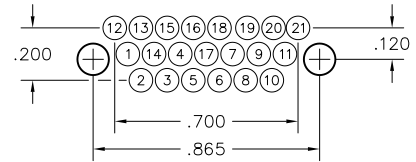

25 POSITION

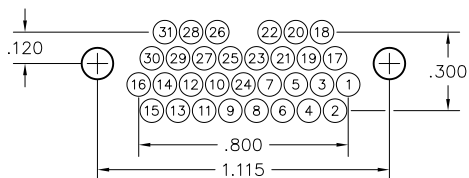
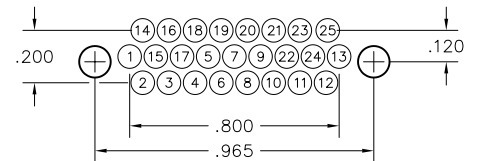

31 POSITION

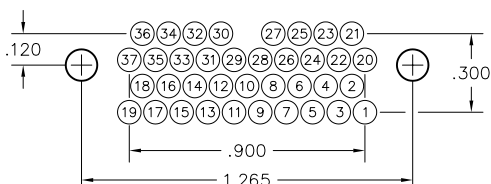
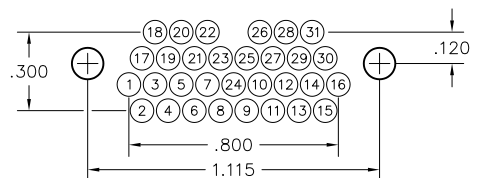

37 POSITION

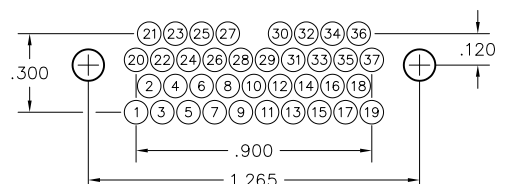

# Recommended PC Board Layout

Right Angle, Narrow Footprint  
Reverse Polarization

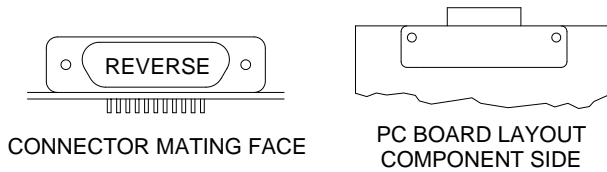

**PLUG**  
PC BOARD LAYOUT  
COMPONENT SIDE

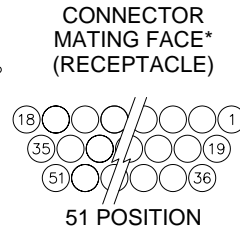
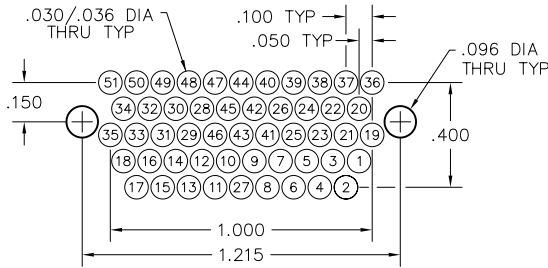

**RECEPTACLE**  
PC BOARD LAYOUT  
COMPONENT SIDE

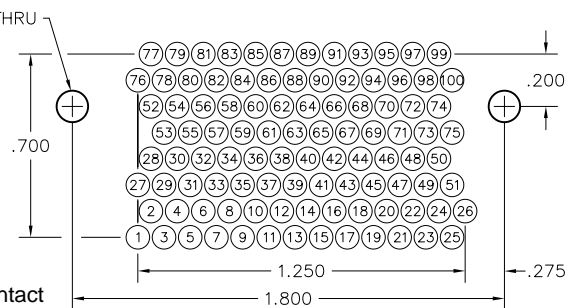
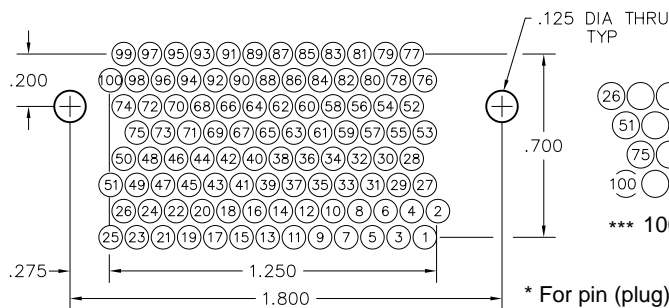
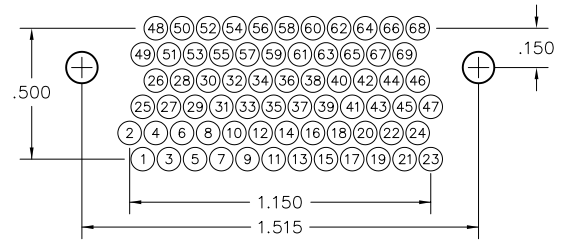
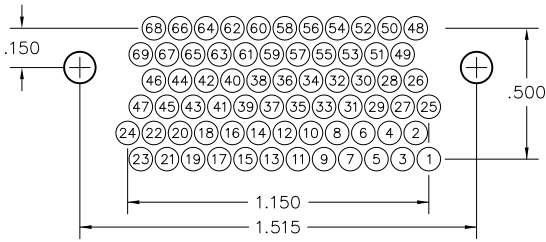
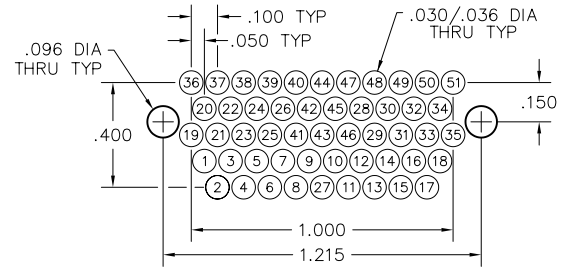

\* For pin (plug) connectors, the contact numbers are reversed left to right.

\*\* = 69 and 100 positions not available in low profile (MS, MR)

\*\*\* = 100 position not available in thru-cut body style (R, S)



# Recommended PC Board Layout

Right Angle, Narrow Footprint  
Standard Polarization



CONNECTOR MATING FACE

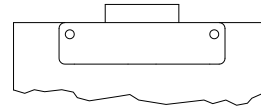

PC BOARD LAYOUT  
COMPONENT SIDE

**PLUG**  
PC BOARD LAYOUT  
COMPONENT SIDE

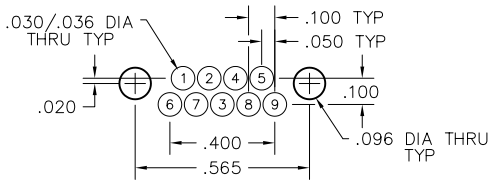

CONNECTOR  
MATING FACE\*  
(RECEPTACLE)

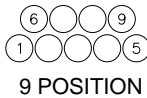

9 POSITION

**RECEPTACLE**  
PC BOARD LAYOUT  
COMPONENT SIDE

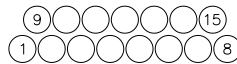
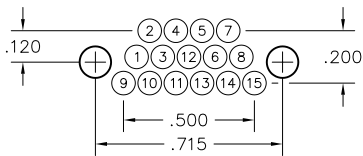
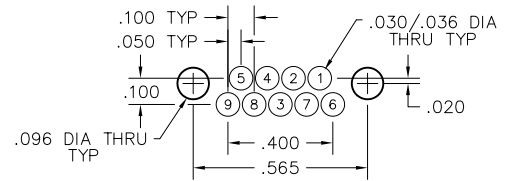

15 POSITION

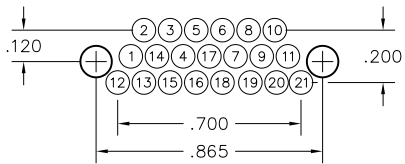
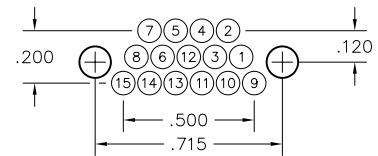

21 POSITION

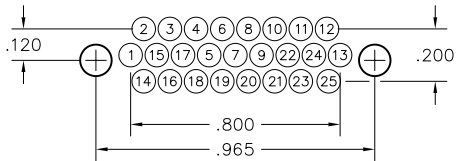
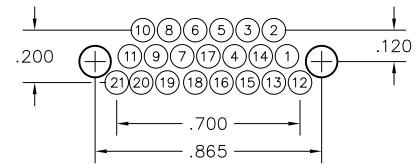

25 POSITION

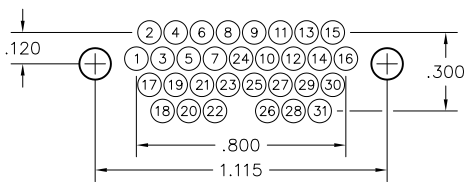
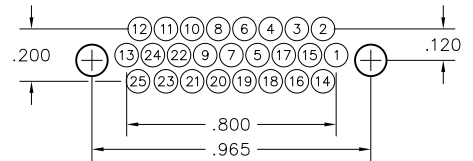

31 POSITION

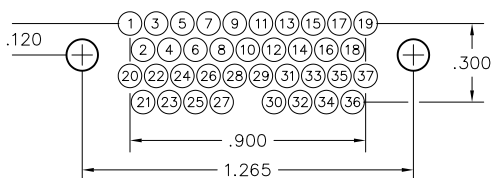
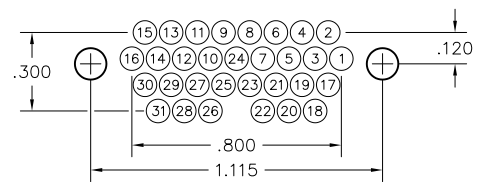

37 POSITION

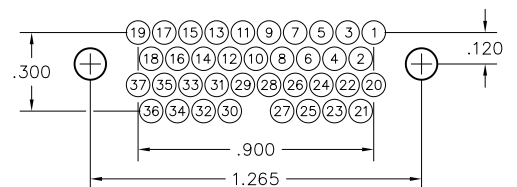

# Recommended PC Board Layout

Right Angle, Narrow Footprint  
Standard Polarization

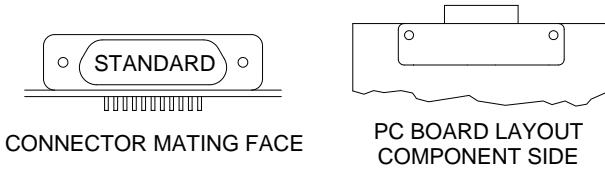

**PLUG**  
PC BOARD LAYOUT  
COMPONENT SIDE

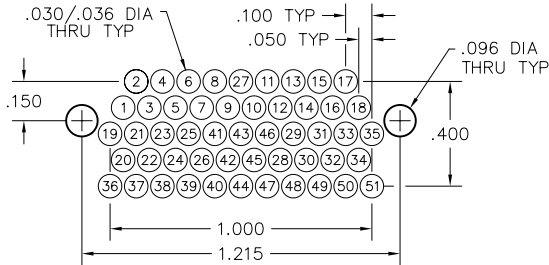

**CONNECTOR MATING FACE\* (RECEPTACLE)**

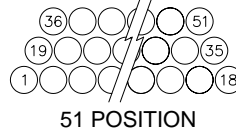

**RECEPTACLE**  
PC BOARD LAYOUT  
COMPONENT SIDE

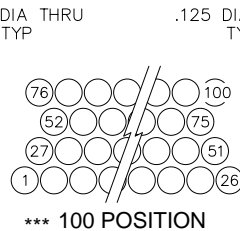
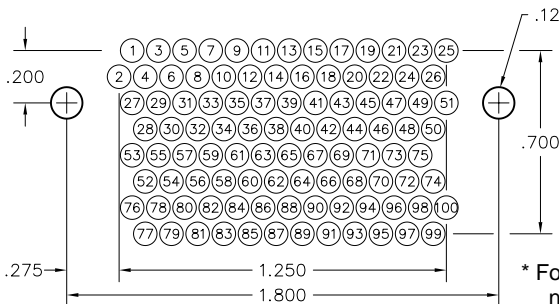
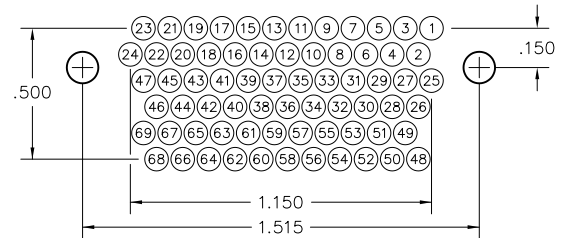
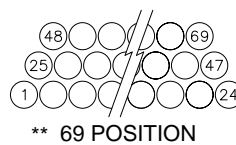
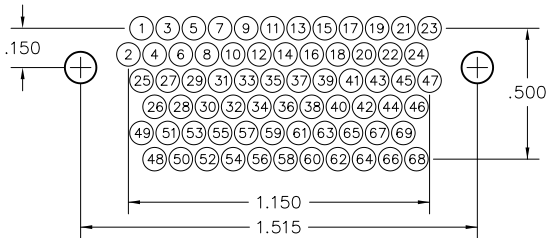
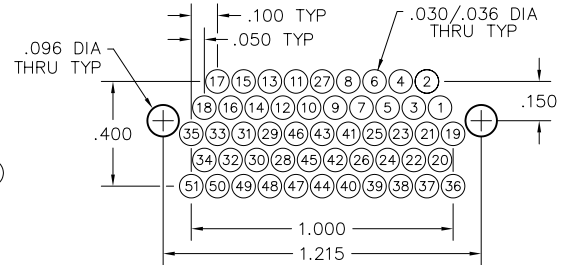

\* For pin (plug) connectors, the contact numbers are reversed left to right.

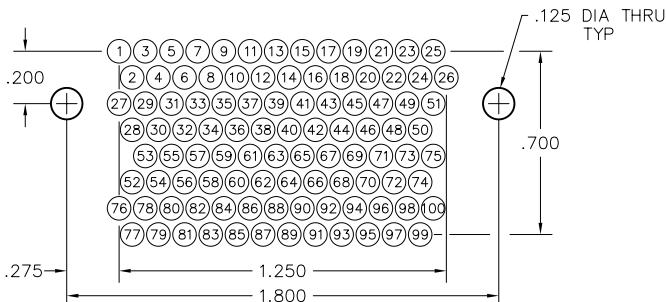
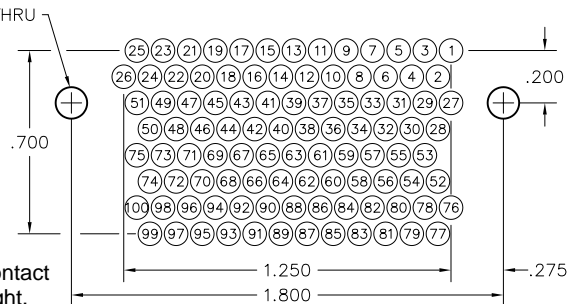

**Mil-Spec Footprint**

For Mil-Spec footprint, use "Option" -94P

- \*\* = 69 and 100 positions not available in low profile (MS, MR)
- \*\*\* = 100 position not available in thru-cut body style (R, S)

# Polarized Keying Hardware

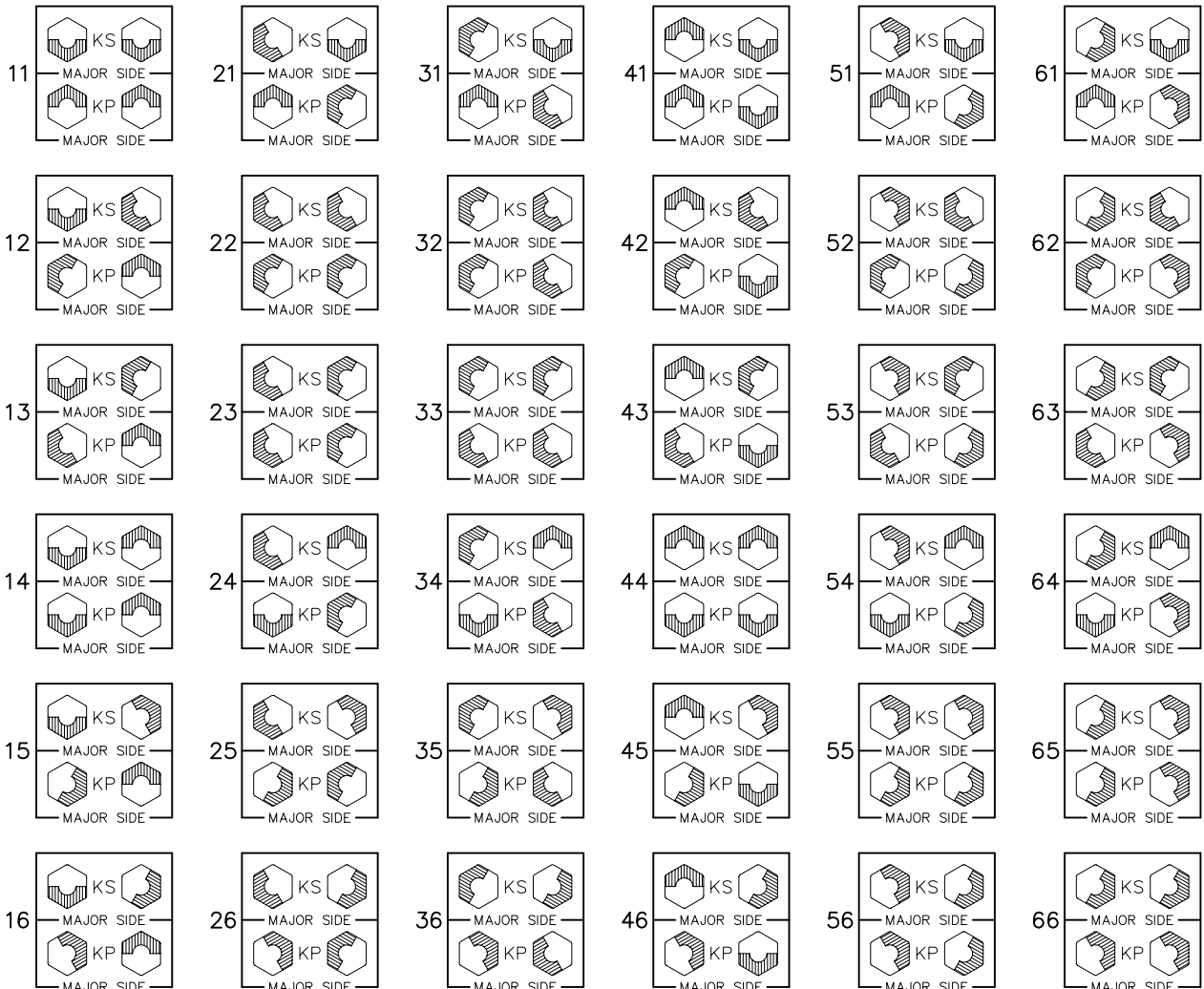

Select the appropriate two digit number above and include as the last two digits of the hardware code in the part number.  
(Keying hardware is factory installed and non-removable).

Example:

MM-213-025-161-99WA-KS11

MK-263-025-435-990S-KP11

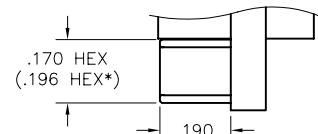
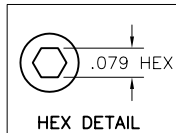
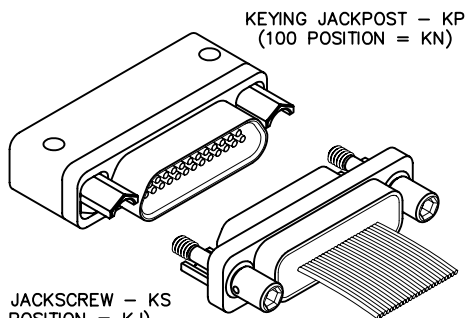

KEYING JACKPOST

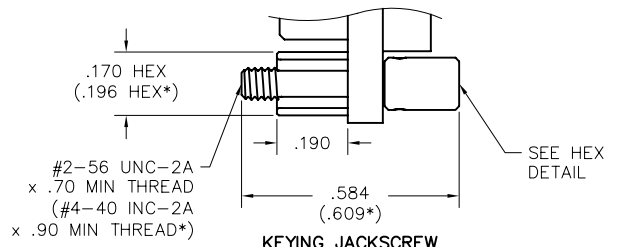

KEYING JACKSCREW

\* = Dimensions for 100 position connectors

## X-ON Electronics

Largest Supplier of Electrical and Electronic Components

*Click to view similar products for [D-Sub MIL Spec Connectors](#) category:*

*Click to view products by [AirBorn](#) manufacturer:*

Other Similar products are found below :

[M85049/50-5F](#) [MDM-15PH006M7-A174](#) [MDM-15SH001M7-A174](#) [MDM-15SH003M7-A174](#) [MDM-15SH006M7-A174](#) [MDM-21PH046F](#)  
[MDM-21SH006B-A174](#) [MDM-21SH006P-A174](#) [MDM-21SH011P](#) [MDM-21SH011P-A174](#) [MDM-21SH034B-A174](#) [MDM25SL61P](#) [850-](#)  
[056-0812](#) [1218697-4](#) [DA-59-20](#) [1484349-1](#) [17D25HV](#) [1996840-1](#) [243082-15](#) [308-CP3C1001-076](#) [1757682-1](#) [17D-E51218-1](#) [17SDA15S](#)  
[1883533-1](#) [1883889-1](#) [192900-0377](#) [308-CP6P0441-024H](#) [M83513/03-E09C](#) [443961-3](#) [MDM-15PH001F](#) [MDM-15PH001P-A174](#) [MDM-](#)  
[15PH011P](#) [MDM-15PH011P-A174](#) [MDM-15SH006M7](#) [MDM-15SH011F-A174](#) [MDM-15SH011P](#) [MDM-15SH011P-A174](#) [MDM-](#)  
[21PH006M7](#) [MDM-21PH041F](#) [MDM-21PH048F](#) [MDM-21SH003K-F222](#) [MDM-21SH046B-A174](#) [MDM-25PH001M7-A174](#) [MDM-](#)  
[25SH011P](#) [MDM-9SH001F](#) [MDM-9SH006P-A174](#) [5-1218949-1](#) [550-031NF1R6K](#) [3-1236089-2](#) [550E001NF1R3J0L](#)