

PC401

Compact, Surface Mount Type OPIC Photocoupler

■ Features

1. Mini-flat package
2. "High" output during light emission
3. Isolation voltage between input and output
($V_{iso} : 3\,750V_{rms}$)
4. TTL and LSTTL compatible output
5. Recognized by UL(No.64380)

■ Applications

1. Hybrid substrate which requires high density mounting
2. Personal computers, office computers and peripheral equipment
3. Electronic musical instruments

■ Package Specifications

Model No.	Package specifications	Diameter of reel	Tape width
PC401	Taping package (Net : 3 000pcs.)	370mm	12mm
PC401T	Taping package (Net : 750pcs.)	178mm	12mm
PC401Z	Sleeve package (Net : 100pcs.)	-	-

■ Absolute Maximum Ratings

($T_a = 25^\circ C$)

Parameter		Symbol	Rating	Unit
Input	Forward current	I_F	50	mA
	Reverse voltage	V_R	6	V
	Power dissipation	P	70	mW
Output	Supply voltage	V_{CC}	16	V
	High level output voltage	V_{OH}	16	V
	Low level output current	I_{OL}	50	mA
	Power dissipation	P_O	130	mW
Total power dissipation		P_{tot}	150	mW
*1	Isolation voltage	V_{iso}	3 750	V_{rms}
Operating temperature		T_{opr}	- 25 to + 85	$^\circ C$
Storage temperature		T_{stg}	- 40 to + 125	$^\circ C$
*2	Soldering temperature	T_{sol}	260	$^\circ C$

*1 AC for 1 minute, 40 to 60% RH

*2 For 10 seconds

■ Outline Dimensions

(Unit : mm)

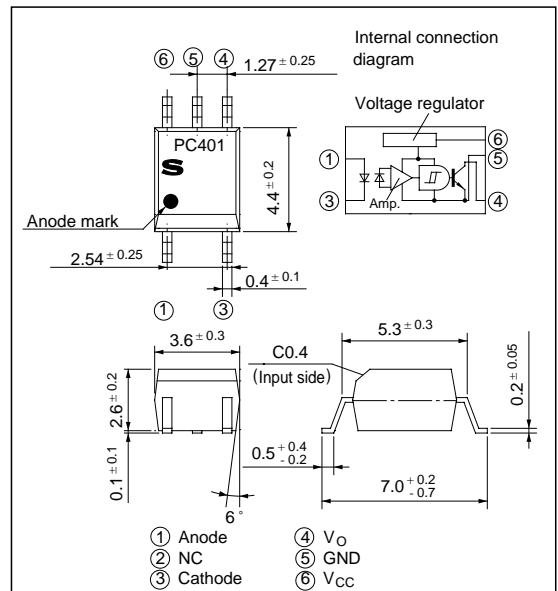

* "OPIC" (Optical IC) is a trademark of the SHARP Corporation.

An OPIC consists of a light-detecting element and signal-processing circuit integrated onto a single chip.

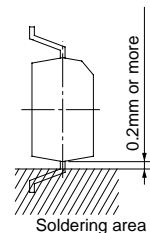

Electro-optical Characteristics

($T_a = 0$ to $+70^\circ\text{C}$ unless otherwise specified.)

Parameter		Symbol	Conditions	MIN.	TYP.	MAX.	Unit	
Input	Forward voltage	V_F	$I_F = 4\text{mA}$	-	1.1	1.4	V	
			$I_F = 0.3\text{mA}$	0.7	1.0	-		
	Reverse current	I_R	$T_a = 25^\circ\text{C}, V_R = 3\text{V}$	-	-	10	μA	
	Terminal capacitance	C_t	$T_a = 25^\circ\text{C}, V = 0, f = 1\text{kHz}$	-	30	250	pF	
Output	Operating supply voltage	V_{CC}		3	-	15	V	
	Low level output voltage	V_{OL}	$I_F = 0, V_{CC} = 5\text{V}, I_{OL} = 16\text{mA}$	-	0.2	0.4	V	
	High level output current	I_{OH}	$I_F = 4\text{mA}, V_{CC} = V_O = 15\text{V}$	-	-	100	μA	
	Low level supply current	I_{CCL}	$I_F = 0, V_{CC} = 5\text{V}$	-	2.5	5.0	mA	
	High level supply current	I_{CCH}	$I_F = 4\text{mA}, V_{CC} = 5\text{V}$	-	2.7	5.5	mA	
Transfer characteristics	*3 "H \rightarrow L" threshold input current	I_{FHL}	$T_a = 25^\circ\text{C}, V_{CC} = 5\text{V}, R_L = 280\Omega$	0.4	0.8	-	mA	
			$V_{CC} = 5\text{V}, R_L = 280\Omega$	0.3	-	-		
	*4 "L \rightarrow H" threshold input current	I_{FLH}	$T_a = 25^\circ\text{C}, V_{CC} = 5\text{V}, R_L = 280\Omega$	-	1.1	2.0	mA	
			$V_{CC} = 5\text{V}, R_L = 280\Omega$	-	-	4.0		
	*5 Hysteresis		I_{FHL} / I_{FLH}	$V_{CC} = 5\text{V}, R_L = 280\Omega$	0.5	0.7	0.9	
	Isolation resistance		R_{ISO}	$T_a = 25^\circ\text{C}, \text{DC} 500\text{V}, 40$ to 60% RH	5×10^{10}	10^{11}	-	Ω
*6 Response time	"H \rightarrow L" propagation delay time	t_{PHL}	$T_a = 25^\circ\text{C}, V_{CC} = 5\text{V}$ $R_L = 280\Omega, I_F = 4\text{mA}$	-	2	6	μs	
	"L \rightarrow H" propagation delay time	t_{PLH}		-	1	3		
	Fall time	t_f		-	0.05	0.5		
	Rise time	t_r		-	0.1	0.5		

*3 I_{FHL} represents forward current when output goes from high to low.

*4 I_{FLH} represents forward current when output goes from low to high.

*5 Hysteresis stands for I_{FHL} / I_{FLH} .

*6 Test circuit for response time is shown below.

Test Circuit for Response Time

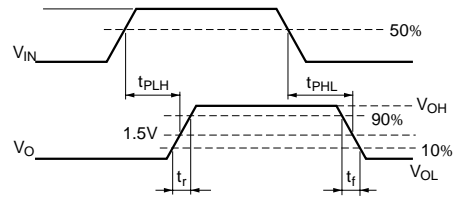
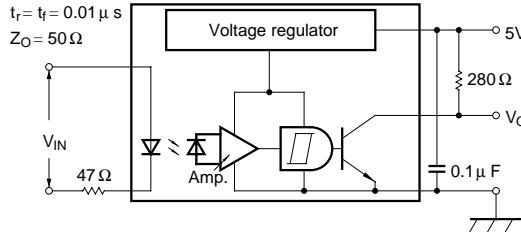

Fig. 1 Forward Current vs. Ambient Temperature

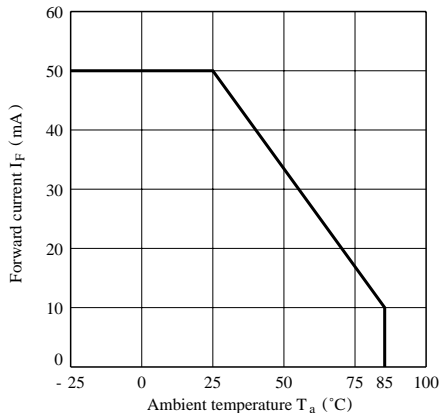

Fig. 2 Power Dissipation vs. Ambient Temperature

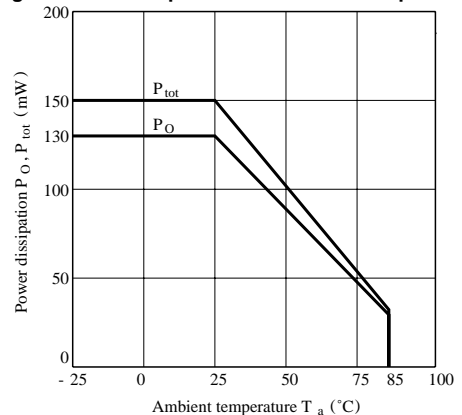

Fig. 3 Forward Current vs. Forward Voltage

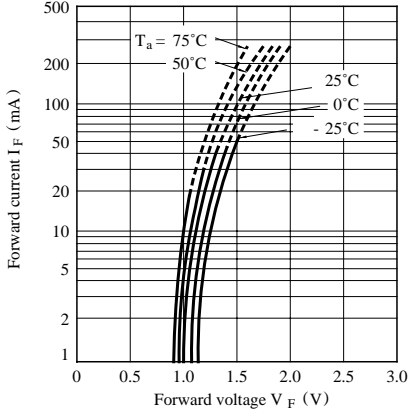

Fig. 4 Relative Threshold Input Current vs. Supply Voltage

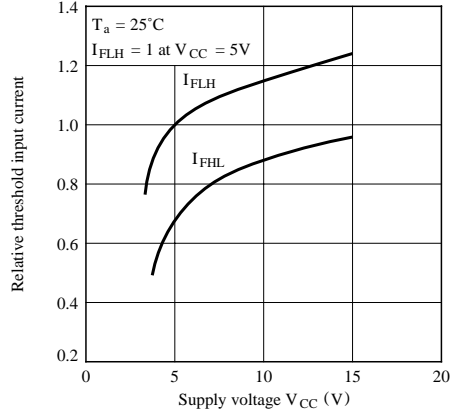

Fig. 5 Relative Threshold Input Current vs. Ambient Temperature

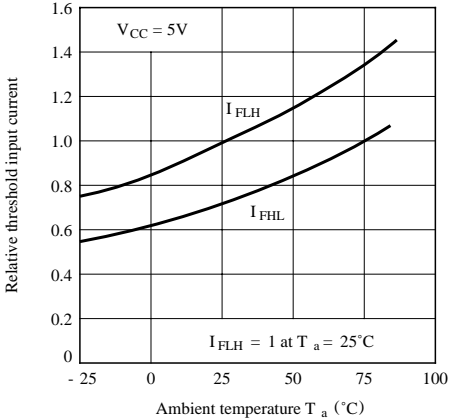

Fig. 6 Low Level Output Voltage vs. Low Level Output Current

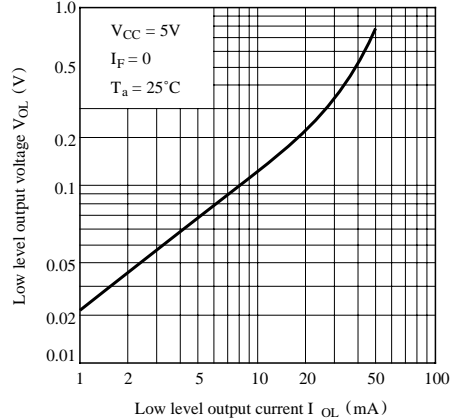

Fig. 7 Low Level Output Voltage vs. Ambient Temperature

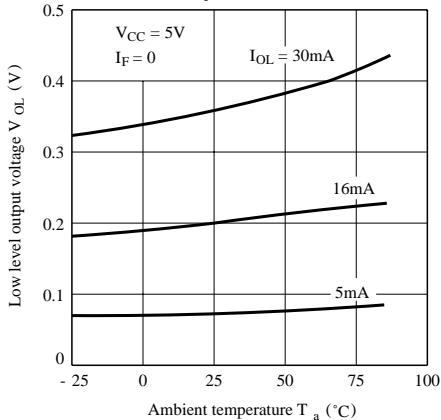

Fig. 8 High Level Output Current vs. Forward Current

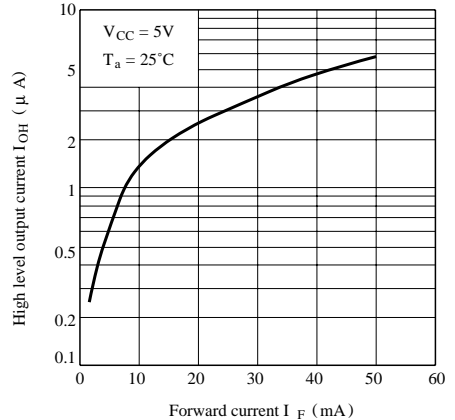

Fig. 9 High Level Output Current vs. Ambient Temperature

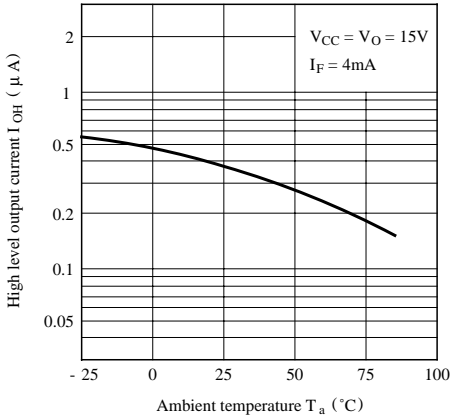

Fig.10 Supply Current vs. Supply Voltage

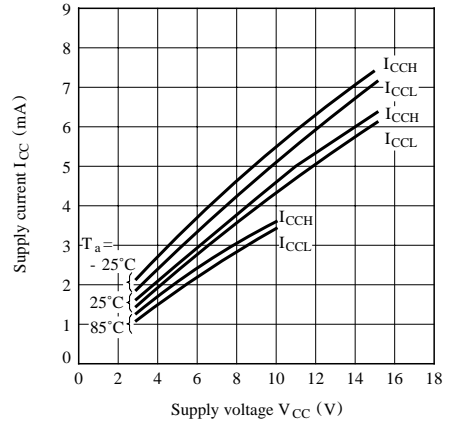

Fig.11 Propagation Delay Time vs. Forward Current

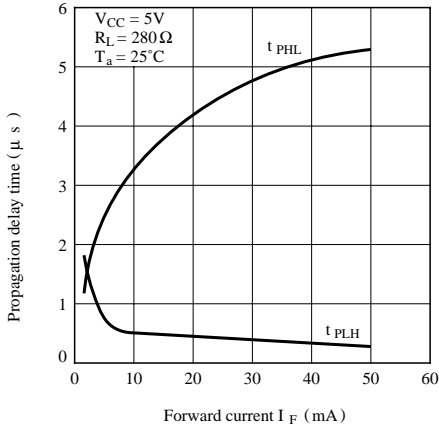
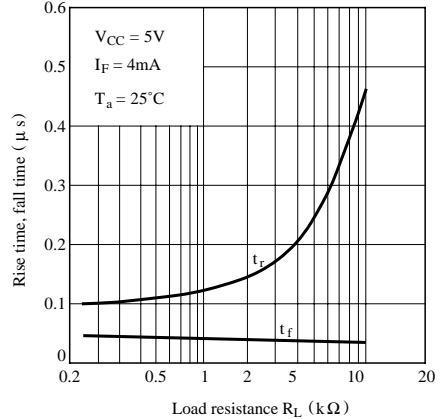

Fig.12 Rise Time, Fall Time vs. Load Resistance



■ Preautions for Use

- (1) It is recommended that a by-pass capacitor of more than $0.01\mu F$ is added between V_{cc} and GND near the device in order to stabilize power supply line.
- (2) Handle this product the same as with other integrated circuits against static electricity.
- (3) As for other general cautions, refer to the chapter "Precautions for Use"

NOTICE

- The circuit application examples in this publication are provided to explain representative applications of SHARP devices and are not intended to guarantee any circuit design or license any intellectual property rights. SHARP takes no responsibility for any problems related to any intellectual property right of a third party resulting from the use of SHARP's devices.
- Contact SHARP in order to obtain the latest device specification sheets before using any SHARP device. SHARP reserves the right to make changes in the specifications, characteristics, data, materials, structure, and other contents described herein at any time without notice in order to improve design or reliability. Manufacturing locations are also subject to change without notice.
- Observe the following points when using any devices in this publication. SHARP takes no responsibility for damage caused by improper use of the devices which does not meet the conditions and absolute maximum ratings to be used specified in the relevant specification sheet nor meet the following conditions:
 - (i) The devices in this publication are designed for use in general electronic equipment designs such as:
 - Personal computers
 - Office automation equipment
 - Telecommunication equipment [terminal]
 - Test and measurement equipment
 - Industrial control
 - Audio visual equipment
 - Consumer electronics
 - (ii) Measures such as fail-safe function and redundant design should be taken to ensure reliability and safety when SHARP devices are used for or in connection with equipment that requires higher reliability such as:
 - Transportation control and safety equipment (i.e., aircraft, trains, automobiles, etc.)
 - Traffic signals
 - Gas leakage sensor breakers
 - Alarm equipment
 - Various safety devices, etc.
 - (iii) SHARP devices shall not be used for or in connection with equipment that requires an extremely high level of reliability and safety such as:
 - Space applications
 - Telecommunication equipment [trunk lines]
 - Nuclear power control equipment
 - Medical and other life support equipment (e.g., scuba).
- Contact a SHARP representative in advance when intending to use SHARP devices for any "specific" applications other than those recommended by SHARP or when it is unclear which category mentioned above controls the intended use.
- If the SHARP devices listed in this publication fall within the scope of strategic products described in the Foreign Exchange and Foreign Trade Control Law of Japan, it is necessary to obtain approval to export such SHARP devices.
- This publication is the proprietary product of SHARP and is copyrighted, with all rights reserved. Under the copyright laws, no part of this publication may be reproduced or transmitted in any form or by any means, electronic or mechanical, for any purpose, in whole or in part, without the express written permission of SHARP. Express written permission is also required before any use of this publication may be made by a third party.
- Contact and consult with a SHARP representative if there are any questions about the contents of this publication.

X-ON Electronics

Largest Supplier of Electrical and Electronic Components

Click to view similar products for [Other Tools](#) category:

Click to view products by [AIRTAC](#) manufacturer:

Other Similar products are found below :

[899-2-KT46](#) [CR-0AFL4--332K](#) [568681-1](#) [5800-0090](#) [58061-1](#) [59085](#) [00-8273-RDPP](#) [593033](#) [593072](#) [593564100](#) [593575](#) [593593](#) [010-0003-0000](#) [011349-000](#) [CRCW08052740FRT1](#) [LUC-012S070DSM](#) [LUC-018S070DSP](#) [LUC-024S105DSP](#) [599-2021-3-NME](#) [599-JJ-2021-03](#) [CRCW2010331JR02](#) [601-JJ-06](#) [601-SPB](#) [601YSY](#) [602-JJ-03](#) [602SPB](#) [603-JJ-07-FP](#) [603-JJY-04](#) [CRTN1013](#) [CS16](#) [6-1579014-0](#) [62036240-1](#) [M43435 TY 1 SZ 3 FIN B BLK](#) [M43435 TY 2 SZ 3 FIN C BLK](#) [M43435 TY 5 SZ 3 FIN C NAT](#) [M-5Z](#) [M6816](#) [660-29ABT1](#) [662508-1](#) [CVHD-950X-93.333](#) [CW104-01X](#) [671-GP-04-KT39-73207](#) [CW307-01A](#) [CW30901A](#) [CW6211201A](#) [679793-1](#) [690191-1](#) [690191-3](#) [690317-2](#)