

Part Numbering System



① Category code

Type	Code
	1
Electrolytic Capacitor	E
Conductive Polymer	S

② Series code

Series name	Code	
	2	3
WH	W	H
CD11GE	G	E
CD11GES	G	X
CD11GAS	G	W
CD11GHS	G	S
NR	N	R
PZ	P	Z

③ Voltage code

WV (V _{dc})	Code	
	4	5
2.5	0	E
3	0	D
4	0	G
6.3	0	J
6.8	0	C
7	0	Q
7.5	0	A
10	1	A
12	1	T
16	1	C
25	1	E
35	1	V
40	1	G
50	1	H
63	1	J
80	1	B
100	1	K
120	2	B
160	2	C
180	2	L
200	2	D
220	2	N
250	2	E
315	2	F
350	2	V
380	2	P
400	2	G
420	2	T
450	2	W
500	2	H
550	2	J
600	2	K

④ Capacitance tolerance code

Tol. (%)	Code
	6
-10~+10	K
-20~+20	M
-10~+30	Q
-10~+20	V
0~+20	A
-5~+20	C
-10~-20	B
-5~+5	D
0~+10	E
-5~-20	F
-15~+5	N

⑤ Capacitance code

Cap (μF)	Code		
	7	8	9
0.10	R	1	0
0.22	R	2	2
0.33	R	3	3
0.47	R	4	7
0.68	R	6	8
1	0	1	0
2.2	2	R	2
3.3	3	R	3
4.7	4	R	7
6.8	6	R	8
10	1	0	0
22	2	2	0
33	3	3	0
47	4	7	0
68	6	8	0
100	1	0	1
220	2	2	1
330	3	3	1
470	4	7	1
680	6	8	1
1000	1	0	2
2200	2	2	2
3300	3	3	2
4700	4	7	2
6800	6	8	2
10000	1	0	3
22000	2	2	3
33000	3	3	3
68000	6	8	3

⑥ Size code

ΦD (mm)	Code
10	
4	C
5	D
6.3	E
8	F
10	G
11	H
12	J
12.5	W
13	K
14	X
16	L
18	M
19	Z
20	N
22	O
25	P
30	Q
35	R
40	Y
51.6	S
64.3	T
76.9	U
91	V
100	A

L (mm)	Code	
	11	12
5	0	5
7	0	7
11	1	1
12	1	2
16	1	6
20	2	0
25	2	5
30	3	0
35	3	5
40	4	0
46	4	6
50	5	0
60	6	0
80	8	0
100	A	0
115	B	5
120	C	0
130	D	0
140	E	0
160	G	0
200	K	0
220	M	0
236	N	6
250	P	0

⑦ Terminal code

Specification	Code	Size	
	13	14	15
Bulk packing	O	-	-
Taping (SMD Type)	D	0	0
Φ4~8 Taping F=5.0mm	P	5	0
Φ10~12.5 Taping F=5.0mm	B	5	0
Lead Cut L=3.5mm	C	3	5
Lead Cut L=11.0mm	C	B	0
Lead Forming & Cut L=4.5mm	F	-	-
Kink & Cut L=4.5mm	J	-	-
Snap-in type Terminal 4.0mm in length	K	-	-
Three Terminals	T	-	-
Ring clip mounting standard design	A	0	0
Ring clip mounting special design	S	-	-

⑧ Sleeve/Marking code

Sleeve/Marking	Code
	16
PVC	C
PET	T
Dark blue	B
Bright red	R
Sky-blue	S
Light blue	T
Pink	Z
Black	H
Purple-blue	V
Red	O

Lead Forming
Taping Specifications

Fig.1 code: X



Fig.2 code: B



Fig.3 code: B



Fig.4 code: P

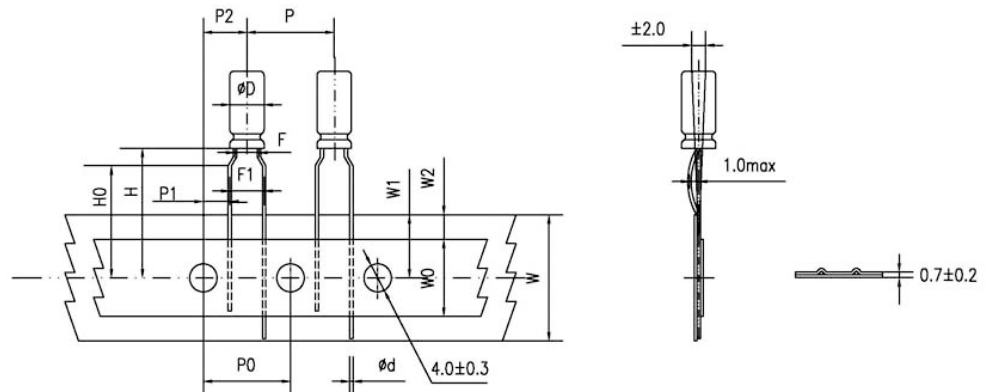

Lead Forming

Specification Fig.1 & Fig.2 & Fig.3

Items	Symbol	Case size										Tolerance		
		4*5 4*7		5*5 5*7		5*11		6.3*5	6.3*7 6.3*9	6.3*11 6.3*12	8*5/7 8*9/11 8*11.5 8*12		8*16 8*20	10*9/12 10*12.5 10*13/16 10*20/25
Pin Code		X	B	X	B	X	B	B	B	B	B	B	B	
Lead wire diameter	Φd	0.45		0.45		0.5		0.45	0.5	0.5	0.45/0.5	0.6	0.6	±0.05
Pitch of body	P	12.7		12.7		12.7		12.7	12.7	12.7	12.7	12.7	12.7	±1.0
Feed hole pitch	P0	12.7		12.7		12.7		12.7	12.7	12.7	12.7	12.7	12.7	±0.2
Distance from hole center to lead	P1	5.1	5.6	5.1	5.35	5.1	5.35	5.1	5.1	5.1	4.6	4.6	3.85	±0.7
Distance from feed hole center to body center	P2	6.35		6.35		6.35		6.35	6.35	6.35	6.35	6.35	6.35	±1.0
Lead-to-lead distance	F	2.5	1.5	2.5	2.0	2.5	2.0	2.5	2.5	2.5	3.5	3.5	5.0	±0.5
Height of body from tape center	H	18.5		18.5		18.5		18.5	18.5	18.5	18.5	18.5	18.5	±0.75
Base tape width	W	18.0		18.0		18.0		18.0	18.0	18.0	18.0	18.0	18.0	±0.5
Adhesive tape width	W0	6.0		6.0		6.0		6.0	6.0	8.0	8.0	8.0	11.0	min
Hole position	W1	9.0		9.0		9.0		9.0	9.0	9.0	9.0	9.0	9.0	+0.75 -0.5
Hole down tape position	W2	3.0		3.0		3.0		3.0	3.0	3.0	3.0	3.0	3.0	max

Specification Fig.4

Items	Symbol	Case size									Tolerance
		4*5 4*7	5*5	5*7	5*11	6.3*5	6.3*7 6.3*9	6.3*11 6.3*12	8*5/7 8*9/11 8*11.5/12	8*16 8*20	
Pin Code		P	P	P	P	P	P	P	P	P	
Lead wire diameter	Φd	0.45	0.45	0.45	0.5	0.45	0.5	0.5	0.45/0.5	0.6	±0.05
Pitch of body	P	12.7	12.7	12.7	12.7	12.7	12.7	12.7	12.7	12.7	±1.0
Feed hole pitch	P0	12.7	12.7	12.7	12.7	12.7	12.7	12.7	12.7	12.7	±0.2
Distance from hole center to lead	P1	3.85	3.85	3.85	3.85	3.85	3.85	3.85	3.85	3.85	±0.7
Distance from feed hole center to body center	P2	6.35	6.35	6.35	6.35	6.35	6.35	6.35	6.35	6.35	±1.0
Lead-to-lead distance	F	1.5	2.0	2.0	2.0	2.5	2.5	2.5	3.5	3.5	±0.5
Lead to lead distance	F1	5.0	5.0	5.0	5.0	5.0	5.0	5.0	5.0	5.0	+0.8 -0.2
Height of body from tape center	H	18.5	18.5	18.5	18.5	18.5	18.5	18.5	18.5	18.5	±0.75
Lead wire clinch height	H0	16.0	16.0	16.0	16.0	16.0	16.0	16.0	16.0	16.0	±0.5
Base tape width	W	18.0	18.0	18.0	18.0	18.0	18.0	18.0	18.0	18.0	±0.5
Adhesive tape width	W0	6.0	6.0	6.0	6.0	6.0	6.0	8.0	8.0	8.0	min
Hole position	W1	9.0	9.0	9.0	9.0	9.0	9.0	9.0	9.0	9.0	+0.75 -0.5
Hole down tape position	W2	3.0	3.0	3.0	3.0	3.0	3.0	3.0	3.0	3.0	max

Lead Forming

Lead Forming & Cut

Code:C
RANGE: $\Phi 4\sim\Phi 18$



Code:F
RANGE: $\Phi 4\sim\Phi 8$



ΦD	F	L	ΦD	F	L
4	1.5	3.0~12.0	4	5.0	3.5, 4.5, 5.0, 7.0
5	2.0	3.0~12.0	5	5.0	3.5, 4.5, 5.0, 7.0
6.3	2.5	3.0~12.0	6.3	5.0	3.5, 4.5, 5.0, 7.0
8	3.5	3.0~12.0	8	5.0	3.5, 4.5, 5.0, 7.0
10	5.0	3.0~12.0	-	-	-
12.5	5.0	3.0~12.0	-	-	-
16	7.5	3.0~12.0	-	-	-
18	7.5	3.0~12.0	-	-	-

Code:J
RANGE: $\Phi 10\sim\Phi 18$



ΦD	F	L
10	5.0	4.0, 4.5, 5.0
12.5	5.0	4.0, 4.5, 5.0
16	7.5	4.0, 4.5, 5.0
18	7.5	4.0, 4.5, 5.0

CD11GHS series

Upgrade

- Upgrade for CD11GH Series, longer life, better performance, cost-effective
- Endurance: +105°C 6,000 hours
- Suitable for electronic ballast and electronic energy saving lamp.
- **RoHS Compliant**

CD11GH



CD11GHS



SPECIFICATIONS

Items	Characteristics							
Category Temperature Range	-40~+105°C(160~450 V _{dc})							
Rated Voltage Range	160~450 V _{dc}							
Capacitance Tolerance	±20%(M) (at 20°C,120Hz)							
Leakage Current	160~400 V _{dc}	450 V _{dc}		Where, I: Max.leakage current (μA),C:Nominal capacitance (μF), V: Rated voltage (V)				(at 20°C after 2 minutes)
	I≤0.02CV+10μA	I≤0.03CV+10μA						
Dissipation Factor (tanδ)	Rated Voltage(V _{dc})	160	200	250	350	400	450	(at 20°C,120Hz)
	tanδ (max.)	0.15	0.15	0.15	0.20	0.20	0.20	
Low Temperature Characteristics (Max. Impedance Ratio)	Rated Voltage(V _{dc})	160	200	250	350	400	450	(at 120Hz)
	Z(-25°C)/Z(+20°C)	3	3	3	5	5	6	
	Z(-40°C)/Z(+20°C)	6	6	6	6	6	9	
Endurance	The specifications listed below shall be met when the capacitors are restored to 20°C after DC voltage plus rated ripple current is applied for 6,000 hours at 105°C, the peak voltage shall not exceed the rated voltage.							
	Capacitance Change	≤±20% of the initial value						
	D.F. (tanδ)	≤200% of the initial specified value						
	Leakage Current	≤The initial specified value						
Shelf Life	The following specifications shall be satisfied when the capacitors are restored to 20°C after leaving them under no load at 105°C for 1,000 hours.							
	Capacitance Change	≤±20% of the initial value						
	D.F. (tanδ)	≤200% of the initial specified value						
	Leakage Current	≤200% of the initial specified value						

DIMENSIONS[mm]

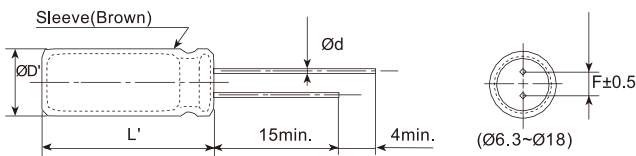

ØD	6.3	8	10	12.5	16	18
Ød	0.5	0.5	0.6	0.6	0.8	0.8
F	2.5	3.5	5.0	5.0	7.5	7.5
ØD'	ØD+0.5max.					
L'	L+2max.					

PART NUMBERING SYSTEM

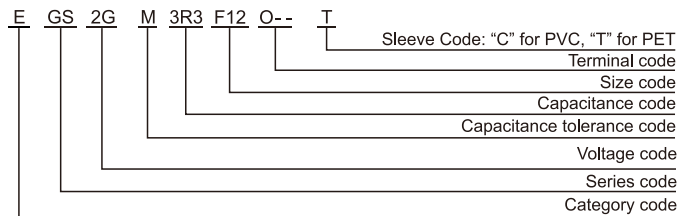

RATED RIPPLE CURRENT MULTIPLIERS

Frequency correction factor for ripple current

	Freq.(Hz)	120	1k	10k	100k
Rated voltage(V _{dc})		0.50	0.80	0.90	1.00
160~450					

CD11GHS series

■ STANDARD RATINGS

WV (V _{dc})	Cap (μF)	Size ΦDxL(mm)	tanδ	Rated ripple current (mArms/105°C,100kHz)
160(2C)	1	6.3*9	0.15	36
		6.3*12	0.15	40
	1.5	6.3*12	0.15	50
		6.3*9	0.15	50
	1.8	6.3*12	0.15	56
		6.3*9	0.15	56
	2.2	6.3*12	0.15	60
		6.3*9	0.15	62
	2.8	6.3*12	0.15	68
		6.3*9	0.15	67
	3.3	6.3*12	0.15	72
		6.3*12	0.15	75
	4.7	8*12	0.15	80
		6.3*12	0.15	79
	5.6	8*12	0.15	84
		8*9	0.15	89
	6.8	8*12	0.15	96
		8*9	0.15	105
	8.2	8*12	0.15	110
		8*9	0.15	165
	10	8*12	0.15	206
		8*12	0.15	230
	15	8*16	0.15	250
		8*16	0.15	340
	22	8*20	0.15	400
		10*16	0.15	420
	33	10*20	0.15	450
		10*16	0.15	460
47	10*20	0.15	500	
	12.5*16	0.15	570	
68	12.5*20	0.15	630	
	12.5*20	0.15	680	
100	12.5*25	0.15	720	
	16*20	0.15	760	
150	16*25	0.15	850	
	1	6.3*9	0.15	38
6.3*12		0.15	42	
1.5	6.3*9	0.15	50	
	6.3*12	0.15	54	
1.8	6.3*9	0.15	54	
	6.3*12	0.15	60	
2.2	6.3*9	0.15	60	
	6.3*12	0.15	68	
2.8	6.3*9	0.15	68	
	6.3*12	0.15	71	
3.3	6.3*9	0.15	74	
	6.3*12	0.15	80	
4.7	6.3*12	0.15	90	
	8*12	0.15	95	
5.6	8*9	0.15	92	
	8*12	0.15	98	
6.8	8*9	0.15	98	
	8*12	0.15	110	
8.2	8*12	0.15	115	
	8*16	0.15	120	
10	8*12	0.15	185	
	8*16	0.15	210	

WV (V _{dc})	Cap (μF)	Size ΦDxL(mm)	tanδ	Rated ripple current (mArms/105°C,100kHz)
200(2D)	15	8*16	0.15	250
		8*20	0.15	268
	22	8*20	0.15	400
		10*16	0.15	400
	33	10*20	0.15	450
		12.5*20	0.15	610
	68	12.5*20	0.15	635
		12.5*25	0.15	700
	100	16*20	0.15	735
		16*25	0.15	800
	150	16*25	0.15	855
		16*30	0.15	900
250(2E)	1	6.3*9	0.15	40
		6.3*12	0.15	46
	1.5	6.3*9	0.15	54
		6.3*12	0.15	58
	1.8	6.3*9	0.15	59
		6.3*12	0.15	63
	2.2	6.3*9	0.15	71
		6.3*12	0.15	75
	2.8	6.3*9	0.15	73
		6.3*12	0.15	78
	3.3	6.3*9	0.15	78
		6.3*12	0.15	83
	4.7	6.3*12	0.15	91
		8*12	0.15	102
	5.6	8*9	0.15	95
		8*12	0.15	105
	6.8	8*12	0.15	109
		8*16	0.15	115
	8.2	8*12	0.15	116
		8*16	0.15	120
	10	8*12	0.15	170
		8*16	0.15	210
	15	8*20	0.15	310
		10*16	0.15	320
	22	8*20	0.15	390
		10*16	0.15	400
	33	10*20	0.15	480
		12.5*20	0.15	530
47	12.5*20	0.15	627	
	16*20	0.15	660	
68	16*25	0.15	720	
	16*25	0.15	800	
100	16*30	0.15	880	
	16*30	0.15	930	
150	16*35	0.15	1030	

Radial Type

CD11GHS series

■ STANDARD RATINGS

WV (V _{dc})	Cap (μF)	Size ΦDxL(mm)	tanδ	Rated ripple current (mA _{rms} /105°C,100kHz)
350(2V)	1	6.3*9	0.20	58
		6.3*12	0.20	65
	1.5	6.3*9	0.20	68
		6.3*12	0.20	72
	1.8	6.3*9	0.20	74
		6.3*12	0.20	80
	2.2	6.3*9	0.20	85
		6.3*12	0.20	90
	2.8	8*9	0.20	101
		8*12	0.20	106
	3.3	8*9	0.20	106
		8*12	0.20	110
	4.7	8*12	0.20	115
		8*16	0.20	120
	5.6	8*12	0.20	130
		8*16	0.20	150
	6.8	8*16	0.20	160
		8*20	0.20	170
	8.2	8*20	0.20	189
		8*20	0.20	230
10	8*20	0.20	230	
	10*20	0.20	310	
22	12.5*20	0.20	430	
	12.5*20	0.20	515	
33	12.5*25	0.20	535	
	16*20	0.20	650	
68	18*20	0.20	726	
	18*25	0.20	910	
400(2G)	1	6.3*9	0.20	70
		6.3*12	0.20	75
	1.5	6.3*12	0.20	78
		8*12	0.20	80
	1.8	6.3*12	0.20	85
		8*12	0.20	90
	2.2	6.3*12	0.20	88
		8*12	0.20	105
	2.8	8*12	0.20	107
		8*16	0.20	109
	3.3	8*12	0.20	108
		8*16	0.20	112
	4.7	8*12	0.20	114
		8*16	0.20	120
	5.6	8*16	0.20	145
		8*20	0.20	155
	6.8	8*20	0.20	170
		10*12	0.20	160
	8.2	10*16	0.20	210
		10*20	0.20	230

WV (V _{dc})	Cap (μF)	Size ΦDxL(mm)	tanδ	Rated ripple current (mA _{rms} /105°C,100kHz)
400(2G)	10	10*16	0.20	225
		10*20	0.20	280
	12	10*20	0.20	290
		10*20	0.20	300
	15	12.5*20	0.20	320
		12.5*20	0.20	390
	22	12.5*25	0.20	450
		16*25	0.20	550
	47	16*25	0.20	640
		16*30	0.20	670
	56	16*30	0.20	680
		16*35	0.20	720
68	18*30	0.20	800	
	18*35	0.20	930	
100	18*40	0.20	950	
	450(2W)	1	8*12	0.20
1.5		8*12	0.20	75
1.8		8*12	0.20	90
2.2		8*12	0.20	103
		8*16	0.20	115
2.8		8*12	0.20	115
		8*16	0.20	120
3.3		8*16	0.20	128
4.7		8*20	0.20	140
5.6		10*16	0.20	158
6.8		10*16	0.20	180
		10*20	0.20	200
8.2		10*20	0.20	230
10		10*20	0.20	250
15		12.5*20	0.20	350
22		12.5*25	0.20	450
33		16*25	0.20	550
47		16*35	0.20	700
68	18*30	0.20	810	
100	18*40	0.20	950	

Solering Recommendation

■ Flow Soldering(Radial Lead Type)

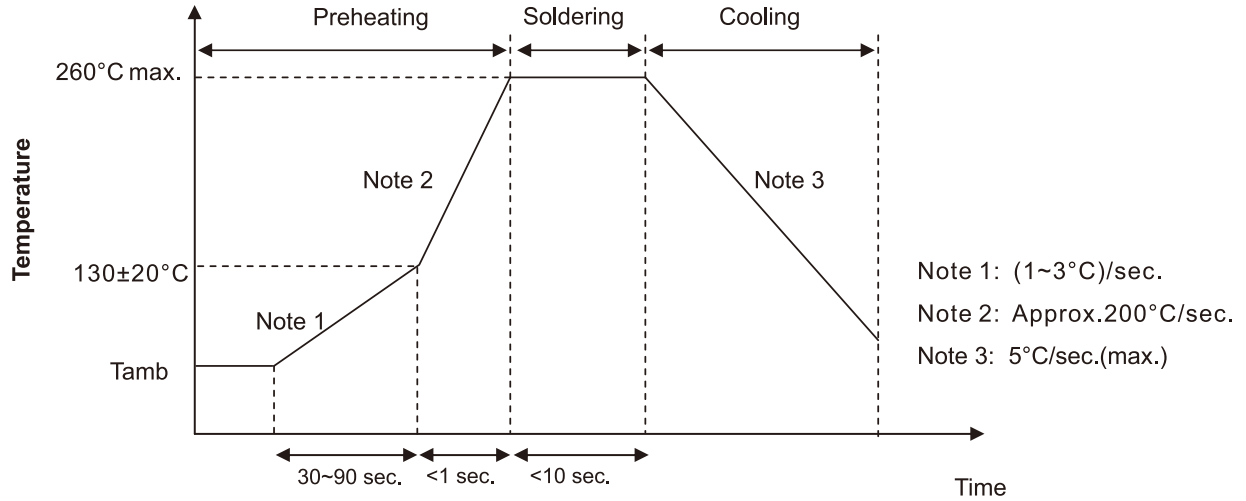

■ Reflow Soldering

- (For Polymer SMD Type)

Recommended Reflow Profile

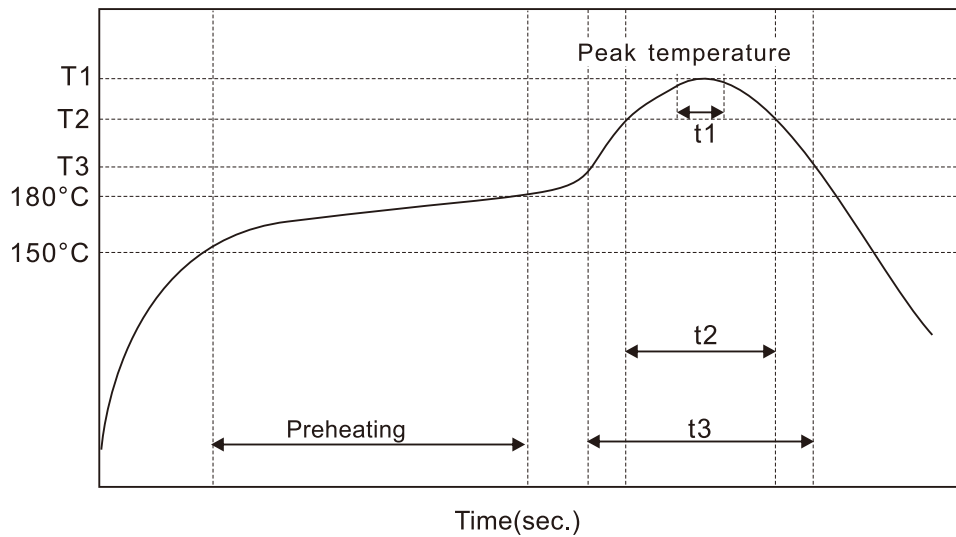

Item	Preheating	T1(°C)	T2(°C)	T3(°C)	t1(sec.)	t2(sec.)	t3(sec.)	Reflow cycle
Condition 1	150°C to 180°C Within 90sec.	≤260	230	200	≤10	≤40	≤60	1
Condition 2		≤250	230	200	≤10	≤40	≤60	2

● (For Liquid SMD Type)

Case size: $\Phi 6.3$ – $\Phi 10$ mm:

- Temperature at surface of capacitor shall not exceed $T^{\circ}\text{C}$.
- The duration for over 200°C temperature and $T_1^{\circ}\text{C}$ at surface of capacitor shall not exceed t and t_1 seconds, respectively.
- Preheat shall be done at 100°C to 200°C and for Maximum 180 seconds.

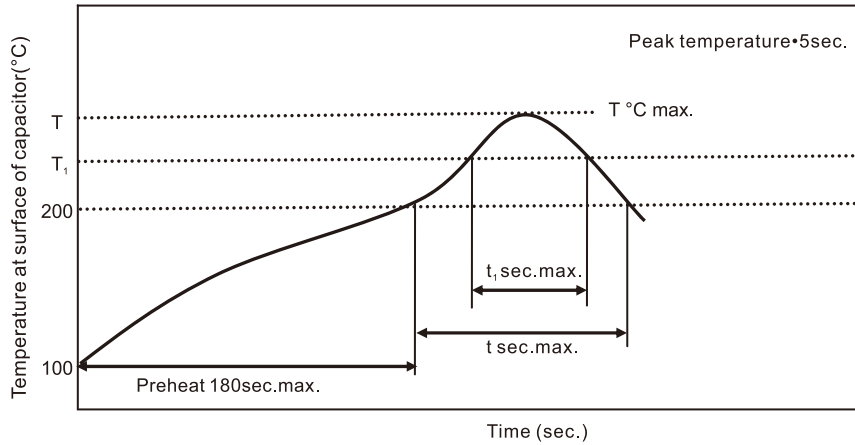

Case size (mm)	$T(^{\circ}\text{C})$ ①	$T_1(^{\circ}\text{C})$	$t(\text{sec.})$ ②	$t_1(\text{sec.})$ ③	Reflow cycle
$\Phi 6.3$	250	230	90	40	1
$\Phi 8$	240	230	90	30	1
$\Phi 10$	235	230	60	30	1

- ① Peak temperature
- ② The duration over 200°C (max.)
- ③ The duration over $T_1^{\circ}\text{C}$
- Please contact us if capacitors are subject to the conditions other than the allowable range of reflow.

Case size: $\Phi 12.5$ – $\Phi 18$ mm:

- Temperature at surface of capacitor shall not exceed $T^{\circ}\text{C}$.
- The duration for over 200°C temperature and $T_1^{\circ}\text{C}$ at surface of capacitor shall not exceed t and t_1 seconds, respectively.
- Preheat shall be done at 100°C to 180°C and for Maximum 150 seconds.

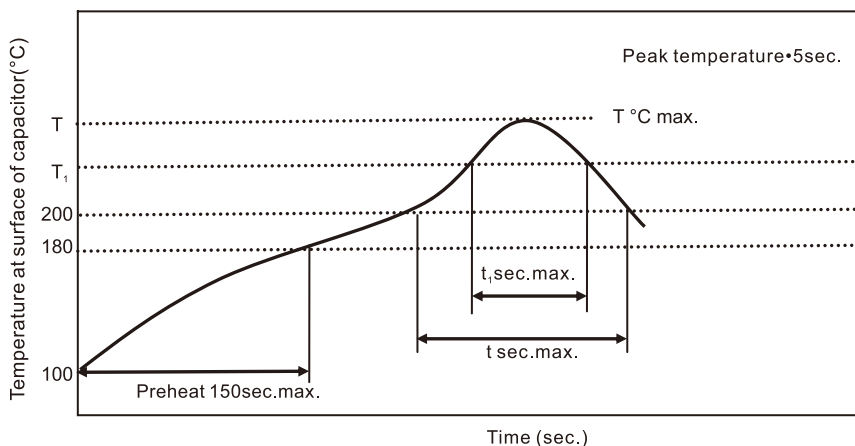

Case size (mm)	$T(^{\circ}\text{C})$ ①	$T_1(^{\circ}\text{C})$	$t(\text{sec.})$ ②	$t_1(\text{sec.})$ ③	Reflow cycle
$\Phi 12.5$ – $\Phi 18$	240	230	60	30	1

- ① Peak temperature
- ② The duration over 200°C (max.)
- ③ The duration over $T_1^{\circ}\text{C}$
- Please contact us if capacitors are subject to the conditions other than the allowable range of reflow.

X-ON Electronics

Largest Supplier of Electrical and Electronic Components

Click to view similar products for [Aluminium Electrolytic Capacitors - Radial Leaded](#) category:

Click to view products by [Aishi](#) manufacturer:

Other Similar products are found below :

[LXY50VB4.7M-5X11](#) [RFO-100V471MJ7P#](#) [ECE-A1EGE220](#) [1814181](#) [NCD681K10KVY5PF](#) [NEV1000M25EF-BULK](#) [NEV100M35DC](#)
[NEV100M63DE](#) [NEV220M25DD-BULK](#) [NEV.33M100AA](#) [NEV4700M50HB](#) [NEV.47M100AA](#) [NEVH1.0M250AB](#) [NEVH3.3M250BB](#)
[NEVH3.3M450CC](#) [KME50VB100M-8X11.5](#) [SG220M1CSA-0407](#) [ES5107M016AE1DA](#) [ESX472M16B](#) [476CKH100MSA](#) [477RZS050M](#)
[UVX1V101KPA1FA](#) [UVX1V222MHA1CA](#) [KME25VB100M-6.3X11](#) [VTL100S10](#) [VTL470S10](#) [511D336M250EK5D](#) [052687X](#) [ECE-](#)
[A1CF471](#) [EKXG451ELL820MM30S](#) [686CKR050M](#) [NRE-S560M16V6.3X7TBSTF](#) [ERZA630VHN182UP54N](#) [UPL1A331MPH](#)
[NEV1000M6.3DE](#) [NEV100M16CB](#) [NEV100M50DD-BULK](#) [NEV2200M16FF](#) [NEV220M50EE](#) [NEV2.2M50AA](#) [NEV330M63EF](#)
[NEV4700M35HI](#) [NEV4.7M100BA](#) [NEV47M16BA](#) [NEV47M50CB-BULK](#) [NEVH1.0M350AB](#) [NEVH2.2M160AB](#) [NEVH3.3M350BC](#)
[TER330M50GM](#) [477KXM035MGBWSA](#)