

## Part Numbering System



① Category code

Type	Code	
	2	3
Electrolytic Capacitor	E	
Conductive Polymer	S	

② Series code

Series name	Code	
	2	3
WH	W	H
CD11GE	G	E
CD11GES	G	X
CD11GAS	G	W
CD11GHS	G	S
NR	N	R
PZ	P	Z

③ Voltage code

WV (V <sub>dc</sub> )	Code	
	4	5
2.5	0	E
3	0	D
4	0	G
6.3	0	J
6.8	0	C
7	0	Q
7.5	0	A
10	1	A
12	1	T
16	1	C
25	1	E
35	1	V
40	1	G
50	1	H
63	1	J
80	1	B
100	1	K
120	2	B
160	2	C
180	2	L
200	2	D
220	2	N
250	2	E
315	2	F
350	2	V
380	2	P
400	2	G
420	2	T
450	2	W
500	2	H
550	2	J
600	2	K

④ Capacitance tolerance code

Tol. (%)	Code	
	6	
-10~+10	K	
-20~+20	M	
-10~+30	Q	
-10~+20	V	
0~+20	A	
-5~+20	C	
-10~-20	B	
-5~+5	D	
0~+10	E	
-5~-20	F	
-15~+5	N	

⑤ Capacitance code

Cap (μF)	Code		
	7	8	9
0.10	R	1	0
0.22	R	2	2
0.33	R	3	3
0.47	R	4	7
0.68	R	6	8
1	0	1	0
2.2	2	R	2
3.3	3	R	3
4.7	4	R	7
6.8	6	R	8
10	1	0	0
22	2	2	0
33	3	3	0
47	4	7	0
68	6	8	0
100	1	0	1
220	2	2	1
330	3	3	1
470	4	7	1
680	6	8	1
1000	1	0	2
2200	2	2	2
3300	3	3	2
4700	4	7	2
6800	6	8	2
10000	1	0	3
22000	2	2	3
33000	3	3	3
68000	6	8	3

⑥ Size code

ΦD (mm)	Code
4	C
5	D
6.3	E
8	F
10	G
11	H
12	J
12.5	W
13	K
14	X
16	L
18	M
19	Z
20	N
22	O
25	P
30	Q
35	R
40	Y
51.6	S
64.3	T
76.9	U
91	V
100	A

L (mm)	Code	
	11	12
5	0	5
7	0	7
11	1	1
12	1	2
16	1	6
20	2	0
25	2	5
30	3	0
35	3	5
40	4	0
46	4	6
50	5	0
60	6	0
80	8	0
100	A	0
115	B	5
120	C	0
130	D	0
140	E	0
160	G	0
200	K	0
220	M	0
236	N	6
250	P	0

⑦ Terminal code

Specification	Code		
	13	14	15
Bulk packing	O	-	-
Taping (SMD Type)	D	0	0
Φ4~8 Taping F=5.0mm	P	5	0
Φ10~12.5 Taping F=5.0mm	B	5	0
Lead Cut L=3.5mm	C	3	5
Lead Cut L=11.0mm	C	B	0
Lead Forming & Cut L=4.5mm	F	-	-
Kink & Cut L=4.5mm	J	-	-
Snap-in type Terminal 4.0mm in length	K	-	-
Three Terminals	T	-	-
Ring clip mounting standard design	A	0	0
Ring clip mounting special design	S	-	-

⑧ Sleeve/Marking code

Sleeve/Marking	Code	
	16	
PVC	C	
PET	T	
Dark blue	B	
Bright red	R	
Sky-blue	S	
Light blue	T	
Pink	Z	
Black	H	
Purple-blue	V	
Red	O	

Lead Forming  
Taping Specifications

Fig.1 code: X



Fig.2 code: B



Fig.3 code: B

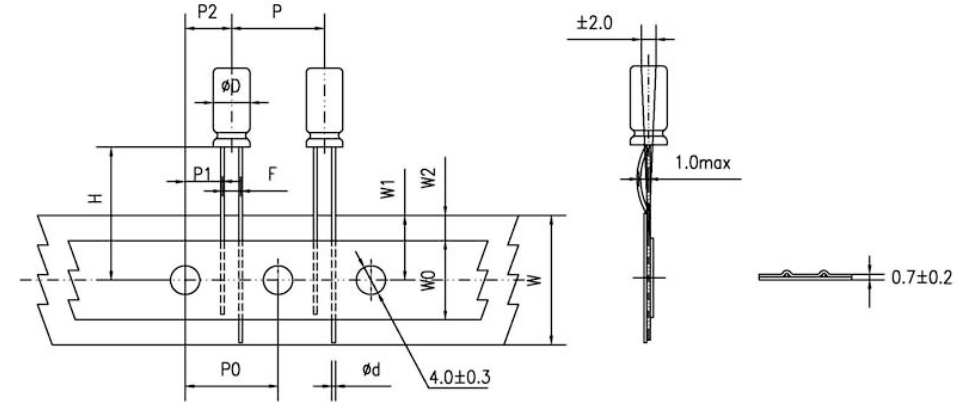

Fig.4 code: P



## Lead Forming

Specification Fig.1 & Fig.2 & Fig.3

Items	Symbol	Case size										Tolerance		
		4*5 4*7		5*5 5*7		5*11		6.3*5	6.3*7 6.3*9	6.3*11 6.3*12	8*5/7 8*9/11 8*11.5 8*12		8*16 8*20	10*9/12 10*12.5 10*13/16 10*20/25
Pin Code		X	B	X	B	X	B	B	B	B	B	B	B	
Lead wire diameter	Φd	0.45		0.45		0.5		0.45	0.5	0.5	0.45/0.5	0.6	0.6	±0.05
Pitch of body	P	12.7		12.7		12.7		12.7	12.7	12.7	12.7	12.7	12.7	±1.0
Feed hole pitch	P0	12.7		12.7		12.7		12.7	12.7	12.7	12.7	12.7	12.7	±0.2
Distance from hole center to lead	P1	5.1	5.6	5.1	5.35	5.1	5.35	5.1	5.1	5.1	4.6	4.6	3.85	±0.7
Distance from feed hole center to body center	P2	6.35		6.35		6.35		6.35	6.35	6.35	6.35	6.35	6.35	±1.0
Lead-to-lead distance	F	2.5	1.5	2.5	2.0	2.5	2.0	2.5	2.5	2.5	3.5	3.5	5.0	±0.5
Height of body from tape center	H	18.5		18.5		18.5		18.5	18.5	18.5	18.5	18.5	18.5	±0.75
Base tape width	W	18.0		18.0		18.0		18.0	18.0	18.0	18.0	18.0	18.0	±0.5
Adhesive tape width	W0	6.0		6.0		6.0		6.0	6.0	8.0	8.0	8.0	11.0	min
Hole position	W1	9.0		9.0		9.0		9.0	9.0	9.0	9.0	9.0	9.0	+0.75 -0.5
Hole down tape position	W2	3.0		3.0		3.0		3.0	3.0	3.0	3.0	3.0	3.0	max

Specification Fig.4

Items	Symbol	Case size									Tolerance
		4*5 4*7	5*5	5*7	5*11	6.3*5	6.3*7 6.3*9	6.3*11 6.3*12	8*5/7 8*9/11 8*11.5/12	8*16 8*20	
Pin Code		P	P	P	P	P	P	P	P	P	
Lead wire diameter	Φd	0.45	0.45	0.45	0.5	0.45	0.5	0.5	0.45/0.5	0.6	±0.05
Pitch of body	P	12.7	12.7	12.7	12.7	12.7	12.7	12.7	12.7	12.7	±1.0
Feed hole pitch	P0	12.7	12.7	12.7	12.7	12.7	12.7	12.7	12.7	12.7	±0.2
Distance from hole center to lead	P1	3.85	3.85	3.85	3.85	3.85	3.85	3.85	3.85	3.85	±0.7
Distance from feed hole center to body center	P2	6.35	6.35	6.35	6.35	6.35	6.35	6.35	6.35	6.35	±1.0
Lead-to-lead distance	F	1.5	2.0	2.0	2.0	2.5	2.5	2.5	3.5	3.5	±0.5
Lead to lead distance	F1	5.0	5.0	5.0	5.0	5.0	5.0	5.0	5.0	5.0	+0.8 -0.2
Height of body from tape center	H	18.5	18.5	18.5	18.5	18.5	18.5	18.5	18.5	18.5	±0.75
Lead wire clinch height	H0	16.0	16.0	16.0	16.0	16.0	16.0	16.0	16.0	16.0	±0.5
Base tape width	W	18.0	18.0	18.0	18.0	18.0	18.0	18.0	18.0	18.0	±0.5
Adhesive tape width	W0	6.0	6.0	6.0	6.0	6.0	6.0	8.0	8.0	8.0	min
Hole position	W1	9.0	9.0	9.0	9.0	9.0	9.0	9.0	9.0	9.0	+0.75 -0.5
Hole down tape position	W2	3.0	3.0	3.0	3.0	3.0	3.0	3.0	3.0	3.0	max

### Lead Forming

#### Lead Forming & Cut

Code:C  
RANGE:  $\Phi 4 \sim \Phi 18$

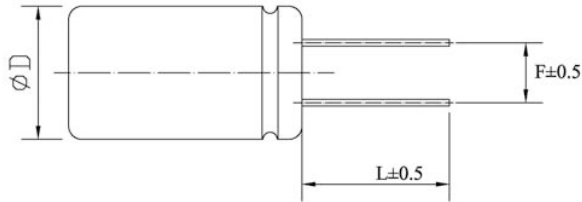

Code:F  
RANGE:  $\Phi 4 \sim \Phi 8$

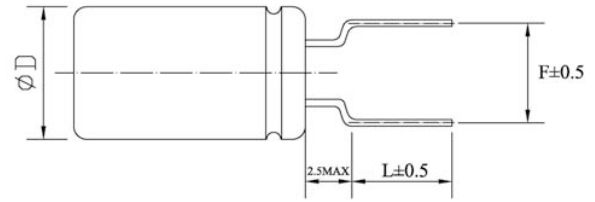

$\Phi D$	F	L	$\Phi D$	F	L
4	1.5	3.0~12.0	4	5.0	3.5, 4.5, 5.0, 7.0
5	2.0	3.0~12.0	5	5.0	3.5, 4.5, 5.0, 7.0
6.3	2.5	3.0~12.0	6.3	5.0	3.5, 4.5, 5.0, 7.0
8	3.5	3.0~12.0	8	5.0	3.5, 4.5, 5.0, 7.0
10	5.0	3.0~12.0	-	-	-
12.5	5.0	3.0~12.0	-	-	-
16	7.5	3.0~12.0	-	-	-
18	7.5	3.0~12.0	-	-	-

Code:J  
RANGE:  $\Phi 10 \sim \Phi 18$



$\Phi D$	F	L
10	5.0	4.0, 4.5, 5.0
12.5	5.0	4.0, 4.5, 5.0
16	7.5	4.0, 4.5, 5.0
18	7.5	4.0, 4.5, 5.0

### Solering Recommendation

■ Flow Soldering(Radial Lead Type)

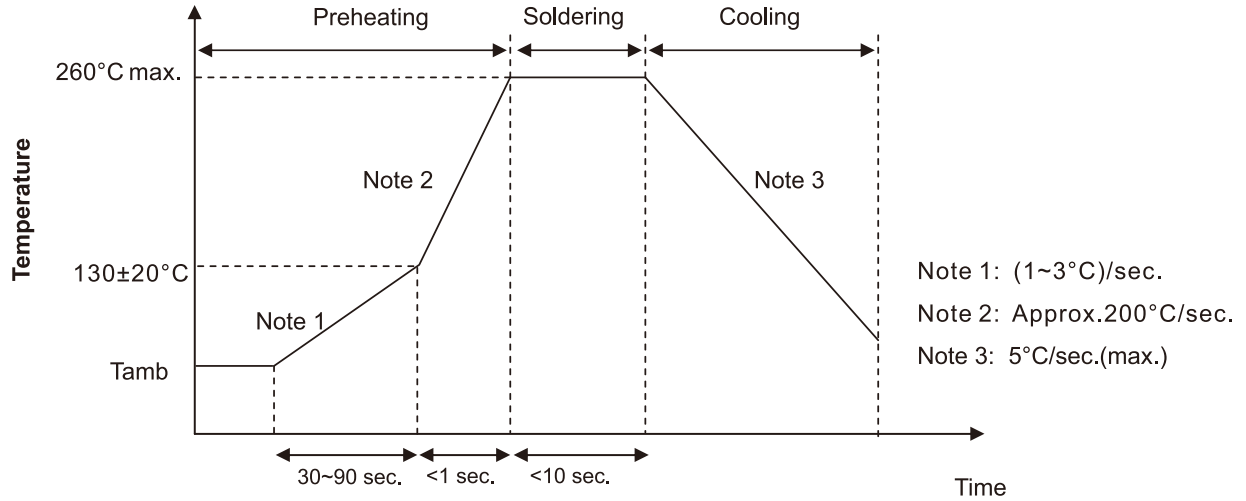

■ Reflow Soldering

- (For Polymer SMD Type)

#### Recommended Reflow Profile



Item	Preheating	T1(°C)	T2(°C)	T3(°C)	t1(sec.)	t2(sec.)	t3(sec.)	Reflow cycle
Condition 1	150°C to 180°C Within 90sec.	≤260	230	200	≤10	≤40	≤60	1
Condition 2		≤250	230	200	≤10	≤40	≤60	2

● (For Liquid SMD Type)

Case size:  $\Phi 6.3$ – $\Phi 10$ mm:

- Temperature at surface of capacitor shall not exceed  $T^{\circ}\text{C}$ .
- The duration for over  $200^{\circ}\text{C}$  temperature and  $T_1^{\circ}\text{C}$  at surface of capacitor shall not exceed  $t$  and  $t_1$  seconds, respectively.
- Preheat shall be done at  $100^{\circ}\text{C}$  to  $200^{\circ}\text{C}$  and for Maximum 180 seconds.

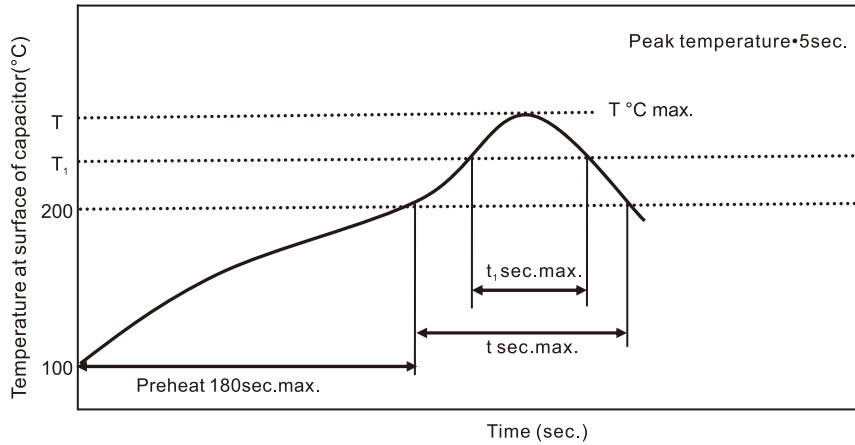

Case size (mm)	T(°C) ①	T <sub>1</sub> (°C)	t(sec.) ②	t <sub>1</sub> (sec.) ③	Reflow cycle
$\Phi 6.3$	250	230	90	40	1
$\Phi 8$	240	230	90	30	1
$\Phi 10$	235	230	60	30	1

- ① Peak temperature
- ② The duration over  $200^{\circ}\text{C}$  (max.)
- ③ The duration over  $T_1^{\circ}\text{C}$
- Please contact us if capacitors are subject to the conditions other than the allowable range of reflow.

Case size:  $\Phi 12.5$ – $\Phi 18$ mm:

- Temperature at surface of capacitor shall not exceed  $T^{\circ}\text{C}$ .
- The duration for over  $200^{\circ}\text{C}$  temperature and  $T_1^{\circ}\text{C}$  at surface of capacitor shall not exceed  $t$  and  $t_1$  seconds, respectively.
- Preheat shall be done at  $100^{\circ}\text{C}$  to  $180^{\circ}\text{C}$  and for Maximum 150 seconds.

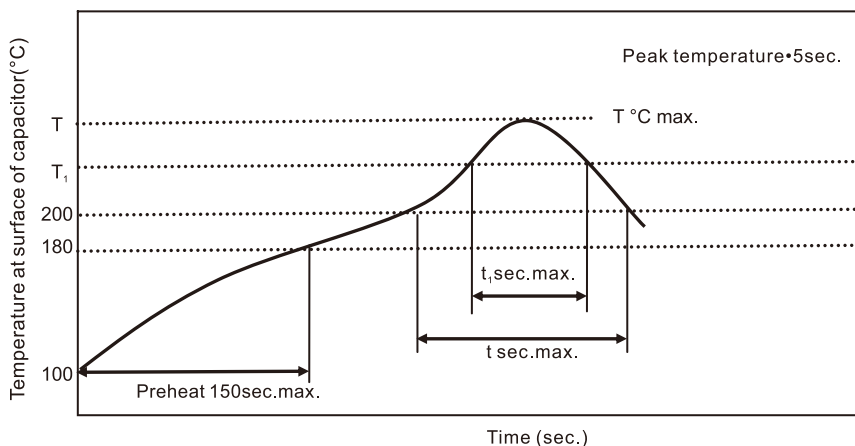

Case size (mm)	T(°C) ①	T <sub>1</sub> (°C)	t(sec.) ②	t <sub>1</sub> (sec.) ③	Reflow cycle
$\Phi 12.5$ – $\Phi 18$	240	230	60	30	1

- ① Peak temperature
- ② The duration over  $200^{\circ}\text{C}$  (max.)
- ③ The duration over  $T_1^{\circ}\text{C}$
- Please contact us if capacitors are subject to the conditions other than the allowable range of reflow.

## RM series

- Endurance: +105°C 10,000 hours
- Miniaturized, long life
- RoHS Compliant



### SPECIFICATIONS

Items	Characteristics							
Category Temperature Range	-40~+105°C							
Rated Voltage Range	10~100 V <sub>dc</sub>							
Capacitance Tolerance	±20%(M) (at 20°C, 120Hz)							
Leakage Current	I ≤ 0.01CV or 3μA, whichever is greater. Where, I: Max. leakage current (μA), C: Nominal capacitance (μF), V: Rated voltage (V) (at 20°C after 2 minutes)							
Dissipation Factor (tanδ)	Rated Voltage (V <sub>dc</sub> )	10	16	25	35	50	63	100
	tanδ (max.)	0.45	0.35	0.30	0.22	0.19	0.17	0.15
When nominal capacitance exceeds 1,000μF, add 0.02 to the value above for each 1,000μF increase. (at 20°C, 120Hz)								
Low Temperature Characteristics (Max. Impedance Ratio)	Rated Voltage (V <sub>dc</sub> )	10	16	25	35	50	63	100
	Z(-25°C)/Z(+20°C)	8	6	4	3			
	Z(-40°C)/Z(+20°C)	13	10	8	7 (at 120Hz)			
Endurance	The specifications listed below shall be met when the capacitors are restored to 20°C after DC voltage plus rated ripple current is applied for 10,000 hours at 105°C.							
	Capacitance Change	≤±25% of the initial value						
	D.F. (tanδ)	≤300% of the initial specified value						
	Leakage Current	≤The initial specified value						
Shelf Life	The following specifications shall be satisfied when the capacitors are restored to 20°C after leaving them under no load at 105°C for 1,000 hours.							
	Capacitance Change	≤±20% of the initial value						
	D.F. (tanδ)	≤200% of the initial specified value						
	Leakage Current	≤200% of the initial specified value						

### DIMENSIONS [mm]

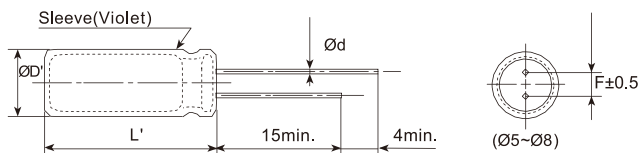

ØD	5	6.3	8
Ød	0.5	0.5	0.5
F	2.0	2.5	3.5
ØD'	ØD+0.5max.		
L'	L+1.5max.		

### PART NUMBERING SYSTEM

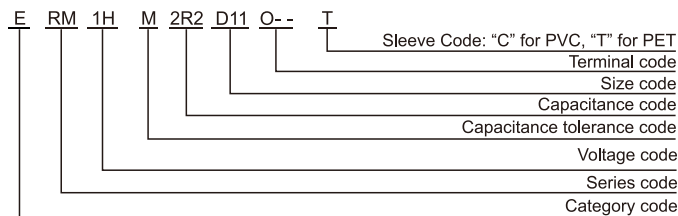

### RATED RIPPLE CURRENT MULTIPLIERS

Frequency correction factor for ripple current

Freq.(Hz) \ Cap.(μF)	120	1k	10k	100k
Cap.<22	0.42	0.60	0.80	1.00
22≤Cap.<47	0.55	0.75	0.90	1.00
Cap.≥47	0.70	0.85	0.95	1.00

The endurance of capacitors is shortened with internal heating produced by ripple current at the rate of halving the lifetime with every 5°C rise. When long life performance is required in actual use, the rms ripple current has to be reduced.

# RM series

■ STANDARD RATINGS

WV (V <sub>dc</sub> )	Cap ( $\mu$ F)	Size $\Phi$ DxL(mm)	$\tan\delta$	Rated ripple current (mA <sub>rms</sub> /105°C, 100kHz)
10(1A)	100	5*11	0.45	130
	220	6.3*11	0.45	210
	330	8*11	0.45	330
16(1C)	47	5*11	0.35	130
	100	6.3*11	0.35	210
	220	8*11	0.35	330
25(1E)	33	5*11	0.30	130
	47	5*11	0.30	130
	100	6.3*11	0.30	210
35(1V)	33	5*11	0.22	130
	47	6.3*11	0.22	210
	100	8*11	0.22	330
50(1H)	0.47	5*11	0.19	12
	1	5*11	0.19	25
	2.2	5*11	0.19	35
	3.3	5*11	0.19	70
	4.7	5*11	0.19	80
	10	5*11	0.19	90
	22	5*12	0.19	110
	33	6.3*11	0.19	190
	47	6.3*11	0.19	190
100	8*12	0.19	270	
63(1J)	10	5*11	0.17	80
	22	6.3*11	0.17	170
	33	6.3*12	0.17	170
	47	8*12	0.17	240
100(1K)	0.47	5*11	0.15	20
	1	5*11	0.15	40
	2.2	5*11	0.15	50
	3.3	5*11	0.15	60
	4.7	5*11	0.15	70
	10	6.3*12	0.15	150
	22	8*12	0.15	230



## X-ON Electronics

Largest Supplier of Electrical and Electronic Components

*Click to view similar products for [Aluminium Electrolytic Capacitors - Radial Leaded](#) category:*

*Click to view products by [Aishi](#) manufacturer:*

Other Similar products are found below :

[LXY50VB4.7M-5X11](#) [RFO-100V471MJ7P#](#) [ECE-A1EGE220](#) [1814181](#) [NCD681K10KVY5PF](#) [NEV1000M25EF-BULK](#) [NEV100M35DC](#)  
[NEV100M63DE](#) [NEV220M25DD-BULK](#) [NEV.33M100AA](#) [NEV4700M50HB](#) [NEV.47M100AA](#) [NEVH1.0M250AB](#) [NEVH3.3M250BB](#)  
[NEVH3.3M450CC](#) [KME50VB100M-8X11.5](#) [SG220M1CSA-0407](#) [ES5107M016AE1DA](#) [ESX472M16B](#) [476CKH100MSA](#) [477RZS050M](#)  
[UVX1V101KPA1FA](#) [UVX1V222MHA1CA](#) [KME25VB100M-6.3X11](#) [VTL100S10](#) [VTL470S10](#) [511D336M250EK5D](#) [052687X](#) [ECE-](#)  
[A1CF471](#) [EKXG451ELL820MM30S](#) [686CKR050M](#) [NRE-S560M16V6.3X7TBSTF](#) [ERZA630VHN182UP54N](#) [UPL1A331MPH](#)  
[NEV1000M6.3DE](#) [NEV100M16CB](#) [NEV100M50DD-BULK](#) [NEV2200M16FF](#) [NEV220M50EE](#) [NEV2.2M50AA](#) [NEV330M63EF](#)  
[NEV4700M35HI](#) [NEV4.7M100BA](#) [NEV47M16BA](#) [NEV47M50CB-BULK](#) [NEVH1.0M350AB](#) [NEVH2.2M160AB](#) [NEVH3.3M350BC](#)  
[TER330M50GM](#) [477KXM035MGBWSA](#)