

CONTENTS

Series Table	01
Group Chart	03
Aluminum Electrolytic Capacitors Show Various Failure Modes in Different Applications	06
Aluminum Electrolytic Capacitors Flow Chart	07
Application Guidelines	08
Soldering Recommendation	12
Part Numbering System	14
Lead Forming	16
Product Specifications	19

CAPACITOR SERIES TABLE, CONTENTS

Category & Series				Features	Endurance (hours)	Rated Voltage Range (Vdc)	Operating Temperature Range(°C)	Capacitance Range(μF)	Page
Conductive Polymer Aluminum Electrolytic Capacitors	Solid	Multilayer Type	A1	Low ESR	105°C 2,000	2-25	-55~+105	6.8-470	19
			A2	Low ESR	105°C 2,000	2-25	-55~+105	6.8-470	21
		Radial Type	PZ	Standard	105°C 2,000	6.3-100	-55~+105	4.7-5600	23
			PD	Low ESR, small size	105°C 2,000	6.3-35	-55~+105	47-4700	28
			PV	High voltage	125°C 2,000	35-100	-55~+125	4.7-1000	32
			PH	Huge capacitance, jumbo size	105°C 2,000	6.3-25	-55~+105	10-2200	34
			PT	Resistance to high temperature	125°C 2,000	6.3-25	-55~+125	22-5600	38
			PK	Resistance to high temperature	135°C 1,000	6.3-25	-55~+135	100-1500	42
			PF	Long life	105°C 3,000-5,000	6.3-100	-55~+105	4.7-5600	44
			PU	Ultra-low ESR	105°C 2,000	6.3-25	-55~+105	39-5600	49
			PR(new)	Long life, ripple current resistant	105°C 5,000	2.5-35	-55~+105	47-1500	53
			RZ(new)	Low ESR, ripple current resistant	105°C 2,000	2.5-35	-55~+105	47-1500	55
		RT(new)	Resistance to high temperature	125°C 2,000	2.5-35	-55~+125	47-1500	57	
		SMD Type	VZ	Standard	105°C 2,000	2.5-100	-55~+105	22-2200	59
	VS		Low ESR	105°C 2,000	2.5-25	-55~+105	27-2200	61	
	VD		High voltage	105°C 2,000	35-63	-55~+105	22-470	64	
	VT(new)		Resistance to high temperature	125°C 2,000	2.5-63	-55~+125	22-2200	66	
	Hybrid	Radial Type	DA(new)	Standard; Low ESR, high voltage resistant	125°C 4,000	25-80	-55~+125	15-470	68
SMD Type		SA(new)	Standard; Low ESR, high voltage resistant	125°C 4,000	25-80	-55~+125	15-470	70	
Aluminum Electrolytic Capacitors	Surface Mount Type	SMD Type	MK	Standard	105°C 2,000-3,000	6.3-450	-40~+105	1-1,000	72
			MF	Long life	105°C 6,000	6.3-450	-40~+105	1-470	74
			MA	Long life	105°C 10,000	16-450	-40~+105	2.2-1000	76
			MH	Resistant to 130°C, long life	130°C 1,000-5,000	10-450	-40~+130	2.2-4700	78
	Radial Type	Low Profile	M5	85°C 5mm Height, Standard type	85°C 1,000	4-50	-40~+85	0.1-470	80
			H5	105°C 5mm Height	105°C 1,000	6.3-50	-40~+105	0.1-100	82
			M7	85°C 7mm Height, Standard type	85°C 1,000	4-100	-40~+85	0.1-330	84
			H7	105°C 7mm Height, Standard type	105°C 1,000	6.3-50	-40~+105	0.1-100	86
			L7	105°C 7mm Height, Long life	105°C 2,000	6.3-63	-40~+105	0.1-220	88
		Standard	WK	Standard series for general purpose	85°C 2,000	6.3-100 160-450	-40~+85 -25~+85	0.1-22000	90
			WH	Standard series for general purpose	105°C 2,000	6.3-400 450-500	-40~+105 -25~+105	0.1-22000	93
			HP	Standard bi-polarized series	105°C 1,000	6.3-100	-40~+105	0.47-6800	96
		High reliability, long life. Especially designed for LED driver, electronic ballast, electronic energy saving lamp	CD11GC	Resistant to 130°C, Long life	130°C 4,000-5,000 105°C 15,000-20,000	160-450	-40~+130	1-220	98
			CD11GES	Resistant to 130°C, miniaturized, high ripple current and long life	130°C 3,000 105°C 12,000	160-450	-40~+130	1-220	100
			CD11GK	Extremely miniaturized, long life	105°C 12,000-20,000	160-450	-40~+105	1-47	103
			CD11GN	Resistant to 130°C, miniaturized and long life	130°C 1,000-2,000 105°C 8,000-12,000	160-450	-40~+130	1-330	105
			CD11GZ(new)	Long life, suited for outdoor lighting	105°C 12,000	250-500	-40~+105	10-150	108
			CD11GAS	Miniaturized and long life	105°C 10,000 105°C 8,000	140-450 500	-40~+105	1-470	110
			CD11GD (upgrade)	Miniaturized and long life	105°C 8,000	140-450	-40~+105	1-330	114
			CD11GHS	Miniaturized, long life and high cost performance	105°C 6,000	140-500	-40~+105	1-330	118
	CD11GM		Miniaturized and high cost performance	105°C 3,000	160-450	-40~+105	1-100	121	
	For Input And Output Circuit	RR	High frequency, low impedance, Standard	105°C 2,000	6.3-50	-40~+105	22-6800	123	
		RE	Miniaturized, low impedance	105°C 2,000-4,000	6.3-100	-40~+105	15-4700	125	
		RF	High ripple current, low impedance	105°C 3,000-6,000	6.3-120	-40~+105	6.8-6800	128	
		RS	High ripple current, low impedance and long life	105°C 4,000-10,000	6.3-120	-40~+105	6.8-18000	131	

Continued

Category & Series			Features	Endurance (hours)	Rated Voltage Range (Vdc)	Operating Temperature Range(°C)	Capacitance Range(µF)	Page		
Aluminum Electrolytic Capacitors	Radial Type	For Input And Output Circuit	RN	Miniaturized, large capacitance	105°C 5,000-10,000	25-120	-40~+105	2.7-1500	135	
			RZ	Miniaturized, long life and low impedance, high reliability	105°C 6,000-10,000	6.3-50	-40~+105	22-10000	138	
			RJ	Downsized, long life and low impedance	105°C 8,000-12,000	10-120	-40~+105	8.2-5600	140	
			RH	High frequency, low impedance	105°C 2,000-3,000	160-400 450	-40~+105 -25~+105	0.47-470	143	
			HH	High ripple current	105°C 2,000	400 420-450	-40~+105 -25~+105	22-120	145	
			HS	High ripple current	105°C 3,000-5,000	160-400 450	-40~+105 -25~+105	0.47-330	147	
			HF	Long life and high ripple current	105°C 5,000-10,000	160-400 450	-40~+105 -25~+105	1-330	149	
			HL	Long life, downsized and high ripple current	105°C 8,000-12,000	160-400 450-500	-40~+105 -25~+105	6.8-680	151	
			RK(upgrade)	Miniaturized, high voltage. Specially designed for charger	105°C 2,000	400 450-550	-40~+105 -25~+105	2.2-68	154	
		High Reliability	RG	"GBL"system,high reliability	105°C 2,000-8,000	6.3-63	-55~+105	10-10000	156	
			RV	High reliability, low impedance, small size	105°C 4,000-5,000	6.3-35	-55~+105	330-6800	158	
			ML	105°C 5-9mm Height, long life	105°C 3,000-5,000	6.3-50	-40~+105	1-1000	160	
			RM	Miniaturized, long life	105°C 10,000	10-100	-40~+105	0.47-330	162	
			NB(upgrade)	Resistant to 130°C,long life	130°C 2,000-5,000	10-120	-40~+130	1-4700	164	
		Special Purpose	RD	Low water content series	105°C 2,000-5,000	6.3-100	-40~+105	0.47-15000	166	
			GH(upgrade)	For intelligent instrument, high reliability	105°C 5,000-8,000 105°C 10,000	6.3-100 160-450	-40~+105	1-18000	169	
			LL	Extremely low leakage current	105°C 2,000	6.3-100	-40~+105	0.47-2200	173	
			BG	Large capacitance, low impedance; For airbags	105°C 5,000	25-35	-55~+105	1000-11000	176	
	BH(new)		For automobile electronics	130°C 3,000	25-400	-40~+130	12-11000	178		
	Snap-in&Lug Terminal Type	General Purpose	LK(upgrade)	Standard series for general purpose	85°C 2,000	10-100 160-500	-40~+85 -25~+85	56-82000	181	
			LH(upgrade)	Withstand high temperature, general purpose	105°C 2,000	10-100 160-500	-40~+105 -25~+105	47-56000	187	
			LC	Wide temperature range; miniaturized	105°C 2,000	400-500	-40~+105	47-680	193	
			LS	Downsized, Long life	85°C 3,000	160-600	-25~+85	47-3300	195	
			LM	Downsized, long life	105°C 3,000	160-550	-25~+105	47-3300	199	
			LP	High ripple current, long life	105°C 3,000	400-450	-40~+105	82-820	203	
		High Reliability	LQ	Long life	85°C 5,000	160-450	-25~+85	68-2200	205	
			LG	Long life, high ripple current	85°C 12,000	350-450	-25~+85	470-2700	209	
			LT	Long life, downsized	105°C 5,000	160-550	-25~+105	82-2700	211	
			LX	Extremely long life	105°C 7,000	160-450	-25~+105	47-2200	215	
			LB	High reliability, long life	105°C 10,000	200-450	-25~+105	39-1500	218	
			LU	No sparks against DC overvoltage	105°C 2,000	200-450	-25~+105	56-1200	220	
		Screw-mount Terminal Type	Standard	NR	Screw terminal, standard series	85°C 2,000	350-550	-25~+85	1000-15000	222
				NS	Screw terminal, standard series	105°C 2,000	350-450	-25~+105	1000-15000	224
			Long Life	NX	High ripple, downsized, long life	85°C 5,000	350-500	-25~+85	1000-12000	226
				NL	Long life	85°C 12,000	350-450	-25~+85	1500-15000	228
				NE	High ripple, long life	85°C 20,000	350-450	-25~+85	1500-15000	230
NT(new)				Long life	105°C 3,000	350-450	-25~+105	1000-15000	232	
NF	Long life			105°C 5,000	350-450	-25~+105	1000-15000	234		
NK	High ripple, long life			105°C 5,000	350-450	-25~+105	1000-15000	236		

Group Chart

CONDUCTIVE POLYMER ALUMINUM SOLID CAPACITORS

Multilayer Type

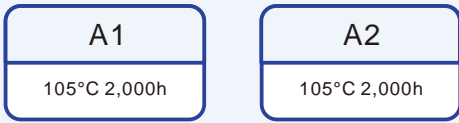

Radial Type

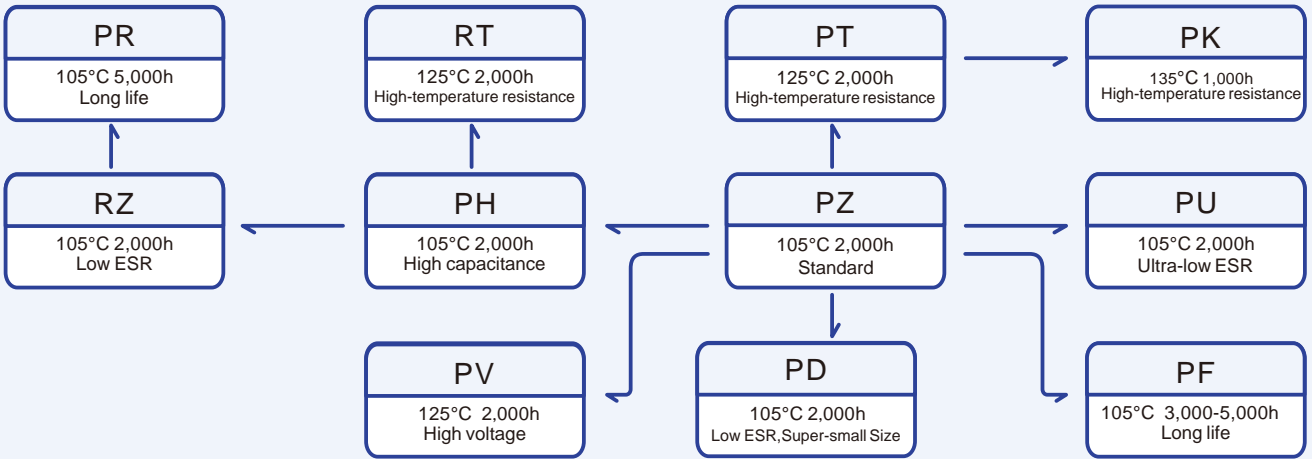

Surface Mount Type

Downsized & Low Profile

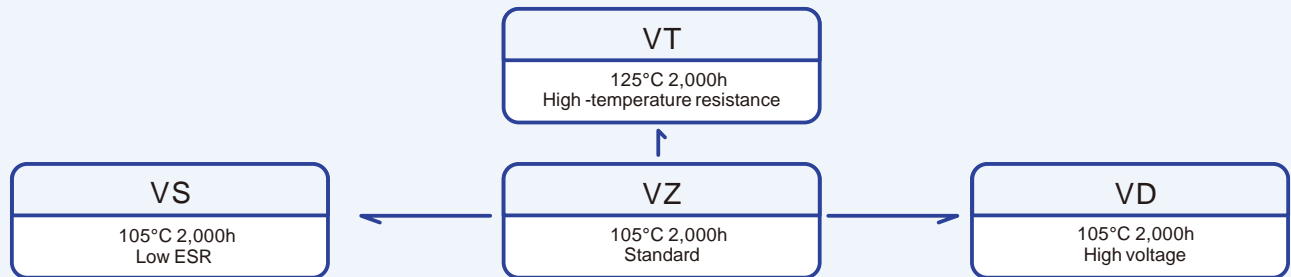

CONDUCTIVE POLYMER HYBRID ALUMINUM ELECTROLYTIC CAPACITORS

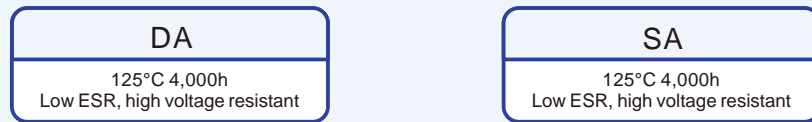

ALUMINUM ELECTROLYTIC CAPACITORS

Surface Mount Type

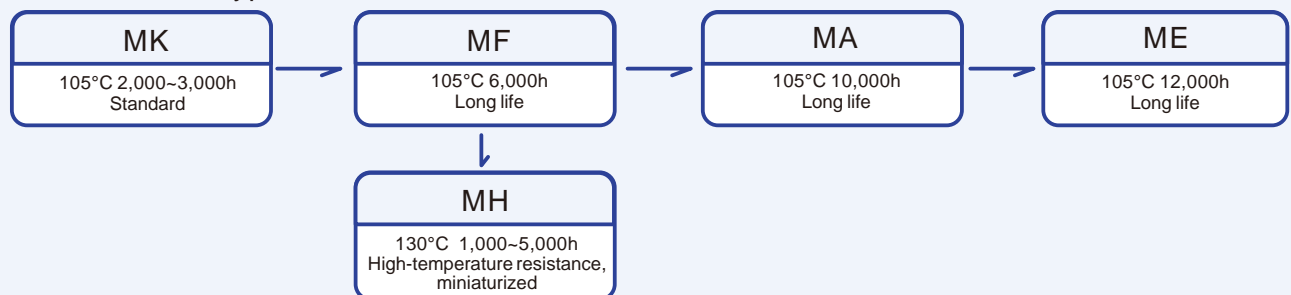

RADIAL TYPE

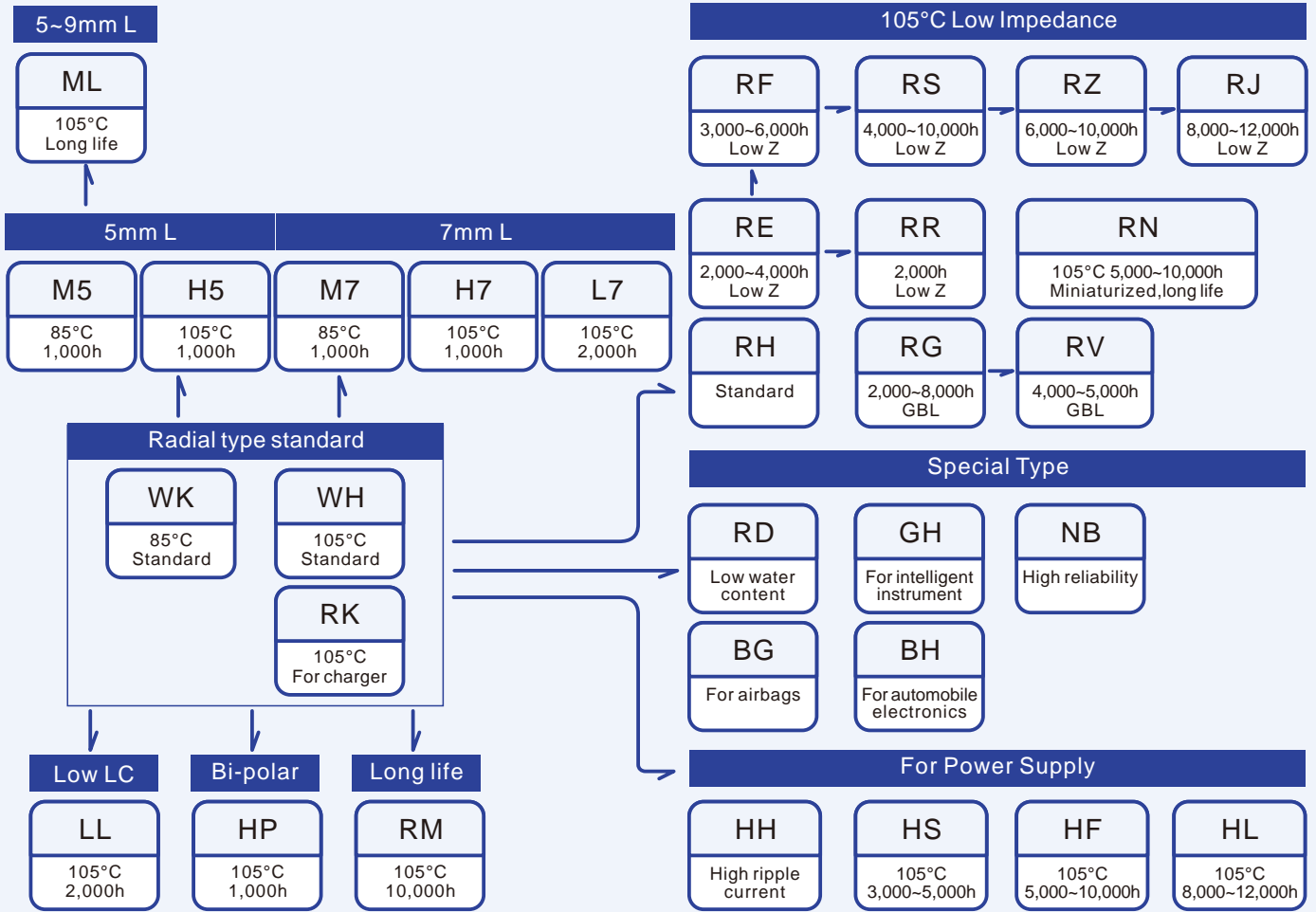

For Lighting Application

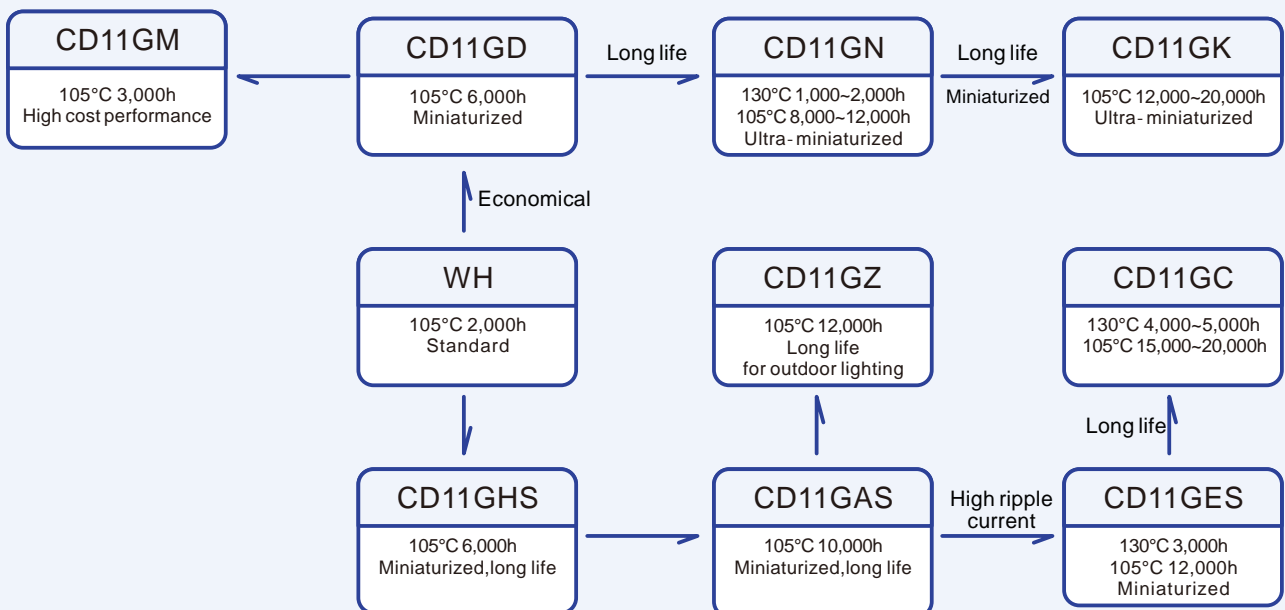

Snap-in & Lug Terminal Type

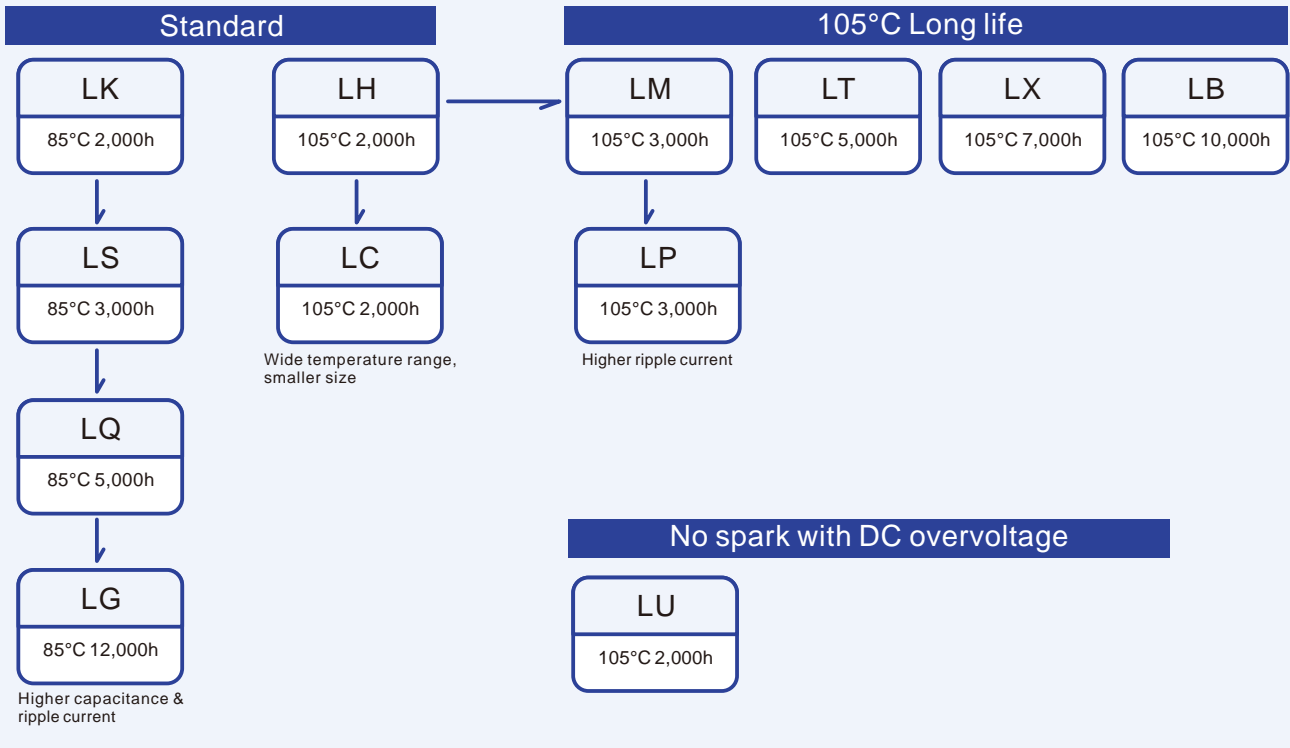

Screw-mount Terminal Type

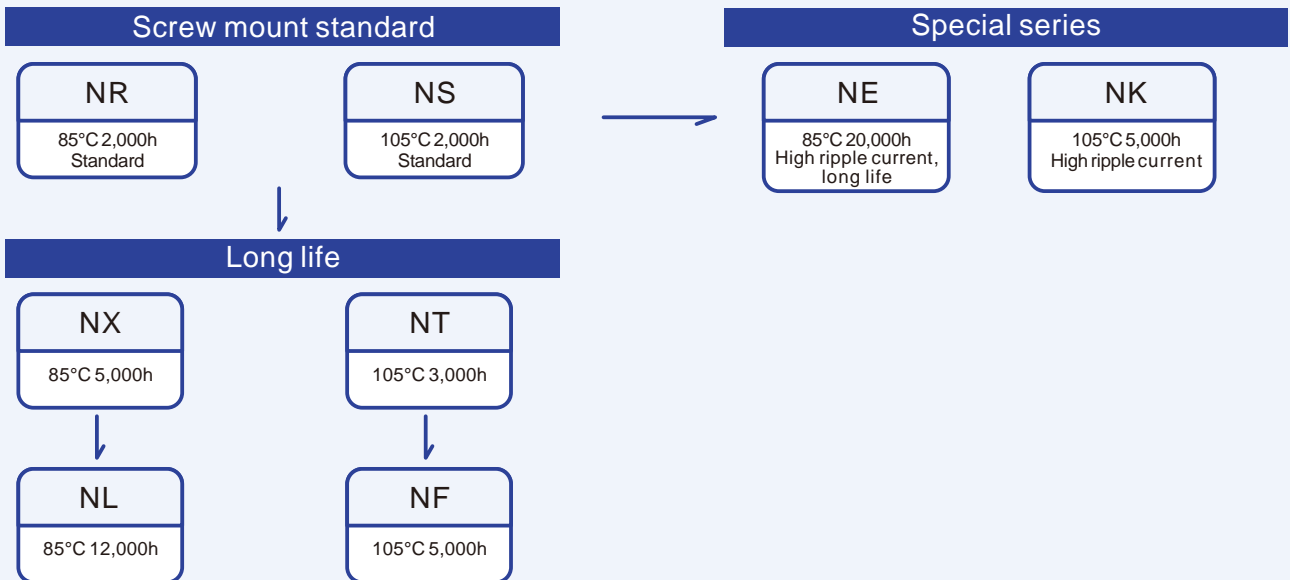

■ Failure Modes

Aluminum Electrolytic Capacitors Show Various Failure Modes in Different Applications

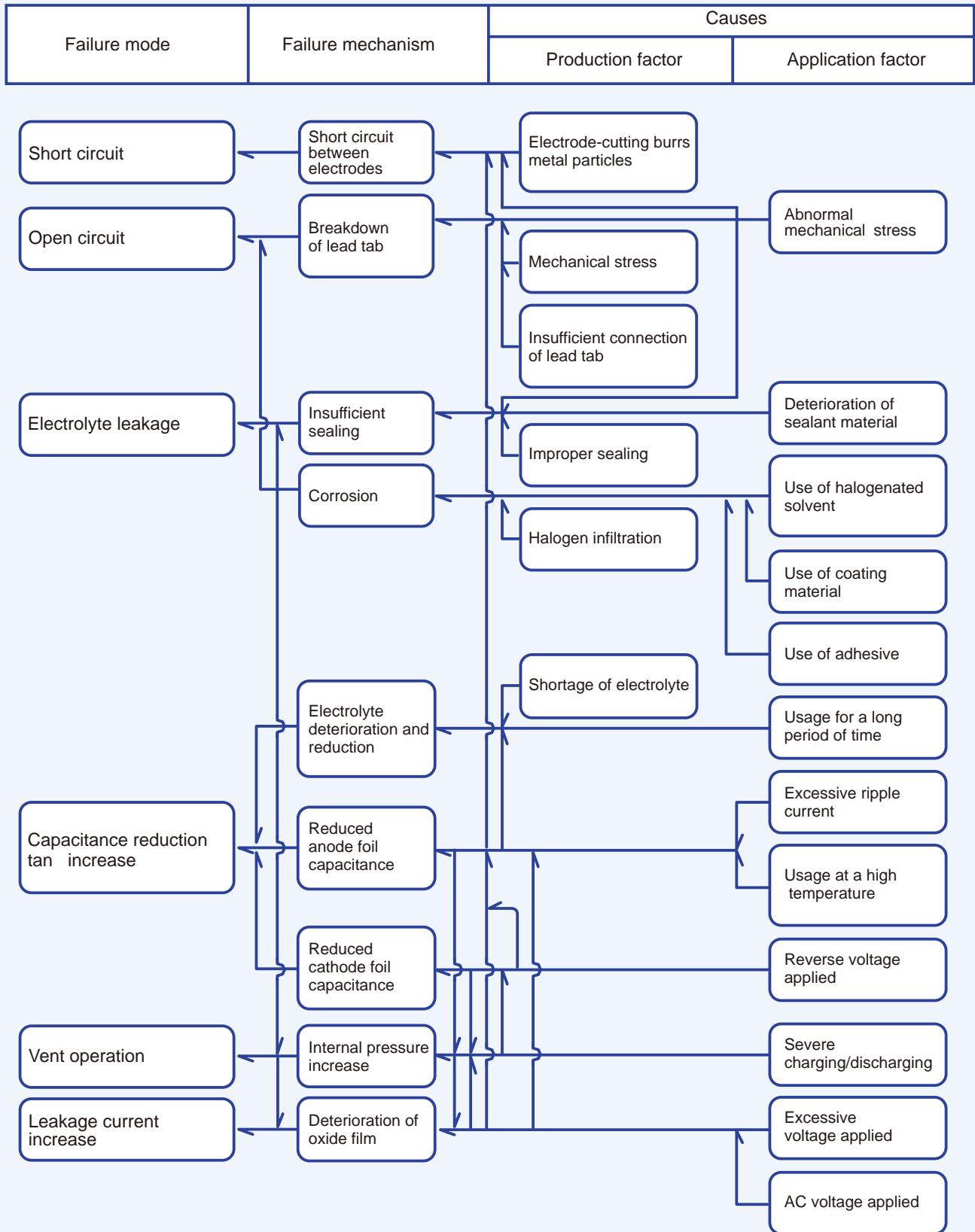

■ Flow Chart

Aluminum Electrolytic Capacitors Flow Chart

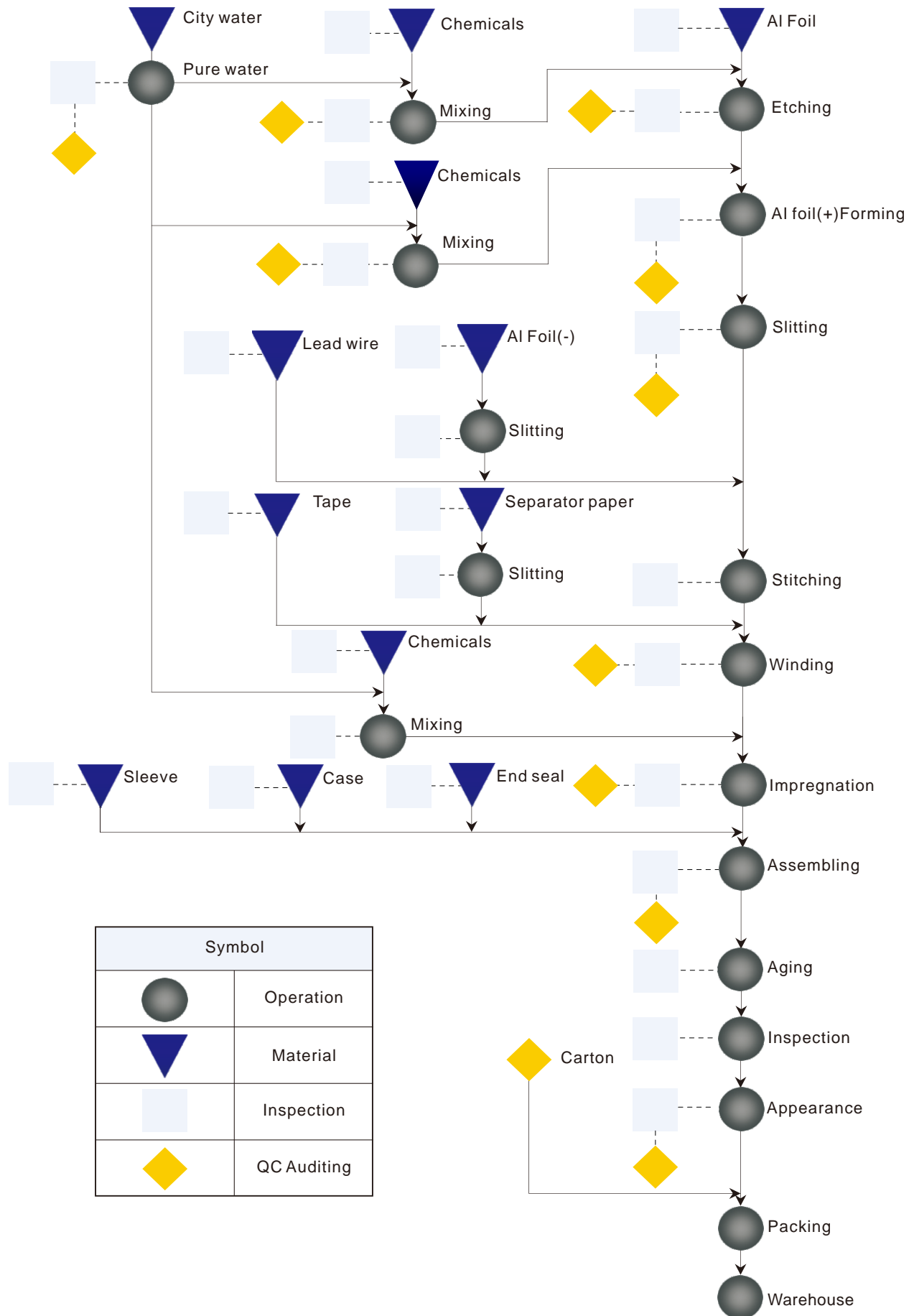

Application Guidelines for Conductive Polymer Aluminum Solid Electrolytic Capacitors

1. Polarity

AishiCAP is a solid aluminum electrolytic capacitor with positive and negative electrodes. Do not reverse the polarity when using. If it is used with the polarities reversed, its life may be shortened because of increasing leakage current or short circuit.

2. Prohibited circuits

Since leakage current may be increased during soldering and other processes, AishiCAP cannot be used in the following circuits.

- 1) High impedance circuits;
- 2) Coupling circuits;
- 3) Time-limited constant circuits;
- 4) Connection of two or more capacitors in series for higher withstand voltage;
- 5) Circuits to get bad influence by large leakage current.

* In addition to the leakage current fluctuation, the operational conditions such as characteristics at high and low temperature, damp heat and endurance stipulated in the specifications will affect the capacitance. The fluctuation of the capacitance may cause problem if it is used as a time-limited constant capacitor, which is extremely sensitive to the fluctuation of the capacitance. So do not use it as a time-limited constant capacitor.

Additionally, please contact Hunan Aihua Group Co., Ltd. for usage of two or more AishiCAP in series for voltage proof.

3. Over voltage

Over voltage cannot be applied even for an instant as it may cause a short circuit.

4. Sudden charge and discharge

Sudden charge and discharge are prohibited (for maintenance of high reliability). A protection circuit is recommended when a sudden charge or discharge causes excessive rush current because this is a main cause of short circuits and large leakage current. Use protection circuits if the rush current exceeds 10A. If the rush current exceeds 10 times the maximum allowable ripple current of AishiCAP, be sure to insert a protection resistor of about 1k Ω for charge and discharge when measuring the leakage current.

5. Considerations when soldering

The soldering conditions are to be within the range prescribed in specifications. If the specifications are not followed, there is a possibility of the intensive increase of leakage current, and the capacitance reduction. Things to be noted before mounting:

- a) Do not reuse capacitors that have been assembled in a set and energized. Capacitors that have been removed for measuring electrical characteristics during a periodic inspection also cannot be reused.
- b) Leakage current may increase when capacitors are stored for one year. In this case, apply rated voltage for 2 hours at 105°C with load of 1k Ω resistor.
- c) Reflow soldering
Do not apply reflow soldering to radial lead type capacitors.
- d) Handling after soldering
Do not tilt, bend or twist the AishiCAP;
Do not move the PCB with catching AishiCAP itself.
When stacking PCB, make sure that the AishiCAP does not touch other PCB or components.
Do not dump the AishiCAP with other objects.

6. Application of AishiCAP in industrial equipments

To ensure reliability, when using the AishiCAP in industrial equipments, appropriate design is required.

7. Use of AishiCAP for human life equipments

In case of using in equipments regarding human life (e.g. Space equipment, aeronautic equipment and atomic equipment, etc.), be sure to consult with Hunan Aihua Group Co., Ltd. Don't use products without recognition document of Hunan Aihua Group Co., Ltd.

8. Storage

- 1) Store AishiCAP with the temperature range between 5 to 35°C (If between 35 to 85°C, it should be less than three months), and the relative humidity of 75% without direct sunshine and store AishiCAP in the package states if possible.
- 2) It is recommended that you open the bag just before use and use up as early as possible.
- 3) Store the capacitors in places free from water, oil or salt water or in condensation status.
- 4) Never store AishiCAP in any area filled with poisonous gases (including hydrogen sulfide, sulfurous acid, nitrous acid, chlorine and ammonia).
- 5) Store the capacitors in places free from ozone, ultraviolet rays or radiation.

Before unseal: within 1 year after delivery

After opening: within 7 days

9. Cleaning

Concerning about HCFC, soak with high concentration alcohol, petroleum and terpene, water or surface active agent and other solvents (separate or blended), wash under the maker's recommendation by ultrasonic wave, boiling and evaporation, etc. Please contact us if you require further details.

10. Notes on circuit designs for AishiCAP

10.1 Performance

Use AishiCAP within the rated performance ranges defined in this specification.

10.2 Operating temperature and ripple current

If AishiCAP is used at a temperature higher than the upper category temperature (105°C), or excess ripple current flows through AishiCAP, there are high possibilities of service life reduction or leakage current increase to cause AishiCAP defective.

10.3 Leakage current

The leakage current of AishiCAP may increase slightly by soldering conditions. The application of DC voltage enables the capacitors to be repaired by itself and this leads the leakage current to be smaller gradually.

10.4 Applied voltage

For the reliability of AishiCAP, it is recommended that the voltage applied to AishiCAP should be less than 80% of the rated voltage. Peak value of the DC and AC voltage should not exceed its rated voltage.

10.5 Failure mode

AishiCAP contains conductive polymer. The life ends mostly due to random failure mode, mainly short circuit. In case of short circuit, AishiCAP can be overheated by continuous current flow, and then Al case of AishiCAP would be separated by increased internal pressure.

Application Guidelines for Aluminum Electrolytic Capacitors

■ Designing Device Circuits

1. Select the capacitors to suit installation and operating conditions, and use the capacitors to meet the performance limits prescribed in this catalog or the product specifications.

2. Polarity

Aluminum Electrolytic Capacitors are polarized.

Apply neither reverse voltage nor AC voltage to polarized capacitors. Using reversed polarity causes a short circuit or venting. Before use, refer to the catalog, product specifications or capacitor body to identify the polarity marking. (The shape of rubber seal does not represent the directional rule for polarity.) Use a bi-polar type of non-solid aluminum electrolytic capacitor for a circuit where the polarity is occasionally reversed. However, note that even a bi-polar aluminum electrolytic capacitor must not be used for AC voltage applications.

3. Operating voltage

Do not apply a DC voltage which exceeds the full rated voltage. The peak voltage of a superimposed AC voltage (ripple voltage) on the DC voltage must not exceed the full rated voltage.

A surge voltage value, which exceeds the full rated voltage, is prescribed in the catalogs, but it is a restricted condition, for especially short periods of time.

4. Ripple current

The rated ripple current has been specified at a certain ripple frequency. The rated ripple current at several frequencies must be calculated by multiplying the rated ripple current at the original frequency using the frequency multipliers for each product series.

5. Category temperature

The use of a capacitor outside the maximum rated category temperature will considerably shorten the life or cause the capacitor to vent.

The relation between the lifetime of aluminum electrolytic capacitors and ambient temperature follows Arrhenius' rule that the lifetime is approximately halved with each 10°C rise in ambient temperature.

6. Life expectancy

Select the capacitors to meet the service life of a device.

7. Charge and discharge

Do not use capacitors in circuits where heavy charge and discharge cycles are frequently repeated. Frequent and sharp heavy discharging cycles will result in decreasing capacitance and damage to the capacitors due to generated heat. Specified capacitors can be designed to enduring such a condition. Rapid charging/discharging may be repeated in a circuit where the ripple voltage at the two terminals of the aluminum electrolytic capacitor fluctuates greatly. If the variation range of voltage exceeds 70Vp-p, please consult us.

8. Failure modes of capacitors

Non-solid aluminum electrolytic capacitors, in general, have a lifetime which ends in an open circuit, the period is dependent upon temperature. Consequently, lifetime of capacitors can be extended by reducing the ambient temperature and/or ripple current.

9. Insulating

- a) Electrically isolate the following parts of a capacitor from the negative terminal, the positive terminal and the circuit traces.
 - The outer can case of a non-solid aluminum electrolytic capacitors.
 - The dummy terminal of a non-solid aluminum electrolytic capacitors, which is designed for mounting stability.
- b) The outer sleeve of a capacitor is not assured as an insulator (Except for screw type). For applications that require an insulated outer sleeve, a custom-designed capacitor is recommended.

10. Conditions

Do not use/expose capacitors to the following conditions.

- a) Oil, water, salty water. Avoid storage in damp locations.
- b) Direct sunlight.
- c) Toxic gases such as hydrogen sulfide, sulfurous acid, nitrous acid, chlorine or its compounds, and ammonium.
- d) Ozone, ultraviolet rays or radiation.
- e) Severe vibration or mechanical shock conditions beyond the limits prescribed in the catalogs or the product specification.

11. Mounting

- a) The electrolytic paper and the electrolytic-conductive electrolyte in a non-solid aluminum electrolytic capacitor are flammable. Leaking electrolyte on a printed circuit board can gradually erode the copper traces, possibly causing smoke or burning by shortcircuiting the copper traces.

Verify the following points when designing a PC board.

- Provide the appropriate hole spacing on the PC board to match the terminal spacing of the capacitor.
- Make the following open space over the vent so that the vent can operate correctly.

Case diameter	Clearance
Ø6.3 to Ø16mm	2mm minimum
Ø18 to Ø35mm	3mm minimum
Ø40mm or more	5mm minimum

- Do not place any wires or copper traces over the vent of the capacitor.
- Installing a capacitor with the vent facing the PC board needs an appropriate ventilation hole in PC board.
- Do not pass any copper traces beneath the seal side of a capacitor. The trace must pass 1 or 2mm to the side of the capacitor.
- Avoid placing any heat-generating objects adjacent to a capacitor or even on the reverse side of the PC board.
- Do not pass anything via holes or underneath a capacitor.
- In designing double-sided PC boards, do not locate any copper trace under the seal side of a capacitor.
- b) Do not mount the terminal side of a screw mount capacitor downwards. If a screw terminal capacitor is mounted on its side, make sure the positive terminal is higher than the negative terminal.

Do not fasten the screws of the terminals and the mounting clamps over

the specified torque prescribed in the catalog or the product specifications.

- c) For a surface mount capacitor, design the copper pads of the PC board in accordance with the catalog or the product specifications.

12. Others

- a) The electrical characteristics of capacitors vary in respect to temperature, frequency and service life. Design the device circuits by taking these changes into account.
- b) Capacitors mounted in parallel need the current to flow equally through the individual capacitors.
- c) Capacitors mounted in series require resistors in parallel with the individual capacitors to balance the voltage.
- d) Using capacitor for applications which always consider safety. Consult with our factory before use in applications which can affect human life.(space equipment, aerial equipment, nuclear equipment, medical equipment, vehicle control equipment, etc.) Please note that the product which is designed only for specific usage can not be used for other purposes.(ex.Photo flash type, etc.)

Installing Capacitors

1. Installing

- a) Used capacitors are not reusable, except in the case that the capacitors are detached from a device for periodic inspection to measure their electrical characteristics.
- b) If the capacitors have self-charged, discharge the capacitors through a resistor of approximately 1k before use.
- c) If capacitors are stored at a temperature of 35°C or more and more than 75% RH, the leakage current may increase. In this case, they can be reformed by applying the rated voltage through a resistor of approximately 1k .
- d) Verify the rated capacitance and voltage of the capacitors when installing.
- e) Verify the polarity of the capacitors.
- f) Do not use the capacitors if they have been dropped on the floor.
- g) Do not deform the cases of capacitors.
- h) Verify that the lead spacing of the capacitor fits the hole spacing in the PC board before installing the capacitors. Some standard pre-formed leads are available.
- i) For pin terminals or snap-in terminals, insert the terminals into PC board and press the capacitor downward until the bottom of the capacitor body reaches PC board surface.
- j) Do not apply any mechanical force in excess of the limits prescribed in the catalogs or the product specifications of the capacitors. Also, note the capacitors may be damaged by mechanical shocks caused by the vacuum/insertion head, component checker or centering operation of an automatic mounting or insertion machine.

2. Soldering and Solderability

- a) When soldering with a soldering iron
 - Soldering conditions (temperature and time) should be within the limits prescribed in the catalogs or the product specifications.
 - If the terminal spacing of a capacitor does not fit the terminal hole spacing of the PC board, reform the terminals in a manner to minimize a mechanical stress into the body of the capacitor.
 - Remove the capacitors from the PC board , after the solder is completely melted, reworking by using a soldering iron minimizes the mechanical stress to the capacitors.
 - Do not touch the capacitor body with the hot tip of the soldering iron.
- b) Flow soldering
 - Do not dip the body of a capacitor into the solder bath, only dip the terminals in. The soldering must be done on the reverse side of PC board.
 - Soldering conditions (preheat, solder temperature and dipping time) should be within the limits prescribed in the catalogs or the product specifications.
 - Do not apply flux to any part of capacitors other than their terminals.
 - Make sure the capacitors do not come into contact with any other components while soldering.
- c) Reflow soldering (only applicable for SMD type)
 - Soldering conditions (preheat, solder temperature and dipping time) should be within the limits prescribed in the catalogs or the product specifications.
 - When setting the temperature infrared heaters, consider that the infrared absorption causes material to be discolored and change in appearance.
 - Do not solder capacitors more than once using reflow. If it should be done for twice, please consult us first.
 - Make sure capacitors do not come into contact with copper traces.
- d) Do not re-use surface mount capacitors which have already been soldered. In addition, when installing a new capacitor onto the assembly board to rework, remove old residual flux from the surface of the PC board, and then use a soldering iron within the prescribed conditions.
- e) Confirm whether reflow soldering is applicable for the capacitors.

3. Handling after soldering

- Do not apply any mechanical stress to the capacitor after soldering onto the PC board.
- a) Do not lean or twist the body of the capacitor after soldering the capacitors onto the PC board.
- b) Do not use the capacitors for lifting or carrying the assembly board.
- c) Do not hit or poke the capacitor after soldering to PC board. When stacking the assembly board, be careful that other components do not touch the aluminum electrolytic capacitors.
- d) Do not drop the assembly board.

4. Cleaning PC board

- a) Do not wash capacitors by using the following cleaning agents.
 - Halogenated solvents: cause capacitors to fail due to corrosion.
 - Alkali system solvents: corrode (dissolve) an aluminum case.
 - Petroleum and terpene system solvents: cause the rubber seal material to deteriorate.
 - Xylene: cause the rubber seal material to deteriorate.
 - Acetone: erase the marking. Solvent-proof capacitors are only suitable for washing within the cleaning conditions prescribed in the catalogs or the product specifications. In particular, ultrasonic cleaning will accelerate damaging capacitors.

- b) Verify the following points when washing capacitors.
- Monitor conductivity, pH, specific gravity, and the water content of cleaning agents. Contamination adversely affects these characteristics.
 - Be sure not to keep the capacitors in an atmosphere containing the cleaning agent or in an air tight container.
- In addition, please dry the solvent sufficiently on the PC board and the capacitor with an air knife (temperature should be less than the maximum rated category temperature of the capacitor) over 10 minutes. Aluminum electrolytic capacitors can be characteristically and catastrophically damaged by halogen ions, particularly by chlorine ions, though the degree of the damage mainly depends upon the characteristics of the electrolyte and rubber seal material. When halogen ions come into contact with the capacitors, the foil corrodes when voltage is applied. This corrosion causes extremely high leakage current, which in turn, causes venting and an open circuit.

5. Precautions for using adhesives and coating

- a) Do not use any adhesive and coating materials containing halogenated solvent.
- b) Verify the following before using adhesive and coating material.
- Remove flux and dust leftover between the rubber seal and the PC board before applying adhesive or coating materials to the capacitor.
 - Dry and remove any residual cleaning agents before applying adhesive and coating materials to the capacitors. Do not cover over the whole surface of the rubber seal with the adhesive or coating materials.
 - For permissible heat conditions for curing adhesives or coating materials, follow the instructions in the catalogs or the product specifications of the capacitors.
 - Covering over the whole surface of the capacitor rubber seal with resin may result in a hazardous condition because the inside pressure cannot be released completely. Also, a large amount of halogen ions in resins will cause the capacitors to fail because the halogen ions penetrate into the rubber seal and the inside of the capacitor.
- c) Some of coating material cannot be cured over the capacitor. Please note that loose luster and whitening on the surface of the outer sleeve might be caused according to the kind of solvents used for mounting adhesives and coating agents.

6. Fumigation

In many cases when exporting or importing electronic devices, such as capacitors, wooden packaging is used. In order to control insects, most often, it becomes necessary to fumigate the shipments. Precautions during "Fumigation" using halogenated chemical such as Methyl Bromide must be taken. Halogen gas can penetrate packaging materials used, such as, cardboard boxes and vinyl bags. Penetration of the halogenated gas can cause corrosion of electrolytic capacitors.

The Operation of Devices

- a) Do not touch a capacitor directly with bare hands.
- b) Do not short-circuit the terminal of a capacitor by letting it come into contact with any conductive object. Also, do not spill conductive liquid such as acid or alkaline solution over the capacitor.
- c) Do not use capacitors in circumstance where they would be subject to exposure to the following materials:
- Oil, water, salty water or damp location.
 - Direct sunlight.
 - Toxic gases such as hydrogen sulfide, sulfurous acid, nitrous acid,

chlorine or its compounds, and ammonium.

- Ozone, ultraviolet rays or radiation.
- Severe vibration or mechanical shock conditions beyond the limits prescribed in the catalogs or product specification.

Maintenance Inspection

- a) Make periodic inspections of capacitors that have been used in industrial applications. Before inspection, turn off the power supply and carefully discharge the electricity in the capacitors. Verify the polarity when measuring the capacitors with a volt-ohm meter. Also, do not apply any mechanical stress to the terminals of the capacitors.
- b) The following items should be checked during the periodic inspections.
- Significant damage in appearance: venting and electrolyte leakage.
 - Electrical characteristics: leakage current, capacitance, tan and other characteristics prescribed in the catalog or product specifications. We recommend replacing the capacitors if the parts are out of specification.

In Case of Venting

- a) If a non-solid aluminum electrolytic capacitor expels gas when venting, it will discharge odors or smoke, or burn in the case of a short-circuit failure. Immediately turn off or unplug the main power supply of the device.
- b) When venting, a non-solid aluminum electrolytic capacitor blows out gas with a temperature of over 100°C. (A solid aluminum electrolytic capacitor discharges decomposition gas or burning gas while the outer resin case is burning.) Never expose the face close to a venting capacitor.

If your eyes inadvertently become exposed to the spouting gas or you inhale it, immediately flush the open eyes with large amounts of water and gargle with water respectively. If electrolyte is on the skin, wash the electrolyte away from the skin with soap and plenty of water. Do not lick the electrolyte of non-solid aluminum electrolytic capacitors.

Storage

We recommend the following conditions for storage.

- a) Do not store capacitors at a high temperature or in high humidity. Store the capacitors indoors at a temperature of 5 to 35°C and a relative humidity of 75% or below.
- b) Store the capacitors in places free from water, oil or salt water.
- c) Store the capacitors in places free from toxic gases (hydrogen sulfide, sulfurous acid, chlorine, ammonium, etc.)
- d) Store the capacitors in places free from ozone, ultraviolet rays or radiation.
- e) Keep capacitors in the original package.

Disposal

Please consult with a local industrial waste disposal specialist when disposing aluminum electrolytic capacitors.

Catalog

Specifications in the catalog may be subject to change without notice. Please consult us first before use. Hunan Aihua Group reserves the right of final interpretation of all the content.

Soldering Recommendation

■ Flow Soldering(Radial Lead Type)

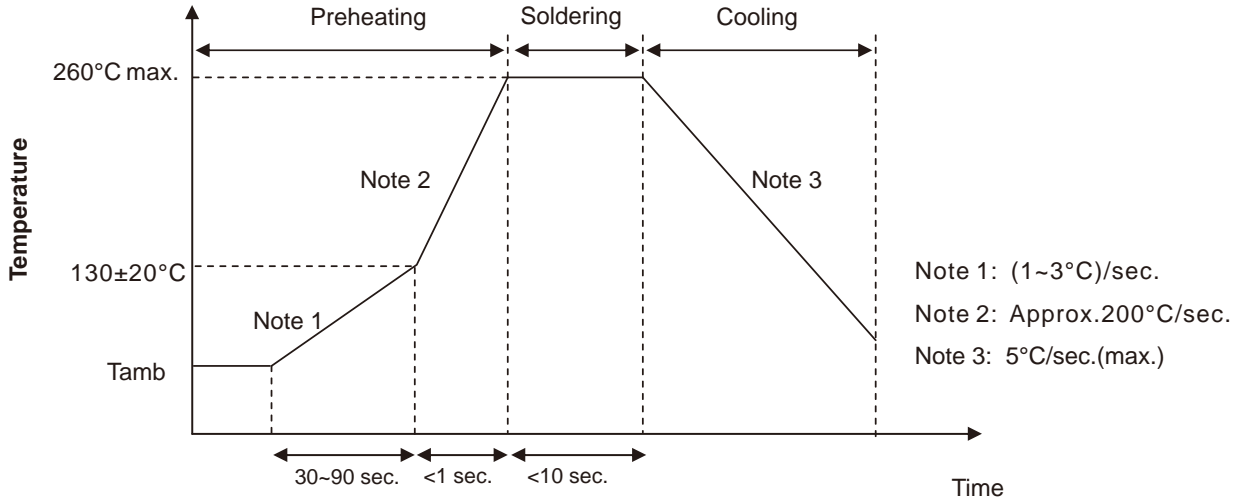

■ Reflow Soldering

- (For Polymer SMD Type)

Recommended Reflow Profile

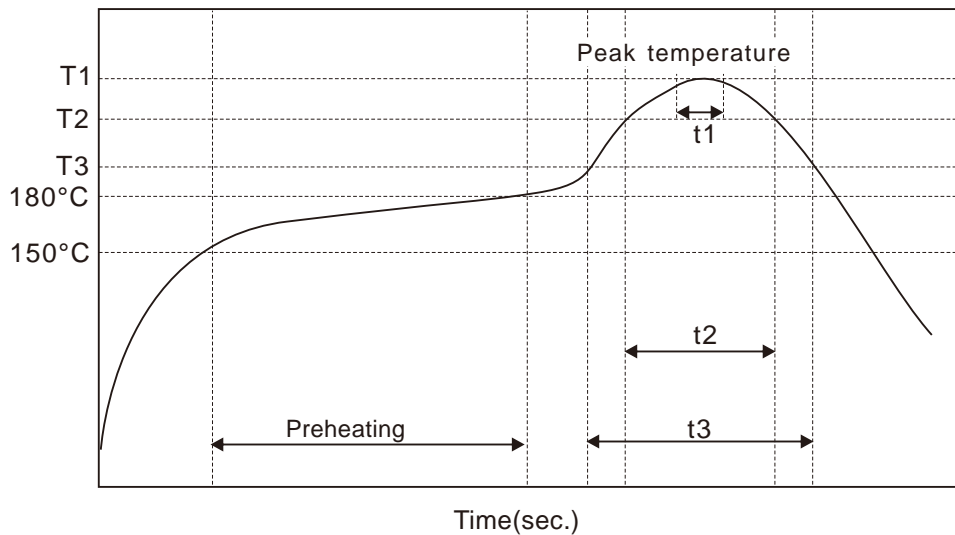

Item	Preheating	T1(°C)	T2(°C)	T3(°C)	t1(sec.)	t2(sec.)	t3(sec.)	Reflow cycle
Condition 1	150°C to 180°C Within 90sec.	260	230	200	10	40	60	1
Condition 2		250	230	200	10	40	60	2

• (For Liquid SMD Type)

Case size: 6.3~ 10mm:

- Temperature at surface of capacitor shall not exceed T°C.
- The duration for over 200°C temperature and T₁°C at surface of capacitor shall not exceed t and t₁ seconds, respectively.
- Preheat shall be done at 100°C to 200°C and for Maximum 180 seconds.

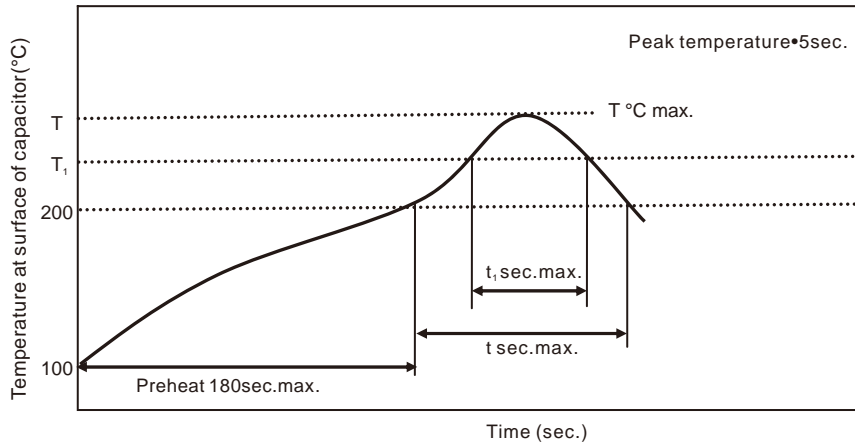

Case size (mm)	T(°C)	T ₁ (°C)	t(sec.)	t ₁ (sec.)	Reflow cycle
6.3	250	230	90	40	1
8	240	230	90	30	1
10	240	230	60	30	1

Peak temperature
The duration over 200°C (max.)
The duration over T₁°C

- Please contact us if capacitors are subject to the conditions other than the allowable range of reflow.

Case size: 12.5~ 18mm:

- Temperature at surface of capacitor shall not exceed T°C.
- The duration for over 200°C temperature and T₁°C at surface of capacitor shall not exceed t and t₁ seconds, respectively.
- Preheat shall be done at 100°C to 180°C and for Maximum 150 seconds.

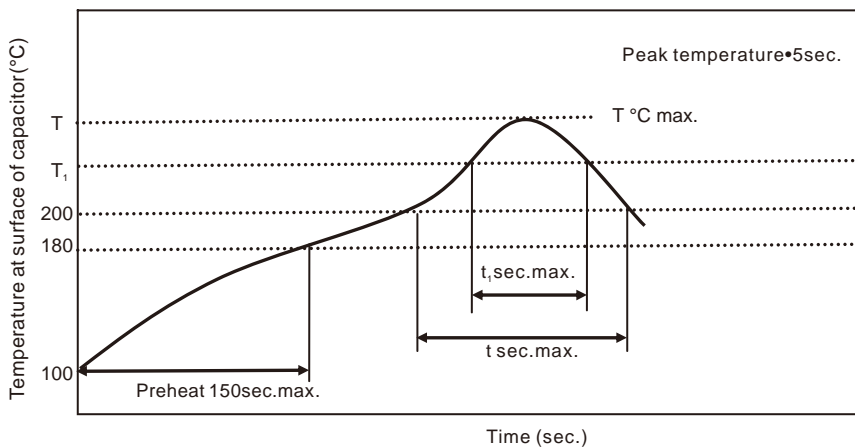

Case size (mm)	Rated Voltage (Vdc)	T(°C)	T ₁ (°C)	t(sec.)	t ₁ (sec.)	Reflow cycle
12.5~ 18	100	240	230	60	30	1
	120	230	220	60	30	

Peak temperature
The duration over 200°C (max.)
The duration over T₁°C

- Please contact us if capacitors are subject to the conditions other than the allowable range of reflow.

Part Numbering System

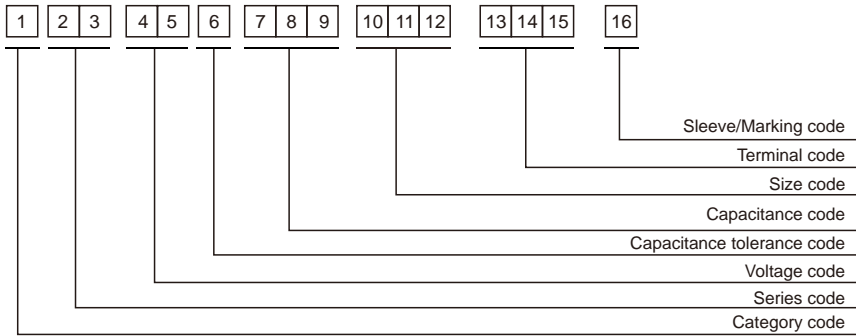

Category code

Type	Code
	1
Aluminum electrolytic capacitor	E

Voltage code

WV (V _{dc})	Code	
	4	5
2.5	0	E
3	0	D
4	0	G
6.3	0	J
6.8	0	C
7	0	Q
7.5	0	A
10	1	A
12	1	T
16	1	C
25	1	E
35	1	V
40	1	G
50	1	H
63	1	J
80	1	B
100	1	K
120	2	B
160	2	C
180	2	L
200	2	D
220	2	N
250	2	E
315	2	F
350	2	V
380	2	P
400	2	G
420	2	T
450	2	W
500	2	H
550	2	J
600	2	K

Capacitance tolerance code

Tol. (%)	Code
	6
-10~+10	K
-20~+20	M
-10~+30	Q
-10~+20	V
0~+20	A
-5~+20	C
-10~-20	B
-5~-+5	D
0~+10	E
-5~-20	F
-15~-+5	N

Capacitance code

Cap (μF)	Code		
	7	8	9
0.10	R	1	0
0.22	R	2	2
0.33	R	3	3
0.47	R	4	7
0.68	R	6	8
1	0	1	0
2.2	2	R	2
3.3	3	R	3
4.7	4	R	7
6.8	6	R	8
10	1	0	0
22	2	2	0
33	3	3	0
47	4	7	0
68	6	8	0
100	1	0	1
220	2	2	1
330	3	3	1
470	4	7	1
680	6	8	1
1000	1	0	2
2200	2	2	2
3300	3	3	2
4700	4	7	2
6800	6	8	2
10000	1	0	3
22000	2	2	3
33000	3	3	3
68000	6	8	3

Series code

Series name	Code	
	2	3
WH	W	H
CD11GE	G	E
CD11GES	G	X
CD11GAS	G	W
CD11GHS	G	S
NR	N	R

Size code

D (mm)	Code	L (mm)	Code	
	10		11	12
4	C	5	0	5
5	D	7	0	7
6.3	E	11	1	1
8	F	12	1	2
10	G	16	1	6
11	H	20	2	0
12	J	25	2	5
12.5	W	30	3	0
13	K	35	3	5
14	X	40	4	0
16	L	46	4	6
18	M	50	5	0
19	Z	60	6	0
20	N	80	8	0
22	O	100	A	0
25	P	115	B	5
30	Q	120	C	0
35	R	130	D	0
40	Y	140	E	0
51.6	S	160	G	0
64.3	T	200	K	0
76.9	U	220	M	0
91	V	236	N	6
100	A	250	P	0

Terminal code

Specification	Code	Size	
	13	14	15
Bulk packing	O	-	-
Taping (SMD Type)	D	0	0
4~8 Taping F=5.0mm	P	5	0
10~12.5 Taping F=5.0mm	B	5	0
Lead Cut L=3.5mm	C	3	5
Lead Cut L=11.0mm	C	B	0
Lead Forming & Cut L=4.5mm	F	-	-
Kink & Cut L=4.5mm	J	-	-
Snap-in type Terminal 4.0mm in length	K	-	-
Three Terminals	T	-	-
Ring clip mounting standard design	A	0	0
Ring clip mounting special design	S	-	-

Sleeve/Marking code

Sleeve/Marking	Code
	16
PVC	C
PET	T
Dark blue	B
Bright red	R
Sky-blue	S
Light blue	T
Pink	Z
Black	H
Purple-blue	V
Red	O

Part Numbering System(Conductive polymer solid & hybrid capacitors)

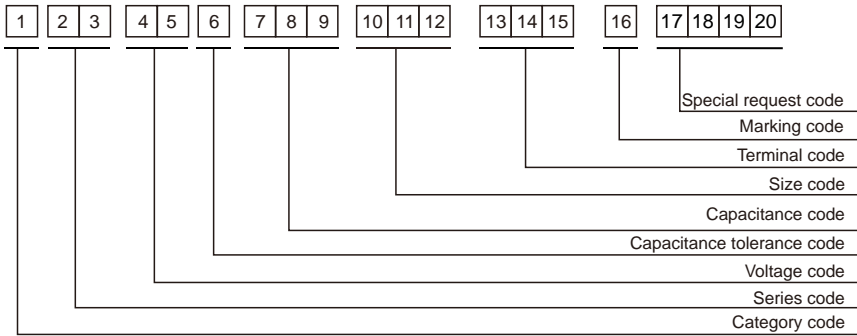

Category code

Type	Code
	1
Conductive polymer aluminum solid capacitor	S
Conductive polymer hybrid aluminum electrolytic capacitor	H

Voltage code

WV (V _{dc})	Code	
	4	5
2	0	B
2.5	0	E
3	0	D
4	0	G
6.3	0	J
6.5	0	F
6.8	0	C
7	0	Q
7.5	0	A
10	1	A
12	1	T
14	1	L
16	1	C
18	1	Q
20	1	D
22	1	I
25	1	E
30	1	S
32	1	F
35	1	V
38	1	N
40	1	G
50	1	H
63	1	J
80	1	B
100	1	K
160	2	C
180	2	L
200	2	D
220	2	N
250	2	E
315	2	F

Capacitance tolerance code

Tol. (%)	Code
-10~+10	K
-20~+20	M
-10~+30	Q
-10~+50	T
-10~+20	V
-8~+20	H
0~+20	A
0~+30	
-5~+20	C
+6~+20	J
+6~+30	O
-10~-20	B
-5~+5	D
-0~+10	E
-5~-20	F
-15~+5	N
-15~+15	W
-15~+20	G
-35~+10	L
+4~+30	I

Capacitance code

Cap (μF)	Code		
	7	8	9
0.10	R	1	0
0.22	R	2	2
1	0	1	0
2.2	2	R	2
9.8	6	R	8
10	1	0	0
22	2	2	0
33	3	3	0
47	4	7	0
56	5	6	0
68	6	8	0
100	1	0	1
150	1	5	1
180	1	8	1
220	2	2	1
270	2	7	1
470	4	7	1
560	5	6	1
680	6	8	1
820	8	2	1
1000	1	0	2
1200	1	2	2
2200	2	2	2
3300	3	3	2

Series code

Series	Code		
	2	3	
Radial Type	PR	P	R
	PZ	P	Z
	PU	P	U
	PD	P	D
	PH	P	H
	PT	P	T
	PK	P	K
	PV	P	V
SMD type	PF	P	F
	VS	V	S
	VZ	V	Z
	VD	V	D
VT	V	T	

Size code

D (mm)	Code
4	10
4.5	C
5	A
5.5	D
6.3	B
6.8	E
7	Q
8	R
10	F
11	G
12	H
12.5	J
13	W
14	K
16	X
18	L
19	M
20	Z
	N

L (mm)	Code	
	11	12
5	0	5
7	0	7
7.5	7	R
8	0	8
9	0	9
10	1	0
11	1	1
12	1	2
16	1	6
20	2	0
25	2	5
10.5	A	R
11.5	B	R
12.5	C	R

Terminal code

Specification	Code			Specification	Code		
	13	14	15		13	14	15
Bulk packing (standard lead pitch)	O	0	0	Base plate(SMD type)	D	0	0
Bulk packing (special lead pitch)	O	-	-	Taping(SMD type)	E	0	0

Marking code

MARKING	Code
	16
Dark blue	B
Baby blue	L
Bright red	R
Sky-blue	S
Black	H
Purple-blue sleeve	V
Red sleeve	O
Black sleeve	A

Lead Forming

Taping Specifications (Unit: mm)

Fig.1 code: X

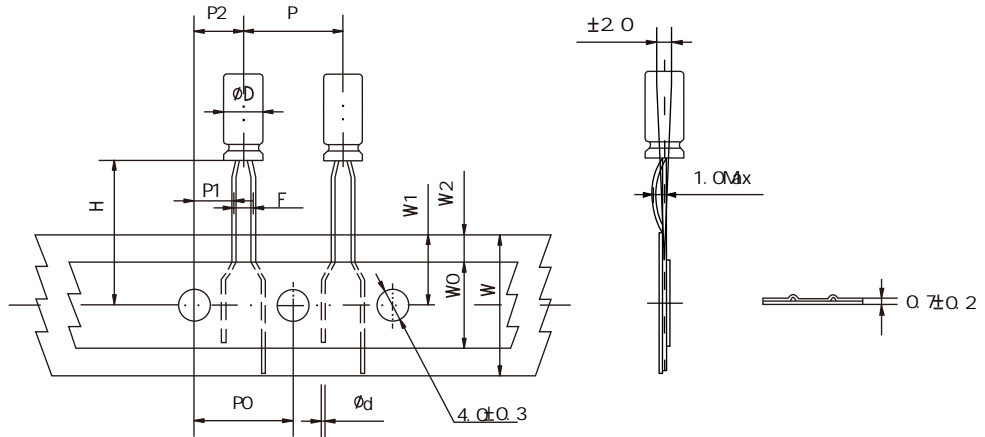

Fig.2 code: B

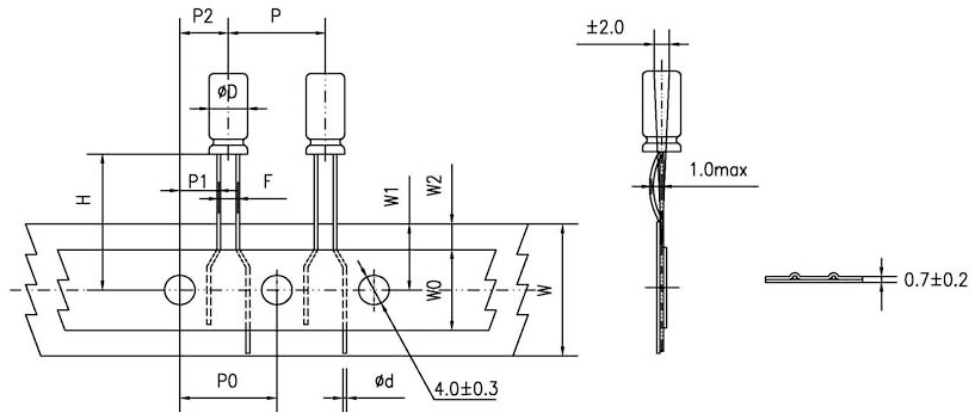

Fig.3 code: B

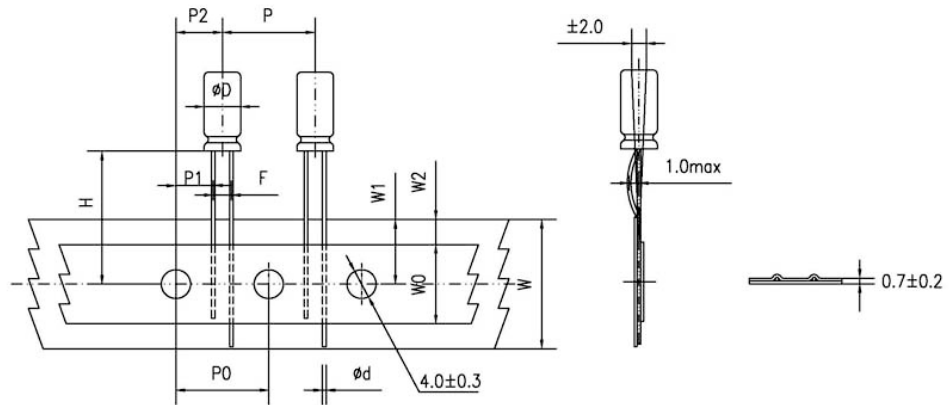
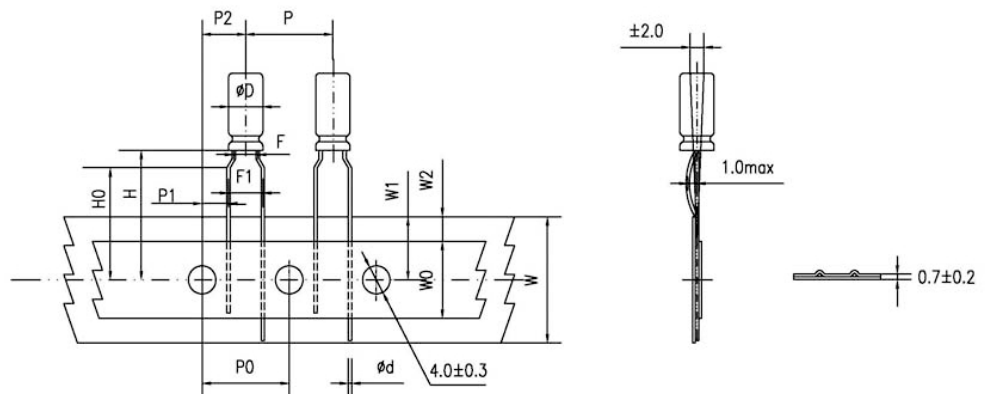

Fig.4 code: P



Lead Forming

Specification Fig.1 & Fig.2 & Fig.3

(mm)

Items	Symbol	Case size										Tolerance		
		4x5 4x7		5x5 5x7		5x11		6.3x5	6.3x7 6.3x9 6.3x11 6.3x12	8x5/7 8x9/11 8x11.5 8x12	8x16 8x20		10x9 10x12 10x13/16 10x20/25	12.5x16 12.5x20 13x20
Pin Code		X	B	X	B	X	B	B	B	B	B	B	B	
Lead wire diameter	d	0.45		0.45		0.5		0.45	0.5	0.45/0.5	0.6	0.6	0.6	±0.05
Pitch of body	P	12.7		12.7		12.7		12.7	12.7	12.7	12.7	12.7	15	±1.0
Feed hole pitch	P0	12.7		12.7		12.7		12.7	12.7	12.7	12.7	12.7	15	±0.2
Distance from hole center to lead	P1	5.1	5.6	5.1	5.35	5.1	5.35	5.1	5.1	4.6	4.6	3.85	5.0	±0.7
Distance from feed hole center to body center	P2	6.35		6.35		6.35		6.35	6.35	6.35	6.35	6.35	7.5	±1.0
Lead-to-lead distance	F	2.5	1.5	2.5	2.0	2.5	2.0	2.5	2.5	3.5	3.5	5.0	5.0	±0.5
Height of body from tape center	H	18.5		18.5		18.5		18.5	18.5	18.5	18.5	18.5	18.5	±0.75
Base tape width	W	18.0		18.0		18.0		18.0	18.0	18.0	18.0	18.0	18.0	±0.5
Adhesive tape width	W0	6.0		6.0		6.0		6.0	8.0	8.0	8.0	11.0	11.0	min
Hole position	W1	9.0		9.0		9.0		9.0	9.0	9.0	9.0	9.0	9.0	+0.75 -0.5
Hole down tape position	W2	1.5		1.5		1.5		1.5	1.5	1.5	1.5	1.5	1.5	max

Specification Fig.4

(mm)

Items	Symbol	Case size									Tolerance
		4x5 4x7	5x5	5x7	5x11	6.3x5	6.3x7 6.3x9	6.3x11 6.3x12	8x5/7 8x9/11 8x11.5/12	8x16 8x20	
Pin Code		P	P	P	P	P	P	P	P	P	
Lead wire diameter	d	0.45	0.45	0.45	0.5	0.45	0.5	0.5	0.45/0.5	0.6	±0.05
Pitch of body	P	12.7	12.7	12.7	12.7	12.7	12.7	12.7	12.7	12.7	±1.0
Feed hole pitch	P0	12.7	12.7	12.7	12.7	12.7	12.7	12.7	12.7	12.7	±0.2
Distance from hole center to lead	P1	3.85	3.85	3.85	3.85	3.85	3.85	3.85	3.85	3.85	±0.7
Distance from feed hole center to body center	P2	6.35	6.35	6.35	6.35	6.35	6.35	6.35	6.35	6.35	±1.0
Lead-to-lead distance	F	1.5	2.0	2.0	2.0	2.5	2.5	2.5	3.5	3.5	±0.5
Lead to lead distance	F1	5.0	5.0	5.0	5.0	5.0	5.0	5.0	5.0	5.0	+0.8 -0.2
Height of body from tape center	H	18.5	18.5	18.5	18.5	18.5	18.5	18.5	18.5	18.5	±0.75
Lead wire clinch height	H0	16.0	16.0	16.0	16.0	16.0	16.0	16.0	16.0	16.0	±0.5
Base tape width	W	18.0	18.0	18.0	18.0	18.0	18.0	18.0	18.0	18.0	±0.5
Adhesive tape width	W0	6.0	6.0	6.0	6.0	6.0	6.0	8.0	8.0	8.0	min
Hole position	W1	9.0	9.0	9.0	9.0	9.0	9.0	9.0	9.0	9.0	+0.75 -0.5
Hole down tape position	W2	1.5	1.5	1.5	1.5	1.5	1.5	1.5	1.5	1.5	max

Lead Forming
Lead Forming & Cut

Code:C
RANGE: 4~ 18

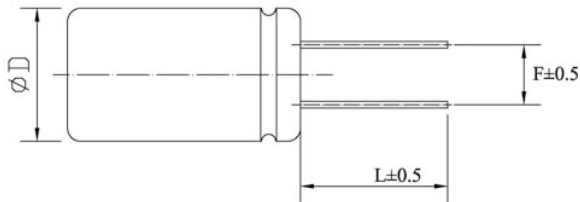

Code:F
RANGE: 4~ 8

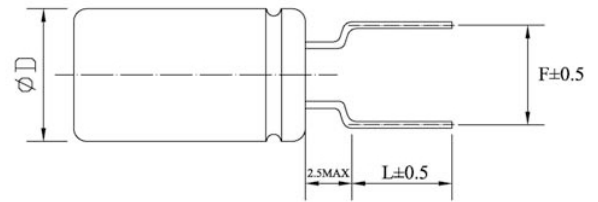

(mm)

D	F	L	D	F	L
4	1.5	3.0~12.0	4	5.0	3.5, 4.5, 5.0, 7.0
5	2.0	3.0~12.0	5	5.0	3.5, 4.5, 5.0, 7.0
6.3	2.5	3.0~12.0	6.3	5.0	3.5, 4.5, 5.0, 7.0
8	3.5	3.0~12.0	8	5.0	3.5, 4.5, 5.0, 7.0
10	5.0	3.0~12.0	-	-	-
12.5	5.0	3.0~12.0	-	-	-
16	7.5	3.0~12.0	-	-	-
18	7.5	3.0~12.0	-	-	-

Code:R/L
RANGE: 10~ 18

Right horizontal forming

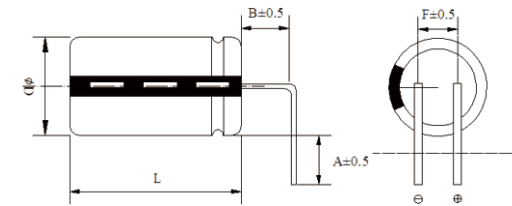

Left horizontal forming

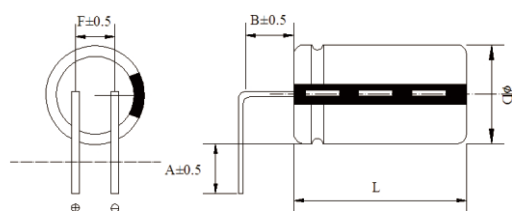

(mm)

D	F	A	B
10~12.5	5.0	2.5, 3.0, 3.5, 4.0, 4.5, 5.0	1.5, 2.5
16~18	7.5	2.5, 3.0, 3.5, 4.0, 4.5, 5.0	1.5, 2.5

A1 series

- Endurance: 2,000 hours at 105°C
- Low ESR
- Recommended Applications: System Board, Display Card, Small Charger and intelligent TV
- **RoHS Compliant and lead-free**

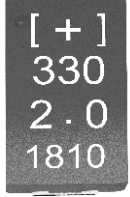

SPECIFICATIONS

Items	Characteristics										
Category Temperature Range	-55~+105°C										
Rated Working Voltage Range	2~25 Vdc										
Nominal Capacitance Range	6.8~470μF										
Capacitance Tolerance	±20%(M) (at 20°C, 120Hz)										
DC Leakage Current	I 0.1CV W.V.:2V~25V Where, I: Leakage current (μA), C:Nominal capacitance (μF), V: Rated voltage (V) (at 20°C after 2 minutes)										
Dissipation Factor (tan)	Rated Voltage(Vdc)	2	2.5	4	6.3	7.5	10	12.5	16	25	(at 20°C, 120Hz)
	tan (max.)	0.06								0.10	
ESR(100k~300kHz,20°C)	Value in characteristics table										
Temperature Characteristic (Impedance Ratio at 100kHz)	Z(+105°C)/Z(+20°C) 1.25 Z(-55°C)/Z(+20°C) 1.25										
Endurance	After applying rated voltage with rated ripple current for 2,000 hours at 105°C, the capacitors shall meet the following requirements.										
	Appearance	No significant damage									
	Capacitance Change	±20% of the initial value									
	D.F. (tan)	150% of the initial specified value									
	Leakage Current	The initial specified value									
Humidity Test	After subjecting to 90%~95% RH for 500 hours at 60°C(no voltage), the capacitors shall meet the requirement as Endurance.										
	Rated Voltage(Vdc)	2~2.5		4		6.3~7.5		8~16		25	
	Capacitance Change	+70,-20%		+60,-20%		+50,-20%		+40,-20%			
	D.F. (tan)	200% of the initial specified value									
	Leakage Current	The initial specified value									
Surge Test	After subjecting to 1,000 cycles each consisting of charge with the surge voltage specified at normal temperature for 30 seconds through a protective resistor and discharge for 5 minutes 30 seconds, the capacitors shall meet the following requirements.										
	Appearance	No significant damage									
	Capacitance Change	±20% of the initial value									
	D.F. (tan)	150% of the initial specified value									
	Leakage Current	The initial specified value									

DIMENSIONS[mm]

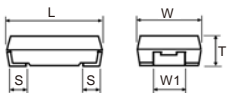

Case Size	L±0.3(mm)	W±0.2(mm)	T±0.1(mm)	W1±0.2(mm)	S±0.2(mm)
7.3x4.3x1.9	7.3	4.3	1.9	2.4	1.3

MARKING



PART NUMBERING SYSTEM

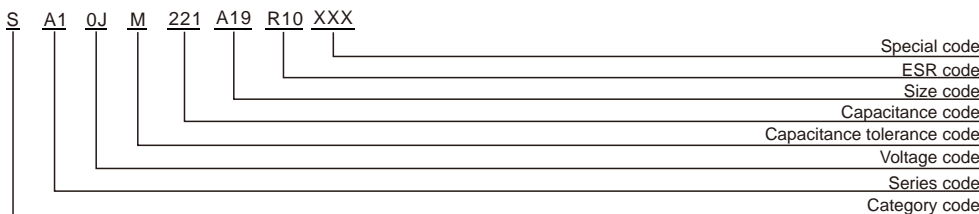

A1 series

■ STANDARD RATINGS

VDC (SV)	Cap (μF)	Size (LxWxT mm)	ESR (mΩ, 20°C, 100kHz) (max.)	Rated ripple current (100kHz, 20~105°C)(mA rms)	Leakage Current (20°C) (μA max.)	Part Number
2 (2.3)	100	7.3x4.3x1.9	16	2000	20.0	SA10BM101A19R16XXX
	150	7.3x4.3x1.9	9	3000	30.0	SA10BM151A19R09XXX
	220	7.3x4.3x1.9	9	3000	44.0	SA10BM221A19R09XXX
	270	7.3x4.3x1.9	9	3500	54.0	SA10BM271A19R09XXX
	330	7.3x4.3x1.9	7	3500	66.0	SA10BM331A19R07XXX
		7.3x4.3x1.9	9	3500	66.0	SA10BM331A19R09XXX
	470	7.3x4.3x1.9	4.5	3500	94.0	SA10BM471A19R04XXX
		7.3x4.3x1.9	6	3500	94.0	SA10BM471A19R06XXX
7.3x4.3x1.9		9	3500	94.0	SA10BM471A19R09XXX	
2.5 (2.5)	100	7.3x4.3x1.9	16	2000	25.0	SA10EM101A19R16XXX
	150	7.3x4.3x1.9	9	3000	37.5	SA10EM151A19R09XXX
	220	7.3x4.3x1.9	9	3000	55.0	SA10EM221A19R09XXX
	270	7.3x4.3x1.9	9	3500	67.5	SA10EM271A19R09XXX
	330	7.3x4.3x1.9	9	3500	82.5	SA10EM331A19R09XXX
4 (4.6)	68	7.3x4.3x1.9	20	1900	27.2	SA10GM680A19R20XXX
	82	7.3x4.3x1.9	16	2100	32.8	SA10GM820A19R16XXX
	150	7.3x4.3x1.9	16	2100	60.0	SA10GM151A19R16XXX
6.3 (7.2)	10	7.3x4.3x1.9	55	1000	6.3	SA10JM100A19R55XXX
	22	7.3x4.3x1.9	80	1000	13.9	SA10JM220A19R80XXX
	33	7.3x4.3x1.9	80	1800	20.8	SA10JM330A19R80XXX
	47	7.3x4.3x1.9	35	1800	29.6	SA10JM470A19R35XXX
	68	7.3x4.3x1.9	15	2000	42.8	SA10JM680A19R15XXX
	100	7.3x4.3x1.9	15	2000	63.0	SA10JM101A19R15XXX
	150	7.3x4.3x1.9	10	3000	94.5	SA10JM151A19R10XXX
		7.3x4.3x1.9	15	3000	94.5	SA10JM151A19R15XXX
220	7.3x4.3x1.9	10	3000	138.6	SA10JM221A19R10XXX	
	7.3x4.3x1.9	15	3000	138.6	SA10JM221A19R15XXX	
7.5 (8.6)	150	7.3x4.3x1.9	10	3000	112.5	SA10AM151A19R10XXX
	200	7.3x4.3x1.9	12	3000	150.0	SA10AM201A19R12XXX
10 (11.5)	10	7.3x4.3x1.9	55	1000	10.0	SA11AM100A19R55XXX
	22	7.3x4.3x1.9	120	1600	22	SA11AM220A19RA2XXX
	33	7.3x4.3x1.9	25	1800	33	SA11AM330A19R25XXX
	100	7.3x4.3x1.9	15	2500	100.0	SA11AM101A19R15XXX
12.5 (14.4)	10	7.3x4.3x1.9	55	1000	12.5	SA11TM100A19R55XXX
	15	7.3x4.3x1.9	45	1000	18.8	SA11TM150A19R45XXX
	22	7.3x4.3x1.9	30	1600	27.5	SA11TM220A19R30XXX
	33	7.3x4.3x1.9	25	1800	41.3	SA11TM330A19R25XXX
	47	7.3x4.3x1.9	20	2000	58.8	SA11TM470A19R20XXX
	56	7.3x4.3x1.9	15	2000	70.0	SA11TM560A19R15XXX
	100	7.3x4.3x1.9	12	2500	125.0	SA11TM101A19R12XXX
16 (18.4)	6.8	7.3x4.3x1.9	70	1000	10.9	SA11CM6R8A19R70XXX
	10	7.3x4.3x1.9	60	1000	16.0	SA11CM100A19R60XXX
	15	7.3x4.3x1.9	40	1000	24.0	SA11CM150A19R40XXX
	47	7.3x4.3x1.9	55	1400	75.2	SA11CM470A19R55XXX
	68	7.3x4.3x1.9	30	1600	108.8	SA11CM680A19R30XXX
25 (28.8)	10	7.3x4.3x1.9	35	1000	25.0	SA11EM100A19R35XXX
	33	7.3x4.3x1.9	60	1400	82.5	SA11EM330A19R60XXX

Conductive Polymer Multilayer Type

Specifications may be subject to change without notice.

A2 series

- Endurance: 2,000 hours at 105°C
- Low ESR
- Recommended Applications: System Board, Display Card, Small Charger and intelligent TV
- **RoHS Compliant and lead-free**

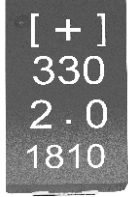

SPECIFICATIONS

Items	Characteristics										
Category Temperature Range	-55~+105°C										
Rated Working Voltage Range	2~25 V _{dc}										
Nominal Capacitance Range	6.8~470μF										
Capacitance Tolerance	±20%(M) (at 20°C,120Hz)										
DC Leakage Current	I 0.1CV W.V.:2V~25V Where, I: Leakage current (μA), C:Nominal capacitance (μF), V: Rated voltage (V) (at 20°C after 2 minutes)										
Dissipation Factor (tan δ)	Rated Voltage(V _{dc})	2	2.5	4	6.3	7.5	10	12.5	16	25	0.10 (at 20°C,120Hz)
	tan δ (max.)	0.06									
ESR(100k~300kHz,20°C)	Value in characteristics table										
Temperature Characteristic (Impedance Ratio at 100kHz)	Z(+105°C)/Z(+20°C) 1.25 Z(-55°C)/Z(+20°C) 1.25										
Endurance	After applying rated voltage with rated ripple current for 2,000 hours at 105°C, the capacitors shall meet the following requirements.										
	Appearance	No significant damage									
	Capacitance Change	±20% of the initial value									
	D.F. (tan δ)	150% of the initial specified value									
	Leakage Current	The initial specified value									
Humidity Test	After subjecting to 90%-95% RH for 500 hours at 60°C(no voltage), the capacitors shall meet the requirement as Endurance.										
	Rated Voltage(V _{dc})	2~2.5		4		6.3~7.5		8~16		25	
	Capacitance Change	+70,-20%		+60,-20%		+50,-20%		+40,-20%			
	D.F. (tan δ)	200% of the initial specified value									
	Leakage Current	The initial specified value									
Surge Test	After subjecting to 1,000 cycles each consisting of charge with the surge voltage specified at normal temperature for 30 seconds through a protective resistor and discharge for 5 minutes 30 seconds, the capacitors shall meet the following requirements.										
	Appearance	No significant damage									
	Capacitance Change	±20% of the initial value									
	D.F. (tan δ)	150% of the initial specified value									
	Leakage Current	The initial specified value									

DIMENSIONS[mm]

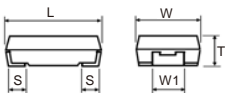

Case Size	L±0.3(mm)	W±0.2(mm)	T±0.1(mm)	W1±0.2(mm)	S±0.2(mm)
7.3x4.3x2.8	7.3	4.3	2.8	2.4	1.3

MARKING



PART NUMBERING SYSTEM

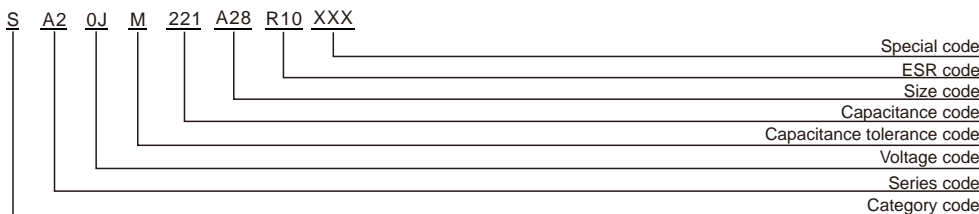

A2 series

■ STANDARD RATINGS

VDC (SV)	Cap (μF)	Size (LxWxT mm)	ESR (mΩ, 20°C, 100kHz) (max.)	Rated ripple current (100kHz, 20~105°C)(mA rms)	Leakage Current (20°C) (μA max.)	Part Number
2 (2.3)	100	7.3x4.3x2.8	16	2000	20	SA20BM101A28R16XXX
	150	7.3x4.3x2.8	9	3000	30	SA20BM151A28R09XXX
	220	7.3x4.3x2.8	9	3000	44	SA20BM221A28R09XXX
	270	7.3x4.3x2.8	9	3500	54	SA20BM271A28R09XXX
	330	7.3x4.3x2.8	9	3500	66	SA20BM331A28R09XXX
	470	7.3x4.3x2.8	9	3500	94	SA20BM471A28R09XXX
2.5 (2.5)	100	7.3x4.3x2.8	16	2000	25	SA20EM101A28R16XXX
	150	7.3x4.3x2.8	9	3000	37.5	SA20EM151A28R09XXX
	180	7.3x4.3x2.8	12	2500	45	SA20EM181A28R12XXX
	220	7.3x4.3x2.8	9	3000	55	SA20EM221A28R09XXX
	270	7.3x4.3x2.8	9	3500	67.5	SA20EM271A28R09XXX
	330	7.3x4.3x2.8	7	3500	82.5	SA20EM331A28R07XXX
		7.3x4.3x2.8	9	3500	82.5	SA20EM331A28R09XXX
		7.3x4.3x2.8	4.5	3500	117.5	SA20EM471A28R04XXX
	470	7.3x4.3x2.8	6	3500	117.5	SA20EM471A28R06XXX
7.3x4.3x2.8		9	3500	117.5	SA20EM471A28R09XXX	
4 (4.6)	68	7.3x4.3x2.8	20	1900	27.2	SA20GM680A28R20XXX
	82	7.3x4.3x2.8	16	2100	32.8	SA20GM820A28R16XXX
	150	7.3x4.3x2.8	18	2100	60	SA20GM151A28R18XXX
6.3 (7.2)	10	7.3x4.3x2.8	55	1000	6.3	SA20JM100A28R55XXX
	22	7.3x4.3x2.8	45	1000	13.9	SA20JM220A28R45XXX
	33	7.3x4.3x2.8	25	1800	20.8	SA20JM330A28R25XXX
	47	7.3x4.3x2.8	25	1800	29.6	SA20JM470A28R25XXX
	68	7.3x4.3x2.8	15	2000	42.8	SA20JM680A28R15XXX
	100	7.3x4.3x2.8	15	2000	63	SA20JM101A28R15XXX
		7.3x4.3x2.8	10	3000	94.5	SA20JM151A28R10XXX
	150	7.3x4.3x2.8	15	3000	94.5	SA20JM151A28R15XXX
		7.3x4.3x2.8	10	3000	138.6	SA20JM221A28R10XXX
220	7.3x4.3x2.8	15	3000	138.6	SA20JM221A28R15XXX	
7.5 (8.6)	150	7.3x4.3x2.8	10	3000	112.5	SA20AM151A28R10XXX
	200	7.3x4.3x2.8	12	3000	150	SA20AM201A28R12XXX
10 (11.5)	10	7.3x4.3x2.8	55	1000	10	SA21AM100A28R55XXX
	22	7.3x4.3x2.8	28	1600	22	SA21AM220A28R28XXX
	33	7.3x4.3x2.8	25	1800	33	SA21AM330A28R25XXX
	68	7.3x4.3x2.8	15	2000	68	SA21AM680A28R15XXX
	100	7.3x4.3x2.8	15	2500	100	SA21AM101A28R15XXX
12.5 (14.4)	10	7.3x4.3x2.8	55	1000	12.5	SA21TM100A28R55XXX
	15	7.3x4.3x2.8	45	1000	18.8	SA21TM150A28R45XXX
	22	7.3x4.3x2.8	30	1600	27.5	SA21TM220A28R30XXX
	33	7.3x4.3x2.8	25	1800	41.3	SA21TM330A28R25XXX
	47	7.3x4.3x2.8	20	2000	58.8	SA21TM470A28R20XXX
	56	7.3x4.3x2.8	15	2000	70.0	SA21TM560A28R15XXX
	100	7.3x4.3x2.8	12	2500	125.0	SA21TM101A28R12XXX
16 (18.4)	6.8	7.3x4.3x2.8	70	1000	10.9	SA21CM6R8A28R70XXX
	10	7.3x4.3x2.8	60	1000	16.0	SA21CM100A28R60XXX
	15	7.3x4.3x2.8	40	1000	24.0	SA21CM150A28R40XXX
	22	7.3x4.3x2.8	30	1600	35.2	SA21CM220A28R30XXX
	33	7.3x4.3x2.8	30	1600	52.8	SA21CM330A28R30XXX
	47	7.3x4.3x2.8	30	1600	75.2	SA21CM470A28R30XXX
	68	7.3x4.3x2.8	30	1600	108.8	SA21CM680A28R30XXX
	100	7.3x4.3x2.8	25	1800	160	SA21CM101A28R25XXX
25 (28.8)	10	7.3x4.3x2.8	45	1000	25.0	SA21EM100A28R45XXX
	33	7.3x4.3x2.8	60	1400	82.5	SA21EM330A28R60XXX

Conductive Polymer Multilayer Type

Specifications may be subject to change without notice.

PZ series

- Endurance: +105°C 2,000 hours
- Low ESR
- Recommended Applications: System Board, Display Card, Small Charger and intelligent TV
- RoHS Compliant and lead-free

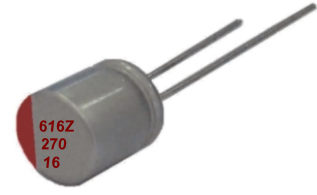

SPECIFICATIONS

Items	Characteristics											
Category Temperature Range	-55~+105°C											
Rated Working Voltage Range	6.3~100 V _{dc}											
Nominal Capacitance Range	4.7~5600μF											
Capacitance Tolerance	±20%(M) (at 20°C, 120Hz)											
DC Leakage Current	I ≤ 0.2CV or 500μA, whichever is greater. Where, I:Max.leakage current (μA), C:Nominal capacitance (μF), V: Rated voltage (V) (at 20°C after 2 minutes)											
Dissipation Factor (tan δ)	Rated Voltage(V _{dc})	6.3	6.8	7.5	10	16	25	35	50	63	100	
	tan δ (max.)	0.08						0.12		0.15		(at 20°C, 120Hz)
ESR(100kHz, 20°C)	Value in characteristics table											
Temperature Characteristic (Impedance Ratio at 100kHz)	Z(+105°C)/Z(+20°C) 1.25 Z(-55°C)/Z(+20°C) 1.25											
Endurance	After applying rated voltage for 2,000 hours at 105°C, the capacitors shall meet the following requirements.											
	Appearance	No significant damage										
	Capacitance Change	±20% of the initial value										
	D.F. (tan δ)	150% of the initial specified value										
	ESR	150% of the initial specified value										
Humidity Test	After subjecting to 90%~95% RH for 2,000 hours at 60°C without voltage applied, the capacitors shall meet the specified values for the Endurance characteristics listed above.											
	Surge Test	After subjecting to 1,000 cycles each consisting of charge with the surge voltage specified at normal temperature for 30 seconds through a protective resistor and discharge for 5 minutes 30 seconds, the capacitors shall meet the following requirements.										
		Appearance	No significant damage									
		Capacitance Change	±20% of the initial value									
		D.F. (tan δ)	150% of the initial specified value									
ESR		150% of the initial specified value										
Leakage Current	The initial specified value											

DIMENSIONS[mm]

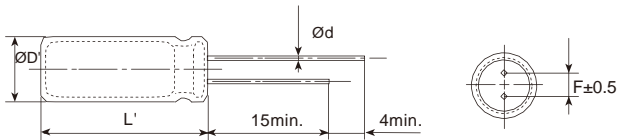

ØD	5	5.5	6.3	8	10
Ød	0.5	0.5	0.5	0.6	0.6
F	2.0	2.5	2.5	3.5	5.0
ØD'	ØD-0.1~+0.5				
L'	L+1.0max.			L-0.5~+1	

PART NUMBERING SYSTEM

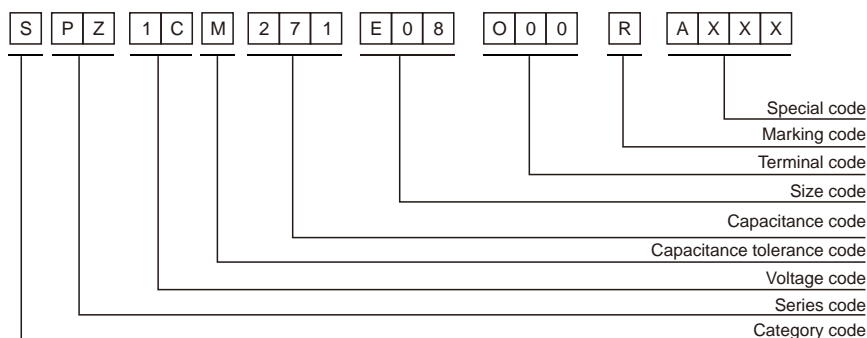

PZ series

■ STANDARD RATINGS

VDC (SV)	Cap (μF)	Size DxL(mm)	ESR (mΩ, 20°C, 100kHz) (max.)	Rated ripple current (mArms/105°C, 100kHz)	Leakage Current (μA)(max.)	Part Number
6.3 (7.2)	100	5x7	30	1800	500	SPZ0JM101D07O00RAXXX
	220	5x7	20	3500	500	SPZ0JM221D07O00RAXXX
	270	6.3x7	20	3900	500	SPZ0JM221E07O00RAXXX
		5x7	20	3800	500	SPZ0JM271D07O00RAXXX
	330	5x8	20	4000	500	SPZ0JM331D08O00RAXXX
		6.3x5	25	3160	500	SPZ0JM331E05O00RAXXX
	390	6.3x8	15	4000	500	SPZ0JM331E08O00RAXXX
		5x9	20	4100	500	SPZ0JM391D09O00RAXXX
	470	5x10	20	4300	592	SPZ0JM471D10O00RAXXX
		5.5x9	20	4100	592	SPZ0JM471B09O00RAXXX
		6.3x7	20	3900	592	SPZ0JM471E07O00RAXXX
	500	6.3x8	15	4400	592	SPZ0JM471E08O00RAXXX
		5x9	20	4100	630	SPZ0JM501D09O00RAXXX
		6.3x7	20	4200	706	SPZ0JM561E07O00RAXXX
	560	6.3x8	20	4800	706	SPZ0JM561E08O00RAXXX
		5.5x9	20	4300	706	SPZ0JM561B09O00RAXXX
	680	6.3x9	20	5080	857	SPZ0JM681E09O00RAXXX
		5.5x9	20	4800	857	SPZ0JM681B09O00RAXXX
		8x9	20	4600	857	SPZ0JM681F09O00RAXXX
	820	5.5x12	20	5000	1033	SPZ0JM821B12O00RAXXX
		6.3x9	20	5080	1033	SPZ0JM821E09O00RAXXX
		8x9	15	4700	1033	SPZ0JM821F09O00RAXXX
	1000	6.3x10	10	5150	1260	SPZ0JM102E10O00RAXXX
		8x9	12	4800	1260	SPZ0JM102F09O00RAXXX
		8x11	10	5200	1260	SPZ0JM102F11O00RAXXX
	1200	6.3x11	10	5200	1512	SPZ0JM122E11O00RAXXX
		8x11	10	5300	1512	SPZ0JM122F11O00RAXXX
	1500	8x11	10	5400	1890	SPZ0JM152F11O00RAXXX
1800	10x12	10	5500	1890	SPZ0JM152G12O00RAXXX	
	10x10	10	5560	2268	SPZ0JM182G10O00RAXXX	
2200	8x14	10	5700	2772	SPZ0JM222F14O00RAXXX	
4700	10x12	10	5800	2772	SPZ0JM222G12O00RAXXX	
	10x14	10	5900	4158	SPZ0JM332G14O00RAXXX	
	10x17	10	6100	5000	SPZ0JM472G17O00RAXXX	
	10x18	10	6300	5000	SPZ0JM562G18O00RAXXX	
6.8 (7.8)	220	5x7	20	3300	500	SPZ0CM221D07O00RAXXX
	270	5x7	20	3600	500	SPZ0CM271D07O00RAXXX
		6.3x8	20	3900	500	SPZ0CM271E08O00RAXXX
	330	5x8	20	3800	500	SPZ0CM331D08O00RAXXX
		6.3x5	25	3100	500	SPZ0CM331E05O00RAXXX
	390	6.3x7	20	3400	500	SPZ0CM331E07O00RAXXX
		5x9	20	3900	530	SPZ0CM391D09O00RAXXX
	470	5x9	20	4100	639	SPZ0CM471D09O00RAXXX
		6.3x7	20	3700	639	SPZ0CM471E07O00RAXXX
	560	6.3x8	20	4500	762	SPZ0CM561E08O00RAXXX
	680	6.3x9	20	4800	925	SPZ0CM681E09O00RAXXX
	820	6.3x9	20	4900	1115	SPZ0CM821E09O00RAXXX
6.3x11		12	5100	1360	SPZ0CM102E11O00RAXXX	
1000	8x11	10	5150	1360	SPZ0CM102F11O00RAXXX	
7 (8.1)	150	5x6	30	1500	500	SPZ0QM151D06O00RAXXX
	220	5x7	20	3200	500	SPZ0QM221D07O00RAXXX
	270	5x8	20	3400	500	SPZ0QM271D08O00RAXXX
	330	5x9	20	3600	500	SPZ0QM331D09O00RAXXX
		6.3x8	20	3800	658	SPZ0QM471E08O00RAXXX
	470	5.5x9	20	3600	658	SPZ0QM471B09O00RAXXX
		6.3x8	20	4000	784	SPZ0QM561E08O00RAXXX
	680	6.3x9	12	4200	952	SPZ0QM681E09O00RAXXX
820	6.3x10	12	4500	1148	SPZ0QM821E10O00RAXXX	
	8x9	12	4600	1148	SPZ0QM821F09O00RAXXX	
7.5 (8.6)	220	5x7	20	3100	500	SPZ0AM221D07O00RAXXX
	270	5x8	20	3300	500	SPZ0AM271D08O00RAXXX
	330	5x8	20	3500	500	SPZ0AM331D08O00RAXXX
	390	5x9	20	3500	585	SPZ0AM391D09O00RAXXX
		6.3x7	25	3200	705	SPZ0AM471E07O00RAXXX
	470	5.5x9	20	3550	705	SPZ0AM471B09O00RAXXX
		5x9	20	3550	705	SPZ0AM471D09O00RAXXX
		5.5x8	25	3100	705	SPZ0AM471B08O00RAXXX
	500	5.5x9	20	3600	750	SPZ0AM501B09O00RAXXX
	560	6.3x8	20	3900	840	SPZ0AM561E08O00RAXXX
	680	6.3x9	12	4100	1020	SPZ0AM681E09O00RAXXX
	820	6.3x10	12	4400	1230	SPZ0AM821E10O00RAXXX
		8x9	12	4550	1230	SPZ0AM821F09O00RAXXX
	1000	8x11	12	4700	1500	SPZ0AM102F11O00RAXXX
		6.3x11	12	4500	1500	SPZ0AM102E11O00RAXXX
		8x11	12	4800	1800	SPZ0AM122F11O00RAXXX
		8x11	12	4900	2250	SPZ0AM152F11O00RAXXX
	1500	6.8x13	12	4800	2250	SPZ0AM152Q13O00RAXXX
1800	8x14	12	5100	2700	SPZ0AM182F14O00RAXXX	
2200	10x12	12	5700	3300	SPZ0AM222G12O00RAXXX	
10 (11.5)	47	5x7	35	2200	500	SPZ1AM470D07O00RAXXX
	56	5x7	35	2250	500	SPZ1AM560D07O00RAXXX
	68	5x7	35	2300	500	SPZ1AM680D07O00RAXXX
	82	5x7	35	2350	500	SPZ1AM820D07O00RAXXX
	100	5x7	35	2400	500	SPZ1AM101D07O00RAXXX
	120	6.3x5	30	2300	500	SPZ1AM101E05O00RAXXX
		5x7	20	2450	500	SPZ1AM121D07O00RAXXX

Conductive Polymer Radial Type

PZ series

■ STANDARD RATINGS

VDC (SV)	Cap (μF)	Size DxL(mm)	ESR (mΩ, 20°C, 100kHz) (max.)	Rated ripple current (mArms/105°C, 100kHz)	Leakage Current (μA)(max.)	Part Number
10 (11.5)	150	5x7	20	2500	500	SPZ1AM151D07O00RAXXX
	180	6.3x7	20	2800	500	SPZ1AM181E07O00RAXXX
		5x8	20	2700	500	SPZ1AM181D08O00RAXXX
	220	5x9	20	2820	500	SPZ1AM221D09O00RAXXX
		6.3x5	25	2800	500	SPZ1AM221E05O00RAXXX
	270	6.3x8	15	3160	500	SPZ1AM221E08O00RAXXX
		6.3x8	20	3100	540	SPZ1AM271E08O00RAXXX
	330	6.3x8	20	3300	660	SPZ1AM331E08O00RAXXX
		8x9	15	3400	660	SPZ1AM331F09O00RAXXX
	390	6.3x10	12	3500	660	SPZ1AM331E10O00RAXXX
		6.3x8	20	3400	780	SPZ1AM391E08O00RAXXX
	470	5.5x9	20	3400	940	SPZ1AM471B09O00RAXXX
		6.3x8	20	3500	940	SPZ1AM471E08O00RAXXX
	560	8x9	15	3550	940	SPZ1AM471F09O00RAXXX
		8x11	12	5650	940	SPZ1AM471F11O00RAXXX
	680	6.3x10	13	3600	1120	SPZ1AM561E10O00RAXXX
		8x9	15	3600	1120	SPZ1AM561F09O00RAXXX
	820	8x11	12	3900	1360	SPZ1AM681F11O00RAXXX
		8x8	20	3300	1360	SPZ1AM681F08O00RAXXX
	1000	8x11	12	4000	1640	SPZ1AM821F11O00RAXXX
		10x12	10	4200	2000	SPZ1AM102F11O00RAXXX
	1200	8x12	10	5300	2000	SPZ1AM102G12O00RAXXX
		10x12	10	4500	2400	SPZ1AM122F12O00RAXXX
	1500	10x12	10	5450	2400	SPZ1AM122G12O00RAXXX
8x14		10	5500	3000	SPZ1AM152G12O00RAXXX	
1800	10x13	10	4800	3000	SPZ1AM152F14O00RAXXX	
	10x15	10	5800	3600	SPZ1AM182G13O00RAXXX	
2200	10x15	10	6100	4400	SPZ1AM222G15O00RAXXX	
	10x18	10	6200	5000	SPZ1AM332G18O00RAXXX	
12 (13.8)	330	5.5x9	20	3100	792	SPZ1TM331B09O00RAXXX
		6.3x8	20	3100	792	SPZ1TM331E08O00RAXXX
	470	5.5x9	20	3200	1128	SPZ1TM471B09O00RAXXX
		6.3x9	20	3450	1128	SPZ1TM471E09O00RAXXX
	560	6.3x10	15	3400	1344	SPZ1TM561E10O00RAXXX
		6.3x11	15	3600	1632	SPZ1TM681E11O00RAXXX
	680	8x10	15	3700	1632	SPZ1TM681F10O00RAXXX
		8x11	12	3800	1968	SPZ1TM821F11O00RAXXX
	1000	8x12	12	4000	2400	SPZ1TM102F12O00RAXXX
		8x14	12	4400	2880	SPZ1TM122F14O00RAXXX
	1500	8x16	12	4800	3600	SPZ1TM152F16O00RAXXX
		22	5x9	80	1600	500
16 (18.4)	47	5x7	20	2050	500	SPZ1CM470D07O00RAXXX
	56	5x7	20	2100	500	SPZ1CM560D07O00RAXXX
	68	5x7	20	2150	500	SPZ1CM680D07O00RAXXX
	82	5x8	20	2200	500	SPZ1CM820D08O00RAXXX
		5x7	20	2250	500	SPZ1CM101D07O00RAXXX
	100	6.3x5	25	2100	500	SPZ1CM101E05O00RAXXX
		6.3x8	20	2800	500	SPZ1CM101E08O00RAXXX
	120	5x8	20	2350	500	SPZ1CM121D08O00RAXXX
	150	5x8	20	2400	500	SPZ1CM151D08O00RAXXX
		5x8	20	2450	576	SPZ1CM181D08O00RAXXX
	180	6.3x7	16	2500	576	SPZ1CM181E07O00RAXXX
		5x10	20	2600	704	SPZ1CM221D10O00RAXXX
	220	6.3x8	20	2700	704	SPZ1CM221E08O00RAXXX
		6.3x10	15	2900	704	SPZ1CM221E10O00RAXXX
	270	5.5x9	20	2750	864	SPZ1CM271B09O00RAXXX
		6.3x8	20	2800	864	SPZ1CM271E08O00RAXXX
	330	8x9	20	2900	864	SPZ1CM271F09O00RAXXX
		5.5x9	20	2900	1056	SPZ1CM331B09O00RAXXX
	390	6.3x9	20	2900	1056	SPZ1CM331E09O00RAXXX
		6.3x10	15	3100	1056	SPZ1CM331E10O00RAXXX
	470	5.5x11	20	3100	1504	SPZ1CM471B11O00RAXXX
		6.3x11	15	3200	1504	SPZ1CM471E11O00RAXXX
	560	8x11	11	4600	1504	SPZ1CM471F11O00RAXXX
		8x9	13	4100	1504	SPZ1CM471F09O00RAXXX
680	8x11	11	3200	1792	SPZ1CM561F11O00RAXXX	
	8x13	15	3300	1792	SPZ1CM561F13O00RAXXX	
820	10x12	11	3500	1792	SPZ1CM561G12O00RAXXX	
	8x11	15	3400	2176	SPZ1CM681F11O00RAXXX	
1000	10x12	11	3600	2176	SPZ1CM681G12O00RAXXX	
	8x13	11	3500	2624	SPZ1CM821F13O00RAXXX	
1200	10x12	11	3800	2624	SPZ1CM821G12O00RAXXX	
	10x12	11	4000	3200	SPZ1CM102G12O00RAXXX	
1500	8x14	11	3600	3200	SPZ1CM102F14O00RAXXX	
	10x15	12	4300	3840	SPZ1CM122G15O00RAXXX	
1800	10x12	12	4200	3840	SPZ1CM122G12O00RAXXX	
	10x12	12	4800	4800	SPZ1CM152G12O00RAXXX	
2200	10x18	12	5500	4800	SPZ1CM152G18O00RAXXX	
	10x14	12	5400	5000	SPZ1CM182G14O00RAXXX	
20	10x17	12	5800	5000	SPZ1CM222G17O00RAXXX	
	10x15	12	5500	5000	SPZ1CM222G15O00RAXXX	
20 (23.0)	120	6.3x8	30	2300	500	SPZ1DM121E08O00RAXXX
	150	6.3x10	20	2350	600	SPZ1DM151E10O00RAXXX
		8x11	20	2550	880	SPZ1DM221F11O00RAXXX
	270	8x11	20	2700	1080	SPZ1DM271F11O00RAXXX
		8x11	20	2800	1320	SPZ1DM331F11O00RAXXX
	330	6.3x10	20	2100	1320	SPZ1DM331E10O00RAXXX
		10x12	20	2900	1880	SPZ1DM471G12O00RAXXX
	470	8x16	20	3000	1880	SPZ1DM471F16O00RAXXX
8x11		20	2400	1880	SPZ1DM471F11O00RAXXX	

PZ series

■ STANDARD RATINGS

VDC (SV)	Cap (μF)	Size DxDL(mm)	ESR (mΩ, 20°C, 100kHz) (max.)	Rated ripple current (mArms/105°C, 100kHz)	Leakage Current (μA)(max.)	Part Number	
20 (23.0)	560	10x12	20	3100	2240	SPZ1DM561G12O00RAXXX	
		8x16	20	3200	2240	SPZ1DM561F16O00RAXXX	
	680	10x15	20	3300	2720	SPZ1DM681G15O00RAXXX	
		8x14	20	2700	2720	SPZ1DM681F14O00RAXXX	
	820	10x18	20	3400	3280	SPZ1DM821G18O00RAXXX	
	1000	10x18	20	3900	4000	SPZ1DM102G18O00RAXXX	
25 (28.8)	6.8	6.3x5	100	1100	500	SPZ1EM6R8E05O00RAXXX	
	10	5x8	70	1800	500	SPZ1EM100D08O00RAXXX	
	22	5x9	60	1810	500	SPZ1EM220D09O00RAXXX	
	33	5x9	50	1850	500	SPZ1EM330D09O00RAXXX	
	39	5x8	60	1900	500	SPZ1EM390D08O00RAXXX	
	47	5x9	60	1950	500	SPZ1EM470D09O00RAXXX	
	56	5x9	60	2050	500	SPZ1EM560D09O00RAXXX	
	68	6.3x7	30	2100	500	SPZ1EM680E07O00RAXXX	
	82	6.3x7	30	2150	500	SPZ1EM820E07O00RAXXX	
	100	6.3x8	30	2500	500	SPZ1EM101E08O00RAXXX	
		6.3x10	20	2800	500	SPZ1EM101E10O00RAXXX	
	120	8x11	20	3000	500	SPZ1EM101F11O00RAXXX	
		6.3x8	30	2500	600	SPZ1EM121E08O00RAXXX	
	150	6.3x10	20	2800	750	SPZ1EM151E10O00RAXXX	
	180	6.3x10	20	2800	900	SPZ1EM181E10O00RAXXX	
		8x9	30	2500	900	SPZ1EM181F09O00RAXXX	
	220	8x11	20	3000	1100	SPZ1EM221F11O00RAXXX	
		10x12	20	3500	1100	SPZ1EM221G12O00RAXXX	
	270	5.5x11	20	1900	1100	SPZ1EM221B11O00RAXXX	
		8x11	20	3000	1350	SPZ1EM271F11O00RAXXX	
	330	8x11	20	3100	1650	SPZ1EM331F11O00RAXXX	
		10x12	20	3800	1650	SPZ1EM331G12O00RAXXX	
	470	10x10	25	2800	1650	SPZ1EM331G10O00RAXXX	
		10x12	20	4000	2350	SPZ1EM471G12O00RAXXX	
	560	8x16	20	3400	2350	SPZ1EM471F16O00RAXXX	
		8x11	20	3000	2350	SPZ1EM471F11O00RAXXX	
	680	10x10	25	2800	2350	SPZ1EM471G10O00RAXXX	
		10x12	20	4000	2800	SPZ1EM561G12O00RAXXX	
	820	8x12	20	3100	2800	SPZ1EM561F12O00RAXXX	
		10x15	20	4300	3400	SPZ1EM681G15O00RAXXX	
	1000	10x12	20	4100	3400	SPZ1EM681G12O00RAXXX	
		8x14	20	3400	3400	SPZ1EM681F14O00RAXXX	
	220	10x18	20	4500	4100	SPZ1EM821G18O00RAXXX	
		10x12	20	4100	4100	SPZ1EM821G12O00RAXXX	
	470	8x16	20	3600	4100	SPZ1EM821F16O00RAXXX	
		10x18	20	4500	5000	SPZ1EM102G18O00RAXXX	
	35 (40.3)	4.7	5x8	60	1700	500	SPZ1VM4R7D08O00RAXXX
		10	5x8	60	1800	500	SPZ1VM100D08O00RAXXX
		15	5x8	60	1850	500	SPZ1VM150D08O00RAXXX
		22	5x9	100	1950	500	SPZ1VM220D09O00RAXXX
33		5x9	50	2000	500	SPZ1VM330D09O00RAXXX	
39		5x9	50	2050	500	SPZ1VM390D09O00RAXXX	
47		6.3x7	50	2100	500	SPZ1VM470E07O00RAXXX	
56		6.3x7	50	2150	500	SPZ1VM560E07O00RAXXX	
68		6.3x7	50	2200	500	SPZ1VM680E07O00RAXXX	
82		6.3x7	50	2250	574	SPZ1VM820E07O00RAXXX	
100		6.3x8	50	2350	700	SPZ1VM101E08O00RAXXX	
		6.3x10	40	2400	700	SPZ1VM101E10O00RAXXX	
120		8x11	40	2600	700	SPZ1VM101F11O00RAXXX	
		6.3x10	40	2500	840	SPZ1VM121E10O00RAXXX	
150		6.3x10	40	2550	1050	SPZ1VM151E10O00RAXXX	
180		6.3x11	40	2600	1260	SPZ1VM181E11O00RAXXX	
		8x11	40	2800	1540	SPZ1VM221F11O00RAXXX	
220		10x12	30	2900	1540	SPZ1VM221G12O00RAXXX	
		6.3x11	40	2600	1540	SPZ1VM221E11O00RAXXX	
270		10x12	30	3000	1890	SPZ1VM271G12O00RAXXX	
330		10x12	30	3100	2310	SPZ1VM331G12O00RAXXX	
470		10x13	20	3200	3290	SPZ1VM471G13O00RAXXX	
560		10x14	20	3300	3920	SPZ1VM561G14O00RAXXX	
680		10x16	20	3400	4760	SPZ1VM681G16O00RAXXX	
820		10x18	20	3500	5000	SPZ1VM821G18O00RAXXX	
1000		10x18	20	3700	5000	SPZ1VM102G18O00RAXXX	
50 (57.5)		4.7	5x8	60	1600	500	SPZ1HM4R7D08O00RAXXX
		10	6.3x7	35	1850	500	SPZ1HM100E07O00RAXXX
		15	5x8	70	1630	500	SPZ1HM100D08O00RAXXX
		22	5x8	70	1660	500	SPZ1HM150D08O00RAXXX
		33	6.3x7	40	1900	500	SPZ1HM220E07O00RAXXX
		39	6.3x7	40	2000	500	SPZ1HM330E07O00RAXXX
		47	6.3x8	35	2100	500	SPZ1HM470E08O00RAXXX
		56	6.3x8	35	2120	560	SPZ1HM560E08O00RAXXX
		68	6.3x10	30	2150	680	SPZ1HM680E10O00RAXXX
		100	8x11	30	2300	1000	SPZ1HM101F11O00RAXXX
			8x9	40	2100	1000	SPZ1HM101F09O00RAXXX
		120	8x11	30	2400	1200	SPZ1HM121F11O00RAXXX
		150	10x12	30	2500	1500	SPZ1HM151G12O00RAXXX
		180	10x12	30	2600	1800	SPZ1HM181G12O00RAXXX
	220	10x12	30	2700	2200	SPZ1HM221G12O00RAXXX	
	270	10x13	20	2900	2700	SPZ1HM271G13O00RAXXX	
	330	10x15	20	3000	3300	SPZ1HM331G15O00RAXXX	
	440	10x18	20	3100	4400	SPZ1HM441G18O00RAXXX	
	470	10x18	20	3150	4700	SPZ1HM471G18O00RAXXX	
	63(72.5)	4.7	6.3x8	60	1600	500	SPZ1JM4R7E08O00RAXXX

Conductive Polymer Radial Type

PZ series

■ STANDARD RATINGS

VDC (SV)	Cap (μF)	Size DxL(mm)	ESR (mΩ, 20°C, 100kHz) (max.)	Rated ripple current (mA rms/105°C, 100kHz)	Leakage Current (μA)(max.)	Part Number
63 (72.5)	6.8	6.3x8	60	1650	500	SPZ1JM6R8E08O00RAXXX
	10	6.3x5	60	1600	500	SPZ1JM100E05O00RAXXX
	33	6.3x8	30	1700	500	SPZ1JM330E08O00RAXXX
	39	6.3x8	30	1750	500	SPZ1JM390E08O00RAXXX
	47	6.3x9	30	1900	592	SPZ1JM470E09O00RAXXX
	56	8x9	30	1800	706	SPZ1JM560F09O00RAXXX
	68	8x11	30	2000	857	SPZ1JM680F11O00RAXXX
	82	8x11	30	2100	1033	SPZ1JM820F11O00RAXXX
	100	10x12	30	2200	1260	SPZ1JM101G12O00RAXXX
	150	10x12	30	2500	1890	SPZ1JM151G12O00RAXXX
	180	10x13	20	2600	2268	SPZ1JM181G13O00RAXXX
	220	10x15	20	2650	2772	SPZ1JM221G15O00RAXXX
	270	10x17	20	2850	3402	SPZ1JM271G17O00RAXXX
	330	10x18	20	2950	4158	SPZ1JM331G18O00RAXXX
80 (92.0)	4.7	6.3x8	60	1500	500	SPZ1BM4R7E08O00RAXXX
	6.8	6.3x8	60	1550	500	SPZ1BM6R8E08O00RAXXX
	22	6.3x10	60	1650	500	SPZ1BM220E10O00RAXXX
	33	8x11	35	1700	528	SPZ1BM330F11O00RAXXX
	47	10x12	35	1850	752	SPZ1BM470G12O00RAXXX
	68	10x12	35	1900	1088	SPZ1BM680G12O00RAXXX
	100	10x14	35	2100	1600	SPZ1BM101G14O00RAXXX
100 (115.0)	4.7	6.3x8	120	1400	500	SPZ1KM4R7E08O00RAXXX
	6.8	6.3x8	120	1450	500	SPZ1KM6R8E08O00RAXXX
	10	6.3x10	50	1500	500	SPZ1KM100E10O00RAXXX
	15	8x11	50	1550	500	SPZ1KM100F11O00RAXXX
	22	10x12	35	1600	500	SPZ1KM150F11O00RAXXX
	33	10x14	35	1650	660	SPZ1KM220G12O00RAXXX
	47	10x14	35	1650	660	SPZ1KM330G14O00RAXXX
	47	10x16	35	1800	940	SPZ1KM470G16O00RAXXX

Specifications subject to change without notice.

PD series

- Endurance: +105°C 2,000 hours
- Low ESR, Small Size
- Recommended Applications: High order main board, Industrial computer
- RoHS Compliant and lead-free

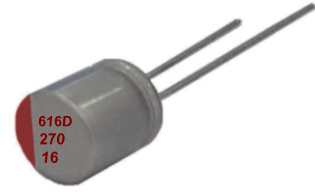

SPECIFICATIONS

Items	Characteristics							
Category Temperature Range	-55~+105°C							
Rated Working Voltage Range	6.3~35 V _{dc}							
Nominal Capacitance Range	47~4700μF							
Capacitance Tolerance	±20%(M) (at 20°C, 120Hz)							
DC Leakage Current	I ≤ 0.2CV or 500μA, whichever is greater. Where, I: Max. leakage current (μA), C: Nominal capacitance (μF), V: Rated voltage (V) (at 20°C after 2 minutes)							
Dissipation Factor (tan δ)	Rated Voltage (V _{dc})	6.3	6.8	7.5	10	16	20	35
	tan δ (max.)	0.08			0.12			
ESR(100kHz, 20°C)	Value in characteristics table							
Temperature Characteristic (Impedance Ratio at 100kHz)	Z(+105°C)/Z(+20°C) 1.25 Z(-55°C)/Z(+20°C) 1.25							
Endurance	After applying rated voltage for 2,000 hours at 105°C, the capacitors shall meet the following requirements.							
	Appearance	No significant damage						
	Capacitance Change	±20% of the initial value						
	D.F. (tan δ)	150% of the initial specified value						
	ESR	150% of the initial specified value						
	Leakage Current	The initial specified value						
Humidity Test	After subjecting to 90%~95% RH for 2,000 hours at 60°C without voltage applied, the capacitors shall meet the specified values for the endurance characteristics listed above.							
Surge Test	After subjecting to 1,000 cycles each consisting of charge with the surge voltage specified at normal temperature for 30 seconds through a protective resistor and discharge for 5 minutes 30 seconds, the capacitors shall meet the following requirements.							
	Appearance	No significant damage						
	Capacitance Change	±20% of the initial value						
	D.F. (tan δ)	150% of the initial specified value						
	ESR	150% of the initial specified value						
	Leakage Current	The initial specified value						

Conductive Polymer Radial Type

DIMENSIONS [mm]

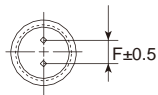
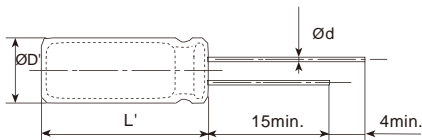

ØD	5	5.5	6.3	8	10
Ød	0.5	0.5	0.5	0.6	0.6
F	2.0	2.5	2.5	3.5	5.0
ØD'	ØD-0.1~+0.5				
L'	L+1.0max.			L-0.5~+1	

PART NUMBERING SYSTEM

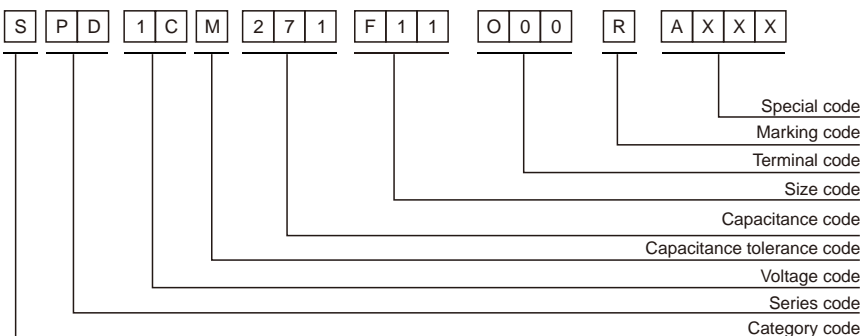

PD series

■ STANDARD RATINGS

VDC (SV)	Cap (μF)	Size DxL(mm)	ESR (mΩ, 20°C, 100kHz) (max.)	Rated ripple current (mA rms/105°C, 100kHz)	Leakage Current (μA)(max.)	Part Number
6.3 (7.2)	220	5x7	18	3600	500	SPD0JM221D07000RAXXX
	270	5x7	18	3900	500	SPD0JM271D07000RAXXX
	330	5x8	18	4200	500	SPD0JM331D08000RAXXX
	390	5x9	18	4300	500	SPD0JM391D09000RAXXX
	470	5x10	18	4500	592	SPD0JM471D10000RAXXX
		5.5x9	18	4300	592	SPD0JM471B09000RAXXX
		6.3x7	18	4000	592	SPD0JM471E07000RAXXX
	500	5x9	18	4300	630	SPD0JM501D09000RAXXX
		6.3x7	18	4400	706	SPD0JM561E07000RAXXX
	560	5.5x9	18	4500	706	SPD0JM561B09000RAXXX
		6.3x9	18	5300	857	SPD0JM681E09000RAXXX
	680	5.5x9	18	5000	857	SPD0JM681B09000RAXXX
		5.5x11	18	5000	1033	SPD0JM821B11000RAXXX
	820	6.3x9	18	5300	1033	SPD0JM821E09000RAXXX
		6.3x10	9	5400	1260	SPD0JM102E10000RAXXX
	1000	8x9	10	5000	1260	SPD0JM102F09000RAXXX
	1500	8x11	9	5600	1890	SPD0JM152F11000RAXXX
	1800	10x10	9	5800	2268	SPD0JM182G10000RAXXX
2200	8x14	9	5900	2772	SPD0JM222F14000RAXXX	
	10x12	9	6000	2772	SPD0JM222G12000RAXXX	
3300	10x14	9	6100	4158	SPD0JM332G14000RAXXX	
6.8 (7.8)	47	6.3x5	40	1100	500	SPD0CM470E05000RAXXX
	82	6.3x5	40	1100	500	SPD0CM820E05000RAXXX
		4x7	30	1500	500	SPD0CM101C07000RAXXX
	100	5x7	30	1800	500	SPD0CM101D07000RAXXX
		6.3x6	40	1900	500	SPD0CM101E06000RAXXX
	150	4x7	30	2100	500	SPD0CM151C07000RAXXX
		5x7	30	2600	500	SPD0CM151D07000RAXXX
	220	5x7	20	3500	500	SPD0CM221D07000RAXXX
		6.3x7	20	3550	500	SPD0CM221E07000RAXXX
		6.3x8	15	3600	500	SPD0CM221E08000RAXXX
	270	5x7	20	3800	500	SPD0CM271D07000RAXXX
		5x6	20	3200	500	SPD0CM271D06000RAXXX
	330	5x8	20	4000	500	SPD0CM331D08000RAXXX
		6.3x5	25	3160	500	SPD0CM331E05000RAXXX
		6.3x8	15	4000	500	SPD0CM331E08000RAXXX
	390	5x9	20	4100	530	SPD0CM391D09000RAXXX
		5x10	20	4300	639	SPD0CM471D10000RAXXX
	470	5.5x9	20	4100	639	SPD0CM471B09000RAXXX
		6.3x7	20	3900	639	SPD0CM471E07000RAXXX
		6.3x8	15	4400	639	SPD0CM471E08000RAXXX
	500	5x9	20	4100	680	SPD0CM501D09000RAXXX
		6.3x7	20	4200	762	SPD0CM561E07000RAXXX
	560	6.3x8	20	4800	762	SPD0CM561E08000RAXXX
		5.5x9	20	4300	762	SPD0CM561B09000RAXXX
	680	6.3x9	20	5080	925	SPD0CM681E09000RAXXX
		5.5x9	20	4800	925	SPD0CM681B09000RAXXX
		8x9	20	4600	925	SPD0CM681F09000RAXXX
	820	5.5x10	20	4800	1115	SPD0CM821B10000RAXXX
		6.3x9	20	5080	1115	SPD0CM821E09000RAXXX
		8x9	15	4700	1115	SPD0CM821F09000RAXXX
	1000	6.3x10	10	5150	1360	SPD0CM102E10000RAXXX
		8x9	12	4800	1360	SPD0CM102F09000RAXXX
		8x11	10	5200	1360	SPD0CM102F11000RAXXX
		6.3x11	10	5200	1632	SPD0CM122E11000RAXXX
	1200	8x11	10	5300	1632	SPD0CM122F11000RAXXX
		8x11	10	5400	2040	SPD0CM152F11000RAXXX
	1500	10x12	10	5500	2040	SPD0CM152G12000RAXXX
	1800	10x10	10	5560	2448	SPD0CM182G10000RAXXX
	2200	8x14	10	5700	2992	SPD0CM222F14000RAXXX
		10x12	10	5800	2992	SPD0CM222G12000RAXXX
	3300	10x14	10	5900	4488	SPD0CM332G14000RAXXX
	4700	10x17	10	6100	5000	SPD0CM472G17000RAXXX
7 (8.1)	150	5x6	30	1500	500	SPD0QM151D06000RAXXX
	220	5x7	20	3200	500	SPD0QM221D07000RAXXX
	270	5x8	20	3400	500	SPD0QM271D08000RAXXX
	330	5x9	20	3600	500	SPD0QM331D09000RAXXX
	470	6.3x8	20	3800	658	SPD0QM471E08000RAXXX
		5.5x9	20	3600	658	SPD0QM471B09000RAXXX
	560	6.3x8	20	4000	784	SPD0QM561E08000RAXXX
	680	6.3x8	12	4200	952	SPD0QM681E08000RAXXX
820	6.3x10	12	4500	1148	SPD0QM821E10000RAXXX	
	8x9	12	4600	1148	SPD0QM821F09000RAXXX	
7.5 (8.6)	220	5x7	20	3100	500	SPD0AM221D07000RAXXX
	270	5x8	20	3300	500	SPD0AM271D08000RAXXX
	330	5x9	20	3500	500	SPD0AM331D09000RAXXX
	390	5x9	20	3500	585	SPD0AM391D09000RAXXX
		6.3x7	25	3200	705	SPD0AM471E07000RAXXX
	470	5.5x9	20	3550	705	SPD0AM471B09000RAXXX
		5x9	20	3550	705	SPD0AM471D09000RAXXX
5.5x8	25	3100	705	SPD0AM471B08000RAXXX		

PD series

■ STANDARD RATINGS

VDC (SV)	Cap (μF)	Size DxL(mm)	ESR (mΩ, 20°C, 100kHz) (max.)	Rated ripple current (mA rms/105°C, 100kHz)	Leakage Current (μA)(max.)	Part Number
7.5 (8.6)	500	5.5x9	20	3600	750	SPD0AM501B09O00RAXXX
	560	6.3x8	20	3900	840	SPD0AM561E08O00RAXXX
	680	6.3x9	12	4100	1020	SPD0AM681E09O00RAXXX
	820	6.3x10	12	4400	1230	SPD0AM821E10O00RAXXX
		8x9	12	4550	1230	SPD0AM821F09O00RAXXX
	1000	8x11	12	4700	1500	SPD0AM102F11O00RAXXX
		6.3x11	12	4500	1500	SPD0AM102E11O00RAXXX
	1200	8x11	12	4800	1800	SPD0AM122F11O00RAXXX
	1500	8x11	12	4900	2250	SPD0AM152F11O00RAXXX
	1800	8x14	12	5100	2700	SPD0AM182F14O00RAXXX
2200	10x12	12	5700	3300	SPD0AM222G12O00RAXXX	
10 (11.5)	100	5x7	31	2500	500	SPD1AM101D07O00RAXXX
		6.3x5	27	2400	500	SPD1AM101E05O00RAXXX
	120	5x7	18	2500	500	SPD1AM121D07O00RAXXX
	150	5x7	18	2600	500	SPD1AM151D07O00RAXXX
	180	6.3x7	18	2900	500	SPD1AM181E07O00RAXXX
		5x8	18	2800	500	SPD1AM181D08O00RAXXX
	220	5x9	18	2900	500	SPD1AM221D09O00RAXXX
		6.3x5	22	2900	500	SPD1AM221E05O00RAXXX
	270	6.3x8	18	3200	540	SPD1AM271E08O00RAXXX
	330	6.3x8	18	3400	660	SPD1AM331E08O00RAXXX
	390	6.3x8	18	3500	780	SPD1AM391E08O00RAXXX
		5.5x9	18	3500	940	SPD1AM471B09O00RAXXX
	470	6.3x8	18	3600	940	SPD1AM471E08O00RAXXX
		8x9	13	3700	940	SPD1AM471F09O00RAXXX
	560	6.3x10	11	3700	1120	SPD1AM561E10O00RAXXX
		8x9	13	3700	1120	SPD1AM561F09O00RAXXX
	680	8x8	18	3400	1360	SPD1AM681F08O00RAXXX
	820	8x11	10	4200	1640	SPD1AM821F11O00RAXXX
	1000	8x11	10	4400	2000	SPD1AM102F11O00RAXXX
	1200	8x12	9	4700	2400	SPD1AM122F12O00RAXXX
	1500	8x14	9	5000	3000	SPD1AM152F14O00RAXXX
	1800	10x13	9	6000	3600	SPD1AM182G13O00RAXXX
12 (13.8)	47	5x7	35	2200	500	SPD1TM470D07O00RAXXX
	56	5x7	35	2250	500	SPD1TM560D07O00RAXXX
	68	5x7	35	2300	500	SPD1TM680D07O00RAXXX
	82	5x7	35	2350	500	SPD1TM820D07O00RAXXX
		5x7	35	2400	500	SPD1TM101D07O00RAXXX
	100	6.3x5	30	2300	500	SPD1TM101E05O00RAXXX
		5x5	30	2000	500	SPD1TM101D05O00RAXXX
	120	5x7	20	2450	500	SPD1TM121D07O00RAXXX
	150	5x7	20	2500	500	SPD1TM151D07O00RAXXX
		6.3x7	20	2800	500	SPD1TM181E07O00RAXXX
	180	5x8	20	2700	500	SPD1TM181D08O00RAXXX
		5x9	20	2820	528	SPD1TM221D09O00RAXXX
	220	6.3x5	25	2800	528	SPD1TM221E05O00RAXXX
		6.3x8	15	3160	528	SPD1TM221E08O00RAXXX
	270	6.3x8	20	3100	648	SPD1TM271E08O00RAXXX
		6.3x8	20	3300	792	SPD1TM331E08O00RAXXX
	330	8x9	15	3400	792	SPD1TM331F09O00RAXXX
		6.3x10	12	3500	792	SPD1TM331E10O00RAXXX
	390	6.3x8	20	3400	936	SPD1TM391E08O00RAXXX
		5.5x9	20	3400	1128	SPD1TM471B09O00RAXXX
	470	6.3x8	20	3500	1128	SPD1TM471E08O00RAXXX
		8x9	15	3550	1128	SPD1TM471F09O00RAXXX
	560	8x11	12	5650	1128	SPD1TM471F11O00RAXXX
		6.3x10	13	3600	1344	SPD1TM561E10O00RAXXX
	680	8x9	15	3600	1344	SPD1TM561F09O00RAXXX
		6.3x11	15	3800	1632	SPD1TM681E11O00RAXXX
	820	8x11	12	3900	1632	SPD1TM681F11O00RAXXX
		8x8	20	3300	1632	SPD1TM681F08O00RAXXX
	1000	8x11	12	4000	1968	SPD1TM821F11O00RAXXX
		8x11	12	4200	2400	SPD1TM102F11O00RAXXX
	1200	10x12	10	5300	2400	SPD1TM102G12O00RAXXX
	1500	10x12	10	5450	2880	SPD1TM122G12O00RAXXX
1800	10x12	10	5500	3600	SPD1TM152G12O00RAXXX	
	8x14	10	4800	3600	SPD1TM152F14O00RAXXX	
2200	10x13	10	5800	4320	SPD1TM182G13O00RAXXX	
3300	10x15	10	6100	5000	SPD1TM222G15O00RAXXX	
16 (18.4)	100	5x7	18	2300	500	SPD1CM101D07O00RAXXX
		6.3x5	22	2200	500	SPD1CM101E05O00RAXXX
	120	5x8	18	2400	500	SPD1CM121D08O00RAXXX
	150	5x8	18	2500	500	SPD1CM151D08O00RAXXX
		6.3x5	27	2300	576	SPD1CM181E05O00RAXXX
	180	5x8	18	2500	576	SPD1CM181D08O00RAXXX
		5x10	18	2700	704	SPD1CM221D10O00RAXXX
	220	6.3x5	25	2800	704	SPD1CM221E05O00RAXXX
		6.3x8	18	2800	704	SPD1CM221E08O00RAXXX
	270	6.3x8	18	2900	864	SPD1CM271E08O00RAXXX
	330	6.3x7	18	3000	1056	SPD1CM331E07O00RAXXX

Conductive Polymer Radial Type

PD series

■ STANDARD RATINGS

VDC (SV)	Cap (μF)	Size DxL(mm)	ESR (mΩ, 20°C, 100kHz) (max.)	Rated ripple current (mA rms/105°C, 100kHz)	Leakage Current (μA)(max.)	Part Number	
16 (18.4)	470	5.5×10	18	3100	1504	SPD1CM471B10O00RAXXX	
		8×9	11	3400	1504	SPD1CM471F09O00RAXXX	
	560	8×11	13	3300	1792	SPD1CM561F11O00RAXXX	
	680	8×11	13	3500	2176	SPD1CM681F11O00RAXXX	
	820	8×13	9	3600	2624	SPD1CM821F13O00RAXXX	
	1000	8×14	10	3700	3200	SPD1CM102F14O00RAXXX	
	1200	10×12	10	4400	3840	SPD1CM122G12O00RAXXX	
	1500	10×12	10	5000	4800	SPD1CM152G12O00RAXXX	
20 (23.0)	33	5×8	40	1900	500	SPD1DM330D08O00RAXXX	
	39	5×8	40	1950	500	SPD1DM390D08O00RAXXX	
	47	5×8	40	2200	500	SPD1DM470D08O00RAXXX	
	56	5×9	40	2100	500	SPD1DM560D09O00RAXXX	
	68	6.3×8	30	2100	500	SPD1DM680E08O00RAXXX	
	82	6.3×8	30	2150	500	SPD1DM820E08O00RAXXX	
	100	6.3×8	30	2200	500	SPD1DM101E08O00RAXXX	
	120	6.3×8	30	2300	500	SPD1DM121E08O00RAXXX	
	150	6.3×10	20	2350	600	SPD1DM151E10O00RAXXX	
	180	8×9	30	2450	720	SPD1DM181F09O00RAXXX	
	220	8×11	20	2550	880	SPD1DM221F11O00RAXXX	
	270	8×11	20	2700	1080	SPD1DM271F11O00RAXXX	
		330	8×11	20	2800	1320	SPD1DM331F11O00RAXXX
			6.3×11	20	2100	1320	SPD1DM331E11O00RAXXX
			10×12	20	2900	1880	SPD1DM471G12O00RAXXX
			8×16	20	3000	1880	SPD1DM471F16O00RAXXX
		470	8×11	20	2400	1880	SPD1DM471F11O00RAXXX
			10×12	20	3100	1880	SPD1DM471G12O00RAXXX
			8×16	20	3200	1880	SPD1DM471F16O00RAXXX
		680	10×15	20	3300	2720	SPD1DM681G15O00RAXXX
		8×14	20	2700	2720	SPD1DM681F14O00RAXXX	
	820	10×18	20	3400	3280	SPD1DM821G18O00RAXXX	
	1000	10×18	20	3900	4000	SPD1DM102G18O00RAXXX	
25 (28.8)	47	5×9	54	2000	500	SPD1EM470D09O00RAXXX	
	56	5×9	54	2100	500	SPD1EM560D09O00RAXXX	
	68	6.3×7	27	2200	500	SPD1EM680E07O00RAXXX	
	82	6.3×7	27	2200	500	SPD1EM820E07O00RAXXX	
	100	6.3×8	27	2600	500	SPD1EM101E08O00RAXXX	
	120	6.3×8	27	2600	600	SPD1EM121E08O00RAXXX	
	150	6.3×10	18	2900	750	SPD1EM151E10O00RAXXX	
	180	6.3×10	18	2900	900	SPD1EM181E10O00RAXXX	
	220	5.5×10	18	1900	1100	SPD1EM221B10O00RAXXX	
	270	8×11	18	3100	1350	SPD1EM271F11O00RAXXX	
	330	8×11	18	3200	1650	SPD1EM331F11O00RAXXX	
		470	8×11	18	3100	2350	SPD1EM471F11O00RAXXX
			10×10	25	2300	2350	SPD1EM471G10O00RAXXX
		560	10×12	18	4200	2800	SPD1EM561G12O00RAXXX
		680	10×12	18	4300	3400	SPD1EM681G12O00RAXXX
		8×14	18	3500	3400	SPD1EM681F14O00RAXXX	
	820	10×12	18	4300	4100	SPD1EM821G12O00RAXXX	
		8×16	18	3700	4100	SPD1EM821F16O00RAXXX	
	1000	10×13	18	4400	5000	SPD1EM102G13O00RAXXX	
35 (40.3)	47	6.3×7	45	2200	500	SPD1VM470E07O00RAXXX	
	56	6.3×7	45	2200	500	SPD1VM560E07O00RAXXX	
	68	6.3×7	45	2300	500	SPD1VM680E07O00RAXXX	
	82	6.3×7	45	2300	574	SPD1VM820E07O00RAXXX	
	100	6.3×8	45	2400	700	SPD1VM101E08O00RAXXX	
	120	6.3×9	45	2500	840	SPD1VM121E09O00RAXXX	
	150	6.3×10	36	2600	1050	SPD1VM151E10O00RAXXX	
		220	8×11	36	2900	1540	SPD1VM221F11O00RAXXX
			6.3×11	36	2700	1540	SPD1VM221E11O00RAXXX
		270	10×12	27	3100	1890	SPD1VM271G12O00RAXXX
		330	10×12	27	3200	2310	SPD1VM331G12O00RAXXX
		470	10×13	18	3300	3290	SPD1VM471G13O00RAXXX
		680	10×16	18	3500	4760	SPD1VM681G16O00RAXXX

Specifications subject to change without notice.

PV series

- Endurance: +125°C 2,000 hours
- High voltage
- Recommended Applications: System Board, Display Card, Small Charger, and intelligent TV
- RoHS Compliant and lead-free



SPECIFICATIONS

Items	Characteristics					
Category Temperature Range	-55~+125°C					
Rated Working Voltage Range	35~100 V _{dc}					
Nominal Capacitance Range	4.7~1000μF					
Capacitance Tolerance	±20%(M) (at 20°C, 120Hz)					
DC Leakage Current	I 0.2CV or 500μA, whichever is greater. Where, I:Max.leakage current (μA), C:Nominal capacitance (μF), V: Rated voltage (V) (at 20°C after 2 minutes)					
Dissipation Factor (tan δ)	Rated Voltage(V _{dc})	35	50	63	80	100
	tan δ (max.)	0.12				0.15
ESR(100kHz, 20°C)	Value in characteristics table					
Temperature Characteristic (Impedance Ratio at 100kHz)	Z(+125°C)/Z(+20°C) 1.25 Z(-55°C)/Z(+20°C) 1.25					
Endurance	After applying rated voltage for 2,000 hours at 125°C, the capacitors shall meet the following requirements.					
	Appearance	No significant damage				
	Capacitance Change	±20% of the initial value				
	D.F. (tan δ)	150% of the initial specified value				
	ESR	150% of the initial specified value				
Leakage Current	The initial specified value					
	Humidity Test					
After subjecting to 90%~95% RH for 2,000 hours at 60°C without voltage applied, the capacitors shall meet the specified values for the Endurance characteristics listed above.						
Surge Test	After subjecting to 1,000 cycles each consisting of charge with the surge voltage specified at normal temperature for 30 seconds through a protective resistor and discharge for 5 minutes 30 seconds, the capacitors shall meet the following requirements.					
	Appearance	No significant damage				
	Capacitance Change	±20% of the initial value				
	D.F. (tan δ)	150% of the initial specified value				
	ESR	150% of the initial specified value				
Leakage Current	The initial specified value					

Conductive Polymer Radial Type

DIMENSIONS[mm]

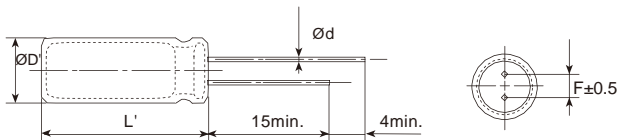

øD	5	5.5	6.3	8	10
ød	0.5	0.5	0.5	0.6	0.6
F	2.0	2.5	2.5	3.5	5.0
øD'	øD-0.1~+0.5				
L'	L+1.0max.		L-0.5~+1		

PART NUMBERING SYSTEM

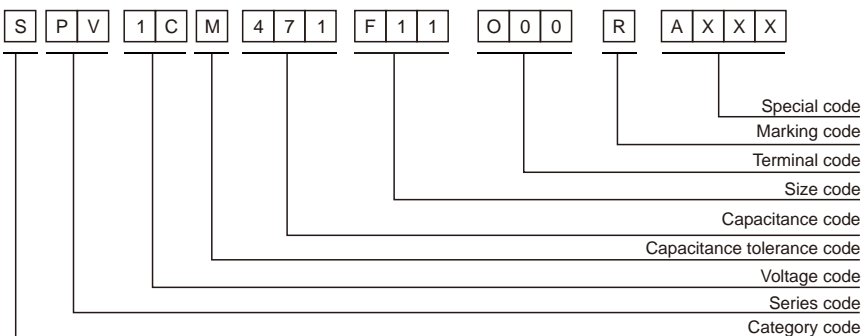

PV series

■ STANDARD RATINGS

VDC (SV)	Cap (μF)	Size DxL(mm)	ESR (mΩ, 20°C, 100kHz) (max.)	Rated ripple current (mA rms/125°C, 100kHz)	Leakage Current (μA)(max.)	Part Number	
35 (40.3)	4.7	5x8	90	500	500	SPV1VM4R7D08O00RAXXX	
	10	5x8	90	500	500	SPV1VM100D08O00RAXXX	
	15	5x8	90	500	500	SPV1VM150D08O00RAXXX	
	22	5x9	150	500	500	SPV1VM220D09O00RAXXX	
	33	5x9	75	600	500	SPV1VM330D09O00RAXXX	
	39	5x9	75	600	500	SPV1VM390D09O00RAXXX	
	47	6.3x7	75	600	500	SPV1VM470E07O00RAXXX	
	56	6.3x7	75	600	500	SPV1VM560E07O00RAXXX	
	68	6.3x7	75	600	500	SPV1VM680E07O00RAXXX	
	82	6.3x7	75	600	574	SPV1VM820E07O00RAXXX	
		6.3x8	75	700	700	SPV1VM101E08O00RAXXX	
		6.3x10	60	700	700	SPV1VM101E10O00RAXXX	
		8x11	60	700	700	SPV1VM101F11O00RAXXX	
		120	6.3x10	60	700	840	SPV1VM121E10O00RAXXX
		150	6.3x10	60	700	1050	SPV1VM151E10O00RAXXX
		220	8x11	60	800	1540	SPV1VM221F11O00RAXXX
			10x12	45	800	1540	SPV1VM221G12O00RAXXX
		270	10x12	45	900	1890	SPV1VM271G12O00RAXXX
		330	10x12	45	900	2310	SPV1VM331G12O00RAXXX
		470	10x13	30	900	3290	SPV1VM471G13O00RAXXX
	560	10x14	30	900	3920	SPV1VM561G14O00RAXXX	
	680	10x16	30	1000	4760	SPV1VM681G16O00RAXXX	
	820	10x18	30	1000	5000	SPV1VM821G18O00RAXXX	
	1000	10x18	30	1100	5000	SPV1VM102G18O00RAXXX	
50 (57.5)	4.7	5x8	90	400	500	SPV1HM4R7D08O00RAXXX	
	10	6.3x7	52	500	500	SPV1HM100E07O00RAXXX	
	15	5x8	105	500	500	SPV1HM100D08O00RAXXX	
	22	6.3x7	60	500	500	SPV1HM220E07O00RAXXX	
	33	6.3x7	60	600	500	SPV1HM330E07O00RAXXX	
	47	6.3x8	52	600	500	SPV1HM470E08O00RAXXX	
	56	6.3x8	52	600	560	SPV1HM560E08O00RAXXX	
	68	6.3x10	45	600	680	SPV1HM680E10O00RAXXX	
	100	8x11	45	600	1000	SPV1HM101F11O00RAXXX	
		8x9	60	600	1000	SPV1HM101F09O00RAXXX	
		150	10x12	45	700	1500	SPV1HM151G12O00RAXXX
		220	10x12	45	800	2200	SPV1HM221G12O00RAXXX
		270	10x13	30	800	2700	SPV1HM271G13O00RAXXX
		330	10x15	30	800	3300	SPV1HM331G15O00RAXXX
		440	10x18	30	900	4400	SPV1HM441G18O00RAXXX
		470	10x18	30	900	4700	SPV1HM471G18O00RAXXX
63 (72.5)	4.7	6.3x8	90	400	500	SPV1JM4R7E08O00RAXXX	
	6.8	6.3x8	90	400	500	SPV1JM6R8E08O00RAXXX	
	10	6.3x5	90	400	500	SPV1JM100E05O00RAXXX	
	33	6.3x8	45	500	500	SPV1JM330E08O00RAXXX	
	39	6.3x8	45	500	500	SPV1JM390E08O00RAXXX	
	68	8x11	45	600	857	SPV1JM680F11O00RAXXX	
	82	8x11	45	600	1033	SPV1JM820F11O00RAXXX	
	100	10x12	45	600	1260	SPV1JM101G12O00RAXXX	
	150	10x12	45	700	1890	SPV1JM151G12O00RAXXX	
	180	10x13	30	700	2268	SPV1JM181G13O00RAXXX	
	220	10x15	30	700	2772	SPV1JM221G15O00RAXXX	
	270	10x17	30	800	3402	SPV1JM271G17O00RAXXX	
	330	10x18	30	800	4158	SPV1JM331G18O00RAXXX	
80 (92.0)	4.7	6.3x8	90	400	500	SPV1BM4R7E08O00RAXXX	
	6.8	6.3x8	90	400	500	SPV1BM6R8E08O00RAXXX	
	22	6.3x10	90	400	500	SPV1BM220E10O00RAXXX	
	33	8x11	52	500	528	SPV1BM330F11O00RAXXX	
	47	10x12	52	500	752	SPV1BM470G12O00RAXXX	
	68	10x12	52	500	1088	SPV1BM680G12O00RAXXX	
100	10x14	52	600	1600	SPV1BM101G14O00RAXXX		
100 (115.0)	4.7	6.3x8	180	400	500	SPV1KM4R7E08O00RAXXX	
	6.8	6.3x8	180	400	500	SPV1KM6R8E08O00RAXXX	
	10	6.3x10	75	400	500	SPV1KM100E10O00RAXXX	
		8x11	75	400	500	SPV1KM100F11O00RAXXX	
	15	8x11	75	400	500	SPV1KM150F11O00RAXXX	
	22	10x12	52	400	500	SPV1KM220G12O00RAXXX	
	33	10x14	52	400	660	SPV1KM330G14O00RAXXX	
47	10x16	52	400	940	SPV1KM470G16O00RAXXX		

Specifications subject to change without notice.

PH series

- Endurance: +105°C 2,000 hours
- High Capacitance
- Recommended Applications: Charger. Ripple current can be applied.
- RoHS Compliant and lead-free

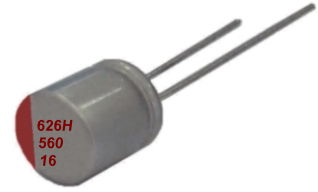

Conductive Polymer
Radial Type

SPECIFICATIONS

Items	Characteristics							
Category Temperature Range	-55~+105°C							
Rated Working Voltage Range	6.3~25 V _{dc}							
Nominal Capacitance Range	10~2200μF							
Capacitance Tolerance	±20%(M) (at 20°C,120Hz)							
DC Leakage Current	I 0.2CV or 500μA, whichever is greater. Where, I:Max.leakage current (μA),C:Nominal capacitance (μF),V: Rated voltage (V) (at 20°C after 2 minutes)							
Dissipation Factor (tan δ)	Rated Voltage(V _{dc})	6.3	6.8	7.5	10	16	20	25
	tan δ (max.)	0.08			0.12			
ESR(100kHz,20°C)	Value in characteristics table							
Temperature Characteristic (Impedance Ratio at 100kHz)	Z(+105°C)/Z(+20°C) 1.25 Z(-55°C)/Z(+20°C) 1.25							
Endurance	After applying rated voltage for 2,000 hours at 105°C,the capacitors shall meet the following requirements.							
	Appearance	No significant damage						
	Capacitance Change	±20% of the initial value						
	D.F. (tan δ)	200% of the initial specified value						
	ESR	200% of the initial specified value						
Leakage Current	The initial specified value							
Humidity Test	After subjecting to 90~95% RH for 2,000 hours at 60°C without voltage applied, the capacitors shall meet the requirement as surge test.							
Surge Test	After subjecting to 1,000 cycles each consisting of charge with the surge voltage specified at normal temperature for 30 seconds through a protective resistor and discharge for 5 minutes 30 seconds, the capacitors shall meet the following requirements.							
	Appearance	No significant damage						
	Capacitance Change	±20% of the initial value						
	D.F. (tan δ)	150% of the initial specified value						
	ESR	150% of the initial specified value						
Leakage Current	The initial specified value							

DIMENSIONS[mm]

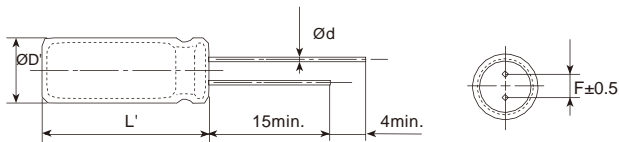

øD	5	5.5	6.3	8	10
ød	0.5	0.5	0.5	0.6	0.6
F	2.0	2.5	2.5	3.5	5.0
øD'	øD-0.1~+0.5				
L'	L+1.0max.			L-0.5~+1	

PART NUMBERING SYSTEM

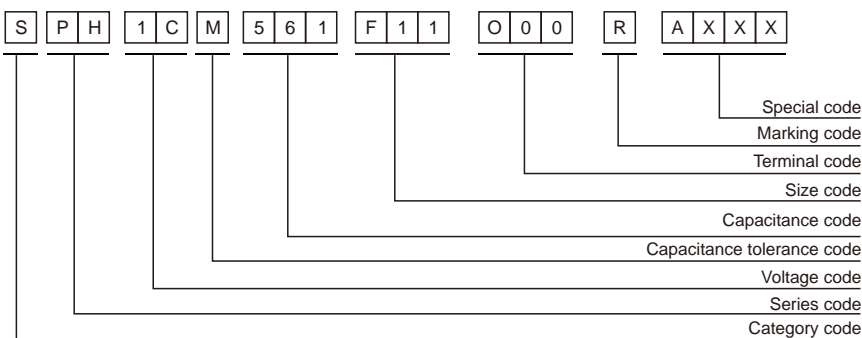

PH series

■ STANDARD RATINGS

VDC (SV)	Cap (μF)	Size DxL(mm)	ESR (mΩ, 20°C, 100kHz) (max.)	Rated ripple current (mA rms/105°C, 100kHz)	Leakage Current (μA)(max.)	Part Number	
6.3 (7.2)	220	5x7	16	4000	500	SPH0JM221D07O00RAXXX	
	270	5x7	16	4300	500	SPH0JM271D07O00RAXXX	
	330	5x8	16	4600	500	SPH0JM331D08O00RAXXX	
		6.3x5	20	3600	500	SPH0JM331E05O00RAXXX	
	390	6.3x8	12	4600	500	SPH0JM331E08O00RAXXX	
		5x9	16	4700	500	SPH0JM391D09O00RAXXX	
	470	5x10	16	4900	592	SPH0JM471D10O00RAXXX	
		5.5x9	16	4700	592	SPH0JM471B09O00RAXXX	
		6.3x7	16	4400	592	SPH0JM471E07O00RAXXX	
		6.3x8	12	5000	592	SPH0JM471E08O00RAXXX	
	500	5x9	16	4700	630	SPH0JM501D09O00RAXXX	
		5.5x9	16	4900	706	SPH0JM561B09O00RAXXX	
	560	6.3x8	16	5500	706	SPH0JM561E08O00RAXXX	
		6.3x9	16	5800	857	SPH0JM681E09O00RAXXX	
	680	5.5x9	16	5500	857	SPH0JM681B09O00RAXXX	
		8x9	16	5200	857	SPH0JM681F09O00RAXXX	
	820	6.3x9	16	5800	1033	SPH0JM821E09O00RAXXX	
		8x9	12	5400	1033	SPH0JM821F09O00RAXXX	
	1000	6.3x10	8	5900	1260	SPH0JM102E10O00RAXXX	
		8x9	9	5500	1260	SPH0JM102F09O00RAXXX	
8x11		8	5900	1260	SPH0JM102F11O00RAXXX		
1200	8x11	8	6000	1512	SPH0JM122F11O00RAXXX		
	8x11	8	6200	1890	SPH0JM152F11O00RAXXX		
1500	10x12	8	6300	1890	SPH0JM152G12O00RAXXX		
	10x10	8	6300	2268	SPH0JM182G10O00RAXXX		
1800	8x14	8	6500	2772	SPH0JM222F14O00RAXXX		
	10x12	8	6600	2772	SPH0JM222G12O00RAXXX		
6.8 (7.8)	220	5x7	18	3500	500	SPH0CM221D07O00RAXXX	
	270	5x7	18	3800	500	SPH0CM271D07O00RAXXX	
		6.3x8	18	4100	500	SPH0CM271E08O00RAXXX	
	330	5x8	18	4000	500	SPH0CM331D08O00RAXXX	
		6.3x5	23	3300	500	SPH0CM331E05O00RAXXX	
	390	6.3x7	18	3600	500	SPH0CM331E07O00RAXXX	
		5x9	18	4100	530	SPH0CM391D09O00RAXXX	
	470	5x9	18	4300	639	SPH0CM471D09O00RAXXX	
		6.3x7	18	3900	639	SPH0CM471E07O00RAXXX	
	560	6.3x8	18	4700	762	SPH0CM561E08O00RAXXX	
	680	6.3x9	18	5000	925	SPH0CM681E09O00RAXXX	
	820	6.3x9	18	5100	1115	SPH0CM821E09O00RAXXX	
	1000	6.3x11	11	5400	1360	SPH0CM102E11O00RAXXX	
8x11		9	5400	1360	SPH0CM102F11O00RAXXX		
7 (8.1)	150	5x6	27	1600	500	SPH0QM151D06O00RAXXX	
	220	5x7	18	3400	500	SPH0QM221D07O00RAXXX	
	270	5x8	18	3600	500	SPH0QM271D08O00RAXXX	
	330	5x9	18	3800	500	SPH0QM331D09O00RAXXX	
	470	6.3x8	18	4000	658	SPH0QM471E08O00RAXXX	
		5.5x9	18	3800	658	SPH0QM471B09O00RAXXX	
	560	6.3x8	18	4200	784	SPH0QM561E08O00RAXXX	
	680	6.3x9	11	4400	952	SPH0QM681E09O00RAXXX	
	820	6.3x10	11	4700	1148	SPH0QM821E10O00RAXXX	
8x9		11	4800	1148	SPH0QM821F09O00RAXXX		
7.5 (8.6)	220	5x7	18	3300	500	SPH0AM221D07O00RAXXX	
	270	5x8	18	3500	500	SPH0AM271D08O00RAXXX	
	330	5x9	18	3700	500	SPH0AM331D09O00RAXXX	
	390	5x9	18	3700	585	SPH0AM391D09O00RAXXX	
		6.3x7	23	3400	705	SPH0AM471E07O00RAXXX	
	470	5.5x9	18	3700	705	SPH0AM471B09O00RAXXX	
		5x9	18	3700	705	SPH0AM471B09O00RAXXX	
		5.5x8	23	3300	705	SPH0AM471B08O00RAXXX	
	500	5.5x9	18	3800	750	SPH0AM501B09O00RAXXX	
		6.3x8	18	4100	840	SPH0AM561E08O00RAXXX	
	680	6.3x9	11	4300	1020	SPH0AM681E09O00RAXXX	
	820	6.3x10	11	4600	1230	SPH0AM821E10O00RAXXX	
		8x9	11	4800	1230	SPH0AM821F09O00RAXXX	
	1000	8x11	11	4900	1500	SPH0AM102F11O00RAXXX	
		6.3x11	11	4700	1500	SPH0AM102E11O00RAXXX	
		1200	8x11	11	5000	1800	SPH0AM122F11O00RAXXX
			6.8x11	11	4800	1800	SPH0AM122Q11O00RAXXX
	1500	8x11	11	5100	2250	SPH0AM152F11O00RAXXX	
		6.8x13	11	5000	2250	SPH0AM152Q13O00RAXXX	
	1800	8x14	11	5400	2700	SPH0AM182F14O00RAXXX	
2200	10x12	11	6000	3300	SPH0AM222G12O00RAXXX		
10 (11.5)	47	5x7	28	2500	500	SPH1AM470D07O00RAXXX	
	56	5x7	28	2500	500	SPH1AM560D07O00RAXXX	
	68	5x7	28	2600	500	SPH1AM680D07O00RAXXX	

PH series

■ STANDARD RATINGS

VDC (SV)	Cap (μF)	Size DxL(mm)	ESR (mΩ, 20°C, 100kHz) (max.)	Rated ripple current (mArms/105°C, 100kHz)	Leakage Current (μA)(max.)	Part Number
10 (11.5)	82	5x7	28	2700	500	SPH1AM820D07O00RAXXX
	100	5x7	28	2700	500	SPH1AM101D07O00RAXXX
		6.3x5	24	2600	500	SPH1AM101E05O00RAXXX
	150	5x7	16	2800	500	SPH1AM151D07O00RAXXX
	180	6.3x7	16	3200	500	SPH1AM181E07O00RAXXX
		5x9	16	3200	500	SPH1AM221D09O00RAXXX
	220	6.3x5	20	3200	500	SPH1AM221E05O00RAXXX
		6.3x8	12	3600	500	SPH1AM221E08O00RAXXX
	270	6.3x8	16	3500	540	SPH1AM271E08O00RAXXX
		6.3x8	16	3700	660	SPH1AM331E08O00RAXXX
	330	8x9	12	3900	660	SPH1AM331F09O00RAXXX
		6.3x10	9	4000	660	SPH1AM331E10O00RAXXX
	390	6.3x8	16	3900	780	SPH1AM391E08O00RAXXX
		5.5x9	16	3900	940	SPH1AM471B09O00RAXXX
	470	6.3x8	16	3900	940	SPH1AM471E08O00RAXXX
		8x9	12	4000	940	SPH1AM471F09O00RAXXX
	560	8x11	9	6400	940	SPH1AM471F11O00RAXXX
		8x9	12	4100	1120	SPH1AM561F09O00RAXXX
	680	6.3x10	10	4100	1120	SPH1AM561E10O00RAXXX
		8x11	9	4400	1360	SPH1AM681F11O00RAXXX
	820	8x8	16	3700	1360	SPH1AM681F08O00RAXXX
		8x11	9	4600	1640	SPH1AM821F11O00RAXXX
	1000	8x11	9	4800	2000	SPH1AM102F11O00RAXXX
		10x12	8	6000	2000	SPH1AM102G12O00RAXXX
1200	8x12	8	5100	2400	SPH1AM122F12O00RAXXX	
	10x12	8	6200	2400	SPH1AM122G12O00RAXXX	
1500	10x12	8	6300	3000	SPH1AM152G12O00RAXXX	
	8x14	8	5500	3000	SPH1AM152F14O00RAXXX	
1800	10x13	8	6600	3600	SPH1AM182G13O00RAXXX	
2200	10x15	8	7000	4400	SPH1AM222G15O00RAXXX	
12 (13.8)	220	4x10	14	2200	528	SPH1TM221C10O00RAXXX
	330	5.5x9	18	3300	792	SPH1TM331B09O00RAXXX
		6.3x8	18	3300	792	SPH1TM331E08O00RAXXX
	470	5x10	18	3300	792	SPH1TM331D10O00RAXXX
		5.5x9	18	3400	1128	SPH1TM471B09O00RAXXX
	560	6.3x9	18	3600	1128	SPH1TM471E09O00RAXXX
		6.3x10	14	3600	1344	SPH1TM561E10O00RAXXX
	680	6.3x11	14	3800	1632	SPH1TM681E11O00RAXXX
		8x10	14	3900	1632	SPH1TM681F10O00RAXXX
	820	8x11	11	4000	1968	SPH1TM821F11O00RAXXX
	1000	8x12	11	4200	2400	SPH1TM102F12O00RAXXX
	1200	8x14	11	4600	2880	SPH1TM122F14O00RAXXX
	1500	8x16	11	5000	3600	SPH1TM152F16O00RAXXX
	16 (18.4)	22	5x9	64	1800	500
47		5x7	16	2300	500	SPH1CM470D07O00RAXXX
56		5x7	16	2400	500	SPH1CM560D07O00RAXXX
68		5x7	16	2400	500	SPH1CM680D07O00RAXXX
82		5x8	16	2500	500	SPH1CM820D08O00RAXXX
		5x7	16	2500	500	SPH1CM101D07O00RAXXX
100		6.3x5	20	2400	500	SPH1CM101E05O00RAXXX
		6.3x8	16	3200	500	SPH1CM101E08O00RAXXX
120		5x8	16	2700	500	SPH1CM121D08O00RAXXX
150		5x8	16	2700	500	SPH1CM151D08O00RAXXX
		5x8	16	2800	576	SPH1CM181D08O00RAXXX
180		6.3x7	12	2800	576	SPH1CM181E07O00RAXXX
		5x10	16	2900	704	SPH1CM221D10O00RAXXX
220		6.3x8	16	3100	704	SPH1CM221E08O00RAXXX
		6.3x10	12	3300	704	SPH1CM221E10O00RAXXX
270		5.5x9	16	3100	864	SPH1CM271B09O00RAXXX
		6.3x8	16	3100	864	SPH1CM271E08O00RAXXX
330		8x9	16	3300	864	SPH1CM271F09O00RAXXX
		5.5x9	16	3300	1056	SPH1CM331B09O00RAXXX
470		6.3x9	16	3300	1056	SPH1CM331E09O00RAXXX
		6.3x10	12	3500	1056	SPH1CM331E10O00RAXXX
560		6.3x11	12	3400	1504	SPH1CM471E11O00RAXXX
		8x11	12	5200	1504	SPH1CM471F11O00RAXXX
680		8x9	10	4700	1504	SPH1CM471F09O00RAXXX
		8x11	12	3600	1792	SPH1CM561F11O00RAXXX
820		8x13	12	3700	1792	SPH1CM561F13O00RAXXX
		10x12	9	4000	1792	SPH1CM561G12O00RAXXX
1000		8x11	12	3900	2176	SPH1CM681F11O00RAXXX
		10x12	9	4100	2176	SPH1CM681G12O00RAXXX
1200		8x13	8	4000	2624	SPH1CM821F13O00RAXXX
		10x12	9	4300	2624	SPH1CM821G12O00RAXXX
1500		10x12	9	4600	3200	SPH1CM102G12O00RAXXX
		10x15	9	4900	3840	SPH1CM122G15O00RAXXX

Conductive Polymer Radial Type

PH series

■ STANDARD RATINGS

VDC (SV)	Cap (µF)	Size DxL(mm)	ESR (mΩ, 20°C, 100kHz) (max.)	Rated ripple current (mArms/105°C, 100kHz)	Leakage Current (µA)(max.)	Part Number	
16 (18.4)	1500	10x12	9	5500	4800	SPH1CM152G12O00RAXXX	
	1800	10x18	9	6300	4800	SPH1CM152G18O00RAXXX	
		10x14	9	6200	5000	SPH1CM182G14O00RAXXX	
		10x17	9	6600	5000	SPH1CM222G17O00RAXXX	
		10x15	9	6300	5000	SPH1CM222G15O00RAXXX	
20 (23.0)	33	5x8	36	2000	500	SPH1DM330D08O00RAXXX	
	39	5x8	36	2000	500	SPH1DM390D08O00RAXXX	
	47	5x8	36	2300	500	SPH1DM470D08O00RAXXX	
	56	5x9	36	2200	500	SPH1DM560D09O00RAXXX	
	68	6.3x8	27	2200	500	SPH1DM680E08O00RAXXX	
	82	6.3x8	27	2300	500	SPH1DM820E08O00RAXXX	
	100	6.3x8	27	2300	500	SPH1DM101E08O00RAXXX	
	120	6.3x8	27	2400	500	SPH1DM121E08O00RAXXX	
	150	6.3x10	18	2500	600	SPH1DM151E10O00RAXXX	
	180	8x9	27	2600	720	SPH1DM181F09O00RAXXX	
	220	8x11	18	2700	880	SPH1DM221F11O00RAXXX	
	270	8x11	18	2800	1080	SPH1DM271F11O00RAXXX	
	470	8x11	18	2900	1320	SPH1DM331F11O00RAXXX	
		6.3x11	18	2200	1320	SPH1DM331E11O00RAXXX	
		10x12	18	3000	1880	SPH1DM471G12O00RAXXX	
		8x16	18	3200	1880	SPH1DM471F16O00RAXXX	
	560	8x11	18	2500	1880	SPH1DM471F11O00RAXXX	
		10x12	18	3300	2240	SPH1DM561G12O00RAXXX	
		8x16	18	3400	2240	SPH1DM561F16O00RAXXX	
	680	10x15	18	3500	2720	SPH1DM681G15O00RAXXX	
		8x14	18	2800	2720	SPH1DM681F14O00RAXXX	
		10x18	18	3600	3280	SPH1DM821G18O00RAXXX	
	1000	10x18	18	4100	4000	SPH1DM102G18O00RAXXX	
	25 (28.8)	10	5x8	56	2000	500	SPH1EM100D08O00RAXXX
		22	5x9	48	2000	500	SPH1EM220D09O00RAXXX
		33	5x9	48	2100	500	SPH1EM330D09O00RAXXX
		39	5x8	48	2100	500	SPH1EM390D08O00RAXXX
47		5x9	48	2200	500	SPH1EM470D09O00RAXXX	
56		5x9	48	2300	500	SPH1EM560D09O00RAXXX	
68		6.3x7	24	2400	500	SPH1EM680E07O00RAXXX	
82		6.3x7	24	2400	500	SPH1EM820E07O00RAXXX	
		6.3x8	24	2800	500	SPH1EM101E08O00RAXXX	
		6.3x10	16	3200	500	SPH1EM101E10O00RAXXX	
		8x11	16	3400	500	SPH1EM101F11O00RAXXX	
120		6.3x8	24	2800	600	SPH1EM121E08O00RAXXX	
150		6.3x10	16	3200	750	SPH1EM151E10O00RAXXX	
180		6.3x10	16	3200	900	SPH1EM181E10O00RAXXX	
		8x9	24	2800	900	SPH1EM181F09O00RAXXX	
		8x11	16	3400	1100	SPH1EM221F11O00RAXXX	
220		10x12	16	4000	1100	SPH1EM221G12O00RAXXX	
		5.5x10	16	2100	1100	SPH1EM221B10O00RAXXX	
		8x11	16	3400	1350	SPH1EM271F11O00RAXXX	
330		8x11	16	3500	1650	SPH1EM331F12O00RAXXX	
		10x12	16	4300	1650	SPH1EM331G12O00RAXXX	
		10x10	20	3200	1650	SPH1EM331G10O00RAXXX	
		10x12	16	4600	2350	SPH1EM471G12O00RAXXX	
470		8x16	16	3900	2350	SPH1EM471F16O00RAXXX	
		8x11	16	3400	2350	SPH1EM471F11O00RAXXX	
		10x10	20	3200	2350	SPH1EM471G10O00RAXXX	
560		10x12	16	4600	2800	SPH1EM561G12O00RAXXX	
		8x12	16	3500	2800	SPH1EM561F12O00RAXXX	
		10x15	16	4900	3400	SPH1EM681G15O00RAXXX	
680		10x12	16	4700	3400	SPH1EM681G12O00RAXXX	
		8x14	16	3900	3400	SPH1EM681F14O00RAXXX	
		10x18	16	5100	4100	SPH1EM821G18O00RAXXX	
820		10x12	16	4700	4100	SPH1EM821G12O00RAXXX	
		10x18	16	5100	5000	SPH1EM102G18O00RAXXX	

Specifications subject to change without notice.

PT series

- Endurance: +125°C 2,000 hours
- Long Life, High Temperature Resistance
- Recommended Applications: Lamps Power, LED Power, Service Equipment
- RoHS Compliant and lead-free



SPECIFICATIONS

Items	Characteristics							
Category Temperature Range	-55~+125°C							
Rated Working Voltage Range	6.3~25 V _{dc}							
Nominal Capacitance Range	22~5600μF							
Capacitance Tolerance	±20%(M) (at 20°C, 120Hz)							
DC Leakage Current	I 0.2CV or 500μA, whichever is greater. Where, I: Max. leakage current (μA), C: Nominal capacitance (μF), V: Rated voltage (V) (at 20°C after 2 minutes)							
Dissipation Factor (tan δ)	Rated Voltage (V _{dc})	6.3	6.8	7.5	10	16	25	
	tan δ (max.)	0.08				0.12		(at 20°C, 120Hz)
ESR(100kHz, 20°C)	Value in characteristics table							
Temperature Characteristic (Impedance Ratio at 100kHz)	Z(+125°C)/Z(+20°C) 1.25 Z(-55°C)/Z(+20°C) 1.25							
Endurance	After applying rated voltage for 2,000 hours at 125°C, the capacitors shall meet the following requirements.							
	Appearance	No significant damage						
	Capacitance Change	±20% of the initial value						
	D.F. (tan δ)	200% of the initial specified value						
	ESR	200% of the initial specified value						
Humidity Test	After subjecting to 90~95% RH for 2,000 hours at 60°C without voltage applied, the capacitors shall meet the requirement as surge test.							
	After subjecting to 1,000 cycles each consisting of charge with the surge voltage specified at normal temperature for 30 seconds through a protective resistor and discharge for 5 minutes 30 seconds, the capacitors shall meet the following requirements.							
	Appearance	No significant damage						
	Capacitance Change	±20% of the initial value						
	D.F. (tan δ)	150% of the initial specified value						
Surge Test	ESR	150% of the initial specified value						
	Leakage Current	The initial specified value						

*Note: If any doubt arises, measure the leakage current after the following voltage treatment.
Voltage treatment: DC rated voltage is applied to the capacitors for 120 minutes at 105°C.

DIMENSIONS[mm]

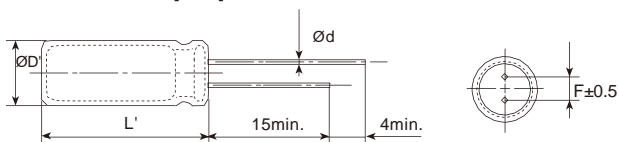

øD	5	5.5	6.3	8	10
ød	0.5	0.5	0.5	0.6	0.6
F	2.0	2.5	2.5	3.5	5.0
øD'	øD-0.1~+0.5				
L'	L+1.0max.		L-0.5~-+1		

PART NUMBERING SYSTEM

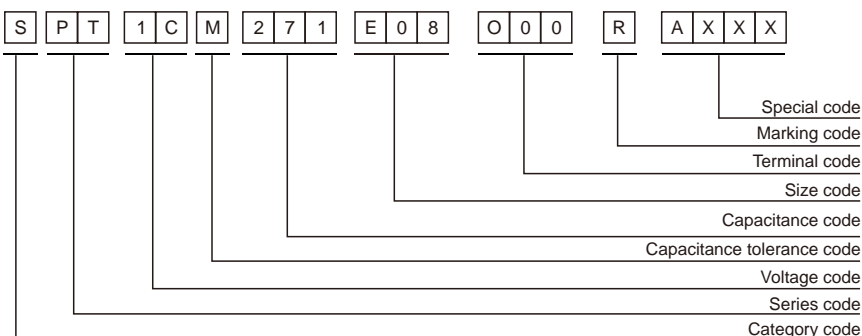

Conductive Polymer Radial Type

PT series

■ STANDARD RATINGS

VDC (SV)	Cap (μF)	Size DxL(mm)	ESR (mΩ, 20°C, 100kHz) (max.)	Rated ripple current (mArms/125°C, 100kHz)	Leakage Current (μA)(max.)	Part Number
6.3 (7.2)	220	5x7	30	1000	500	SPT0JM221D07O00RAXXX
	270	5x7	30	1100	500	SPT0JM271D07O00RAXXX
	330	5x8	30	1200	500	SPT0JM331D08O00RAXXX
		6.3x5	37	900	500	SPT0JM331E05O00RAXXX
	390	6.3x8	22	1200	500	SPT0JM331E08O00RAXXX
		5x9	30	1200	500	SPT0JM391D09O00RAXXX
	470	5x10	30	1200	592	SPT0JM471D10O00RAXXX
		5.5x9	30	1200	592	SPT0JM471B09O00RAXXX
		6.3x7	30	1100	592	SPT0JM471E07O00RAXXX
		6.3x8	22	1300	592	SPT0JM471E08O00RAXXX
	560	6.3x7	30	1200	706	SPT0JM561E07O00RAXXX
		6.3x8	30	1400	706	SPT0JM561E08O00RAXXX
		5.5x9	30	1200	706	SPT0JM561B09O00RAXXX
	680	6.3x9	30	1500	857	SPT0JM681E09O00RAXXX
		5.5x9	30	1400	857	SPT0JM681B09O00RAXXX
		8x9	30	1300	857	SPT0JM681F09O00RAXXX
	820	6.3x9	30	1500	1033	SPT0JM821E09O00RAXXX
		8x9	22	1400	1033	SPT0JM821F09O00RAXXX
		6.3x10	15	1500	1260	SPT0JM102E10O00RAXXX
	1000	8x9	18	1400	1260	SPT0JM102F09O00RAXXX
8x11		15	1500	1260	SPT0JM102F11O00RAXXX	
1200	8x11	15	1500	1512	SPT0JM122F11O00RAXXX	
1500	8x11	15	1600	1890	SPT0JM152F11O00RAXXX	
1800	10x12	15	1600	1890	SPT0JM152G12O00RAXXX	
2200	10x10	15	1600	2268	SPT0JM182G10O00RAXXX	
3300	8x14	15	1700	2772	SPT0JM222F14O00RAXXX	
	10x12	15	1700	2772	SPT0JM222G12O00RAXXX	
4700	10x14	15	1700	4158	SPT0JM332G14O00RAXXX	
5600	10x17	15	1800	5000	SPT0JM472G17O00RAXXX	
5600	10x18	15	1800	5000	SPT0JM562G18O00RAXXX	
6.8 (7.8)	220	5x7	28	900	500	SPT0CM221D07O00RAXXX
	270	5x7	28	1000	500	SPT0CM271D07O00RAXXX
	330	5x8	28	1100	500	SPT0CM331D08O00RAXXX
		6.3x5	35	900	500	SPT0CM331E05O00RAXXX
	470	5x9	28	1200	639	SPT0CM471D09O00RAXXX
		6.3x7	28	1100	639	SPT0CM471E07O00RAXXX
	560	6.3x8	28	1300	762	SPT0CM561E08O00RAXXX
	680	6.3x9	28	1400	925	SPT0CM681E09O00RAXXX
	820	6.3x9	28	1400	1115	SPT0CM821E09O00RAXXX
	1000	6.3x11	17	1500	1360	SPT0CM102F11O00RAXXX
8x11		14	1500	1360	SPT0CM102F11O00RAXXX	
7 (8.1)	220	5x7	28	900	500	SPT0QM221D07O00RAXXX
	270	5x8	28	1000	500	SPT0QM271D08O00RAXXX
	330	5x9	28	1000	500	SPT0QM331D09O00RAXXX
	470	6.3x7	28	1100	658	SPT0QM471E07O00RAXXX
		5.5x9	28	1000	658	SPT0QM471B09O00RAXXX
	560	6.3x8	28	1200	784	SPT0QM561E08O00RAXXX
	680	6.3x9	17	1200	952	SPT0QM681E09O00RAXXX
	820	6.3x10	17	1300	1148	SPT0QM821E10O00RAXXX
820	8x9	17	1300	1148	SPT0QM821F09O00RAXXX	
7.5 (8.6)	220	5x7	28	900	500	SPT0AM221D07O00RAXXX
	270	5x7	28	900	500	SPT0AM271D07O00RAXXX
	330	5x9	28	1000	500	SPT0AM331D09O00RAXXX
	390	5x9	28	1000	585	SPT0AM391D09O00RAXXX
	470	6.3x7	35	900	705	SPT0AM471E07O00RAXXX
		5.5x9	28	1000	705	SPT0AM471B09O00RAXXX
	500	5.5x9	28	1000	750	SPT0AM501B09O00RAXXX
	560	6.3x8	28	1100	840	SPT0AM561E08O00RAXXX
	680	6.3x9	17	1200	1020	SPT0AM681E09O00RAXXX
	820	6.3x10	17	1300	1230	SPT0AM821E10O00RAXXX
8x9		17	1300	1230	SPT0AM821F09O00RAXXX	
1200	8x11	17	1440	1800	SPT0AM122F11O00RAXXX	
10 (11.5)	47	5x7	52	600	500	SPT1AM470D07O00RAXXX
	56	5x7	52	600	500	SPT1AM560D07O00RAXXX
	68	5x7	52	600	500	SPT1AM680D07O00RAXXX
	82	5x7	52	700	500	SPT1AM820D07O00RAXXX
	100	5x7	52	700	500	SPT1AM101D07O00RAXXX
	120	5x7	30	700	500	SPT1AM121D07O00RAXXX
	150	5x7	30	700	500	SPT1AM151D07O00RAXXX
	180	5x8	30	800	500	SPT1AM181D08O00RAXXX
	220	5x9	30	800	500	SPT1AM221D09O00RAXXX
		6.3x8	22	900	500	SPT1AM221E08O00RAXXX
	270	6.3x8	30	900	540	SPT1AM271E08O00RAXXX
		6.3x8	30	900	660	SPT1AM331E08O00RAXXX
	330	8x9	22	1000	660	SPT1AM331F09O00RAXXX
	390	6.3x8	30	1000	780	SPT1AM391E08O00RAXXX

PT series

■ STANDARD RATINGS

VDC (SV)	Cap (μF)	Size DxL(mm)	ESR (mΩ, 20°C, 100kHz) (max.)	Rated ripple current (mA rms/125°C, 100kHz)	Leakage Current (μA)(max.)	Part Number
10 (11.5)	470	5.5x9	30	1000	940	SPT1AM471B09000RAXXX
		6.3x8	30	1000	940	SPT1AM471E08000RAXXX
		8x9	22	1000	940	SPT1AM471F09000RAXXX
		8x11	18	1600	940	SPT1AM471F11000RAXXX
	560	6.3x10	19	1000	1120	SPT1AM561E10000RAXXX
		8x9	22	1000	1120	SPT1AM561F09000RAXXX
		8x11	18	1100	1360	SPT1AM681F11000RAXXX
		8x11	18	1200	1640	SPT1AM821F11000RAXXX
	1000	8x11	18	1200	2000	SPT1AM102F11000RAXXX
		10x12	15	1500	2000	SPT1AM102G12000RAXXX
		8x12	15	1300	2400	SPT1AM122F12000RAXXX
		10x12	15	1600	2400	SPT1AM122G12000RAXXX
	1500	10x12	15	1600	3000	SPT1AM152G12000RAXXX
		10x13	15	1700	3600	SPT1AM182G13000RAXXX
10x15		15	1800	4400	SPT1AM222G15000RAXXX	
10x18		15	1800	5000	SPT1AM332G18000RAXXX	
12 (13.8)	330	5.5x9	28	900	792	SPT1TM331B09000RAXXX
		5.5x9	28	900	1128	SPT1TM471B09000RAXXX
	470	6.3x9	28	1000	1128	SPT1TM471E09000RAXXX
		6.3x10	21	1000	1344	SPT1TM561E10000RAXXX
	680	6.3x11	21	1100	1632	SPT1TM681E11000RAXXX
		8x11	17	1100	1968	SPT1TM821F11000RAXXX
	1000	8x12	17	1200	2400	SPT1TM102F12000RAXXX
		8x14	17	1300	2880	SPT1TM122F14000RAXXX
1500	8x16	17	1400	3600	SPT1TM152F16000RAXXX	
	47	5x7	30	600	500	SPT1CM470D07000RAXXX
56		5x7	30	600	500	SPT1CM560D07000RAXXX
	68	5x7	30	600	500	SPT1CM680D07000RAXXX
82		5x8	30	600	500	SPT1CM820D08000RAXXX
	100	5x7	30	600	500	SPT1CM101D07000RAXXX
6.3x5		37	600	500	SPT1CM101E05000RAXXX	
6.3x8		30	800	500	SPT1CM101E08000RAXXX	
5x8		30	700	500	SPT1CM121D08000RAXXX	
120	5x8	30	700	500	SPT1CM151D08000RAXXX	
	5x8	30	700	500	SPT1CM181D08000RAXXX	
150	6.3x7	24	700	576	SPT1CM181E07000RAXXX	
	5x10	30	700	704	SPT1CM221D10000RAXXX	
	220	6.3x8	30	800	704	SPT1CM221E08000RAXXX
		6.3x10	22	800	704	SPT1CM221E10000RAXXX
180	5.5x9	30	800	864	SPT1CM271B09000RAXXX	
	6.3x8	30	800	864	SPT1CM271E08000RAXXX	
	8x9	30	800	864	SPT1CM271F09000RAXXX	
	5.5x9	30	800	1056	SPT1CM331B09000RAXXX	
330	6.3x9	30	800	1056	SPT1CM331E09000RAXXX	
	6.3x10	30	900	1056	SPT1CM331E10000RAXXX	
	6.3x11	22	900	1504	SPT1CM471E11000RAXXX	
	8x11	22	1300	1504	SPT1CM471F11000RAXXX	
470	8x9	19	1200	1504	SPT1CM471F09000RAXXX	
	8x11	22	900	1792	SPT1CM561F11000RAXXX	
	560	8x13	22	900	1792	SPT1CM561F13000RAXXX
		10x12	18	1000	1792	SPT1CM561G12000RAXXX
680	8x11	22	1000	2176	SPT1CM681F11000RAXXX	
	10x12	18	1000	2176	SPT1CM681G12000RAXXX	
	820	8x13	16	1000	2624	SPT1CM821F13000RAXXX
		10x12	18	1100	2624	SPT1CM821G12000RAXXX
1000	10x12	18	1200	3200	SPT1CM102G12000RAXXX	
	8x14	18	1200	3200	SPT1CM102F14000RAXXX	
	10x18	18	1600	4800	SPT1CM152G18000RAXXX	
	10x14	18	1600	5000	SPT1CM182G14000RAXXX	
2200	10x18	18	1700	5000	SPT1CM222G18000RAXXX	
	82	6.3x8	42	1290	500	SPT1DM820E08000RAXXX
120		6.3x8	42	700	500	SPT1DM121E08000RAXXX
	150	6.3x10	28	700	600	SPT1DM151E10000RAXXX
220		8x11	28	700	880	SPT1DM221F11000RAXXX
	270	8x11	28	800	1080	SPT1DM271F11000RAXXX
470		10x12	28	800	1880	SPT1DM471G12000RAXXX
	8x11	28	700	1880	SPT1DM471F11000RAXXX	
560	10x12	28	900	2240	SPT1DM561G12000RAXXX	
	10x15	28	900	2720	SPT1DM681G15000RAXXX	
	680	10x15	28	900	2720	SPT1DM681G15000RAXXX
		10x18	28	1000	3280	SPT1DM821G18000RAXXX
1000	10x18	28	1100	4000	SPT1DM102G18000RAXXX	
	25 (28.8)	22	5x9	90	500	500
33		5x9	90	500	500	SPT1EM330D09000RAXXX
39		5x8	90	500	500	SPT1EM390D08000RAXXX
47		5x9	90	500	500	SPT1EM470D09000RAXXX
56		5x9	90	600	500	SPT1EM560D09000RAXXX

Conductive Polymer Radial Type

PT series

■ STANDARD RATINGS

VDC (SV)	Cap (μF)	Size D×L(mm)	ESR (mΩ, 20°C, 100kHz) (max.)	Rated ripple current (mA rms/125°C, 100kHz)	Leakage Current (μA)(max.)	Part Number
25 (28.8)	68	6.3×7	45	600	500	SPT1EM680E07O00RAXXX
	82	6.3×7	45	600	500	SPT1EM820E07O00RAXXX
	100	6.3×8	45	700	500	SPT1EM101E08O00RAXXX
		6.3×10	30	800	500	SPT1EM101E10O00RAXXX
	120	8×11	30	900	500	SPT1EM101F11O00RAXXX
		6.3×8	45	700	600	SPT1EM121E08O00RAXXX
	150	6.3×10	30	800	750	SPT1EM151E10O00RAXXX
	180	6.3×10	30	800	900	SPT1EM181F10O00RAXXX
		8×9	45	700	1100	SPT1EM181F09O00RAXXX
	220	8×11	30	900	1100	SPT1EM221F11O00RAXXX
		10×12	30	1000	1350	SPT1EM221G12O00RAXXX
	270	8×11	30	900	1650	SPT1EM271F11O00RAXXX
		8×11	30	900	1650	SPT1EM331F11O00RAXXX
	330	10×12	30	1100	1650	SPT1EM331G12O00RAXXX
		10×10	37	800	2350	SPT1EM331G10O00RAXXX
	470	10×12	30	1200	2350	SPT1EM471G12O00RAXXX
		8×16	30	1000	2350	SPT1EM471F16O00RAXXX
	560	10×12	30	1200	2800	SPT1EM561G12O00RAXXX
680	10×15	30	1200	3400	SPT1EM681G15O00RAXXX	
	10×12	30	1200	3400	SPT1EM681G12O00RAXXX	
820	10×18	30	1200	4100	SPT1EM821G18O00RAXXX	
1000	10×18	30	1300	5000	SPT1EM102G18O00RAXXX	

Specifications subject to change without notice.

PK series

- Endurance: +135°C 1,000 hours
- High Temperature Resistance
- Recommended Applications: Large LED lamp power supply
- RoHS Compliant and lead-free



SPECIFICATIONS

Items	Characteristics							
Category Temperature Range	-55~+135°C							
Rated Working Voltage Range	6.3~25 V _{dc}							
Nominal Capacitance Range	100~1500μF							
Capacitance Tolerance	±20%(M) (at 20°C,120Hz)							
DC Leakage Current	I 0.2CV or 500μA, whichever is greater. Where, I:Max.leakage current (μA),C:Nominal capacitance (μF),V: Rated voltage (V) (at 20°C after 2 minutes)							
Dissipation Factor (tan δ)	Rated Voltage(V _{dc})	6.3	6.8	7.5	10	16	20	25
	tan δ (max.)	0.08			0.12			
ESR(100kHz,20°C)	Value in characteristics table							
Temperature Characteristic (Impedance Ratio at 100kHz)	Z(+135°C)/Z(+20°C) 1.25 Z(-55°C)/Z(+20°C) 1.25							
Endurance	After applying rated voltage for 1,000 hours at 135°C, the capacitors shall meet the following requirements.							
	Appearance	No significant damage						
	Capacitance Change	±20% of the initial value						
	D.F. (tan δ)	150% of the initial specified value						
	ESR	150% of the initial specified value						
Leakage Current	The initial specified value							
Humidity Test	After subjecting to 90~95% RH for 1,000 hours at 60°C without voltage applied,the capacitors shall meet the specified values for the Endurance characteristics listed above.							
Surge Test	After subjecting to 1,000 cycles each consisting of charge with the surge voltage specified at normal temperature for 30 seconds through a protective resistor and discharge for 5 minutes 30 seconds, the capacitors shall meet the following requirements.							
	Appearance	No significant damage						
	Capacitance Change	±20% of the initial value						
	D.F. (tan δ)	150% of the initial specified value						
	ESR	150% of the initial specified value						
Leakage Current	The initial specified value							

DIMENSIONS[mm]

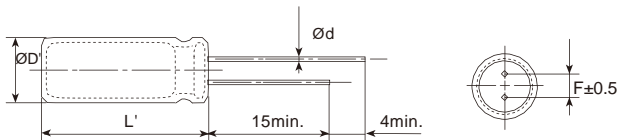

øD	5	5.5	6.3	8	10
ød	0.5	0.5	0.5	0.6	0.6
F	2.0	2.5	2.5	3.5	5.0
øD'	øD-0.1~+0.5				
L'	L+1.0max.			L-0.5~+1	

PART NUMBERING SYSTEM

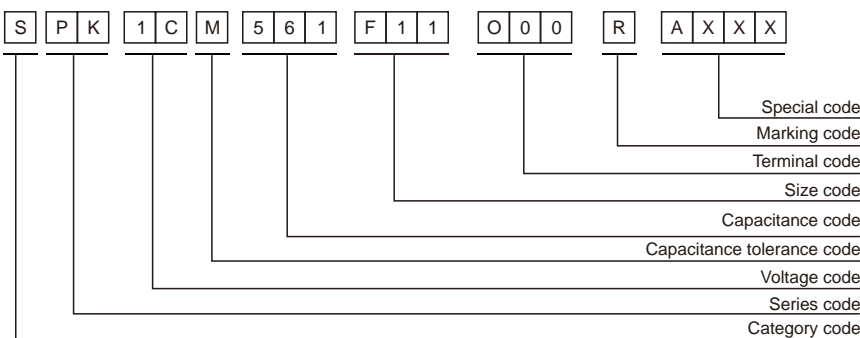

PK series

■ STANDARD RATINGS

VDC (SV)	Cap (μF)	Size DxL(mm)	ESR (mΩ, 20°C, 100kHz) (max.)	Rated ripple current (mA rms/135°C, 100kHz)	Leakage Current (μA)(max.)	Part Number
6.3 (7.2)	330	6.3x8	22	400	500	SPK0JM331E08O00RAXXX
	470	6.3x8	22	400	592	SPK0JM471E08O00RAXXX
	560	6.3x8	30	400	706	SPK0JM561E08O00RAXXX
	680	8x9	30	400	857	SPK0JM681F09O00RAXXX
	820	8x11	15	500	1033	SPK0JM821F11O00RAXXX
	1000	8x11	15	500	1260	SPK0JM102F11O00RAXXX
	1200	8x11	15	500	1512	SPK0JM122F11O00RAXXX
	1500	10x12	15	500	1890	SPK0JM152G12O00RAXXX
6.8 (7.8)	220	6.3x8	30	300	500	SPK0CM221E08O00RAXXX
	270	6.3x8	30	400	500	SPK0CM271E08O00RAXXX
	330	6.3x7	30	300	500	SPK0CM331E07O00RAXXX
	470	6.3x7	30	300	639	SPK0CM471E07O00RAXXX
	560	6.3x8	30	400	762	SPK0CM561E08O00RAXXX
	1000	8x11	20	500	1360	SPK0CM102F11O00RAXXX
7 (8.1)	470	6.3x7	30	300	658	SPK0QM471E07O00RAXXX
	560	6.3x8	30	400	784	SPK0QM561E08O00RAXXX
7.5 (8.6)	330	6.3x7	30	300	500	SPK0AM331E07O00RAXXX
	470	6.3x7	40	300	705	SPK0AM471E07O00RAXXX
	560	8x9	30	400	840	SPK0AM561F09O00RAXXX
	680	8x9	30	400	1020	SPK0AM681F09O00RAXXX
	1000	8x11	20	400	1500	SPK0AM102F11O00RAXXX
10 (11.5)	180	6.3x7	30	200	500	SPK1AM181E07O00RAXXX
	220	6.3x8	22	300	500	SPK1AM221E08O00RAXXX
	270	6.3x8	30	300	540	SPK1AM271E08O00RAXXX
	330	6.3x10	18	300	660	SPK1AM331E10O00RAXXX
	470	8x11	18	500	940	SPK1AM471F11O00RAXXX
	680	8x11	18	300	1360	SPK1AM681F11O00RAXXX
	1000	10x12	15	500	2000	SPK1AM102G12O00RAXXX
	1200	10x12	15	500	2400	SPK1AM122G12O00RAXXX
16 (18.4)	100	6.3x8	30	200	500	SPK1CM101E08O00RAXXX
	470	8x11	22	400	1504	SPK1CM471F11O00RAXXX
	560	10x12	18	300	1792	SPK1CM561G12O00RAXXX
	680	10x12	18	300	2176	SPK1CM681G12O00RAXXX
20 (23.0)	180	10x12	30	300	720	SPK1DM181G12O00RAXXX
	270	8x11	30	300	1080	SPK1DM271F11O00RAXXX
25(28.8)	270	8x11	30	300	1350	SPK1EM271F11O00RAXXX

Specifications subject to change without notice.

PF series

- Endurance: +105°C 3,000~5,000 hours
- Long life time
- Recommended Applications: System Board, Display Card, Small Charger and intelligent TV
- RoHS Compliant and lead-free

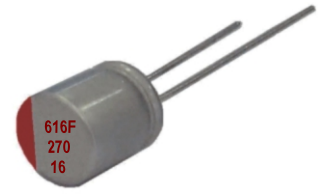

SPECIFICATIONS

Items	Characteristics									
Category Temperature Range	-55~+105°C									
Rated Working Voltage Range	6.3~100 V _{dc}									
Nominal Capacitance Range	4.7~5600μF									
Capacitance Tolerance	±20%(M) (at 20°C, 120Hz)									
DC Leakage Current	I 0.2CV or 500μA, whichever is greater. Where, I:Max.leakage current (μA), C:Nominal capacitance (μF), V: Rated voltage (V) (at 20°C after 2 minutes)									
DissipationFactor (tan)	Rated Voltage(V _{dc})	6.3	6.8	7.5	10	16	63	80	100	
	tan (max.)	0.08			0.12			0.15		(at 20°C, 120Hz)
ESR(100kHz,20°C)	Value in characteristics table									
Temperature Characteristic (Impedance Ratio at 100kHz)	Z(+105°C)/Z(+20°C) 1.25 Z(-55°C)/Z(+20°C) 1.25									
Endurance	After applying rated voltage for 3,000 to 5,000 hours at 105°C, the capacitors shall meet the following requirements.									
	Appearance	No significant damage								
	Capacitance Change	±20% of the initial value								
	D.F. (tan)	150% of the initial specified value								
	ESR	150% of the initial specified value								
	Leakage Current	The initial specified value								
Humidity Test	After subjecting to 90~95%RH for 2,000 hours at 60°C without voltage applied, the capacitors shall meet the specified values for the Endurance characteristics listed above.									
Surge Test	After subjecting to 1,000 cycles each consisting of charge with the surge voltage specified at normal temperature for 30 seconds through a protective resistor and discharge for 5 minutes 30 seconds, the capacitors shall meet the following requirements.									
	Appearance	No significant damage								
	Capacitance Change	±20% of the initial value								
	D.F. (tan)	150% of the initial specified value								
	ESR	150% of the initial specified value								
	Leakage Current	The initial specified value								

DIMENSIONS[mm]

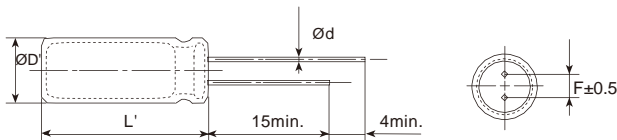

ØD	5	5.5	6.3	8	10
Ød	0.5	0.5	0.5	0.6	0.6
F	2.0	2.5	2.5	3.5	5.0
ØD'	ØD-0.1~+0.5				
L'	L+1.0max.			L-0.5~+1	

PART NUMBERING SYSTEM

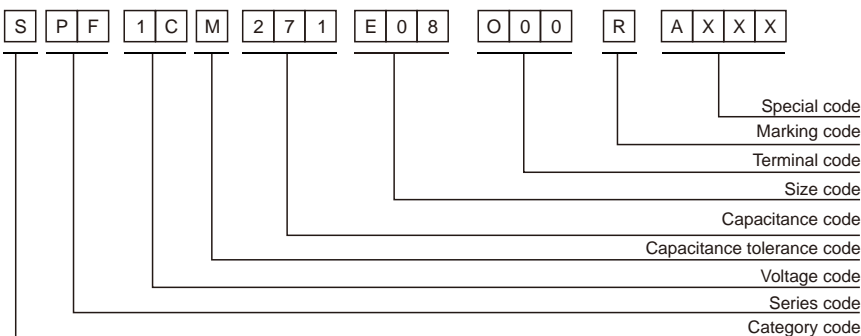

PF series

■ STANDARD RATINGS

VDC (SV)	Cap (μF)	Size DxL(mm)	ESR (mΩ, 20°C, 100kHz) (max.)	Rated ripple current (mA rms/105°C, 100kHz)	Leakage Current (μA)(max.)	Part Number
6.3 (7.2)	220	5x7	22	3100	500	SPF0JM221D07O00RAXXX
	270	5x7	22	3400	500	SPF0JM271D07O00RAXXX
	330	5x8	22	3600	500	SPF0JM331D08O00RAXXX
		6.3x5	27	2800	500	SPF0JM331E05O00RAXXX
	390	6.3x8	16	3600	500	SPF0JM331E08O00RAXXX
		5x9	22	3600	500	SPF0JM391D09O00RAXXX
	470	5x10	22	3800	592	SPF0JM471D10O00RAXXX
		5.5x9	22	3600	592	SPF0JM471B09O00RAXXX
		6.3x7	22	3500	592	SPF0JM471E07O00RAXXX
		6.3x8	16	3900	592	SPF0JM471E08O00RAXXX
	560	6.3x7	22	3700	706	SPF0JM561E07O00RAXXX
		6.3x8	22	4300	706	SPF0JM561E08O00RAXXX
		5.5x9	22	3800	706	SPF0JM561B09O00RAXXX
	680	6.3x9	22	4500	857	SPF0JM681E09O00RAXXX
		5.5x9	22	4300	857	SPF0JM681B09O00RAXXX
		8x9	22	4100	857	SPF0JM681F09O00RAXXX
	820	6.3x9	22	4500	1033	SPF0JM821E09O00RAXXX
		8x9	16	4200	1033	SPF0JM821F09O00RAXXX
		6.3x10	11	4600	1260	SPF0JM102E10O00RAXXX
	1000	8x9	13	4300	1260	SPF0JM102F09O00RAXXX
8x11		11	4600	1260	SPF0JM102F11O00RAXXX	
1200	8x11	11	4700	1512	SPF0JM122F11O00RAXXX	
1500	8x11	11	4800	1890	SPF0JM152F11O00RAXXX	
	10x12	11	4900	1890	SPF0JM152G12O00RAXXX	
1800	10x10	11	5000	2268	SPF0JM182G10O00RAXXX	
2200	8x14	11	5100	2772	SPF0JM222F14O00RAXXX	
	10x12	11	5200	2772	SPF0JM222G12O00RAXXX	
3300	10x14	11	5300	4158	SPF0JM332G14O00RAXXX	
4700	10x17	11	5400	5000	SPF0JM472G17O00RAXXX	
5600	10x18	11	5600	5000	SPF0JM562G18O00RAXXX	
6.8 (7.8)	220	5x7	22	2970	500	SPF0CM221D07O00RAXXX
	270	5x7	22	3240	500	SPF0CM271D07O00RAXXX
	330	5x8	22	3420	500	SPF0CM331D08O00RAXXX
	390	5x9	22	3510	530	SPF0CM391D09O00RAXXX
	470	5x9	22	3690	639	SPF0CM471D09O00RAXXX
		6.3x7	22	3330	639	SPF0CM471E07O00RAXXX
	560	6.3x8	22	4050	762	SPF0CM561E08O00RAXXX
	680	6.3x9	22	4320	925	SPF0CM681E09O00RAXXX
	820	6.3x9	22	4410	1115	SPF0CM821E09O00RAXXX
	1000	6.3x11	13	4590	1360	SPF0CM102E11O00RAXXX
	8x11	11	4635	1360	SPF0CM102F11O00RAXXX	
7 (8.1)	220	5x7	22	2880	500	SPF0QM221D07O00RAXXX
	270	5x8	22	3060	500	SPF0QM271D08O00RAXXX
	330	5x9	22	3240	500	SPF0QM331D09O00RAXXX
	470	6.3x8	22	3420	658	SPF0QM471E08O00RAXXX
		5.5x9	22	3240	658	SPF0QM471B09O00RAXXX
	560	6.3x8	22	3600	784	SPF0QM561E08O00RAXXX
	680	6.3x9	13	3780	952	SPF0QM681E09O00RAXXX
	820	6.3x10	13	4050	1148	SPF0QM821E10O00RAXXX
	8x9	13	4140	1148	SPF0QM821F09O00RAXXX	
7.5 (8.6)	220	5x7	22	2790	500	SPF0AM221D07O00RAXXX
	270	5x8	22	2970	500	SPF0AM271D08O00RAXXX
	330	5x9	22	3150	500	SPF0AM331D09O00RAXXX
	470	6.3x7	28	2880	705	SPF0AM471E07O00RAXXX
		5.5x9	22	3195	705	SPF0AM471B09O00RAXXX
	500	5.5x9	22	3240	750	SPF0AM501B09O00RAXXX
	560	6.3x8	22	3510	840	SPF0AM561E08O00RAXXX
	680	6.3x9	13	3690	1020	SPF0AM681E09O00RAXXX
	820	6.3x10	13	3960	1230	SPF0AM821E10O00RAXXX
		8x9	13	4095	1230	SPF0AM821F09O00RAXXX
1200	8x11	13	4320	1800	SPF0AM122F11O00RAXXX	
10 (11.5)	47	5x7	38	1900	500	SPF1AM470D07O00RAXXX
	56	5x7	38	2000	500	SPF1AM560D07O00RAXXX
	68	5x7	38	2000	500	SPF1AM680D07O00RAXXX
	82	5x7	38	2100	500	SPF1AM820D07O00RAXXX
	100	5x7	38	2100	500	SPF1AM101D07O00RAXXX
	120	5x7	22	2200	500	SPF1AM121D07O00RAXXX
	150	5x7	22	2200	500	SPF1AM151D07O00RAXXX
	220	5x9	22	2500	500	SPF1AM221D09O00RAXXX
		6.3x8	16	2800	500	SPF1AM221E08O00RAXXX
	270	6.3x8	22	2700	540	SPF1AM271E08O00RAXXX
	330	6.3x8	22	2900	660	SPF1AM331E08O00RAXXX
	390	8x9	16	3000	660	SPF1AM331F09O00RAXXX
		6.3x8	22	3000	780	SPF1AM391E08O00RAXXX

PF series

■ STANDARD RATINGS

VDC (SV)	Cap (μF)	Size DxL(mm)	ESR (mΩ, 20°C, 100kHz) (max.)	Rated ripple current (mArms/105°C, 100kHz)	Leakage Current (μA)(max.)	Part Number	
10 (11.5)	470	5.5x9	22	3000	940	SPF1AM471B09000RAXXX	
		6.3x8	22	3100	940	SPF1AM471E08000RAXXX	
		8x9	16	3100	940	SPF1AM471F09000RAXXX	
		8x11	13	5000	940	SPF1AM471F11000RAXXX	
	560	6.3x10	14	3200	1120	SPF1AM561E10000RAXXX	
		8x9	16	3200	1120	SPF1AM561F09000RAXXX	
		8x11	13	3500	1360	SPF1AM681F11000RAXXX	
	820	8x11	13	3600	1640	SPF1AM821F11000RAXXX	
		8x11	13	3700	2000	SPF1AM102F11000RAXXX	
	1000	10x12	11	4700	2000	SPF1AM102G12000RAXXX	
		8x12	11	4000	2400	SPF1AM122F12000RAXXX	
	1200	10x12	11	4900	2400	SPF1AM122G12000RAXXX	
		10x12	11	4900	3000	SPF1AM152G12000RAXXX	
	1800	10x13	11	5200	3600	SPF1AM182G13000RAXXX	
	2200	10x15	11	5400	4400	SPF1AM222G15000RAXXX	
3300	10x18	11	5500	5000	SPF1AM332G18000RAXXX		
12 (13.8)	330	5.5x9	22	2790	792	SPF1TM331B09000RAXXX	
		5.5x9	22	2880	1128	SPF1TM471B09000RAXXX	
	470	6.3x9	22	3105	1128	SPF1TM471E09000RAXXX	
		6.3x10	17	3060	1128	SPF1TM471E10000RAXXX	
	680	6.3x11	17	3240	1632	SPF1TM681E11000RAXXX	
		8x10	17	3330	1632	SPF1TM681F10000RAXXX	
	820	8x11	13	3420	1968	SPF1TM821F11000RAXXX	
	1000	8x12	13	3600	2400	SPF1TM102F12000RAXXX	
	1200	8x14	13	3960	2880	SPF1TM122F14000RAXXX	
	1500	8x16	13	4320	3600	SPF1TM152F16000RAXXX	
16 (18.4)	47	5x7	22	1800	500	SPF1CM470D07000RAXXX	
	56	5x7	22	1800	500	SPF1CM560D07000RAXXX	
	68	5x7	22	1900	500	SPF1CM680D07000RAXXX	
	82	5x8	22	1900	500	SPF1CM820D08000RAXXX	
	100	5x7	22	2000	500	SPF1CM101D07000RAXXX	
		6.3x5	27	1800	500	SPF1CM101E05000RAXXX	
	120	5x8	22	2100	500	SPF1CM121D08000RAXXX	
	150	5x8	22	2100	500	SPF1CM151D08000RAXXX	
		5x8	22	2200	576	SPF1CM181D08000RAXXX	
	180	6.3x7	17	2200	576	SPF1CM181E07000RAXXX	
		5x10	22	2300	704	SPF1CM221D10000RAXXX	
	220	6.3x8	22	2400	704	SPF1CM221E08000RAXXX	
		6.3x10	16	2600	704	SPF1CM221E10000RAXXX	
	270	5.5x9	22	2400	864	SPF1CM271B09000RAXXX	
		6.3x8	22	2500	864	SPF1CM271E08000RAXXX	
		8x9	22	2600	864	SPF1CM271F09000RAXXX	
	330	5.5x9	22	2600	1056	SPF1CM331B09000RAXXX	
		6.3x9	22	2600	1056	SPF1CM331E09000RAXXX	
		6.3x10	16	2700	1056	SPF1CM331E10000RAXXX	
	470	6.3x11	16	2800	1504	SPF1CM471E11000RAXXX	
		8x11	16	4100	1504	SPF1CM471F11000RAXXX	
	560	8x11	16	2800	1792	SPF1CM561F11000RAXXX	
		8x13	16	2800	1792	SPF1CM561F13000RAXXX	
	680	8x11	16	3000	2176	SPF1CM681F11000RAXXX	
		10x12	13	3200	2176	SPF1CM681G12000RAXXX	
	820	8x13	12	3100	2624	SPF1CM821F13000RAXXX	
		10x12	13	3400	2624	SPF1CM821G12000RAXXX	
	1000	10x12	13	3600	3200	SPF1CM102G12000RAXXX	
		8x14	13	3200	3200	SPF1CM102F14000RAXXX	
	1200	10x15	13	3800	3840	SPF1CM122G15000RAXXX	
		10x12	13	3700	3840	SPF1CM122G12000RAXXX	
	1500	10x18	13	4900	4800	SPF1CM152G18000RAXXX	
	1800	10x14	13	4800	5000	SPF1CM182G14000RAXXX	
	2200	10x17	13	5200	5000	SPF1CM222G17000RAXXX	
		10x15	13	4900	5000	SPF1CM222G15000RAXXX	
	20 (23.0)	33	5x8	44	1710	500	SPF1DM330D08000RAXXX
		39	5x8	44	1755	500	SPF1DM390D08000RAXXX
		47	5x8	44	1980	500	SPF1DM470D08000RAXXX
		56	5x9	44	1890	500	SPF1DM560D09000RAXXX
		68	6.3x8	33	1890	500	SPF1DM680E08000RAXXX
82		6.3x8	33	1935	500	SPF1DM820E08000RAXXX	
100		6.3x8	33	1980	500	SPF1DM101E08000RAXXX	
120		6.3x8	33	2070	500	SPF1DM121E08000RAXXX	
150		6.3x10	22	2115	600	SPF1DM151E10000RAXXX	
220		8x9	33	2205	880	SPF1DM221F09000RAXXX	
		8x11	22	2295	880	SPF1DM221F11000RAXXX	
270		8x11	22	2430	1080	SPF1DM271F11000RAXXX	
330		8x11	22	2520	1320	SPF1DM331F11000RAXXX	

Conductive Polymer
Radial Type

PF series

■ STANDARD RATINGS

VDC (SV)	Cap (μF)	Size DxL(mm)	ESR (mΩ, 20°C, 100kHz) (max.)	Rated ripple current (mArms/105°C, 100kHz)	Leakage Current (μA)(max.)	Part Number	
20 (23.0)	470	10x12	22	2610	1880	SPF1DM471G12O00RAXXX	
		10x13	22	2790	1880	SPF1DM471G13O00RAXXX	
	680	10x15	22	2970	2720	SPF1DM681G15O00RAXXX	
		10x12	22	2700	2720	SPF1DM681G12O00RAXXX	
	820	10x18	22	3060	3280	SPF1DM821G18O00RAXXX	
25 (28.8)	1000	10x18	22	3510	4000	SPF1DM102G18O00RAXXX	
	33	5x9	66	1600	500	SPF1EM330D09O00RAXXX	
		39	5x8	66	1700	500	SPF1EM390D08O00RAXXX
		47	5x9	66	1700	500	SPF1EM470D09O00RAXXX
		56	5x9	66	1800	500	SPF1EM560D09O00RAXXX
		82	6.3x7	33	1900	500	SPF1EM820E07O00RAXXX
	100	6.3x8	33	2200	500	SPF1EM101E08O00RAXXX	
		6.3x10	22	2500	500	SPF1EM101E10O00RAXXX	
		8x11	22	2700	500	SPF1EM101F11O00RAXXX	
		120	6.3x8	33	2200	600	SPF1EM121E08O00RAXXX
	150	6.3x10	22	2500	750	SPF1EM151E10O00RAXXX	
	180	8x9	33	2200	900	SPF1EM181F09O00RAXXX	
	220	8x11	22	2700	1100	SPF1EM221F11O00RAXXX	
	270	8x11	22	2700	1350	SPF1EM271F11O00RAXXX	
	330	8x11	22	2700	1650	SPF1EM331F11O00RAXXX	
		10x12	22	2500	1650	SPF1EM331G12O00RAXXX	
	470	10x12	22	3600	2350	SPF1EM471G12O00RAXXX	
		8x11	22	2700	2350	SPF1EM471F11O00RAXXX	
	680	10x15	22	3800	3400	SPF1EM681G15O00RAXXX	
	820	10x18	22	4000	4100	SPF1EM821G18O00RAXXX	
8x16		22	3200	4100	SPF1EM821F16O00RAXXX		
1000	10x18	22	4000	5000	SPF1EM102G18O00RAXXX		
35 (40.3)	4.7	5x8	66	1500	500	SPF1VM47D08O00RAXXX	
		5x8	66	1600	500	SPF1VM100D08O00RAXXX	
	15	5x8	66	1600	500	SPF1VM150D08O00RAXXX	
	22	5x9	110	1700	500	SPF1VM220D09O00RAXXX	
	33	5x9	55	1800	500	SPF1VM330D09O00RAXXX	
	39	5x9	55	1800	500	SPF1VM390D09O00RAXXX	
	47	6.3x7	55	1800	500	SPF1VM470E07O00RAXXX	
	56	6.3x7	55	1900	500	SPF1VM560E07O00RAXXX	
	68	6.3x7	55	1900	500	SPF1VM680E07O00RAXXX	
	82	6.3x7	55	2000	574	SPF1VM820E07O00RAXXX	
		6.3x8	55	2100	700	SPF1VM101E08O00RAXXX	
	100	6.3x10	44	2100	700	SPF1VM101E10O00RAXXX	
		8x11	44	2300	700	SPF1VM101F11O00RAXXX	
		120	6.3x10	44	2200	840	SPF1VM121E10O00RAXXX
		150	6.3x10	44	2200	1050	SPF1VM151E10O00RAXXX
	220	8x11	44	2500	1540	SPF1VM221F11O00RAXXX	
	270	10x12	33	2600	1540	SPF1VM221G12O00RAXXX	
	330	10x12	33	2700	1890	SPF1VM271G12O00RAXXX	
	470	10x12	33	2700	2310	SPF1VM331G12O00RAXXX	
	470	10x13	22	2800	3290	SPF1VM471G13O00RAXXX	
680	10x16	22	3000	4760	SPF1VM681G16O00RAXXX		
820	10x18	22	3100	5000	SPF1VM821G18O00RAXXX		
	10x18	22	3300	5000	SPF1VM102G18O00RAXXX		
50 (57.5)	4.7	5x8	66	1300	500	SPF1HM47D08O00RAXXX	
		6.3x7	38	1600	500	SPF1HM100E07O00RAXXX	
	10	5x8	77	1400	500	SPF1HM100D08O00RAXXX	
	15	5x8	77	1400	500	SPF1HM150D08O00RAXXX	
	22	6.3x7	44	1700	500	SPF1HM220E07O00RAXXX	
	33	6.3x7	44	1800	500	SPF1HM330E07O00RAXXX	
	47	6.3x8	38	1800	500	SPF1HM470E08O00RAXXX	
	56	6.3x8	38	1900	560	SPF1HM560E08O00RAXXX	
	68	6.3x10	33	1900	680	SPF1HM680E10O00RAXXX	
	100	8x11	33	2000	1000	SPF1HM101F11O00RAXXX	
	120	8x11	33	2100	1200	SPF1HM121F11O00RAXXX	
	150	10x12	33	2200	1500	SPF1HM151G12O00RAXXX	
	220	10x12	33	2400	2200	SPF1HM221G12O00RAXXX	
	270	10x13	22	2600	2700	SPF1HM271G13O00RAXXX	
	330	10x15	22	2700	3300	SPF1HM331G15O00RAXXX	
	440	10x18	22	2700	4400	SPF1HM441G18O00RAXXX	
	470	10x18	22	2800	4700	SPF1HM471G18O00RAXXX	
		6.3x8	66	1400	500	SPF1JM47E08O00RAXXX	
	63 (72.5)	6.8	6.3x8	66	1400	500	SPF1JM68E08O00RAXXX
		10	6.3x5	66	1400	500	SPF1JM100E05O00RAXXX
33		6.3x8	33	1500	500	SPF1JM330E08O00RAXXX	
39		6.3x8	33	1500	500	SPF1JM390E08O00RAXXX	

PF series

■ STANDARD RATINGS

VDC (SV)	Cap (μF)	Size DxL(mm)	ESR (mΩ, 20°C, 100kHz) (max.)	Rated ripple current (mA _{rms} /105°C, 100kHz)	Leakage Current (μA)(max.)	Part Number
63 (72.5)	47	6.3x9	33	1700	592	SPF1JM470E09O00RAXXX
	56	8x9	33	1600	706	SPF1JM560F09O00RAXXX
	68	8x11	33	1800	857	SPF1JM680F11O00RAXXX
	82	8x11	33	1800	1033	SPF1JM820F11O00RAXXX
	100	10x12	33	1900	1260	SPF1JM101G12O00RAXXX
	150	10x12	33	2200	1890	SPF1JM151G12O00RAXXX
	220	10x15	22	2300	2772	SPF1JM221G15O00RAXXX
	270	10x17	22	2500	3402	SPF1JM271G17O00RAXXX
80 (92.0)	330	10x18	22	2600	4158	SPF1JM331G18O00RAXXX
	4.7	6.3x8	66	1300	500	SPF1BM4R7E08O00RAXXX
	6.8	6.3x8	66	1300	500	SPF1BM6R8E08O00RAXXX
	22	6.3x10	66	1400	500	SPF1BM220E10O00RAXXX
	33	8x11	38	1500	528	SPF1BM330F11O00RAXXX
	47	10x12	38	1600	752	SPF1BM470G12O00RAXXX
	68	10x12	38	1700	1088	SPF1BM680G12O00RAXXX
	100	10x14	38	1800	1600	SPF1BM101G14O00RAXXX
100 (115.0)	4.7	6.3x8	132	1200	500	SPF1KM4R7E08O00RAXXX
	6.8	6.3x8	132	1300	500	SPF1KM6R8E08O00RAXXX
	10	6.3x10	55	1300	500	SPF1KM100E10O00RAXXX
		8x11	55	1300	500	SPF1KM100F11O00RAXXX
	15	8x11	55	1300	500	SPF1KM150F11O00RAXXX
	22	10x12	38	1400	500	SPF1KM220G12O00RAXXX
	33	10x14	38	1400	660	SPF1KM330G14O00RAXXX
	47	10x16	38	1600	940	SPF1KM470G16O00RAXXX

Conductive Polymer Radial Type

Specifications subject to change without notice.

PU series

- Endurance: +105°C 2,000 hours
- Ultra-Low ESR
- Recommended Applications: High Order Main Board, Display Card
- RoHS Compliant and lead-free



SPECIFICATIONS

Items	Characteristics							
Category Temperature Range	-55~+105°C							
Rated Working Voltage Range	6.3~25 V _{dc}							
Nominal Capacitance Range	39~5600μF							
Capacitance Tolerance	±20%(M) (at 20°C,120Hz)							
DC Leakage Current	I ≤ 0.2CV or 500μA, whichever is greater. Where, I:Max.leakage current (μA),C:Nominal capacitance (μF),V: Rated voltage (V) (at 20°C after 2 minutes)							
Dissipation Factor (tan δ)	Rated Voltage(V _{dc})	6.3	6.8	7.5	10	16	20	25
	tan δ (max.)	0.08			0.12			
ESR(100kHz,20°C)	Value in characteristics table							
Temperature Characteristic (Impedance Ratio at 100kHz)	Z(+105°C)/Z(+20°C) 1.25 Z(-55°C)/Z(+20°C) 1.25							
Endurance	After applying rated voltage for 2,000 hours at 105°C, the capacitors shall meet the following requirements.							
	Appearance	No significant damage						
	Capacitance Change	±20% of the initial value						
	D.F. (tan δ)	150% of the initial specified value						
	ESR	150% of the initial specified value						
Leakage Current	The initial specified value							
Humidity Test	After subjected to 90~95% RH for 2,000 hours at 60°C without voltage applied,the capacitors shall meet the specified values for the Endurance characteristics listed above.							
Surge Test	After subjected to 1,000 cycles each consisting of charge with the surge voltage specified at normal temperature for 30 seconds through a protective resistor and discharge for 5 minutes 30 seconds, the capacitors shall meet the following requirements.							
	Appearance	No significant damage						
	Capacitance Change	±20% of the initial value						
	D.F. (tan δ)	150% of the initial specified value						
	ESR	150% of the initial specified value						
Leakage Current	The initial specified value							

DIMENSIONS[mm]

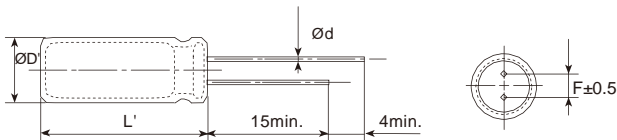

ØD	5	5.5	6.3	8	10
Ød	0.5	0.5	0.5	0.6	0.6
F	2.0	2.5	2.5	3.5	5.0
ØD'	ØD-0.1~+0.5				
L'	L+1.0max.			L-0.5~+1	

PART NUMBERING SYSTEM

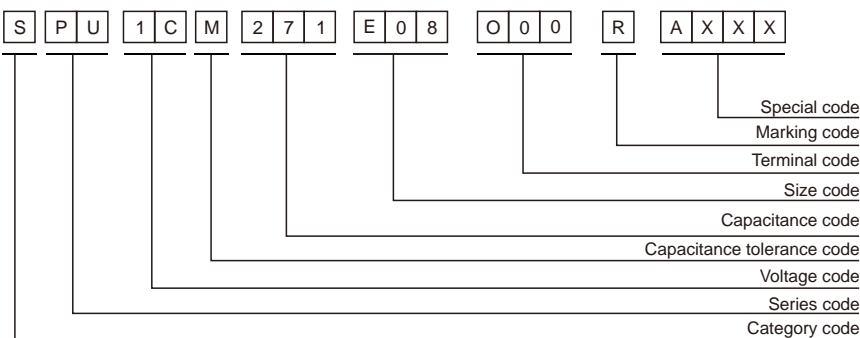

PU series

■ STANDARD RATINGS

VDC (SV)	Cap (μF)	Size DxL(mm)	ESR (mΩ, 20°C, 100kHz) (max.)	Rated ripple current (mA rms/105°C, 100kHz)	Leakage Current (μA)(max.)	Part Number
6.3 (7.2)	220	5x7	14	3800	500	SPU0JM221D07000RAXXX
	270	5x7	14	4100	500	SPU0JM271D07000RAXXX
	330	5x8	14	4400	500	SPU0JM331D08000RAXXX
		6.3x5	17	3400	500	SPU0JM331E05000RAXXX
	390	6.3x8	10	4400	500	SPU0JM331E08000RAXXX
		5x9	14	4500	500	SPU0JM391D09000RAXXX
	470	5x10	14	4700	592	SPU0JM471D10000RAXXX
		5.5x9	14	4500	592	SPU0JM471B09000RAXXX
		6.3x7	14	4200	592	SPU0JM471E07000RAXXX
		6.3x8	10	4800	592	SPU0JM471E08000RAXXX
	560	6.3x7	14	4600	706	SPU0JM561E07000RAXXX
		6.3x8	8	5200	706	SPU0JM561E08000RAXXX
		5.5x9	14	4700	706	SPU0JM561B09000RAXXX
	680	6.3x9	14	5500	857	SPU0JM681E09000RAXXX
		5.5x9	14	5200	857	SPU0JM681B09000RAXXX
	820	8x9	14	5000	857	SPU0JM681F09000RAXXX
		6.3x9	14	5500	1033	SPU0JM821E09000RAXXX
	1000	8x9	10	5100	1033	SPU0JM821F09000RAXXX
		6.3x10	8	5600	1260	SPU0JM102E10000RAXXX
		8x9	8	5200	1260	SPU0JM102F09000RAXXX
8x11		8	5700	1260	SPU0JM102F11000RAXXX	
1200	8x11	8	5800	1512	SPU0JM122F11000RAXXX	
1500	8x11	8	5900	1890	SPU0JM152F11000RAXXX	
1800	10x12	8	6000	1890	SPU0JM152G12000RAXXX	
2200	10x10	8	6100	2268	SPU0JM182G10000RAXXX	
	8x14	8	6200	2772	SPU0JM222F14000RAXXX	
	10x12	8	6300	2772	SPU0JM222G12000RAXXX	
	10x14	8	6400	4158	SPU0JM332G14000RAXXX	
4700	10x17	8	6700	5000	SPU0JM472G17000RAXXX	
5600	10x18	8	6900	5000	SPU0JM562G18000RAXXX	
6.8 (7.8)	220	5x7	15	3630	500	SPU0CM221D07000RAXXX
	270	5x7	15	3960	500	SPU0CM271D07000RAXXX
	330	5x8	15	4180	500	SPU0CM331D08000RAXXX
		6.3x5	20	3410	500	SPU0CM331E05000RAXXX
	390	5x9	15	4290	530	SPU0CM391D09000RAXXX
	470	5x9	15	4510	639	SPU0CM471D09000RAXXX
		6.3x7	15	4070	639	SPU0CM471E07000RAXXX
	560	6.3x8	15	4950	762	SPU0CM561E08000RAXXX
	680	6.3x9	15	5280	925	SPU0CM681E09000RAXXX
	820	6.3x9	15	5390	1115	SPU0CM821E09000RAXXX
1000	6.3x11	10	5610	1360	SPU0CM102E11000RAXXX	
	8x11	8	5665	1360	SPU0CM102F11000RAXXX	
7 (8.1)	220	5x7	18	3520	500	SPU0QM221D07000RAXXX
	270	5x8	18	3740	500	SPU0QM271D08000RAXXX
	330	5x9	18	3960	500	SPU0QM331D09000RAXXX
	470	6.3x8	18	4180	658	SPU0QM471E08000RAXXX
		5.5x9	18	3960	658	SPU0QM471B09000RAXXX
	560	6.3x8	18	4400	784	SPU0QM561E08000RAXXX
	680	6.3x9	11	4620	952	SPU0QM681E09000RAXXX
	820	6.3x10	11	4950	1148	SPU0QM821E10000RAXXX
	8x9	11	5060	1148	SPU0QM821F09000RAXXX	
7.5 (8.6)	220	5x7	18	3410	500	SPU0AM221D07000RAXXX
	270	5x8	18	3630	500	SPU0AM271D08000RAXXX
	330	5x9	18	3850	500	SPU0AM331D09000RAXXX
	390	5x9	18	3850	585	SPU0AM391D09000RAXXX
		6.3x7	23	3520	705	SPU0AM471E07000RAXXX
	470	5.5x9	18	3905	705	SPU0AM471B09000RAXXX
		5.5x9	18	3960	750	SPU0AM501B09000RAXXX
	560	6.3x8	18	4290	840	SPU0AM561E08000RAXXX
	680	6.3x9	11	4510	1020	SPU0AM681E09000RAXXX
	820	6.3x10	11	4840	1230	SPU0AM821E10000RAXXX
		8x9	11	5005	1230	SPU0AM821F09000RAXXX
	1200	8x11	11	5280	1800	SPU0AM122F11000RAXXX
10 (11.5)	47	5x7	24	2400	500	SPU1AM470D07000RAXXX
	56	5x7	24	2400	500	SPU1AM560D07000RAXXX
	68	5x7	24	2500	500	SPU1AM680D07000RAXXX
	82	5x7	24	2500	500	SPU1AM820D07000RAXXX
	100	5x7	24	2600	500	SPU1AM101D07000RAXXX
	120	5x7	14	2600	500	SPU1AM121D07000RAXXX
	150	5x7	14	2700	500	SPU1AM151D07000RAXXX
	220	5x9	14	3100	500	SPU1AM221D09000RAXXX
	6.3x8	10	3400	500	SPU1AM221E08000RAXXX	

Conductive Polymer Radial Type

PU series

■ STANDARD RATINGS

VDC (SV)	Cap (μF)	Size DxL(mm)	ESR (mΩ, 20°C, 100kHz)(max.)	Rated ripple current (mA rms/105°C, 100kHz)	Leakage Current (μA)(max.)	Part Number
10 (11.5)	270	6.3x8	14	3400	540	SPU1AM271E08O00RAXXX
	330	6.3x8	14	3600	660	SPU1AM331E08O00RAXXX
		8x9	10	3700	660	SPU1AM331F09O00RAXXX
	390	6.3x10	8	3800	660	SPU1AM331E10O00RAXXX
		6.3x8	14	3700	780	SPU1AM391E08O00RAXXX
	470	5.5x9	14	3700	940	SPU1AM471B09O00RAXXX
		6.3x8	14	3800	940	SPU1AM471E08O00RAXXX
		8x9	10	3900	940	SPU1AM471F09O00RAXXX
		8x11	8	6200	940	SPU1AM471F11O00RAXXX
		6.3x10	9	3900	1120	SPU1AM561E10O00RAXXX
		8x9	10	3900	1120	SPU1AM561F09O00RAXXX
	680	8x11	8	4200	1360	SPU1AM681F11O00RAXXX
	820	8x11	8	4400	1640	SPU1AM821F11O00RAXXX
	1000	8x11	8	4600	2000	SPU1AM102F11O00RAXXX
		10x12	8	5800	2000	SPU1AM102G12O00RAXXX
	1200	8x12	8	4900	2400	SPU1AM122F12O00RAXXX
		10x12	8	5900	2400	SPU1AM122G12O00RAXXX
	1500	10x12	8	6000	3000	SPU1AM152G12O00RAXXX
1800	10x13	8	6300	3600	SPU1AM182G13O00RAXXX	
2200	10x15	8	6700	4400	SPU1AM222G15O00RAXXX	
3300	10x18	8	6800	5000	SPU1AM332G18O00RAXXX	
12 (13.8)	330	5.5x9	18	3410	792	SPU1TM331B09O00RAXXX
	470	5.5x9	18	3520	1128	SPU1TM471B09O00RAXXX
		6.3x9	18	3795	1128	SPU1TM471E09O00RAXXX
	560	6.3x10	14	3740	1344	SPU1TM561E10O00RAXXX
	680	6.3x11	14	3960	1632	SPU1TM681E11O00RAXXX
		8x10	14	4070	1632	SPU1TM681F11O00RAXXX
	820	8x11	11	4180	1968	SPU1TM821F11O00RAXXX
	1000	8x12	11	4400	2400	SPU1TM102F12O00RAXXX
1200	8x14	11	4840	2880	SPU1TM122F14O00RAXXX	
	8x16	11	5280	3600	SPU1TM152F16O00RAXXX	
16 (18.4)	47	5x7	14	2200	500	SPU1CM470D07O00RAXXX
	56	5x7	14	2300	500	SPU1CM560D07O00RAXXX
	68	5x7	14	2300	500	SPU1CM680D07O00RAXXX
	82	5x8	14	2400	500	SPU1CM820D08O00RAXXX
	100	5x7	14	2400	500	SPU1CM101D07O00RAXXX
		6.3x5	17	2300	500	SPU1CM101E05O00RAXXX
	120	6.3x8	14	3000	500	SPU1CM101E08O00RAXXX
		5x8	14	2500	500	SPU1CM121D08O00RAXXX
	150	5x8	14	2600	500	SPU1CM151D08O00RAXXX
	180	5x8	14	2600	576	SPU1CM181D08O00RAXXX
		6.3x7	11	2700	576	SPU1CM181E07O00RAXXX
	220	5x10	14	2800	704	SPU1CM221D10O00RAXXX
		6.3x8	14	2900	704	SPU1CM221E08O00RAXXX
	270	6.3x10	10	3100	704	SPU1CM221E10O00RAXXX
		5.5x9	14	3000	864	SPU1CM271B09O00RAXXX
		6.3x8	14	3000	864	SPU1CM271E08O00RAXXX
		8x9	14	3100	864	SPU1CM271F09O00RAXXX
		5.5x9	14	3100	1056	SPU1CM331B09O00RAXXX
		6.3x9	14	3100	1056	SPU1CM331E09O00RAXXX
	330	6.3x10	10	3400	1056	SPU1CM331E10O00RAXXX
		6.3x11	10	3500	1504	SPU1CM471E11O00RAXXX
	470	8x11	10	5000	1504	SPU1CM471F11O00RAXXX
		8x11	10	3500	1792	SPU1CM561F11O00RAXXX
	560	8x13	10	3600	1792	SPU1CM561F13O00RAXXX
		10x12	8	3800	1792	SPU1CM561G12O00RAXXX
	680	8x11	10	3700	2176	SPU1CM681F11O00RAXXX
		10x12	8	3900	2176	SPU1CM681G12O00RAXXX
	820	8x13	8	3800	2624	SPU1CM821F13O00RAXXX
		10x12	8	4100	2624	SPU1CM821G12O00RAXXX
	1000	10x12	8	4400	3200	SPU1CM102G12O00RAXXX
		8x14	8	3900	3200	SPU1CM102F14O00RAXXX
	1200	10x15	8	4700	3840	SPU1CM122G15O00RAXXX
1500	10x18	8	6000	4800	SPU1CM152G18O00RAXXX	
1800	10x15	9	5900	5000	SPU1CM182G15O00RAXXX	
2200	10x18	8	6300	5000	SPU1CM222G18O00RAXXX	
20 (23.0)	39	5x8	36	2145	500	SPU1DM390D08O00RAXXX
	47	5x8	36	2420	500	SPU1DM470D08O00RAXXX
	56	5x9	36	2310	500	SPU1DM560D09O00RAXXX
	68	6.3x8	27	2310	500	SPU1DM680E08O00RAXXX
	82	6.3x8	27	2365	500	SPU1DM820E08O00RAXXX

PU series

■ STANDARD RATINGS

VDC (SV)	Cap (μF)	Size DxL(mm)	ESR (mΩ, 20°C, 100kHz) (max.)	Rated ripple current (mA rms/105°C, 100kHz)	Leakage Current (μA)(max.)	Part Number
20 (23.0)	100	6.3x8	27	2420	500	SPU1DM101E08O00RAXXX
	120	6.3x8	27	2530	500	SPU1DM121E08O00RAXXX
	150	6.3x10	18	2585	600	SPU1DM151E10O00RAXXX
	180	8x9	27	2695	720	SPU1DM181F09O00RAXXX
	220	8x11	15	4100	880	SPU1DM221F11O00RAXXX
	270	8x11	15	3500	1080	SPU1DM271F11O00RAXXX
	330	8x11	15	3600	1320	SPU1DM331F11O00RAXXX
	470	10x12	15	3700	1880	SPU1DM471G12O00RAXXX
	560	10x13	15	3800	2240	SPU1DM561G13O00RAXXX
	680	10x15	15	3900	2720	SPU1DM681G15O00RAXXX
	820	10x18	15	4000	3280	SPU1DM821G18O00RAXXX
	1000	10x18	15	4300	4000	SPU1DM102G18O00RAXXX
25 (28.8)	39	5x8	42	2000	500	SPU1EM390D08O00RAXXX
	47	5x9	42	2100	500	SPU1EM470D09O00RAXXX
	56	5x9	42	2200	500	SPU1EM560D09O00RAXXX
	68	6.3x7	21	2300	500	SPU1EM680E07O00RAXXX
	82	6.3x7	21	2300	500	SPU1EM820E07O00RAXXX
	100	6.3x8	21	2700	500	SPU1EM101E08O00RAXXX
		6.3x10	14	3000	500	SPU1EM101E10O00RAXXX
	120	8x11	14	3300	500	SPU1EM101F11O00RAXXX
		6.3x8	21	2700	600	SPU1EM121E08O00RAXXX
	150	6.3x10	14	3000	750	SPU1EM151E10O00RAXXX
	180	8x9	21	2700	900	SPU1EM181F09O00RAXXX
	220	8x11	14	3300	1100	SPU1EM221F11O00RAXXX
		10x12	14	3800	1100	SPU1EM221G12O00RAXXX
	270	8x11	14	3300	1350	SPU1EM271F11O00RAXXX
		8x11	14	3400	1650	SPU1EM331F11O00RAXXX
	330	10x12	14	4100	1650	SPU1EM331G12O00RAXXX
		10x12	14	4400	2350	SPU1EM471G12O00RAXXX
	470	8x16	14	3700	2350	SPU1EM471F16O00RAXXX
		10x12	14	4400	2800	SPU1EM561G12O00RAXXX
	560	10x12	14	4400	2800	SPU1EM561G12O00RAXXX
	680	10x15	14	4700	3400	SPU1EM681G15O00RAXXX
	820	10x18	14	4900	4100	SPU1EM821G18O00RAXXX
	1000	10x18	14	4900	5000	SPU1EM102G18O00RAXXX

Conductive Polymer Radial Type

Specifications subject to change without notice.

PR series

- Endurance: +105°C 5,000 hours
- Low ESR, ripple current resistant
- Recommended Applications: Adaptor
- **RoHS Compliant and lead-free**

New



SPECIFICATIONS

Items	Characteristics						
Category Temperature Range	-55~+105°C						
Rated Working Voltage Range	2.5~35 V _{dc}						
Nominal Capacitance Range	47~1500μF						
Capacitance Tolerance	±20%(M) (at 20°C, 120Hz)						
DC Leakage Current	LC=0.2CV or 500μA, whichever is greater. Where, I:Max.leakage current (μA),C:Nominal capacitance (μF),V: Rated voltage (V) (at 20°C after 2 minutes)						
Dissipation Factor (tan δ)	Rated Voltage(V _{dc})	2.5	6.3	10	16	25	35
	tan δ (max.)	0.08		0.12			
ESR(100kHz,20°C)	Value in characteristics table						
Temperature Characteristic (Impedance Ratio at 100kHz)	Z(+105°C)/Z(+20°C) 1.25 Z(-55°C)/Z(+20°C) 1.25						
Endurance	After applying rated voltage with rated ripple current for 5,000 hours at 105°C,the capacitors shall meet the following requirements.						
	Appearance	No significant damage					
	Capacitance Change	±20% of the initial value					
	D.F. (tan δ)	150% of the initial specified value					
	ESR	150% of the initial specified value					
	Leakage Current	The initial specified value					
Humidity Test	After subjecting to 90%~95% RH for 2,000 hours at 60°C without voltage applied, the capacitors shall meet the requirement as in surge test.						
Surge Test	After subjecting to 1,000 cycles each consisting of charge with the surge voltage specified at normal temperature for 30 seconds through a protective resistor and discharge for 5 minutes 30 seconds, the capacitors shall meet the following requirements.						
	Appearance	No significant damage					
	Capacitance Change	±20% of the initial value					
	D.F. (tan δ)	150% of the initial specified value					
	ESR	150% of the initial specified value					
	Leakage Current	The initial specified value					

DIMENSIONS[mm]

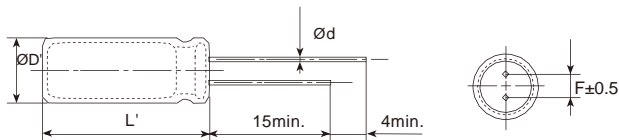

ØD	5	5.5	6.3	8	10
Ød	0.5	0.5	0.5	0.6	0.6
F	2.0	2.5	2.5	3.5	5.0
ØD'	ØD-0.1~+0.5	ØD±0.3	ØD-0.1~+0.5		
L'	L+1.0max.			L-0.5~+1	

PART NUMBERING SYSTEM

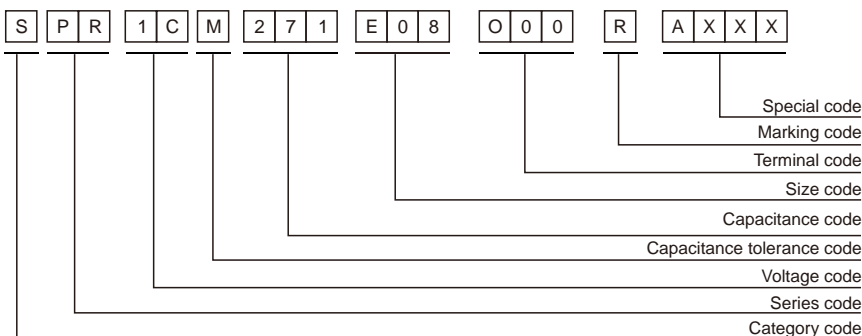

PR series

■ STANDARD RATINGS

VDC (SV)	Cap (μF)	Size DxL(mm)	ESR (mΩ, 20°C, 100kHz) (max.)	Rated ripple current (mA rms/105°C, 100kHz)	Leakage Current (μA)(max.)	Part Number
2.5 (2.9)	560	6.3x8	12	2000	500	SPR0EM561E08000RAXXX
	680	6.3x8	12	2000	500	SPR0EM681E08000RAXXX
	820	6.3x9	12	2000	500	SPR0EM821E09000RAXXX
	1200	8x9	14	2100	600	SPR0EM122F09000RAXXX
6.3 (7.2)	330	6.3x8	12	1900	500	SPR0JM331E08000RAXXX
	470	6.3x8	12	1900	592	SPR0JM471E08000RAXXX
		8x9	14	2100	592	SPR0JM471F09000RAXXX
	560	6.3x8	12	1900	706	SPR0JM561E08000RAXXX
	680	8x11	12	2200	857	SPR0JM681F11000RAXXX
	820	8x11	12	2200	1033	SPR0JM821F11000RAXXX
	1000	8x11	12	2300	1260	SPR0JM102F11000RAXXX
	1200	8x11	12	2300	1512	SPR0JM122F11000RAXXX
1500	10x12	12	2500	1890	SPR0JM152G12000RAXXX	
10 (11.5)	220	6.3x8	12	1700	500	SPR1AM221E08000RAXXX
	270	6.3x8	12	1700	540	SPR1AM271E08000RAXXX
	330	6.3x10	12	1800	660	SPR1AM331E10000RAXXX
	470	8x11	12	2000	940	SPR1AM471F11000RAXXX
	560	8x11	12	2000	1120	SPR1AM561F11000RAXXX
	680	8x11	12	2100	1360	SPR1AM681F11000RAXXX
	820	8x11	12	2100	1640	SPR1AM821F11000RAXXX
	1000	10x12	12	2200	2000	SPR1AM102G12000RAXXX
	1200	10x12	12	2200	2400	SPR1AM122G12000RAXXX
1500	10x12	12	2400	3000	SPR1AM152G12000RAXXX	
16 (18.4)	100	6.3x8	17	1500	500	SPR1CM101E08000RAXXX
	180	6.3x8	17	1500	576	SPR1CM181E08000RAXXX
	220	6.3x10	17	1600	704	SPR1CM221E10000RAXXX
	270	8x11	14	1700	864	SPR1CM271F11000RAXXX
	330	6.3x10	14	1600	1056	SPR1CM331E10000RAXXX
	470	8x11	14	1700	1504	SPR1CM471F11000RAXXX
	560	10x12	14	2000	1792	SPR1CM561G12000RAXXX
	680	10x12	14	2000	2176	SPR1CM681G12000RAXXX
	820	10x12	14	2100	2624	SPR1CM821G12000RAXXX
1000	10x12	14	2100	3200	SPR1CM102G12000RAXXX	
25 (28.8)	68	6.3x7	24	1300	500	SPR1EM680E07000RAXXX
	82	6.3x7	24	1300	500	SPR1EM820E07000RAXXX
		6.3x8	24	1300	500	SPR1EM101E08000RAXXX
	100	8x11	22	1500	500	SPR1EM101F11000RAXXX
	120	6.3x10	22	1400	600	SPR1EM121E10000RAXXX
	180	8x9	24	1300	900	SPR1EM181F09000RAXXX
	220	8x11	22	1500	1100	SPR1EM221F11000RAXXX
		10x12	22	1700	1100	SPR1EM221G12000RAXXX
	270	8x11	22	1500	1350	SPR1EM271F11000RAXXX
	330	10x12	22	1700	1650	SPR1EM331G12000RAXXX
	470	8x16	22	1700	2350	SPR1EM471F16000RAXXX
		10x12	22	1800	2350	SPR1EM471G12000RAXXX
560	10x12	22	1800	2800	SPR1EM561G12000RAXXX	
35 (40.3)	47	6.3x7	52	1100	500	SPR1VM470E07000RAXXX
	56	6.3x7	52	1100	500	SPR1VM560E07000RAXXX
	68	6.3x7	52	1100	500	SPR1VM680E07000RAXXX
	82	6.3x7	52	1100	574	SPR1VM820E07000RAXXX
	100	6.3x10	42	1200	700	SPR1VM101E10000RAXXX
	150	10x12	32	1400	1050	SPR1VM151G12000RAXXX
		8x11	32	1300	1540	SPR1VM221F11000RAXXX
	220	10x12	32	1400	1540	SPR1VM221G12000RAXXX
	270	10x12	32	1400	1890	SPR1VM271G12000RAXXX
	330	10x12	32	1400	2310	SPR1VM331G12000RAXXX

Conductive Polymer Radial Type

RZ series

- Endurance: +105°C 2,000 hours
- Low ESR, ripple current resistant
- Recommended Applications: Adaptor
- **RoHS Compliant and lead-free**

New



SPECIFICATIONS

Items	Characteristics						
Category Temperature Range	-55~+105°C						
Rated Working Voltage Range	2.5~35 V _{dc}						
Nominal Capacitance Range	47~1500μF						
Capacitance Tolerance	±20%(M) (at 20°C, 120Hz)						
DC Leakage Current	LC=0.2CV or 500μA, whichever is greater. Where, I:Max.leakage current (μA), C:Nominal capacitance (μF), V: Rated voltage (V) (at 20°C after 2 minutes)						
Dissipation Factor (tan δ)	Rated Voltage(V _{dc})	2.5	6.3	10	16	25	35
	tan δ (max.)	0.08		0.12			
ESR(100kHz, 20°C)	Value in characteristics table						
Temperature Characteristic (Impedance Ratio at 100kHz)	Z(+105°C)/Z(+20°C) 1.25 Z(-55°C)/Z(+20°C) 1.25						
Endurance	After applying rated voltage with rated ripple current for 2,000 hours at 105°C, the capacitors shall meet the following requirements.						
	Appearance	No significant damage					
	Capacitance Change	±20% of the initial value					
	D.F. (tan δ)	150% of the initial specified value					
	ESR	150% of the initial specified value					
Leakage Current	The initial specified value						
Humidity Test	After subjecting to 90%~95% RH for 2,000 hours at 60°C without voltage applied, the capacitors shall meet the requirement as in surge test.						
Surge Test	After subjecting to 1,000 cycles each consisting of charge with the surge voltage specified at normal temperature for 30 seconds through a protective resistor and discharge for 5 minutes 30 seconds, the capacitors shall meet the following requirements.						
	Appearance	No significant damage					
	Capacitance Change	±20% of the initial value					
	D.F. (tan δ)	150% of the initial specified value					
	ESR	150% of the initial specified value					
Leakage Current	The initial specified value						

DIMENSIONS[mm]

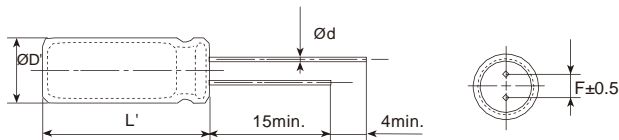

ØD	5	5.5	6.3	8	10
Ød	0.5	0.5	0.5	0.6	0.6
F	2.0	2.5	2.5	3.5	5.0
ØD'	ØD-0.1~+0.5	ØD±0.3	ØD-0.1~+0.5		
L'	L+1.0max.			L-0.5~+1	

PART NUMBERING SYSTEM

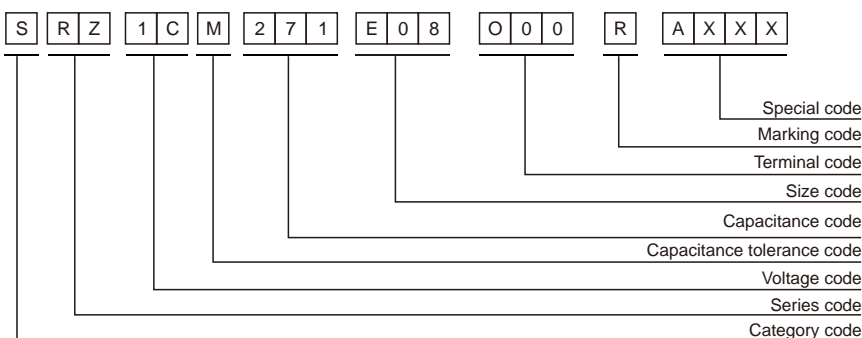

RZ series

■ STANDARD RATINGS

VDC (SV)	Cap (μF)	Size DxL(mm)	ESR (mΩ, 20°C, 100kHz) (max.)	Rated ripple current (mA rms/105°C, 100kHz)	Leakage Current (μA)(max.)	Part Number
2.5 (2.9)	560	6.3x8	10	3000	500	SRZ0EM561E08O00RAXXX
	680	6.3x8	10	3000	500	SRZ0EM681E08O00RAXXX
	820	6.3x9	10	3000	500	SRZ0EM821E09O00RAXXX
	1200	8x9	12	3200	600	SRZ0EM122F09O00RAXXX
6.3 (7.2)	330	6.3x8	10	2800	500	SRZ0JM331E08O00RAXXX
	470	6.3x8	10	2800	592	SRZ0JM471E08O00RAXXX
		8x9	12	3200	592	SRZ0JM471F09O00RAXXX
	560	6.3x8	10	2800	706	SRZ0JM561E08O00RAXXX
	680	8x11	10	3400	857	SRZ0JM681F11O00RAXXX
	820	8x11	10	3400	1033	SRZ0JM821F11O00RAXXX
	1000	8x11	10	3600	1260	SRZ0JM102F11O00RAXXX
	1200	8x11	10	3600	1512	SRZ0JM122F11O00RAXXX
1500	10x12	10	4000	1890	SRZ0JM152G12O00RAXXX	
10 (11.5)	220	6.3x8	10	2400	500	SRZ1AM221E08O00RAXXX
	270	6.3x8	10	2400	540	SRZ1AM271E08O00RAXXX
	330	6.3x10	10	2600	660	SRZ1AM331E10O00RAXXX
	470	8x11	10	3000	940	SRZ1AM471F11O00RAXXX
	560	8x11	10	3000	1120	SRZ1AM561F11O00RAXXX
	680	8x11	10	3200	1360	SRZ1AM681F11O00RAXXX
	820	8x11	10	3200	1640	SRZ1AM821F11O00RAXXX
	1000	10x12	10	3400	2000	SRZ1AM102G12O00RAXXX
	1200	10x12	10	3400	2400	SRZ1AM122G12O00RAXXX
	1500	10x12	10	3800	3000	SRZ1AM152G12O00RAXXX
16 (18.4)	100	6.3x8	15	2000	500	SRZ1CM101E08O00RAXXX
	180	6.3x8	15	2000	576	SRZ1CM181E08O00RAXXX
	220	6.3x10	15	2200	704	SRZ1CM221E10O00RAXXX
	270	8x11	12	2400	864	SRZ1CM271F11O00RAXXX
	330	6.3x10	12	2200	1056	SRZ1CM331E10O00RAXXX
	470	8x11	12	2400	1504	SRZ1CM471F11O00RAXXX
	560	10x12	12	3000	1792	SRZ1CM561G12O00RAXXX
	680	10x12	12	3000	2176	SRZ1CM681G12O00RAXXX
	820	10x12	12	3200	2624	SRZ1CM821G12O00RAXXX
	1000	10x12	12	3200	3200	SRZ1CM102G12O00RAXXX
25 (28.8)	68	6.3x7	22	1600	500	SRZ1EM680E07O00RAXXX
	82	6.3x7	22	1600	500	SRZ1EM820E07O00RAXXX
		6.3x8	22	1600	500	SRZ1EM101E08O00RAXXX
	100	8x11	20	2000	500	SRZ1EM101F11O00RAXXX
	120	6.3x10	20	1800	600	SRZ1EM121E10O00RAXXX
	180	8x9	22	1600	900	SRZ1EM181F09O00RAXXX
	220	8x11	20	2000	1100	SRZ1EM221F11O00RAXXX
		10x12	20	2400	1100	SRZ1EM221G12O00RAXXX
	270	8x11	20	2000	1350	SRZ1EM271F11O00RAXXX
	330	10x12	20	2400	1650	SRZ1EM331G12O00RAXXX
	470	8x16	20	2400	2350	SRZ1EM471F16O00RAXXX
	560	10x12	20	2600	2350	SRZ1EM471G12O00RAXXX
	10x12	20	2600	2800	SRZ1EM561G12O00RAXXX	
35 (40.3)	47	6.3x7	50	1200	500	SRZ1VM470E07O00RAXXX
	56	6.3x7	50	1200	500	SRZ1VM560E07O00RAXXX
	68	6.3x7	50	1200	500	SRZ1VM680E07O00RAXXX
	82	6.3x7	50	1200	574	SRZ1VM820E07O00RAXXX
	100	6.3x10	40	1400	700	SRZ1VM101E10O00RAXXX
	150	10x12	30	1800	1050	SRZ1VM151G12O00RAXXX
		8x11	30	1600	1540	SRZ1VM221F11O00RAXXX
	220	10x12	30	1800	1540	SRZ1VM221G12O00RAXXX
	270	10x12	30	1800	1890	SRZ1VM271G12O00RAXXX
	330	10x12	30	1800	2310	SRZ1VM331G12O00RAXXX

Conductive Polymer Radial Type

RT series

- Endurance: +125°C 2,000 hours
- Low ESR, ripple current resistant
- Recommended Applications: Adaptor
- **RoHS Compliant and lead-free**

New

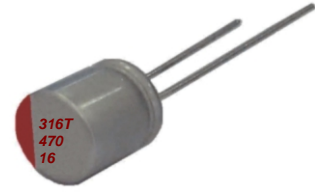

SPECIFICATIONS

Items	Characteristics						
Category Temperature Range	-55~+125°C						
Rated Working Voltage Range	2.5~35 V _{dc}						
Nominal Capacitance Range	47~1500μF						
Capacitance Tolerance	±20%(M) (at 20°C, 120Hz)						
DC Leakage Current	LC=0.2CV or 500μA, whichever is greater. Where, I:Max.leakage current (μA),C:Nominal capacitance (μF),V: Rated voltage (V) (at 20°C after 2 minutes)						
Dissipation Factor (tan δ)	Rated Voltage(V _{dc})	2.5	6.3	10	16	25	35
	tan δ (max.)	0.08		0.12			
ESR(100kHz, 20°C)	Value in characteristics table						
Temperature Characteristic (Impedance Ratio at 100kHz)	Z(+125°C)/Z(+20°C) 1.25 Z(-55°C)/Z(+20°C) 1.25						
Endurance	After applying rated voltage with rated ripple current for 2,000 hours at 125°C, the capacitors shall meet the following requirements.						
	Appearance	No significant damage					
	Capacitance Change	±20% of the initial value					
	D.F. (tan δ)	150% of the initial specified value					
	ESR	150% of the initial specified value					
Leakage Current	The initial specified value						
Humidity Test	After subjecting to 90%~95% RH for 2,000 hours at 60°C without voltage applied, the capacitors shall meet the requirement as in surge test.						
Surge Test	After subjecting to 1,000 cycles each consisting of charge with the surge voltage specified at normal temperature for 30 seconds through a protective resistor and discharge for 5 minutes 30 seconds, the capacitors shall meet the following requirements.						
	Appearance	No significant damage					
	Capacitance Change	±20% of the initial value					
	D.F. (tan δ)	150% of the initial specified value					
	ESR	150% of the initial specified value					
Leakage Current	The initial specified value						

DIMENSIONS[mm]

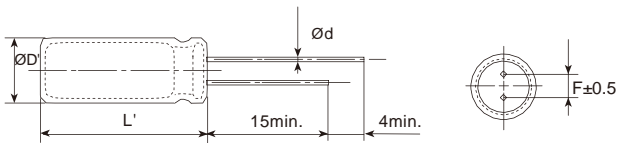

ØD	5	5.5	6.3	8	10
Ød	0.5	0.5	0.5	0.6	0.6
F	2.0	2.5	2.5	3.5	5.0
ØD'	ØD-0.1~+0.5		ØD±0.3		
L'	L+1.0max.			L-0.5~+1	

PART NUMBERING SYSTEM

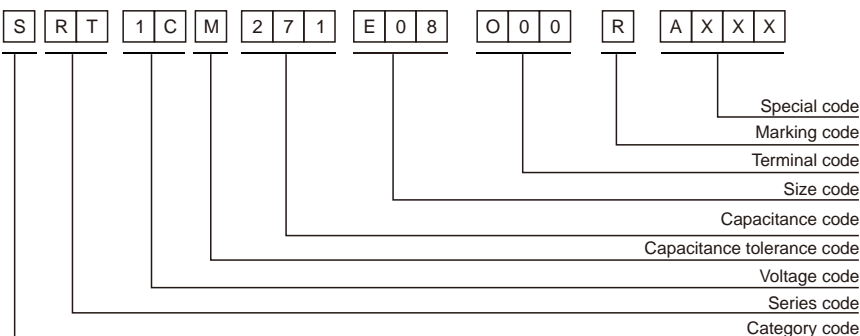

RT series

■ STANDARD RATINGS

VDC (SV)	Cap (μF)	Size DxL(mm)	ESR (mΩ, 20°C, 100kHz) (max.)	Rated ripple current (mA rms/125°C, 100kHz)	Leakage Current (μA)(max.)	Part Number
2.5 (2.9)	560	6.3x8	15	1200	500	SRT0EM561E08O00RAXXX
	680	6.3x8	15	1200	500	SRT0EM681E08O00RAXXX
	820	6.3x9	15	1200	500	SRT0EM821E09O00RAXXX
	1200	8x9	17	1300	600	SRT0EM122F09O00RAXXX
6.3 (7.2)	330	6.3x8	15	1100	500	SRT0JM331E08O00RAXXX
	470	6.3x8	15	1100	592	SRT0JM471E08O00RAXXX
		8x9	17	1300	592	SRT0JM471F09O00RAXXX
	560	6.3x8	15	1100	706	SRT0JM561E08O00RAXXX
	680	8x11	15	1400	857	SRT0JM681F11O00RAXXX
	820	8x11	15	1400	1033	SRT0JM821F11O00RAXXX
	1000	8x11	15	1500	1260	SRT0JM102F11O00RAXXX
	1200	8x11	15	1500	1512	SRT0JM122F11O00RAXXX
1500	10x12	15	1700	1890	SRT0JM152G12O00RAXXX	
10 (11.5)	220	6.3x8	15	900	500	SRT1AM221E08O00RAXXX
	270	6.3x8	15	900	540	SRT1AM271E08O00RAXXX
	330	6.3x10	15	1000	660	SRT1AM331E10O00RAXXX
	470	8x11	15	1200	940	SRT1AM471F11O00RAXXX
	560	8x11	15	1200	1120	SRT1AM561F11O00RAXXX
	680	8x11	15	1300	1360	SRT1AM681F11O00RAXXX
	820	8x11	15	1300	1640	SRT1AM821F11O00RAXXX
	1000	10x12	15	1400	2000	SRT1AM102G12O00RAXXX
	1200	10x12	15	1400	2400	SRT1AM122G12O00RAXXX
	1500	10x12	15	1600	3000	SRT1AM152G12O00RAXXX
16 (18.4)	100	6.3x8	20	800	500	SRT1CM101E08O00RAXXX
	180	6.3x8	20	800	576	SRT1CM181E08O00RAXXX
	220	6.3x10	20	890	704	SRT1CM221E10O00RAXXX
	270	8x11	17	900	864	SRT1CM271F11O00RAXXX
	330	6.3x10	17	800	1056	SRT1CM331E10O00RAXXX
	470	8x11	17	900	1504	SRT1CM471F11O00RAXXX
	560	10x12	17	1200	1792	SRT1CM561G12O00RAXXX
	680	10x12	17	1200	2176	SRT1CM681G12O00RAXXX
	820	10x12	17	1300	2624	SRT1CM821G12O00RAXXX
	1000	10x12	17	1300	3200	SRT1CM102G12O00RAXXX
25 (28.8)	68	6.3x7	27	600	500	SRT1EM680E07O00RAXXX
	82	6.3x7	27	600	500	SRT1EM820E07O00RAXXX
	100	6.3x8	27	600	500	SRT1EM101E08O00RAXXX
		8x11	25	800	500	SRT1EM101F11O00RAXXX
	120	6.3x10	25	700	600	SRT1EM121E10O00RAXXX
	180	8x9	27	600	900	SRT1EM181F09O00RAXXX
	220	8x11	25	800	1100	SRT1EM221F11O00RAXXX
		10x12	25	900	1100	SRT1EM221G12O00RAXXX
	270	8x11	25	800	1350	SRT1EM271F11O00RAXXX
	330	10x12	25	900	1650	SRT1EM331G12O00RAXXX
	470	8x16	25	900	2350	SRT1EM471F16O00RAXXX
	560	10x12	25	1000	2350	SRT1EM471G12O00RAXXX
	10x12	25	1000	2800	SRT1EM561G12O00RAXXX	
35 (40.3)	47	6.3x7	55	400	500	SRT1VM470E07O00RAXXX
	56	6.3x7	55	400	500	SRT1VM560E07O00RAXXX
	68	6.3x7	55	400	500	SRT1VM680E07O00RAXXX
	82	6.3x7	55	400	574	SRT1VM820E07O00RAXXX
	100	6.3x10	45	500	700	SRT1VM101E10O00RAXXX
	150	10x12	35	700	1050	SRT1VM151G12O00RAXXX
	220	8x11	35	600	1540	SRT1VM221F11O00RAXXX
		10x12	35	700	1540	SRT1VM221G12O00RAXXX
	270	10x12	35	700	1890	SRT1VM271G12O00RAXXX
	330	10x12	35	700	2310	SRT1VM331G12O00RAXXX

Conductive Polymer Radial Type

VZ series

- Endurance: +105°C 2,000 hours
- Standard substance
- Recommended Applications: Display Card & System Board
- **RoHS Compliant and lead-free**



SPECIFICATIONS

Items	Characteristics								
Category Temperature Range	-55~+105°C								
Rated Working Voltage Range	2.5~100 V _{dc}								
Nominal Capacitance Range	22~2200μF								
Capacitance Tolerance	±20%(M) (at 20°C,120Hz)								
DC Leakage Current	I 0.2CV or 500μA, whichever is greater. Where, I:Max.leakage current (μA),C:Nominal capacitance (μF),V: Rated voltage (V) (at 20°C after 2 minutes)								
Dissipation Factor (tan δ)	Rated Voltage(V _{dc})	2.5	6.3	10	16	25	35	50	63
	tan δ (max.)	0.08			0.12 (at 20°C,120Hz)				
ESR(100kHz,20°C)	Value in characteristics table								
Temperature Characteristic (Impedance Ratio at 100kHz)	Z(+105°C)/Z(+20°C) 1.25 Z(-55°C)/Z(+20°C) 1.25								
Endurance	After applying rated voltage for 2,000 hours at 105°C, the capacitors shall meet the following requirements.								
	Appearance	No significant damage							
	Capacitance Change	±20% of the initial value							
	D.F. (tan δ)	150% of the initial specified value							
	ESR	150% of the initial specified value							
Leakage Current	The initial specified value								
Humidity Test	After subjecting to 90~95% RH for 2,000 hours at 60°C without voltage applied, the capacitors shall meet the specified values for the Endurance characteristics listed above.								
Surge Test	After subjecting to 1,000 cycles each consisting of charge with the surge voltage specified at normal temperature for 30 seconds through a protective resistor and discharge for 5 minutes 30 seconds, the capacitors shall meet the following requirements.								
	Appearance	No significant damage							
	Capacitance Change	±20% of the initial value							
	D.F. (tan δ)	150% of the initial specified value							
	ESR	150% of the initial specified value							
Leakage Current	The initial specified value								

*Note: If any doubt arises, measure the leakage current after the following voltage treatment.
Voltage treatment: DC rated voltage is applied to the capacitors for 120 minutes at 105°C.

DIMENSIONS[mm]

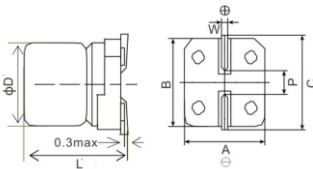

D	6.3	8	10
P±0.2	1.9	3.1	4.5
A±0.2	6.6	8.3	10.3
B±0.2	6.6	8.3	10.3
C±0.2	7.2	9.0	11.0
W	0.5~0.8	0.7~1.1	0.7~1.1
ØD'	ØD-0.1~+0.5	ØD-0.1~+0.5	ØD-0.1~+0.5
L'	L±0.5	L±0.3	L±0.3

PART NUMBERING SYSTEM

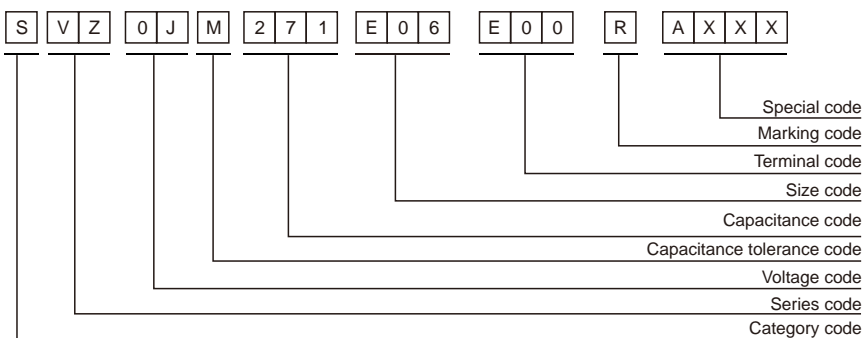

VZ series

■ STANDARD RATINGS

VDC (SV)	Cap (μF)	Size DxL(mm)	ESR (mΩ, 20°C, 100kHz) (max.)	Rated ripple current (mArms/105°C, 100kHz)	Leakage Current (μA)(max.)	Part Number
2.5 (2.9)	330	6.3x6	20	2700	500	SVZ0EM331E06E00RAXXX
	390	6.3x6	20	2800	500	SVZ0EM391E06E00RAXXX
	470	6.3x6	20	2900	500	SVZ0EM471E06E00RAXXX
	560	6.3x6	20	3000	500	SVZ0EM561E06E00RAXXX
	680	6.3x9	15	4300	500	SVZ0EM681E09E00RAXXX
6.3 (7.2)	220	6.3x6	20	2800	500	SVZ0JM221E06E00RAXXX
	270	6.3x6	20	3000	500	SVZ0JM271E06E00RAXXX
	330	6.3x6	20	2100	500	SVZ0JM331E06E00RAXXX
	470	6.3x9	15	3500	592	SVZ0JM471E09E00RAXXX
	560	6.3x9	15	3700	706	SVZ0JM561E09E00RAXXX
	1000	8x11.5	15	4300	1260	SVZ0JM102FBRE00RAXXX
	1500	8x11.5	15	4400	1890	SVZ0JM152FBRE00RAXXX
10 (11.5)	2200	10x12.5	15	5600	2772	SVZ0JM222GCRE00RAXXX
	120	6.3x6	30	2700	500	SVZ1AM121E06E00RAXXX
	220	6.3x6	30	2700	500	SVZ1AM221E06E00RAXXX
	330	6.3x9	20	3000	500	SVZ1AM221E09E00RAXXX
	330	6.3x9	20	3100	660	SVZ1AM331E09E00RAXXX
	470	6.3x9	30	3400	940	SVZ1AM471E09E00RAXXX
	560	8x9.5	22	3400	940	SVZ1AM471F9RE00RAXXX
	560	8x11.5	20	3600	1120	SVZ1AM561FBRE00RAXXX
	1000	10x12.5	20	5000	1120	SVZ1AM561GCRE00RAXXX
	1000	8x11.5	15	4200	2000	SVZ1AM102FBRE00RAXXX
16 (18.4)	1500	10x12.5	15	4400	2000	SVZ1AM102GCRE00RAXXX
	1500	10x12.5	15	4400	3000	SVZ1AM152GCRE00RAXXX
	47	6.3x6	40	1700	500	SVZ1CM470E06E00RAXXX
	68	6.3x6	40	2000	500	SVZ1CM680E06E00RAXXX
	100	6.3x6	30	2400	500	SVZ1CM101E06E00RAXXX
	150	6.3x6	30	2400	500	SVZ1CM151E06E00RAXXX
	150	6.3x9	25	2600	500	SVZ1CM151E09E00RAXXX
	180	6.3x6	60	2500	576	SVZ1CM181E06E00RAXXX
	180	6.3x9	25	2700	576	SVZ1CM181F09E00RAXXX
	220	6.3x9	25	2500	704	SVZ1CM221E09E00RAXXX
	270	6.3x9	25	2600	864	SVZ1CM271E09E00RAXXX
	270	8x9.5	25	2800	864	SVZ1CM271F9RE00RAXXX
	330	6.3x9	25	2600	1056	SVZ1CM331E09E00RAXXX
	330	8x11.5	20	4000	1056	SVZ1CM331FBRE00RAXXX
	560	10x12.5	20	5000	1056	SVZ1CM331GCRE00RAXXX
25 (28.8)	680	8x11.5	20	3500	1792	SVZ1CM561FBRE00RAXXX
	1000	10x12.5	20	4000	2176	SVZ1CM681GCRE00RAXXX
	1000	10x12.5	20	4100	3200	SVZ1CM102GCRE00RAXXX
	22	6.3x6	80	1600	500	SVZ1EM220E06E00RAXXX
	27	6.3x6	50	1100	500	SVZ1EM270E06E00RAXXX
	47	6.3x6	50	1800	500	SVZ1EM470E06E00RAXXX
	47	6.3x9	35	2000	500	SVZ1EM470E09E00RAXXX
	56	6.3x6	50	1800	500	SVZ1EM560E06E00RAXXX
	68	6.3x6	50	1800	500	SVZ1EM680E06E00RAXXX
	100	6.3x9	30	2400	500	SVZ1EM101E09E00RAXXX
	150	6.3x6	50	2100	500	SVZ1EM101E06E00RAXXX
	150	6.3x9	30	2500	750	SVZ1EM151E09E00RAXXX
	220	6.3x9	30	2500	1100	SVZ1EM221E09E00RAXXX
	330	8x11.5	30	2600	1100	SVZ1EM221FBRE00RAXXX
	330	10x12.5	22	2800	1650	SVZ1EM331GCRE00RAXXX
	470	8x11.5	30	2700	500	SVZ1EM331FBRE00RAXXX
	470	8x11.5	30	2800	2350	SVZ1EM471FBRE00RAXXX
	560	10x12.5	22	3100	2350	SVZ1EM471GCRE00RAXXX
680	10x12.5	22	3300	2800	SVZ1EM561GCRE00RAXXX	
35 (40.3)	680	10x12.5	22	3300	3400	SVZ1EM681GCRE00RAXXX
	22	6.3x6	60	1100	500	SVZ1VM220E06E00RAXXX
	27	6.3x6	60	1100	500	SVZ1VM270E06E00RAXXX
	33	6.3x6	60	1100	500	SVZ1VM330E06E00RAXXX
	47	6.3x9	50	1500	500	SVZ1VM470E09E00RAXXX
	68	6.3x6	45	1100	500	SVZ1VM470E06E00RAXXX
	68	6.3x6	45	1100	500	SVZ1VM680E06E00RAXXX
	68	6.3x9	40	1800	500	SVZ1VM680E09E00RAXXX
	100	6.3x9	40	2100	700	SVZ1VM101E09E00RAXXX
	150	8x9.5	40	2800	700	SVZ1VM101F9RE00RAXXX
	220	8x11.5	30	3000	700	SVZ1VM101FBRE00RAXXX
	270	8x11.5	30	3000	700	SVZ1VM101FBRE00RAXXX
	330	8x11.5	30	3000	1050	SVZ1VM151FBRE00RAXXX
	470	10x12.5	30	2400	1540	SVZ1VM221FBRE00RAXXX
	470	10x12.5	30	2500	1890	SVZ1VM271FBRE00RAXXX
	470	10x12.5	30	2700	1890	SVZ1VM271GCRE00RAXXX
	470	10x12.5	30	2700	2310	SVZ1VM331GCRE00RAXXX
	470	10x12.5	30	3000	3290	SVZ1VM471GCRE00RAXXX
50 (57.5)	22	6.3x6	80	800	500	SVZ1HM220E06E00RAXXX
	33	6.3x6	80	850	500	SVZ1HM330E06E00RAXXX
	47	6.3x9	60	1400	500	SVZ1HM470E09E00RAXXX
	68	8x11.5	30	2000	680	SVZ1HM680FBRE00RAXXX
	82	10x12.5	30	2000	820	SVZ1HM820GCRE00RAXXX
	100	8x11.5	30	2000	820	SVZ1HM820FBRE00RAXXX
	100	8x11.5	30	2000	1000	SVZ1HM101FBRE00RAXXX
	120	10x12.5	30	2100	1000	SVZ1HM101GCRE00RAXXX
	150	8x11.5	30	2000	1200	SVZ1HM121FBRE00RAXXX
	150	10x12.5	30	2100	1500	SVZ1HM151GCRE00RAXXX
	220	10x12.5	30	2300	2200	SVZ1HM221GCRE00RAXXX

Conductive Polymer SMD Type

VZ series

■ STANDARD RATINGS

VDC (SV)	Cap (μF)	Size DxL(mm)	ESR (mΩ, 20°C, 100kHz) (max.)	Rated ripple current (mA rms/105°C, 100kHz)	Leakage Current (μA)(max.)	Part Number
63 (72.5)	22	6.3x6	80	450	500	SVZ1JM220E06E00RAXXX
	33	6.3x9	60	500	500	SVZ1JM330E09E00RAXXX
	47	8x9.5	60	1000	592	SVZ1JM470F9RE00RAXXX
	56	8x11.5	40	1400	706	SVZ1JM560FBRE00RAXXX
	100	10x12.5	40	1600	1260	SVZ1JM101GCRE00RAXXX
80 (92.0)	27	8x11.5	50	600	500	SVZ1BM270FBRE00RAXXX
	47	10x12.5	50	900	752	SVZ1BM470GCRE00RAXXX
	68	10x12.5	50	900	1088	SVZ1BM680GCRE00RAXXX
100 (115.0)	22	8x11.5	50	600	500	SVZ1KM220FBRE00RAXXX
	47	10x12.5	50	900	940	SVZ1KM470GCRE00RAXXX

Specifications subject to change without notice.

VS series

- Endurance: +105°C 2,000 hours
- Low ESR
- Recommended Applications: High order main board, server
- RoHS Compliant and lead-free



SPECIFICATIONS

Items	Characteristics						
Category Temperature Range	-55~+105°C						
Rated Working Voltage Range	2.5~25 V _{dc}						
Nominal Capacitance Range	27~2200μF						
Capacitance Tolerance	±20%(M) (at 20°C, 120Hz)						
DC Leakage Current	I ≤ 0.2CV or 500μA, whichever is greater. Where, I: Max. leakage current (μA), C: Nominal capacitance (μF), V: Rated voltage (V) (at 20°C after 2 minutes)						
Dissipation Factor (tan δ)	Rated Voltage (V _{dc})	2.5	6.3	10	16	25	(at 20°C, 120Hz)
	tan δ (max.)	0.08			0.12		
ESR(100kHz,20°C)	Value in characteristics table						
Temperature Characteristic (Impedance Ratio at 100kHz)	Z(+105°C)/Z(+20°C) 1.25 Z(-55°C)/Z(+20°C) 1.25						
Endurance	After applying rated voltage for 2,000 hours at 105°C, the capacitors shall meet the following requirements.						
	Appearance	No significant damage					
	Capacitance Change	±20% of the initial value					
	D.F. (tan δ)	150% of the initial specified value					
	ESR	150% of the initial specified value					
Leakage Current	The initial specified value						
Humidity Test	After subjecting to 90~95% RH for 2,000 hours at 60°C without voltage applied, the capacitors shall meet the specified values for the Endurance characteristics listed above.						
Surge Test	After subjecting to 1,000 cycles each consisting of charge with the surge voltage specified at normal temperature for 30 seconds through a protective resistor and discharge for 5 minutes 30 seconds, the capacitors shall meet the following requirements.						
	Appearance	No significant damage					
	Capacitance Change	±20% of the initial value					
	D.F. (tan δ)	150% of the initial specified value					
	ESR	150% of the initial specified value					
Leakage Current	The initial specified value						

*Note: If any doubt arises, measure the leakage current after the following voltage treatment.
Voltage treatment: DC rated voltage is applied to the capacitors for 120 minutes at 105°C.

DIMENSIONS[mm]

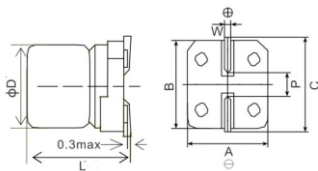

D	6.3	8	10
P±0.2	1.9	3.1	4.5
A±0.2	6.6	8.3	10.3
B±0.2	6.6	8.3	10.3
C±0.2	7.2	9.0	11.0
W	0.5~0.8	0.7~1.1	0.7~1.1
ØD'	ØD-0.1~+0.5	ØD-0.1~+0.5	ØD-0.1~+0.5
L'	L±0.5	L±0.3	L±0.3

PART NUMBERING SYSTEM

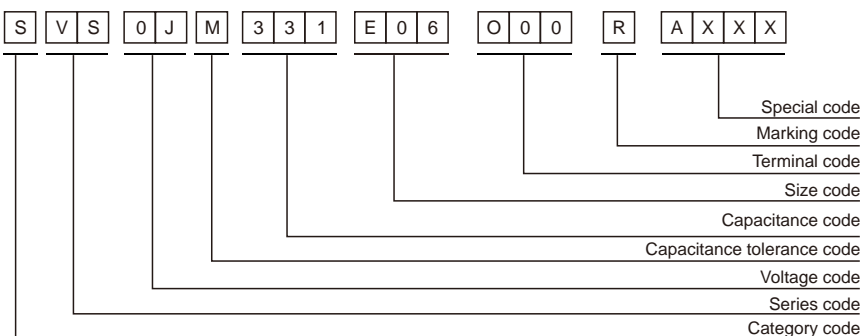

VS series

■ STANDARD RATINGS

VDC (SV)	Cap (μF)	Size DxD(mm)	ESR (mΩ, 20°C, 100kHz) (max.)	Rated ripple current (mArms/105°C, 100kHz)	Leakage Current (μA)(max.)	Part Number
2.5 (2.9)	330	6.3x6	18	2800	500	SVS0EM331E06E00RAXXX
	390	6.3x6	18	2900	500	SVS0EM391E06E00RAXXX
	470	6.3x6	18	4000	500	SVS0EM471E06E00RAXXX
	560	6.3x6	18	4000	500	SVS0EM561E06E00RAXXX
	680	6.3x9	13	4500	500	SVS0EM681E09E00RAXXX
6.3 (7.2)	220	6.3x6	18	2900	500	SVS0JM221E06E00RAXXX
	270	6.3x6	18	3100	500	SVS0JM271E06E00RAXXX
	330	6.3x6	18	3200	500	SVS0JM331E06E00RAXXX
	470	6.3x9	13	3600	592	SVS0JM471E09E00RAXXX
	560	6.3x9	13	3800	706	SVS0JM561E09E00RAXXX
	1000	8x11.5	13	4500	1260	SVS0JM102FBRE00RAXXX
	1500	8x11.5	13	4600	1890	SVS0JM152FBRE00RAXXX
2200	10x12.5	13	5800	2772	SVS0JM222GCRE00RAXXX	
10 (11.5)	68	6.3x6	45	2800	500	SVS1AM680E06E00RAXXX
	120	6.3x6	27	2800	500	SVS1AM121E06E00RAXXX
	220	6.3x6	27	2800	500	SVS1AM221E06E00RAXXX
		6.3x9	18	3100	500	SVS1AM221E09E00RAXXX
	330	6.3x9	18	3200	660	SVS1AM331E09E00RAXXX
		6.3x9	27	3500	940	SVS1AM471E09E00RAXXX
	560	8x11.5	18	3700	1120	SVS1AM561FBRE00RAXXX
		10x12.5	18	5200	1120	SVS1AM561GCRE00RAXXX
	1000	8x11.5	13	4400	2000	SVS1AM102FBRE00RAXXX
		10x12.5	13	4600	2000	SVS1AM102GCRE00RAXXX
	1500	10x12.5	13	4600	3000	SVS1AM152GCRE00RAXXX
16 (18.4)	47	6.3x6	36	1700	500	SVS1CM470E06E00RAXXX
	68	6.3x6	36	2100	500	SVS1CM680E06E00RAXXX
	100	6.3x6	27	2500	500	SVS1CM101E06E00RAXXX
	150	6.3x6	27	2500	500	SVS1CM151F06E00RAXXX
		6.3x9	22	2700	500	SVS1CM151F09E00RAXXX
	180	6.3x6	54	2600	576	SVS1CM181E06E00RAXXX
		6.3x9	22	2800	576	SVS1CM181E09E00RAXXX
	220	6.3x9	22	2600	704	SVS1CM221E09E00RAXXX
		6.3x9	22	2700	864	SVS1CM271E09E00RAXXX
	270	8x9.5	22	2900	864	SVS1CM271F9E00RAXXX
		6.3x9	22	2700	1056	SVS1CM331E09E00RAXXX
	330	8x11.5	18	4200	1056	SVS1CM331FBRE00RAXXX
		10x12.5	18	5200	1056	SVS1CM331GCRE00RAXXX
	560	8x11.5	18	3600	1792	SVS1CM561FBRE00RAXXX
	680	10x12.5	18	4200	2176	SVS1CM681GCRE00RAXXX
	1000	10x12.5	18	4300	3200	SVS1EM102GCRE00RAXXX
25 (28.8)	27	6.3x6	45	1100	500	SVS1EM270E06E00RAXXX
	47	6.3x6	45	1800	500	SVS1EM470E06E00RAXXX
		6.3x9	31	2100	500	SVS1EM470E09E00RAXXX
	56	6.3x6	45	1800	500	SVS1EM560E06E00RAXXX
	68	6.3x6	45	1800	500	SVS1EM680E06E00RAXXX
		6.3x9	27	2500	500	SVS1EM101E09E00RAXXX
	100	6.3x6	45	2200	500	SVS1EM101E06E00RAXXX
		6.3x9	27	2600	750	SVS1EM151E09E00RAXXX
	220	6.3x9	27	2600	1100	SVS1EM221E09E00RAXXX
		8x11.5	27	2700	1100	SVS1EM221FBRE00RAXXX
	330	10x12.5	19	2900	1650	SVS1EM331GCRE00RAXXX
		8x11.5	27	2800	1650	SVS1EM331FBRE00RAXXX
	470	8x11.5	27	2900	2350	SVS1EM471FBRE00RAXXX
		10x12.5	19	3200	2350	SVS1EM471GCRE00RAXXX
	560	10x12.5	19	3400	2800	SVS1EM561GCRE00RAXXX
	680	10x12.5	19	3400	3400	SVS1EM681GCRE00RAXXX

Specifications subject to change without notice.

VD series

- Endurance: +105°C 2,000 hours
- High voltage
- Recommended Applications: Lamps and small LED power supply
- RoHS Compliant and lead-free



SPECIFICATIONS

Items	Characteristics			
Category Temperature Range	-55~+105°C			
Rated Working Voltage Range	35~63 V _{dc}			
Nominal Capacitance Range	22~470μF			
Capacitance Tolerance	±20%(M) (at 20°C,120Hz)			
DC Leakage Current	I ≤ 0.2CV or 500μA, whichever is greater. Where, I:Max.leakage current (μA),C:Nominal capacitance (μF),V: Rated voltage (V) (at 20°C after 2 minutes)			
Dissipation Factor (tan δ)	Rated Voltage(V _{dc})	35	50	63
	tan δ (max.)	0.12 (at 20°C,120Hz)		
ESR(100kHz,20°C)	Value in characteristics table			
Temperature Characteristic (Impedance Ratio at 100kHz)	Z(+105°C)/Z(+20°C) 1.25 Z(-55°C)/Z(+20°C) 1.25			
Endurance	After applying rated voltage for 2,000 hours at 105°C, the capacitors shall meet the following requirements.			
	Appearance	No significant damage		
	Capacitance Change	±20% of the initial value		
	D.F. (tan δ)	150% of the initial specified value		
	ESR	150% of the initial specified value		
Leakage Current	The initial specified value			
Humidity Test	After subjecting to 90~95% RH for 2,000 hours at 60°C without voltage applied, the capacitors shall meet the specified values for the Endurance characteristics listed above.			
Surge Test	After subjecting to 1,000 cycles each consisting of charge with the surge voltage specified at normal temperature for 30 seconds through a protective resistor and discharge for 5 minutes 30 seconds, the capacitors shall meet the following requirements.			
	Appearance	No significant damage		
	Capacitance Change	±20% of the initial value		
	D.F. (tan δ)	150% of the initial specified value		
	ESR	150% of the initial specified value		
Leakage Current	The initial specified value			

*Note: If any doubt arises, measure the leakage current after the following voltage treatment.
Voltage treatment: DC rated voltage is applied to the capacitors for 120 minutes at 105°C.

DIMENSIONS[mm]

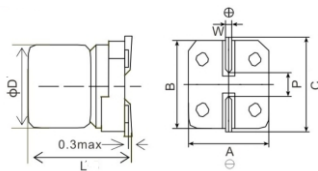

D	6.3	8	10
P±0.2	1.9	3.1	4.5
A±0.2	6.6	8.3	10.3
B±0.2	6.6	8.3	10.3
C±0.2	7.2	9.0	11.0
W	0.5~0.8	0.7~1.1	0.7~1.1
ØD'	ØD-0.1~+0.5	ØD-0.1~+0.5	ØD-0.1~+0.5
L'	L±0.5	L±0.3	L±0.3

PART NUMBERING SYSTEM

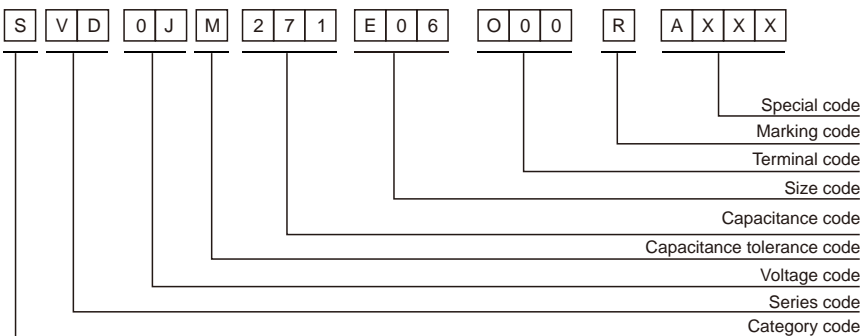

VD series

■ STANDARD RATINGS

VDC (SV)	Cap (μF)	Size DxDL(mm)	ESR (mΩ, 20°C, 100kHz) (max.)	Rated ripple current (mArms/105°C, 100kHz)	Leakage Current (μA)(max.)	Part Number
35 (40.3)	22	6.3x6	54	1100	500	SVD1VM220E06E00RAXXX
	27	6.3x6	54	1100	500	SVD1VM270E06E00RAXXX
	33	6.3x6	54	1100	500	SVD1VM330E06E00RAXXX
	47	6.3x9	45	1500	500	SVD1VM470E09E00RAXXX
		6.3x6	40	1100	500	SVD1VM470E06E00RAXXX
	68	6.3x6	40	1100	500	SVD1VM680E06E00RAXXX
		6.3x9	36	1800	500	SVD1VM680E09E00RAXXX
	100	6.3x9	36	2200	700	SVD1VM101E09E00RAXXX
		8x9.5	36	2900	700	SVD1VM101F9RE00RAXXX
	150	8x11.5	27	3100	700	SVD1VM101FBRE00RAXXX
		8x11.5	27	3100	1050	SVD1VM151FBRE00RAXXX
	220	8x11.5	27	2500	1540	SVD1VM221FBRE00RAXXX
	270	8x11.5	27	2600	1890	SVD1VM271FBRE00RAXXX
		10x12.5	27	2800	1890	SVD1VM271GCRE00RAXXX
330	10x12.5	27	2800	2310	SVD1VM331GCRE00RAXXX	
470	10x12.5	27	3100	3290	SVD1VM471GCRE00RAXXX	
50 (57.5)	22	6.3x6	72	840	500	SVD1HM220E06E00RAXXX
	33	6.3x6	72	890	500	SVD1HM330E06E00RAXXX
	47	6.3x9	54	1400	500	SVD1HM470E09E00RAXXX
	68	8x11.5	27	2100	680	SVD1HM680FBRE00RAXXX
	82	10x12.5	27	2100	820	SVD1HM820GCRE00RAXXX
		8x11.5	27	2100	820	SVD1HM820FBRE00RAXXX
	100	8x9.5	54	1500	1000	SVD1HM101F9RE00RAXXX
		8x11.5	27	2100	1000	SVD1HM101FBRE00RAXXX
	120	10x12.5	27	2200	1000	SVD1HM101GCRE00RAXXX
		8x11.5	27	2100	1200	SVD1HM121FBRE00RAXXX
	150	10x12.5	27	2200	1500	SVD1HM151GCRE00RAXXX
	220	10x12.5	27	2400	2200	SVD1HM221GCRE00RAXXX
63 (72.5)	22	6.3x6	72	520	500	SVD1JM220E06E00RAXXX
	33	6.3x9	54	520	500	SVD1JM330E09E00RAXXX
	47	8x9.5	54	1000	592	SVD1JM470F9RE00RAXXX
	56	8x11.5	36	1000	706	SVD1JM560FBRE00RAXXX
	100	10x12.5	36	1600	1260	SVD1JM101GCRE00RAXXX

Specifications subject to change without notice.

VT series

- Endurance: +125°C 2,000 hours
- High Temperature Resistance
- Recommended Applications: Lamps Power, LED Power, Service Equipment
- **RoHS Compliant and lead-free**



SPECIFICATIONS

Items	Characteristics	
Category Temperature Range	-55~+125°C	
Rated Working Voltage Range	2.5~63 V _{dc}	
Nominal Capacitance Range	22~2200μF	
Capacitance Tolerance	±20%(M) (at 20°C, 120Hz)	
DC Leakage Current	LC=0.2CV when LC 500, LC=500 (at 20°C after 2 minutes) Where, I:Max.leakage current(μA), C:Nominal capacitance(μF), V:Rated voltage(V)	
Dissipation Factor (tan δ)	Rated Voltage(V _{dc})	2.5 6.3 10 16 25 35 50 63
	tan δ (max.)	0.08 0.12 (at 20°C, 120Hz)
ESR(100kHz, 20°C)	Value in characteristics table	
Temperature Characteristic (Impedance Ratio at 100kHz)	Z(+125°C)/Z(+20°C) 1.25 Z(-55°C)/Z(+20°C) 1.25	
Endurance	After applying rated voltage for 2,000 hours at 125°C, the capacitors shall meet the following requirements.	
	Appearance	No significant damage
	Capacitance Change	±20% of the initial value
	D.F. (tan δ)	150% of the initial specified value
	ESR	150% of the initial specified value
Leakage Current	The initial specified value	
Humidity Test	After subjecting to 90%~95% RH for 2,000 hours at 60°C without voltage applied, the capacitors shall meet the specified values for the endurance characteristics listed above.	
Surge Test	After subjecting to 1,000 cycles each consisting of charge with the surge voltage specified at normal temperature for 30 seconds through a protective resistor and discharge for 5 minutes 30 seconds, the capacitors shall meet the following requirements.	
	Appearance	No significant damage
	Capacitance Change	±20% of the initial value
	D.F. (tan δ)	150% of the initial specified value
	ESR	150% of the initial specified value
Leakage Current	The initial specified value	

*Note: If any doubt arises, measure the leakage current after the following voltage treatment.
Voltage treatment: DC rated voltage is applied to the capacitors for 120 minutes at 105°C.

DIMENSIONS[mm]

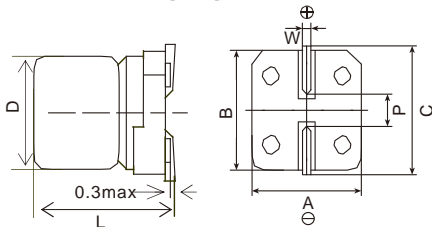

Size Code	6.3	8	10
P±0.2	1.9	3.1	4.5
A±0.2	6.6	8.3	10.3
B±0.2	6.6	8.3	10.3
C±0.2	7.2	9.0	11.0
W	0.5~0.8	0.7~1.1	0.7~1.1
ØD'	ØD -0.1~+0.5		
L'	L±0.5	L±0.3	

PART NUMBERING SYSTEM

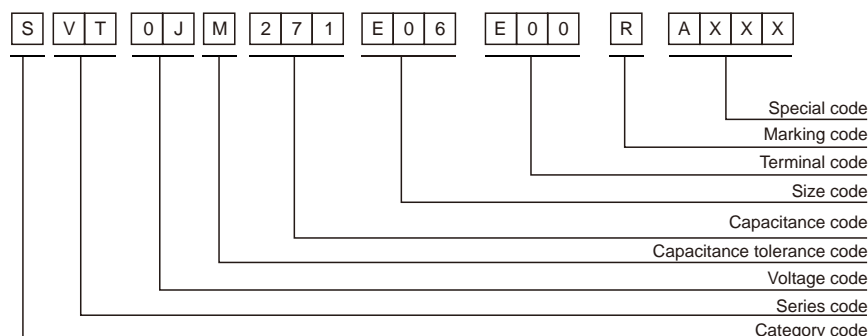

Conductive Polymer SMD Type

VT series

■ STANDARD RATINGS

VDC (SV)	Cap (μF)	Size DxL(mm)	ESR (mΩ, 20°C, 100kHz) (max.)	Rated ripple current (mArms/125°C, 100kHz)	Leakage Current (μA)(max.)	Part Number
2.5 (2.9)	220	6.3x4.5	30	800	500	SVT0EM221E4RE00RAXXX
	330	6.3x4.5	27	100	500	SVT0EM331E4RE00RAXXX
	390	6.3x6	30	800	500	SVT0EM331E06E00RAXXX
	470	6.3x6	30	800	500	SVT0EM391E06E00RAXXX
	560	6.3x6	30	800	500	SVT0EM471E06E00RAXXX
	680	6.3x9	22	900	500	SVT0EM561E06E00RAXXX
6.3 (7.2)	220	6.3x4.5	30	800	500	SVT0JM221E4RE00RAXXX
	330	6.3x6	30	800	500	SVT0JM221E06E00RAXXX
	270	6.3x6	30	900	500	SVT0JM271E06E00RAXXX
	330	6.3x6	30	900	500	SVT0JM331E06E00RAXXX
	470	6.3x9	22	1000	592	SVT0JM471E09E00RAXXX
	560	6.3x9	22	1100	706	SVT0JM561E09E00RAXXX
	1000	8x11.5	22	1200	1260	SVT0JM102FBRE00RAXXX
	1500	8x11.5	22	1300	1890	SVT0JM152FBRE00RAXXX
10 (11.5)	2200	10x12.5	22	1600	2772	SVT0JM222GCRE00RAXXX
	120	6.3x6	45	800	500	SVT1AM121E06E00RAXXX
	220	6.3x6	45	800	500	SVT1AM221E06E00RAXXX
	330	6.3x9	30	900	500	SVT1AM221E09E00RAXXX
	560	6.3x9	30	900	660	SVT1AM331E09E00RAXXX
	560	8x11.5	30	1000	1120	SVT1AM561FBRE00RAXXX
	1000	10x12.5	30	1500	1120	SVT1AM561GCRE00RAXXX
	1500	8x11.5	22	1200	2000	SVT1AM102FBRE00RAXXX
16 (18.4)	1000	10x12.5	22	1300	2000	SVT1AM102GCRE00RAXXX
	1500	10x12.5	22	1300	3000	SVT1AM152GCRE00RAXXX
	47	6.3x6	60	500	500	SVT1CM470E06E00RAXXX
	68	6.3x6	60	600	500	SVT1CM680E06E00RAXXX
	100	6.3x6	45	700	500	SVT1CM101E06E00RAXXX
	150	6.3x6	45	700	500	SVT1CM151E06E00RAXXX
	180	6.3x9	37	700	500	SVT1CM151E09E00RAXXX
	180	6.3x6	90	700	576	SVT1CM181E06E00RAXXX
	220	6.3x9	37	800	576	SVT1CM181E09E00RAXXX
	270	6.3x9	37	700	704	SVT1CM221E09E00RAXXX
25 (28.8)	560	8x11.5	30	1000	1792	SVT1CM561FBRE00RAXXX
	680	10x12.5	30	1200	2176	SVT1CM681GCRE00RAXXX
	1000	10x12.5	30	1200	3200	SVT1CM102GCRE00RAXXX
	27	6.3x6	75	300	500	SVT1EM270E06E00RAXXX
	47	6.3x6	75	500	500	SVT1EM470E06E00RAXXX
	56	6.3x9	52	600	500	SVT1EM470E09E00RAXXX
	68	6.3x6	75	500	500	SVT1EM560E06E00RAXXX
	100	6.3x4.5	90	300	500	SVT1EM680E4RE00RAXXX
	150	6.3x6	75	600	500	SVT1EM101E06E00RAXXX
	220	6.3x9	45	700	500	SVT1EM101E09E00RAXXX
35 (40.3)	150	6.3x9	45	700	750	SVT1EM151E09E00RAXXX
	220	8x11.5	45	700	1100	SVT1EM221FBRE00RAXXX
	330	8x11.5	45	800	1650	SVT1EM331FBRE00RAXXX
	330	10x12.5	45	800	1650	SVT1EM331GCRE00RAXXX
	470	10x12.5	33	900	2350	SVT1EM471GCRE00RAXXX
	22	6.3x6	90	300	500	SVT1VM220E06E00RAXXX
	27	6.3x6	90	300	500	SVT1VM270E06E00RAXXX
	33	6.3x6	90	300	500	SVT1VM330E06E00RAXXX
	47	6.3x6	67	300	500	SVT1VM470E06E00RAXXX
	68	6.3x9	75	400	500	SVT1VM470E09E00RAXXX
50 (57.5)	68	6.3x9	60	500	500	SVT1VM680E09E00RAXXX
	100	6.3x9	60	600	700	SVT1VM101E09E00RAXXX
	150	8x11.5	45	900	700	SVT1VM101FBRE00RAXXX
	150	8x11.5	45	900	1050	SVT1VM151FBRE00RAXXX
	220	8x11.5	45	700	1540	SVT1VM221FBRE00RAXXX
	270	8x11.5	45	700	1890	SVT1VM271FBRE00RAXXX
	330	10x12.5	45	800	1890	SVT1VM271GCRE00RAXXX
	330	10x12.5	45	800	2310	SVT1VM331GCRE00RAXXX
	470	10x12.5	45	900	3290	SVT1VM471GCRE00RAXXX
	22	6.3x6	120	240	500	SVT1HM220E06E00RAXXX
63 (72.5)	33	6.3x6	120	250	500	SVT1HM330E06E00RAXXX
	47	6.3x9	90	400	500	SVT1HM470E09E00RAXXX
	82	10x12.5	45	600	820	SVT1HM820GCRE00RAXXX
	100	8x11.5	45	600	1000	SVT1HM101FBRE00RAXXX
	120	8x11.5	45	600	1200	SVT1HM121FBRE00RAXXX
	220	10x12.5	45	600	2200	SVT1HM221GCRE00RAXXX
22	6.3x6	120	130	500	SVT1JM220E06E00RAXXX	
33	6.3x9	90	150	500	SVT1JM330E09E00RAXXX	
56	8x11.5	60	400	706	SVT1JM560FBRE00RAXXX	
100	10x12.5	60	400	1260	SVT1JM101GCRE00RAXXX	

DA series

- Endurance: +125°C 4,000 hours
- Low ESR, high voltage resistant
- RoHS Compliant

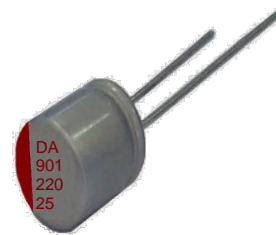

SPECIFICATIONS

Items	Characteristics						
Category Temperature Range	-55~+125°C						
Rated Working Voltage Range	25~80 V _{dc}						
Nominal Capacitance Range	15~470μF						
Capacitance Tolerance	±20%(M) (at 20°C, 120Hz)						
DC Leakage Current	LC=0.01CV or 3(μA), whichever is greater. (at 20°C after 2 minutes) Where, I: Max. leakage current (μA), C: Nominal capacitance (μF), V: Rated voltage (V)						
Dissipation Factor (tan δ)	Rated Voltage(V _{dc})	25	35	50	63	80	(at 20°C, 120Hz)
	tan δ (max.)	0.12					
ESR(100kHz, 20°C)	Value in standard ratings						
Temperature Characteristic (Impedance Ratio at 100kHz)	Z(+125°C)/Z(+20°C) 1.5						
	Z(-55°C)/Z(+20°C) 2.0						
Endurance	After applying rated voltage with rated ripple current for 4,000 hours at 125°C, the capacitors shall meet the following requirements						
	Appearance	No significant damage					
	Capacitance Change	±30% of the initial value					
	D.F. (tan δ)	200% of the initial specified value					
	ESR	200% of the initial specified value					
	Leakage Current	The initial specified value					
High Temperature Storage (No-Load)	The requirements for the Endurance characteristics listed above shall be satisfied when the capacitors are restored to normal temperature after storing them for 2,000 hours under no-load at 125°C±2°C.						
Humidity Resistance (On-Load)	After applying rated voltage for 2,000 hours at 85°C±2°C and 85~90%RH, the capacitors shall meet the following requirements.						
	Appearance	No significant damage					
	Capacitance Change	±30% of the initial value					
	D.F. (tan δ)	200% of the initial specified value					
	ESR	200% of the initial specified value					
	Leakage Current	The initial specified value					

Conductive Polymer Hybrid Type

DIMENSIONS [mm]

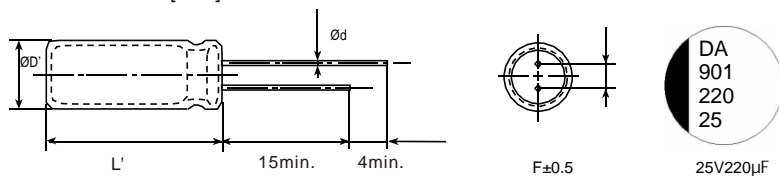

ØD	6.3	8	10
Ød	0.5	0.6	0.6
F	2.5	3.5	5.0
ØD'	ØD-0.1~+0.5max.		
L'	L +1.0max.	L -0.5~+1	

PART NUMBERING SYSTEM

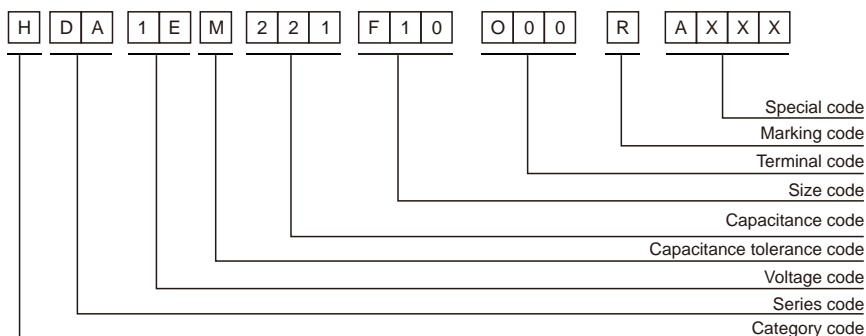

DA series

STANDARD RATINGS

VDC (SV)	Cap (μF)	Size D×L(mm)	ESR (mΩ, 20°C, 100kHz) (max.)	Rated ripple current (mA _{rms} /125°C, 100kHz)	Leakage Current (μA)(max.)	Part Number
25 (28.8)	100	6.3×7	35	1200	25	HDA1EM101E07O00RAXXX
	220	8×10	27	1400	55	HDA1EM221F10O00RAXXX
	330	10×10	25	1800	82.5	HDA1EM331G10O00RAXXX
	470	10×10	20	2000	117.5	HDA1EM471G10O00RAXXX
35 (40.3)	47	6.3×7	40	1100	16.5	HDA1VM470E07O00RAXXX
	68	6.3×8	40	1200	23.8	HDA1VM680E08O00RAXXX
	120	8×10	35	1400	42	HDA1VM121F10O00RAXXX
	220	10×10	30	1800	77	HDA1VM221G10O00RAXXX
50 (57.5)	22	6.3×8	90	900	11	HDA1HM220E08O00RAXXX
	47	8×10	35	1100	23.5	HDA1HM470F10O00RAXXX
	100	10×10	35	1400	50	HDA1HM101G10O00RAXXX
63 (72.5)	15	6.3×8	100	800	9.5	HDA1JM150E08O00RAXXX
	33	8×10	50	1000	20.8	HDA1JM330F10O00RAXXX
	56	10×10	40	1200	35.3	HDA1JM560G10O00RAXXX
80 (92.0)	47	8×12	40	1000	37.6	HDA1BM470F12O00RAXXX

Frequency Coefficient of Rated Ripple Current

Frequency(Hz)	120	1k	10k	100k
Coefficient	0.05	0.30	0.70	1.00

SA series

- Endurance: +125°C 4,000 hours
- Low ESR, high ripple current resistant
- RoHS Compliant



SPECIFICATIONS

Items	Characteristics						
Category Temperature Range	-55~+125°C						
Rated Working Voltage Range	25~80 V _{dc}						
Nominal Capacitance Range	15~470µF						
Capacitance Tolerance	±20%(M) (at 20°C, 120Hz)						
DC Leakage Current	LC=0.01CV or 3(µA), whichever is greater. (at 20°C after 2 minutes)						
	Where, I:Max.leakage current (µA),C:Nominal capacitance (µF),V: Rated voltage (V)						
Dissipation Factor (tan)	Rated Voltage(V _{dc})	25	35	50	63	80	(at 20°C, 120Hz)
	tan (max.)	0.12					
ESR(100kHz,20°C)	Value in standard ratings						
Temperature Characteristic (Impedance Ratio at 100kHz)	Z(+125°C)/Z(+20°C) 1.5						
	Z(-55°C)/Z(+20°C) 2.0						
Endurance	After applying rated voltage with rated ripple current for 4,000 hours at 125°C, the capacitors shall meet the following requirements						
	Appearance	No significant damage					
	Capacitance Change	±30% of the initial value					
	D.F. (tan)	200% of the initial specified value					
	ESR	200% of the initial specified value					
	Leakage Current	The initial specified value					
High Temperature Storage (No-Load)	The requirements for the Endurance characteristics listed above shall be satisfied when the capacitors are restored to normal temperature after storing them for 2,000 hours under no-load at 125°C±2°C.						
Humidity Resistance (On-Load)	After applying rated voltage for 2,000 hours at 85°C±2°C and 85~90%RH, the capacitors shall meet the following requirements.						
	Appearance	No significant damage					
	Capacitance Change	±30% of the initial value					
	D.F. (tan)	200% of the initial specified value					
	ESR	200% of the initial specified value					
	Leakage Current	The initial specified value					

Conductive Polymer Hybrid Type

DIMENSIONS[mm]

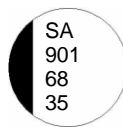
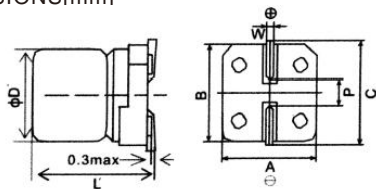

Size Code	6.3	8	10
P±0.2	1.9	3.1	4.5
A±0.2	6.6	8.3	10.3
B±0.2	6.6	8.3	10.3
C±0.2	7.2	9.0	11.0
W	0.5~0.8	0.7~1.1	0.7~1.1
ØD'	ØD-0.1~+0.5		
L'	L±0.3	L±0.5	

PART NUMBERING SYSTEM

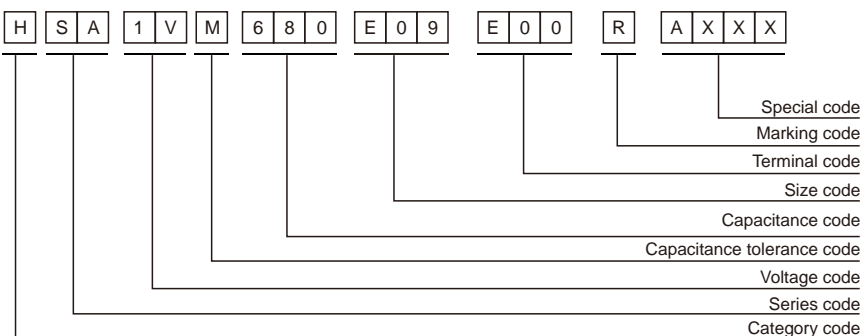

SA series

STANDARD RATINGS

VDC (SV)	Cap (μF)	Size D×L(mm)	ESR (mΩ, 20°C, 100kHz) (max.)	Rated ripple current (mA _{rms} /125°C, 100kHz)	Leakage Current (μA)(max.)	Part Number
25 (28.8)	100	6.3× 8	35	1200	25	HSA1EM101E08E00RAXXX
	220	8× 10.5	27	1400	55	HSA1EM221FARE00RAXXX
	330	10× 10.5	25	1800	82.5	HSA1EM331GARE00RAXXX
	470	10× 10.5	20	2000	117.5	HSA1EM471GARE00RAXXX
35 (40.3)	47	6.3× 8	40	1100	16.5	HSA1VM470E08E00RAXXX
	68	6.3× 9	40	1200	23.8	HSA1VM680E09E00RAXXX
	120	8× 10.5	35	1400	42	HSA1VM121FARE00RAXXX
	220	10× 10.5	30	1800	77	HSA1VM221GARE00RAXXX
50 (57.5)	22	6.3× 8	90	900	11	HSA1HM220E08E00RAXXX
	47	8× 10.5	35	1100	23.5	HSA1HM470FARE00RAXXX
	100	10× 10.5	35	1400	50	HSA1HM101GARE00RAXXX
63 (72.5)	15	6.3× 9	100	800	9.5	HSA1JM150E09E00RAXXX
	33	8× 10.5	50	1000	20.8	HSA1JM330FARE00RAXXX
	56	10× 10.5	40	1200	35.3	HSA1JM560GARE00RAXXX
80 (92.0)	47	8× 12.5	40	1000	37.6	HSA1BM470FCRE00RAXXX

Frequency Coefficient of Rated Ripple Current

Frequency(Hz)	120	1k	10k	100k
Coefficient	0.05	0.30	0.70	1.00

MK series

- Endurance: +105°C 2,000 ~ 3,000 hours
- Designed for surface mounting on high density PC board
- RoHS Compliant



SPECIFICATIONS

Items	Characteristics	
Category Temperature Range	-40~+105°C(6.3 ~450 V _{dc})	
Rated Voltage Range	6.3~450 V _{dc}	
Capacitance Tolerance	±20%(M) (at 20°C,120Hz)	
Leakage Current	6.3~100 V _{dc}	160~450 V _{dc}
	I 0.01CV or 3μA, whichever is greater. (2 minutes) I 0.04CV+100μA (1 minute)	
Where, I:Max.leakage current (μA),C:Nominal capacitance (μF),V: Rated voltage (V) (at 20°C)		
Dissipation Factor (tan)	Rated Voltage(V _{dc})	6.3 10 16 25 35 50 63 80 100 160~250 400~450
	tan (max.)	D80~E80 0.30 0.24 0.20 0.16 0.14 0.12 0.12 0.12 0.12 0.15 0.20 EB0~WM5 0.40 0.30 0.26 0.16 0.14 0.12 0.12 0.12 0.12 0.15 0.20 (at 20°C,120Hz)
Low Temperature Characteristics (Max. Impedance Ratio)	Rated Voltage(V _{dc})	6.3 10 16 25 35 50 63 80 100 160~250 400~450
	Z(-25°C)/Z(+20°C)	4 3 2 2 2 2 2 2 2 6 6
	Z(-40°C)/Z(+20°C)	10 8 6 4 3 3 3 3 3 10 18 (at 120Hz)
Endurance	The specifications listed below shall be met when the capacitors are restored to 20°C after rated voltage is applied for a specified period of time at 105°C.	
	Load Life	2,000 hours(160~450V _{dc} 3,000 hours)
	Capacitance Change	±20% of the initial value
	Dissipation Factor (tan)	200% of the initial specified value
Shelf Life	The following specifications shall be satisfied when the capacitors are restored to 20°C after leaving them under no load at 105°C for 1,000 hours (6.3~100V _{dc} : 500 hours).	
	Capacitance Change	±20% of the initial value
	Dissipation Factor (tan)	200% of the initial specified value
	Leakage Current	200% of the initial specified value

DIMENSIONS[mm]

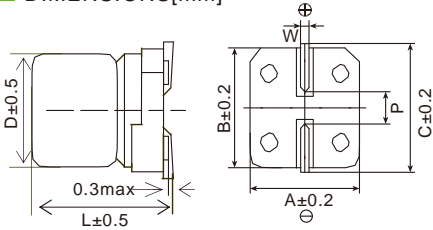

Size code	D	L	A	B	C	W	P
D80	5	7.7	5.3	5.3	5.9	0.5~0.8	1.4
E80	6.3	7.7	6.6	6.6	7.2	0.5~0.8	1.9
E83	6.3	8.0	6.6	6.6	7.2	0.5~0.8	1.9
EB0	6.3	10.5	6.6	6.6	7.2	0.5~0.8	1.9
FB0	8	10.5	8.3	8.3	9.0	0.7~1.1	3.1
FD0	8	12.5	8.3	8.3	9.0	0.7~1.1	3.1
FE0	8	13.5	8.3	8.3	9.0	0.7~1.1	3.1
FG0	8	15.5	8.3	8.3	9.0	0.7~1.1	3.1
G80	10	7.7	10.3	10.3	11.0	0.7~1.1	4.5
GB0	10	10.5	10.3	10.3	11.0	0.7~1.1	4.5
GD0	10	12.5	10.3	10.3	11.0	0.7~1.1	4.5
GE0	10	13.5	10.3	10.3	11.0	0.7~1.1	4.5
GH0	10	16.5	10.3	10.3	11.0	0.7~1.1	4.5
WE0	12.5	13.5	13.0	13.0	13.7	1.0~1.3	4.5
WG5	12.5	16.0	13.0	13.0	13.7	1.0~1.3	4.5
WM5	12.5	21.0	13.0	13.0	13.7	1.0~1.3	4.5

Note: Tolerance shall be L+1.3(max.) for G80.

PART NUMBERING SYSTEM

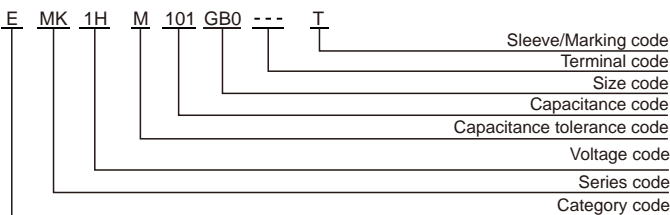

RATED RIPPLE CURRENT MULTIPLIERS

Frequency correction factor for ripple current

Rated voltage(V _{dc}) \ Freq.(Hz)	120	1k	10k	100k
6.3~450	0.50	0.80	0.90	1.00

MK series

■ STANDARD RATINGS (Rated ripple current:mArms/105°C 100kHz)

WV (Vdc)	Cap (μF)	Size code	Rated ripple current	Part Number
6.3(0J)	100	D80	105	EMK0JM101D80D00T
	220	E83	160	EMK0JM221E83D00T
	330	FB0	340	EMK0JM331FB0D00T
	1000	GB0	860	EMK0JM102GB0D00T
10(1A)	33	D80	105	EMK1AM330D80D00T
	100	E83	175	EMK1AM101E83D00T
	220	E83	180	EMK1AM221E83D00T
	330	FB0	340	EMK1AM331FB0D00T
	470	FB0	360	EMK1AM471FB0D00T
16(1C)	820	GB0	860	EMK1AM821GB0D00T
	47	D80	105	EMK1CM470D80D00T
	100	E83	175	EMK1CM101E83D00T
	150	E83	190	EMK1CM151E83D00T
	220	FB0	500	EMK1CM221FB0D00T
	330	FB0	545	EMK1CM331FB0D00T
25(1E)	470	GB0	800	EMK1CM471GB0D00T
	33	D80	105	EMK1EM330D80D00T
	47	E83	180	EMK1EM470E83D00T
	100	E83	205	EMK1EM101E83D00T
	220	FB0	550	EMK1EM221FB0D00T
35(1V)	330	GB0	780	EMK1EM331GB0D00T
	470	GD0	875	EMK1EM471GD0D00T
	10	D80	105	EMK1VM100D80D00T
	22	D80	110	EMK1VM220D80D00T
	47	E83	210	EMK1VM470E83D00T
	100	FB0	575	EMK1VM101FB0D00T
50(1H)	220	GB0	835	EMK1VM221GB0D00T
	330	GD0	900	EMK1VM331GD0D00T
	10	D80	90	EMK1HM100D80D00T
	22	E83	175	EMK1HM220E83D00T
	33	E83	180	EMK1HM330E83D00T
	47	FB0	540	EMK1HM470FB0D00T
	100	GB0	700	EMK1HM101GB0D00T
63(1J)	220	WE0	900	EMK1HM221WE0D00T
	330	WG5	1180	EMK1HM331WG5D00T
	10	D80	85	EMK1JM100D80D00T
	22	E83	150	EMK1JM220E83D00T
	33	FB0	375	EMK1JM330FB0D00T
	47	FB0	450	EMK1JM470FB0D00T
80(1B)	100	GB0	575	EMK1JM101GB0D00T
	220	WE0	890	EMK1JM221WE0D00T
	10	E80	140	EMK1BM100E80D00T
	22	FB0	375	EMK1BM220FB0D00T
	33	FB0	450	EMK1BM330FB0D00T
	47	GB0	575	EMK1BM470GB0D00T
100(1K)	100	GD0	600	EMK1BM101GD0D00T
	150	WE0	800	EMK1BM151WE0D00T
	220	WG5	960	EMK1BM221WG5D00T
	4.7	D80	70	EMK1KM470D80D00T
	10	E83	135	EMK1KM100E83D00T
100(1K)	22	FB0	345	EMK1KM220FB0D00T
	33	GB0	560	EMK1KM330GB0D00T
	47	GB0	575	EMK1KM470GB0D00T
	100	WE0	680	EMK1KM101WE0D00T

WV (Vdc)	Cap (μF)	Size code	Rated ripple current	Part Number
160(2C)	10	G80	81	EMK2CM100G80D00T
		GB0	90	EMK2CM100GB0D00T
		F00	136	EMK2CM150F00D00T
		G00	170	EMK2CM220G00D00T
		GE0	215	EMK2CM330GE0D00T
		GHO	380	EMK2CM470GHO0D00T
		WM5	630	EMK2CM680WM5D00T
200(2D)	100	WM5	700	EMK2CM101WM5D00T
		G80	110	EMK2DM100G80D00T
		GB0	130	EMK2DM100GB0D00T
		FE0	170	EMK2DM150FE0D00T
		GE0	200	EMK2DM220GE0D00T
		GHO	260	EMK2DM330GHO0D00T
250(2E)	47	WM5	440	EMK2DM470WM5D00T
		WM5	640	EMK2DM680WM5D00T
		E80	52	EMK2EM2R2E80D00T
		E80	68	EMK2EM3R3E80D00T
		F80	96	EMK2EM4R7F80D00T
400(2G)	10	F00	166	EMK2EM100F00D00T
		GHO	300	EMK2EM220GHO0D00T
		WM5	420	EMK2EM330WM5D00T
		WM5	460	EMK2EM470WM5D00T
		E80	28	EMK2GM010E80D00T
		E80	36	EMK2GM1R5E80D00T
		E80	44	EMK2GM2R2E80D00T
450(2W)	4.7	F80	64	EMK2GM3R3F80D00T
		F80	78	EMK2GM4R7F80D00T
		F00	96	EMK2GM5R6F00D00T
		FE0	108	EMK2GM6R8FE0D00T
		FG0	130	EMK2GM8R2FG0D00T
		GE0	140	EMK2GM100GE0D00T
		GHO	174	EMK2GM150GHO0D00T
		WM5	235	EMK2GM220WM5D00T
450(2W)	22	GB0	50	EMK2WM2R2GB0D00T
		GB0	72	EMK2WM3R3GB0D00T
		GE0	90	EMK2WM4R7GE0D00T
		GHO	136	EMK2WM100GHO0D00T
		WM5	180	EMK2WM150WM5D00T
450(2W)	22	WM5	218	EMK2WM220WM5D00T

MF series

- Endurance: +105°C 6,000 hours
- Designed for surface mounting on high density PC board
- RoHS Compliant



SPECIFICATIONS

Items	Characteristics	
Category Temperature Range	-40~+105°C(6.3 ~450 V _{dc})	
Rated Voltage Range	6.3~450 V _{dc}	
Capacitance Tolerance	±20%(M)	
Leakage Current	6.3~100 V _{dc}	160~450 V _{dc}
	I 0.03CV or 4μA, whichever is greater. (2 minutes) I 0.04CV+100μA (1 minute)	
Where, I:Max.leakage current (μA),C:Nominal capacitance (μF),V: Rated voltage (V) (at 20°C)		
Dissipation Factor (tan δ)	Rated Voltage(V _{dc})	6.3 10 16 25 35 50 63 80 100 160~250 400~450
	tan δ (max.)	0.32 0.28 0.26 0.16 0.14 0.14 0.12 0.12 0.10 0.20 0.24 (at 20°C,120Hz)
Low Temperature Characteristics (Max. Impedance Ratio)	Rated Voltage(V _{dc})	6.3 10 16 25 35 50 63 80 100 160~250 400~450
	Z(-25°C)/Z(+20°C)	4 3 2 2 2 2 2 2 2 6 6
	Z(-40°C)/Z(+20°C)	10 8 6 4 3 3 3 3 3 10 18 (at 120Hz)
Endurance	The specifications listed below shall be met when the capacitors are restored to 20°C after rated voltage is applied for 6,000 hours at 105°C.	
	Rated Voltage(V _{dc})	6.3~100 160~450
	Capacitance Change	±30% of the initial value ±20% of the initial value
	Dissipation Factor (tan δ)	300% of the initial specified value 200% of the initial specified value
Shelf Life	The following specifications shall be satisfied when the capacitors are restored to 20°C after leaving them under no load at 105°C for 1,000 hours.	
	Rated Voltage(V _{dc})	6.3~100 160~450
	Capacitance Change	±30% of the initial value ±20% of the initial value
	Dissipation Factor (tan δ)	300% of the initial specified value 200% of the initial specified value
	Leakage Current	200% of the initial specified value 200% of the initial specified value

DIMENSIONS[mm]

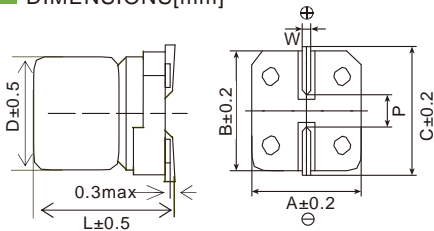

Size code	D	L	A	B	C	W	P
D80	5	7.7	5.5	5.3	5.9	0.5~0.8	1.4
E80	6.3	7.7	6.6	6.6	7.2	0.5~0.8	1.9
E83	6.3	8.0	6.6	6.6	7.2	0.5~0.8	1.9
EB0	6.3	10.5	6.6	6.6	7.2	0.5~0.8	1.9
FB0	8	10.5	8.3	8.3	9.0	0.7~1.1	3.1
FD0	8	12.5	8.3	8.3	9.0	0.7~1.1	3.1
FE0	8	13.5	8.3	8.3	9.0	0.7~1.1	3.1
FG0	8	15.5	8.3	8.3	9.0	0.7~1.1	3.1
G80	10	7.7	10.3	10.3	11.0	0.7~1.1	4.5
GB0	10	10.5	10.3	10.3	11.0	0.7~1.1	4.5
GD0	10	12.5	10.3	10.3	11.0	0.7~1.1	4.5
GE0	10	13.5	10.3	10.3	11.0	0.7~1.1	4.5
WG5	12.5	16.0	13.0	13.0	13.7	1.0~1.3	4.5
WM5	12.5	21.0	13.0	13.0	13.7	1.0~1.3	4.5
LH0	16	16.5	17.0	17.0	18.0	1.0~1.3	6.5
LN0	16	21.5	17.0	17.0	18.0	1.0~1.3	6.5

Note: Tolerance shall be L+1.3(max.) for G80.

PART NUMBERING SYSTEM

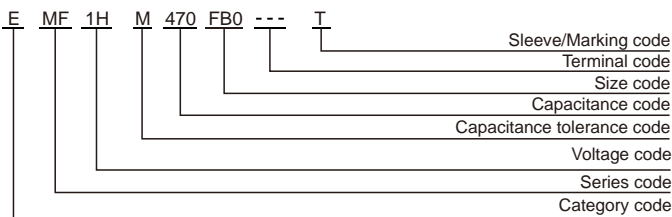

RATED RIPPLE CURRENT MULTIPLIERS

Frequency correction factor for ripple current

Rated voltage(V _{dc}) \ Freq.(Hz)	120	1k	10k	100k
6.3~450	0.50	0.80	0.90	1.00

Surface Mount Type

MF series

■ STANDARD RATINGS (Rated ripple current:mArms/105°C 100kHz)

WV (Vdc)	Cap (µF)	Size code	Rated ripple current	Part Number
6.3(0J)	47	D80	90	EMF0JM470D80D00T
	100	E83	145	EMF0JM101E83D00T
	220	E83	180	EMF0JM221E83D00T
	330	FB0	280	EMF0JM331FB0D00T
	470	FB0	360	EMF0JM471FB0D00T
10(1A)	33	D80	71	EMF1AM330D80D00T
	150	E83	105	EMF1AM151E83D00T
	220	FB0	280	EMF1AM221FB0D00T
	330	GB0	400	EMF1AM331GB0D00T
16(1C)	470	GB0	545	EMF1AM471GB0D00T
	47	D80	90	EMF1CM470D80D00T
	100	E83	145	EMF1CM101E83D00T
	220	FB0	475	EMF1CM221FB0D00T
	330	FD0	510	EMF1CM331FD0D00T
25(1E)	470	GB0	720	EMF1CM471GB0D00T
	33	D80	90	EMF1EM330D80D00T
	47	E83	165	EMF1EM470E83D00T
	100	E83	175	EMF1EM101E83D00T
	220	FB0	535	EMF1EM221FB0D00T
35(1V)	330	GB0	750	EMF1EM331GB0D00T
	10	D80	90	EMF1VM100D80D00T
	22	E83	145	EMF1VM100E83D00T
		D80	96	EMF1VM220D80D00T
	33	E83	160	EMF1VM220E83D00T
		E83	175	EMF1VM330E83D00T
	47	E80	190	EMF1VM470E80D00T
100	FB0	560	EMF1VM101FB0D00T	
220	GB0	800	EMF1VM221GB0D00T	
50(1H)	10	D80	86	EMF1HM100D80D00T
	22	E83	145	EMF1HM220E83D00T
	47	FB0	520	EMF1HM470FB0D00T
	100	GB0	680	EMF1HM101GB0D00T
	220	WE0	875	EMF1HM221WE0D00T
	330	WG5	1020	EMF1HM331WG5D00T
63(1J)	22	E83	140	EMF1JM220E83D00T
	33	FB0	320	EMF1JM330FB0D00T
	47	FB0	380	EMF1JM470FB0D00T
	100	GB0	530	EMF1JM101GB0D00T
	220	WE0	840	EMF1JM221WE0D00T
	330	LH0	1040	EMF1JM331LH0D00T
	470	LNO	1700	EMF1JM471LNO00T
80(1B)	10	E83	130	EMF1BM100E83D00T
	22	FB0	360	EMF1BM220FB0D00T
	33	FB0	410	EMF1BM330FB0D00T
	47	GB0	490	EMF1BM470GB0D00T
	100	GD0	530	EMF1BM101GD0D00T
220	WG5	1020	EMF1BM221WG5D00T	
100(1K)	10	E83	290	EMF1KM100E83D00T
	22	FB0	320	EMF1KM220FB0D00T
	33	GB0	360	EMF1KM330GB0D00T
	47	GB0	540	EMF1KM470GB0D00T
	100	WE0	550	EMF1KM101WE0D00T
220	LH0	1090	EMF1KM221LH0D00T	

WV (Vdc)	Cap (µF)	Size code	Rated ripple current	Part Number
160(2C)	10	G80	155	EMF2CM100G80D00T
		GB0	176	EMF2CM100GB0D00T
	15	FD0	204	EMF2CM150FD0D00T
		GD0	260	EMF2CM220GD0D00T
	33	GE0	340	EMF2CM330GE0D00T
	47	GH0	420	EMF2CM470GH0D00T
	68	WM5	560	EMF2CM680WM5D00T
	100	WM5	610	EMF2CM101WM5D00T
	200(2D)	10	G80	170
GB0			185	EMF2DM100GB0D00T
15		FE0	210	EMF2DM150FE0D00T
		GE0	272	EMF2DM220GE0D00T
33		GH0	340	EMF2DM330GH0D00T
		WE0	340	EMF2DM330WE0D00T
47		WM5	480	EMF2DM470WM5D00T
68	WM5	540	EMF2DM680WM5D00T	
250(2E)	4.7	FB0	90	EMF2EM4R7FB0D00T
	10	FD0	150	EMF2EM100FD0D00T
	22	GH0	312	EMF2EM220GH0D00T
	33	WM5	440	EMF2EM330WM5D00T
400(2G)	47	WM5	510	EMF2EM470WM5D00T
	1	E80	34	EMF2GM010E80D00T
		E80	44	EMF2GM1R5E80D00T
	1.5	E80	44	EMF2GM1R5E80D00T
	2.2	E80	48	EMF2GM2R2E80D00T
	3.3	FB0	72	EMF2GM3R3FB0D00T
	4.7	FD0	100	EMF2GM4R7FD0D00T
		GB0	100	EMF2GM4R7GB0D00T
	5.6	FD0	108	EMF2GM5R6FD0D00T
		GB0	114	EMF2GM5R6GB0D00T
6.8	GE0	140	EMF2GM6R8GE0D00T	
10	GE0	194	EMF2GM100GE0D00T	
15	GH0	235	EMF2GM150GH0D00T	
22	WM5	350	EMF2GM220WM5D00T	
450(2W)	2.2	GB0	60	EMF2WM2R2GB0D00T
	3.3	GB0	75	EMF2WM3R3GB0D00T
	4.7	GE0	98	EMF2WM4R7GE0D00T
	10	GH0	192	EMF2WM100GH0D00T
	15	WM5	240	EMF2WM150WM5D00T
22	WM5	320	EMF2WM220WM5D00T	

MA series

- Endurance: +105°C 10,000 hours
- Designed for surface mounting on high density PC board
- RoHS Compliant



SPECIFICATIONS

Items	Characteristics										
Category Temperature Range	-40~+105°C(16~450 V _{dc})										
Rated Voltage Range	16~450 V _{dc}										
Capacitance Tolerance	±20%(M) (at 20°C,120Hz)										
Leakage Current	16~100 V _{dc}					160~450 V _{dc}					
	I 0.03CV or 4μA, whichever is greater. (2 minutes)					I 0.04CV+100μA (1 minute)					
Where, I:Max.leakage current (μA),C:Nominal capacitance (μF),V: Rated voltage (V) (at 20°C)											
Dissipation Factor (tan δ)	Rated Voltage(V _{dc})	16	25	35	50	63	80	100	160~250	400~450	(at 20°C,120Hz)
	tan (max.)	0.26	0.16	0.14	0.14	0.20	0.20	0.20	0.20	0.24	
Low Temperature Characteristics (Max. Impedance Ratio)	Rated Voltage(V _{dc})	16	25	35	50	63	80	100	160~250	400~450	(at 120Hz)
	Z(-25°C)/Z(+20°C)	2	2	2	2	2	2	2	6	6	
	Z(-40°C)/Z(+20°C)	6	4	3	3	3	3	3	10	18	
Endurance	The specifications listed below shall be met when the capacitors are restored to 20°C after rated voltage is applied for 10,000 hours at 105°C.										
	Rated Voltage(V _{dc})	16~100					160~450				
	Capacitance Change	±30% of the initial value					±20% of the initial value				
	Dissipation Factor (tan δ)	300% of the initial specified value					200% of the initial specified value				
Shelf Life	The following specifications shall be satisfied when the capacitors are restored to 20°C after leaving them under no load at 105°C for 1,000 hours.										
	Rated Voltage(V _{dc})	16~100					160~450				
	Capacitance Change	±30% of the initial value					±20% of the initial value				
	Dissipation Factor (tan δ)	300% of the initial specified value					200% of the initial specified value				
Leakage Current	300% of the initial specified value					200% of the initial specified value					

DIMENSIONS[mm]

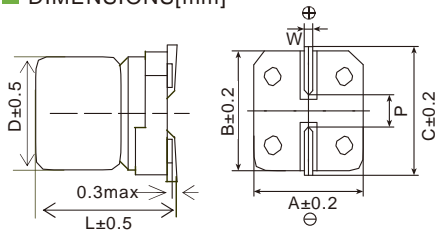

Size code	D	L	A	B	C	W	P
E80	6.3	7.7	6.6	6.6	7.2	0.5~0.8	1.9
E83	6.3	8.0	6.6	6.6	7.2	0.5~0.8	1.9
EB0	6.3	10.5	6.6	6.6	7.2	0.5~0.8	1.9
FB0	8	10.5	8.3	8.3	9.0	0.7~1.1	3.1
FD0	8	12.5	8.3	8.3	9.0	0.7~1.1	3.1
FE0	8	13.5	8.3	8.3	9.0	0.7~1.1	3.1
FG0	8	15.5	8.3	8.3	9.0	0.7~1.1	3.1
GB0	10	10.5	10.3	10.3	11.0	0.7~1.1	4.5
GD0	10	12.5	10.3	10.3	11.0	0.7~1.1	4.5
GE0	10	13.5	10.3	10.3	11.0	0.7~1.1	4.5
GH0	10	16.5	10.3	10.3	11.0	0.7~1.1	4.5
WE0	12.5	13.5	13.0	13.0	13.7	1.0~1.3	4.5
WG5	12.5	16.0	13.0	13.0	13.7	1.0~1.3	4.5
WM5	12.5	21.0	13.0	13.0	13.7	1.0~1.3	4.5

PART NUMBERING SYSTEM

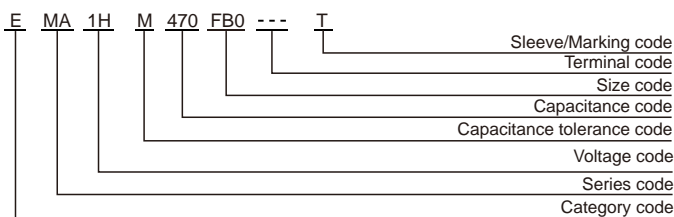

RATED RIPPLE CURRENT MULTIPLIERS

Frequency correction factor for ripple current

Rated voltage(V _{dc})	Freq.(Hz)	120	1k	10k	100k
16~450		0.50	0.80	0.90	1.00

Surface Mount Type

MA series

■ STANDARD RATINGS (Rated ripple current:mArms/105°C 100kHz)

WV (Vdc)	Cap (μF)	Size code	Rated ripple current	Part Number
16(1C)	47	E83	125	EMA1CM470E83D00T
	100	E83	245	EMA1CM101E83D00T
	220	FB0	260	EMA1CM221FB0D00T
	330	GB0	450	EMA1CM331GB0D00T
	470	GD0	480	EMA1CM471GD0D00T
	680	WE0	820	EMA1CM681WE0D00T
	1000	WG5	860	EMA1CM102WG5D00T
25(1E)	47	E83	125	EMA1EM470E83D00T
	100	FB0	245	EMA1EM101FB0D00T
	220	GB0	440	EMA1EM221GB0D00T
	330	GB0	460	EMA1EM331GB0D00T
	470	WE0	820	EMA1EM471WE0D00T
	680	WG5	860	EMA1EM681WG0D00T
35(1V)	33	E83	125	EMA1VM330E83D00T
	47	E83	140	EMA1VM470E83D00T
	100	FB0	245	EMA1VM101FB0D00T
	220	GB0	440	EMA1VM221GB0D00T
	330	WE0	820	EMA1VM331WE0D00T
	470	WG5	860	EMA1VM471WG5D00T
50(1H)	10	E83	100	EMA1HM100E83D00T
	22	E83	105	EMA1HM220E83D00T
	33	E83	110	EMA1HM330E83D00T
	47	FB0	260	EMA1HM470FB0D00T
	100	GB0	400	EMA1HM101GB0D00T
	220	WE0	800	EMA1HM221WE0D00T
	330	WG5	845	EMA1HM331WG5D00T
	63(1J)	22	E83	95
33		FB0	180	EMA1JM330FB0D00T
47		FB0	210	EMA1JM470FB0D00T
100		GD0	420	EMA1JM101GD0D00T
220		WG5	820	EMA1JM221WG5D00T
80(1B)	10	FB0	165	EMA1BM100FB0D00T
	22	FB0	180	EMA1BM220FB0D00T
	33	GB0	305	EMA1BM220GB0D00T
	33	FB0	190	EMA1BM330FB0D00T
	47	GB0	350	EMA1BM470GB0D00T
	100	WE0	760	EMA1BM101WE0D00T
100(1K)	10	E83	150	EMA1KM100E83D00T
	22	FB0	165	EMA1KM220FB0D00T
	33	GB0	280	EMA1KM330GB0D00T
	47	GB0	320	EMA1KM470GB0D00T
	68	GD0	350	EMA1KM680GD0D00T
	82	WE0	530	EMA1KM820WE0D00T
	100	WE0	555	EMA1KM101WE0D00T

WV (Vdc)	Cap (μF)	Size code	Rated ripple current	Part Number
160(2C)	10	GB0	190	EMA2CM100GB0D00T
	15	FD0	220	EMA2CM150FD0D00T
	22	GD0	340	EMA2CM220GD0D00T
	33	GE0	420	EMA2CM330GE0D00T
	47	GH0	530	EMA2CM470GH0D00T
	68	WM5	640	EMA2CM680WM5D00T
	100	WM5	840	EMA2CM101WM5D00T
	200(2D)	10	FD0	180
15		GB0	198	EMA2DM150GB0D00T
22		GD0	240	EMA2DM220GD0D00T
33		GE0	350	EMA2DM330GE0D00T
47		GH0	440	EMA2DM470GH0D00T
68		WM5	576	EMA2DM680WM5D00T
100		WM5	670	EMA2DM101WM5D00T
250(2E)	4.7	FB0	120	EMA2EM477FB0D00T
	10	FE0	180	EMA2EM100FE0D00T
	22	GB0	200	EMA2EM220GB0D00T
	33	GH0	360	EMA2EM330GH0D00T
	47	WM5	435	EMA2EM477WM5D00T
	100	WM5	600	EMA2EM101WM5D00T
400(2G)	2.2	FB0	60	EMA2GM2R2FB0D00T
	3.3	FB0	76	EMA2GM3R3FB0D00T
	4.7	FE0	124	EMA2GM477FE0D00T
	10	GB0	124	EMA2GM477GB0D00T
	5.6	GE0	160	EMA2GM5R6GE0D00T
	6.8	GE0	176	EMA2GM6R8GE0D00T
	10	GH0	250	EMA2GM100GH0D00T
	15	WG5	300	EMA2GM150WG5D00T
	22	WM5	380	EMA2GM220WM5D00T
	100	WM5	540	EMA2GM101WM5D00T
450(2W)	2.2	GB0	70	EMA2WM2R2GB0D00T
	3.3	GB0	80	EMA2WM3R3GB0D00T
	4.7	GE0	130	EMA2WM477GE0D00T
	10	GH0	265	EMA2WM100GH0D00T
	15	WM5	310	EMA2WM150WM5D00T
	22	WM5	390	EMA2WM220WM5D00T

MH series

- Endurance: +130°C 1,000~5,000 hours
- Designed for surface mounting on high density PC board
- RoHS Compliant



SPECIFICATIONS

Items	Characteristics											
Category Temperature Range	-40~+130°C(10~450 V _{dc})											
Rated Voltage Range	10~450 V _{dc}											
Capacitance Tolerance	±20%(M) (at 20°C, 120Hz)											
Leakage Current	10~100 V _{dc}					160~450 V _{dc}						
	E80-GE0 I 0.01CV or 3μA, whichever is greater.(2 minutes)					WE0-MN0 I 0.03CV or 4μA, whichever is greater. (2 minutes)			I 0.04CV+100μA (1 minute)			
	Where, I:Max.leakage current (μA), C:Nominal capacitance (μF), V: Rated voltage (V) (at 20°C)											
Dissipation Factor (tan δ)	Rated Voltage(V _{dc})	10	16	25	35	50	63	80	100	160~250	400~450	
	tan (max.)	0.24	0.20	0.16	0.14	0.14	0.12	0.12	0.10	0.24	0.30	
	When nominal capacitance exceeds 1,000μF, add 0.02 to the value above for each 1,000μF increase. (at 20°C, 120Hz)											
Low Temperature Characteristics (Max. Impedance Ratio)	Rated Voltage(V _{dc})	10	16	25	35	50	63	80	100	160~250	400~450	
	E80-GE0	Z(-25°C)/Z(+20°C)	3	2	2	2	2	2	2	2	6	6
		Z(-40°C)/Z(+20°C)	6	4	4	3	3	3	3	3	10	18
	WE0-MN0	Z(-25°C)/Z(+20°C)	4	3	2	2	2	2	2	2	6	6
Z(-40°C)/Z(+20°C)		8	6	4	3	3	3	3	3	10	18	
Endurance	The specifications listed below shall be met when the capacitors are restored to 20°C after DC voltage is applied for a specified period of time at 130°C.											
	Load Life	E80-EB0(10~100V _{dc}): 1000 hours FB0-GH0(10~100V _{dc}): 2000 hours WE0-MN0(10~100V _{dc}): 5000 hours FB0-MN0(160~450V _{dc}): 3000 hours										
	Capacitance Change	±30% of the initial value										
	Dissipation Factor (tan δ)	300% of the initial specified value										
Shelf Life	The following specifications shall be satisfied when the capacitors are restored to 20°C after leaving them under no load at 130°C for 1,000 hours (400~450V _{dc} : 500 hours).											
	Rated Voltage(V _{dc})	10~450										
	Capacitance Change	±30% of the initial value										
	Leakage Current	500% of the initial specified value										

DIMENSIONS[mm]

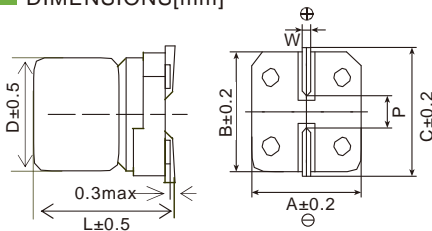

Size code	D	L	A	B	C	W	P
E80	6.3	7.7	6.6	6.6	7.2	0.5~0.8	1.9
E83	6.3	8.0	6.6	6.6	7.2	0.5~0.8	1.9
EB0	6.3	10.5	6.6	6.6	7.2	0.5~0.8	1.9
FB0	8	10.5	8.3	8.3	9.0	0.7~1.1	3.1
FD0	8	12.5	8.3	8.3	9.0	0.7~1.1	3.1
GB0	10	10.5	10.3	10.3	11.0	0.7~1.1	4.5
GD0	10	12.5	10.3	10.3	11.0	0.7~1.1	4.5
GE0	10	13.5	10.3	10.3	11.0	0.7~1.1	4.5
GH0	10	16.5	10.3	10.3	11.0	0.7~1.1	4.5
WE0	12.5	13.5	13.0	13.0	13.7	1.0~1.3	4.5
WG5	12.5	16.0	13.0	13.0	13.7	1.0~1.3	4.5
WM5	12.5	21.0	13.0	13.0	13.7	1.0~1.3	4.5
LH0	16	16.5	17.0	17.0	18.0	1.0~1.3	6.5
LN0	16	21.5	17.0	17.0	18.0	1.0~1.3	6.5
MH0	18	16.5	19.0	19.0	20.0	1.0~1.3	6.5
MN0	18	21.5	19.0	19.0	20.0	1.0~1.3	6.5

PART NUMBERING SYSTEM

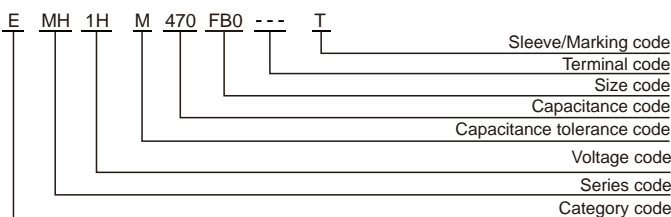

RATED RIPPLE CURRENT MULTIPLIERS

Frequency correction factor for ripple current

Rated voltage (V _{dc})	Cap.(μF)	Freq.(Hz)			
		120	1k	10k	100k
10~100	Cap.<220	0.40	0.75	0.90	1.00
	220 Cap.<680	0.50	0.85	0.94	1.00
	680 Cap.<2200	0.60	0.87	0.95	1.00
	2200 Cap.<3300	0.75	0.90	0.95	1.00
	Cap. 3300	0.85	0.95	0.98	1.00
160~450	Cap. 33	0.55	0.83	0.97	1.00
	Cap.>33	0.66	0.86	0.93	1.00

MH series

■ STANDARD RATINGS (Rated ripple current:mArms/130°C 100kHz)

WV (Vdc)	Cap (μF)	Size code	Rated ripple current	Part Number
10(1A)	100	E83	110	EMH1AM101E83D00T
	220	E83	110	EMH1AM221E83D00T
		FB0	220	EMH1AM221FB0D00T
	330	FB0	220	EMH1AM331FB0D00T
		GB0	296	EMH1AM331GB0D00T
	470	GB0	296	EMH1AM471GB0D00T
	1000	WE0	750	EMH1AM102WE0D00T
	2200	LH0	1000	EMH1AM222LH0D00T
	3300	MH0	1200	EMH1AM332MH0D00T
4700	MN0	1550	EMH1AM472MN0D00T	
16(1C)	100	E83	110	EMH1CM101E83D00T
	220	FB0	220	EMH1CM101FB0D00T
		FB0	220	EMH1CM221FB0D00T
	330	GB0	296	EMH1CM331GB0D00T
	470	GD0	340	EMH1CM471GD0D00T
	680	WE0	750	EMH1CM681WE0D00T
	1000	WG5	800	EMH1CM102WG5D00T
1500	LH0	1000	EMH1CM152LH0D00T	
25(1E)	47	E83	110	EMH1EM470E83D00T
	100	E83	110	EMH1EM101E83D00T
		FB0	220	EMH1EM101FB0D00T
	220	FB0	220	EMH1EM221FB0D00T
		GB0	296	EMH1EM221GB0D00T
	330	GB0	296	EMH1EM331GB0D00T
	470	WE0	750	EMH1EM471WE0D00T
680	WG5	800	EMH1EM681WG5D00T	
1000	LH0	1000	EMH1EM102LH0D00T	
35(1V)	33	E83	110	EMH1VM330E83D00T
	47	E83	110	EMH1VM470E83D00T
	100	FB0	220	EMH1VM101FB0D00T
	220	GB0	296	EMH1VM221GB0D00T
	330	WE0	750	EMH1VM331WE0D00T
	470	WG5	900	EMH1VM471WG5D00T
	680	LH0	1000	EMH1VM681LH0D00T
	1000	MH0	1200	EMH1VM102MH0D00T
50(1H)	10	E83	83	EMH1HM100E83D00T
	22	E83	83	EMH1HM220E83D00T
	33	E83	83	EMH1HM330E83D00T
	47	FB0	160	EMH1HM470FB0D00T
		GB0	247	EMH1HM470GB0D00T
	100	GB0	247	EMH1HM101GB0D00T
		WE0	550	EMH1HM101WE0D00T
	220	WE0	550	EMH1HM221WE0D00T
	330	WG5	700	EMH1HM331WG5D00T
	470	LH0	850	EMH1HM471LH0D00T
	560	MH0	920	EMH1HM561MH0D00T
63(1J)	22	E83	65	EMH1JM220E83D00T
	33	FB0	100	EMH1JM330FB0D00T
	47	FB0	125	EMH1JM470FB0D00T
	100	GD0	270	EMH1JM101GD0D00T
	220	WG5	600	EMH1JM221WG5D00T
	330	LH0	820	EMH1JM331LH0D00T
	470	LN0	1100	EMH1JM471LN0D00T

WV (Vdc)	Cap (μF)	Size code	Rated ripple current	Part Number
80(1B)	10	E83	95	EMH1BM100E83D00T
	22	FB0	110	EMH1BM220FB0D00T
		GB0	215	EMH1BM220GB0D00T
	33	FB0	130	EMH1BM330FB0D00T
	47	GB0	245	EMH1BM470GB0D00T
	100	WE0	475	EMH1BM101WE0D00T
100(1K)	10	E83	90	EMH1KM100E83D00T
	22	FB0	105	EMH1KM220FB0D00T
	33	GB0	200	EMH1KM330GB0D00T
	47	GB0	230	EMH1KM470GB0D00T
	68	GD0	275	EMH1KM680GD0D00T
	100	WE0	405	EMH1KM101WE0D00T
160(2C)	220	LH0	650	EMH1KM221LH0D00T
	10	GB0	72	EMH2CM100GB0D00T
	15	FD0	90	EMH2CM150FD0D00T
	22	GD0	150	EMH2CM220GD0D00T
	33	GE0	165	EMH2CM330GE0D00T
	47	GH0	195	EMH2CM470GH0D00T
200(2D)	68	WM5	234	EMH2CM680WM5D00T
	100	WM5	300	EMH2CM101WM5D00T
	10	FE0	90	EMH2DM100FE0D00T
	15	GB0	90	EMH2DM100GB0D00T
		GD0	115	EMH2DM150GD0D00T
	22	GH0	180	EMH2DM220GH0D00T
33	WG5	200	EMH2DM330WG5D00T	
47	WM5	240	EMH2DM470WM5D00T	
250(2E)	4.7	GB0	59	EMH2EM470GB0D00T
	10	FE0	94	EMH2EM100FE0D00T
		GB0	94	EMH2EM100GB0D00T
	22	GH0	190	EMH2EM220GH0D00T
	33	WM5	210	EMH2EM330WM5D00T
	47	WM5	256	EMH2EM470WM5D00T
400(2G)	2.2	FB0	30	EMH2GM2R2FB0D00T
	3.3	FB0	40	EMH2GM3R3FB0D00T
	4.7	FE0	65	EMH2GM4R7FE0D00T
		GB0	65	EMH2GM4R7GB0D00T
	5.6	FE0	80	EMH2GM5R6FE0D00T
	6.8	GE0	90	EMH2GM6R8GE0D00T
	10	GH0	102	EMH2GM100GH0D00T
15	WG5	130	EMH2GM150WG5D00T	
22	WM5	204	EMH2GM220WM5D00T	
450(2W)	2.2	GB0	32	EMH2WM2R2GB0D00T
	3.3	GD0	36	EMH2WM3R3GD0D00T
	4.7	GE0	48	EMH2WM4R7GE0D00T
	10	WG5	89	EMH2WM100WG5D00T
	15	WM5	115	EMH2WM150WM5D00T

M5 series

- Low profile with 5mm height
- Endurance: +85°C 1,000 hours
- RoHS Compliant



SPECIFICATIONS

Items	Characteristics	
Category Temperature Range	-40~+85°C	
Rated Voltage Range	4~50 V _{dc}	
Capacitance Tolerance	±20%(M) (at 20°C, 120Hz)	
Leakage Current	I 0.01CV or 3μA, whichever is greater. Where, I:Max.leakage current (μA),C:Nominal capacitance (μF),V: Rated voltage (V) (at 20°C after 2 minutes)	
Dissipation Factor (tan δ)	Rated Voltage(V _{dc})	4 6.3 10 16 25 35 50
	tan δ (max.)	4- 6.3 0.35 0.26 0.22 0.18 0.16 0.14 0.12 8 0.39 0.28 0.24 0.18 0.16 0.14 0.12 (at 20°C, 120Hz)
Low Temperature Characteristics (Max. Impedance Ratio)	Rated Voltage(V _{dc})	4 6.3 10 16 25 35 50
	Z(-25°C)/Z(+20°C)	6 4 3 2
	Z(-40°C)/Z(+20°C)	16 10 8 6 4 (at 120Hz)
Endurance	The following specifications shall be satisfied when the capacitors are restored to 20°C after the rated voltage is applied for 1,000 hours at 85°C.	
	Capacitance Change	±25% of the initial value
	D.F. (tan δ)	200% of the initial specified value
	Leakage Current	The initial specified value
Shelf Life	The following specifications shall be satisfied when the capacitors are restored to 20°C after exposing them for 500 hours at 85°C without voltage applied.	
	Capacitance Change	±20% of the initial value
	D.F. (tan δ)	200% of the initial specified value
	Leakage Current	200% of the initial specified value

DIMENSIONS[mm]

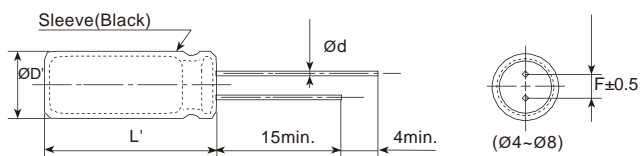

ØD	4	5	6.3	8
Ød	0.45	0.45	0.45	0.45
F	1.5	2.0	2.5	3.5
ØD'	ØD+0.5max.			
L'	L+1.5max.			

PART NUMBERING SYSTEM

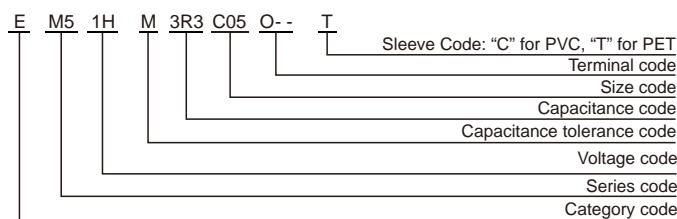

RATED RIPPLE CURRENT MULTIPLIERS

Frequency correction factor for ripple current

WV(V _{dc})	Freq.(Hz)			
	50/60	120	1k	10k-100k
4 to 16	0.80	1.00	1.10	1.20
25 to 35	0.80	1.00	1.50	1.70
50	0.80	1.00	1.60	1.90

The endurance of capacitors is shortened with internal heating produced by ripple current at the rate of halving the lifetime with every 5 °C rise. When long life performance is required in actual use, the rms ripple current has to be reduced.

M5 series

■ STANDARD RATINGS

WV (V _{dc})	Cap (μF)	Size DxL(mm)	tan	Rated ripple current (mA _{rms} /85°C,120Hz)	Part Number
4(0G)	22	4x5	0.35	25	EM50GM220C05OT
	33	4x5	0.35	30	EM50GM330C05OT
	47	4x5	0.35	35	EM50GM470C05OT
	100	5x5	0.35	60	EM50GM101D05OT
	220	6.3x5	0.35	105	EM50GM221E05OT
	330	8x5	0.39	150	EM50GM331F05OT
	470	8x5	0.39	180	EM50GM471F05OT
6.3(0J)	10	4x5	0.26	20	EM50JM100C05OT
	22	4x5	0.26	30	EM50JM220C05OT
	33	5x5	0.26	40	EM50JM330D05OT
	47	5x5	0.26	50	EM50JM470D05OT
	100	6.3x5	0.26	85	EM50JM101E05OT
	220	8x5	0.28	145	EM50JM221F05OT
	330	8x5	0.28	175	EM50JM331F05OT
10(1A)	10	4x5	0.22	22	EM51AM100C05OT
	22	5x5	0.22	35	EM51AM220D05OT
	33	5x5	0.22	45	EM51AM330D05OT
	47	6.3x5	0.22	65	EM51AM470E05OT
	100	6.3x5	0.22	95	EM51AM101E05OT
	220	8x5	0.24	155	EM51AM221F05OT
	16(1C)	4.7	4x5	0.18	17
10		4x5	0.18	25	EM51CM100C05OT
22		5x5	0.18	40	EM51CM220D05OT
33		6.3x5	0.18	60	EM51CM330E05OT
47		6.3x5	0.18	70	EM51CM470E05OT
100		8x5	0.18	125	EM51CM101F05OT
25(1E)		3.3	4x5	0.16	15
	4.7	4x5	0.16	18	EM51EM4R7C05OT
	10	5x5	0.16	30	EM51EM100D05OT
	22	6.3x5	0.16	50	EM51EM220E05OT
	33	6.3x5	0.16	65	EM51EM330E05OT
	47	8x5	0.16	95	EM51EM470F05OT
	100	8x5	0.16	135	EM51EM101F05OT
35(1V)	2.2	4x5	0.14	8.4	EM51VM2R2C05OT
	3.3	4x5	0.14	17	EM51VM3R3C05OT
	4.7	5x5	0.14	20	EM51VM4R7D05OT
	10	5x5	0.14	30	EM51VM100D05OT
	22	6.3x5	0.14	50	EM51VM220E05OT
	33	8x5	0.14	80	EM51VM330F05OT
	47	8x5	0.14	100	EM51VM470F05OT
50(1H)	0.1	4x5	0.12	1	EM51HMR10C05OT
	0.22	4x5	0.12	2	EM51HMR22C05OT
	0.33	4x5	0.12	2.8	EM51HMR33C05OT
	0.47	4x5	0.12	4	EM51HMR47C05OT
	1	4x5	0.12	8.4	EM51HM010C05OT
	2.2	4x5	0.12	13	EM51HM2R2C05OT
	3.3	4x5	0.12	18	EM51HM3R3C05OT
	4.7	5x5	0.12	25	EM51HM4R7D05OT
	10	6.3x5	0.12	40	EM51HM100E05OT
	22	8x5	0.12	75	EM51HM220F05OT
	33	8x5	0.12	90	EM51HM330F05OT

H5 series

- Low profile with 5mm height
- Wide temperature range of -40 °C to +105°C
- Endurance +105°C 1,000 hours
- RoHS Compliant



SPECIFICATIONS

Items	Characteristics							
Category Temperature Range	-40~+105°C							
Rated Voltage Range	6.3~50 V _{dc}							
Capacitance Tolerance	±20%(M) (at 20°C, 120Hz)							
Leakage Current	I ≤ 0.01CV or 3μA, whichever is greater. Where, I: Max.leakage current (μA), C: Nominal capacitance (μF), V: Rated voltage (V) (at 20°C after 2 minutes)							
Dissipation Factor (tan δ)	Rated Voltage(V _{dc})	6.3	10	16	25	35	50	(at 20°C, 120Hz)
	tan δ (max.)	0.28	0.24	0.20	0.14	0.12	0.10	
Low Temperature Characteristics (Max. Impedance Ratio)	Rated Voltage(V _{dc})	6.3	10	16	25	35	50	(at 120Hz)
	Z(-25°C)/Z(+20°C)	3		2				
	Z(-40°C)/Z(+20°C)	8	5	4	3			
Endurance	The following specifications shall be satisfied when the capacitors are restored to 20°C after the rated voltage is applied for 1,000 hours at 105°C.							
	Capacitance Change	±20% of the initial value						
	D.F. (tan δ)	200% of the initial specified value						
	Leakage Current	The initial specified value						
Shelf Life	The following specifications shall be satisfied when the capacitors are restored to 20°C after exposing them for 500 hours at 105°C without voltage applied.							
	Capacitance Change	±20% of the initial value						
	D.F. (tan δ)	200% of the initial specified value						
	Leakage Current	200% of the initial specified value						

DIMENSIONS[mm]

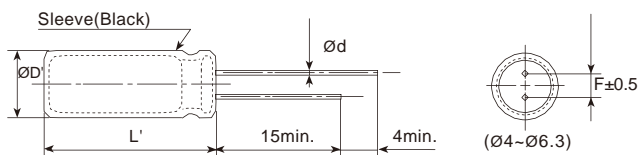

øD	4	5	6.3
ød	0.45	0.45	0.45
F	1.5	2.0	2.5
øD'	øD+0.5max.		
L'	L+1.5max.		

PART NUMBERING SYSTEM

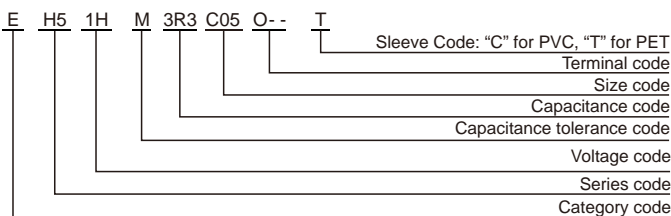

RATED RIPPLE CURRENT MULTIPLIERS

Frequency correction factor for ripple current

WV(V _{dc})	Freq.(Hz)	50/60	120	1k	10k-100k
	6.3 to 16		0.80	1.00	1.30
25 to 35		0.80	1.00	1.20	1.20
50		0.80	1.00	1.15	1.20

The endurance of capacitors is shortened with internal heating produced by ripple current at the rate of halving the lifetime with every 5 °C rise. When long life performance is required in actual use, the rms ripple current has to be reduced.

H5 series

■ STANDARD RATINGS

WV (V _{dc})	Cap (μF)	Size DxL(mm)	tan	Rated ripple current (mA _{rms} /105°C,120Hz)	Part Number
6.3(0J)	22	4x5	0.28	23	EH50JM220C05OT
	33	5x5	0.28	30	EH50JM330D05OT
	47	5x5	0.28	37	EH50JM470D05OT
	100	6.3x5	0.28	57	EH50JM101E05OT
10(1A)	10	4x5	0.24	20	EH51AM100C05OT
	22	5x5	0.24	28	EH51AM220D05OT
	33	5x5	0.24	34	EH51AM330D05OT
	47	6.3x5	0.24	52	EH51AM470E05OT
16(1C)	4.7	4x5	0.20	15	EH51CM4R7C05OT
	10	4x5	0.20	23	EH51CM100C05OT
	22	5x5	0.20	31	EH51CM220D05OT
	33	6.3x5	0.20	48	EH51CM330E05OT
25(1E)	4.7	4x5	0.14	15	EH51EM4R7C05OT
	10	5x5	0.14	22	EH51EM100D05OT
	22	6.3x5	0.14	44	EH51EM220E05OT
	33	6.3x5	0.14	48	EH51EM330E05OT
35(1V)	3.3	4x5	0.12	13	EH51VM3R3C05OT
	4.7	4x5	0.12	17	EH51VM4R7C05OT
	10	5x5	0.12	24	EH51VM100D05OT
	22	6.3x5	0.12	48	EH51VM220E05OT
50(1H)	0.1	4x5	0.10	1	EH51HMR10C05OT
	0.22	4x5	0.10	2	EH51HMR22C05OT
	0.33	4x5	0.10	3	EH51HMR33C05OT
	0.47	4x5	0.10	4	EH51HMR47C05OT
	1	4x5	0.10	8	EH51HM010C05OT
	2.2	4x5	0.10	13	EH51HM2R2C05OT
	3.3	4x5	0.10	14	EH51HM3R3C05OT
	4.7	5x5	0.10	18	EH51HM4R7D05OT
10	6.3x5	0.10	28	EH51HM100E05OT	

M7 series

- Standard miniature series with 7mm height
- Endurance: +85°C 1,000 hours
- RoHS Compliant



SPECIFICATIONS

Items	Characteristics										
Category Temperature Range	-40~+85°C										
Rated Voltage Range	4~100 V _{dc}										
Capacitance Tolerance	±20%(M) (at 20°C, 120Hz)										
Leakage Current	I 0.01CV or 3μA, whichever is greater. Where, I:Max.leakage current (μA),C:Nominal capacitance (μF),V: Rated voltage (V) (at 20°C after 2 minutes)										
Dissipation Factor (tan δ)	Rated Voltage(V _{dc})	4	6.3	10	16	25	35	50	63	100	(at 20°C, 120Hz)
	tan δ (max.)	0.35	0.24	0.20	0.16	0.14	0.12	0.10	0.08	0.08	
Low Temperature Characteristics (Max. Impedance Ratio)	Rated Voltage(V _{dc})	4	6.3	10	16	25	35	50	63	100	(at 120Hz)
	Z(-25°C)/Z(+20°C)	6	4	3	2						
	Z(-40°C)/Z(+20°C)	16	10	8	6	4					
Endurance	The following specifications shall be satisfied when the capacitors are restored to 20°C after the rated voltage is applied for 1,000 hours at 85°C.										
	Capacitance Change	±20% of the initial value									
	D.F. (tan δ)	200% of the initial specified value									
	Leakage Current	The initial specified value									
Shelf Life	The following specifications shall be satisfied when the capacitors are restored to 20°C after exposing them for 500 hours at 85°C without voltage applied.										
	Capacitance Change	±20% of the initial value									
	D.F. (tan δ)	200% of the initial specified value									
	Leakage Current	200% of the initial specified value									

DIMENSIONS[mm]

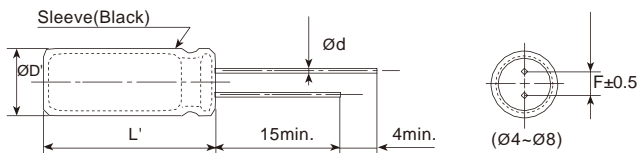

øD	4	5	6.3	8
ød	0.45	0.45	0.5	0.5
F	1.5	2.0	2.5	3.5
øD'	øD+0.5max.			
L'	L+1.5max.			

PART NUMBERING SYSTEM

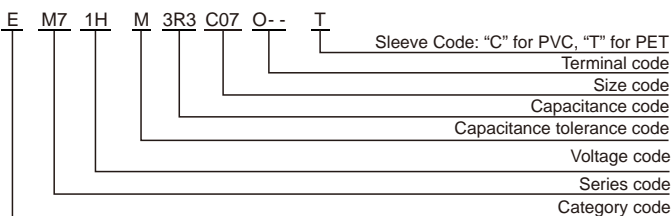

RATED RIPPLE CURRENT MULTIPLIERS

Frequency correction factor for ripple current

WV(V _{dc}) \ Freq.(Hz)	50/60	120	1k	10k-100k
4 to 16	0.80	1.00	1.10	1.20
25 to 35	0.80	1.00	1.50	1.70
50	0.80	1.00	1.60	1.90

The endurance of capacitors is shortened with internal heating produced by ripple current at the rate of halving the lifetime with every 5 °C rise. When long life performance is required in actual use, the rms ripple current has to be reduced.

M7 series

■ STANDARD RATINGS

WV (V _{dc})	Cap (μF)	Size D×L(mm)	tan	Rated ripple current (mArms/85°C,120Hz)	Part Number
4(0G)	33	4×7	0.35	35	EM70GM330C07OT
	47	4×7	0.35	40	EM70GM470C07OT
	100	5×7	0.35	70	EM70GM101D07OT
	220	6.3×7	0.35	120	EM70GM221E07OT
	330	8×7	0.35	170	EM70GM331F07OT
6.3(0J)	22	4×7	0.24	35	EM70JM220C07OT
	33	4×7	0.24	40	EM70JM330C07OT
	47	4×7	0.24	50	EM70JM470C07OT
	100	5×7	0.24	80	EM70JM101D07OT
	220	6.3×7	0.24	140	EM70JM221E07OT
	330	8×7	0.24	205	EM70JM331F07OT
10(1A)	22	4×7	0.20	35	EM71AM220C07OT
	33	4×7	0.20	45	EM71AM330C07OT
	47	5×7	0.20	60	EM71AM470D07OT
	100	6.3×7	0.20	108	EM71AM101E07OT
	220	8×7	0.20	185	EM71AM221F07OT
16(1C)	10	4×7	0.16	35	EM71CM100C07OT
	22	4×7	0.16	40	EM71CM220C07OT
	33	5×7	0.16	55	EM71CM330D07OT
	47	5×7	0.16	70	EM71CM470D07OT
	100	6.3×7	0.16	120	EM71CM101E07OT
	220	8×7	0.16	205	EM71CM221F07OT
25(1E)	3.3	4×7	0.14	15	EM71EM3R3C07OT
	4.7	4×7	0.14	20	EM71EM4R7C07OT
	10	4×7	0.14	30	EM71EM100C07OT
	22	5×7	0.14	50	EM71EM220D07OT
	33	6.3×7	0.14	70	EM71EM330E07OT
	47	6.3×7	0.14	85	EM71EM470E07OT
	100	8×7	0.14	145	EM71EM101F07OT
35(1V)	3.3	4×7	0.12	15	EM71VM3R3C07OT
	4.7	4×7	0.12	20	EM71VM4R7C07OT
	10	4×7	0.12	30	EM71VM100C07OT
	22	5×7	0.12	55	EM71VM220D07OT
	33	6.3×7	0.12	75	EM71VM330E07OT
	47	8×7	0.12	110	EM71VM470F07OT
50(1H)	0.1	4×7	0.10	4	EM71HMR10C07OT
	0.22	4×7	0.10	5	EM71HMR22C07OT
	0.33	4×7	0.10	7	EM71HMR33C07OT
	0.47	4×7	0.10	8	EM71HMR47C07OT
	1	4×7	0.10	10	EM71HM010C07OT
	2.2	4×7	0.10	15	EM71HM2R2C07OT
	3.3	4×7	0.10	20	EM71HM3R3C07OT
	4.7	4×7	0.10	24	EM71HM4R7C07OT
	10	5×7	0.10	40	EM71HM100D07OT
	22	6.3×7	0.10	70	EM71HM220E07OT
33	8×7	0.10	100	EM71HM330F07OT	
63(1J)	0.1	4×7	0.08	4	EM71JMR10C07OT
	0.22	4×7	0.08	6	EM71JMR22C07OT
	0.33	4×7	0.08	7	EM71JMR33C07OT
	0.47	4×7	0.08	8	EM71JMR47C07OT
	1	4×7	0.08	10	EM71JM010C07OT
	2.2	4×7	0.08	15	EM71JM2R2C07OT
	3.3	4×7	0.08	23	EM71JM3R3C07OT
	4.7	5×7	0.08	30	EM71JM4R7D07OT
	10	6.3×7	0.08	50	EM71JM100E07OT
100(1K)	1	4×7	0.08	12	EM71KM010C07OT
	2.2	5×7	0.08	20	EM71KM2R2D07OT
	3.3	6.3×7	0.08	30	EM71KM3R3E07OT
	4.7	6.3×7	0.08	35	EM71KM4R7E07OT

H7 series

- Miniature series with 7mm height
- Endurance: +105°C 1,000 hours
- Wide temperature range of -40 °C to +105°C
- RoHS Compliant



SPECIFICATIONS

Items	Characteristics						
Category Temperature Range	-40~+105°C						
Rated Voltage Range	6.3~50 V _{dc}						
Capacitance Tolerance	±20%(M) (at 20°C, 120Hz)						
Leakage Current	I 0.01CV or 3μA, whichever is greater. Where, I:Max.leakage current (μA),C:Nominal capacitance (μF),V: Rated voltage (V) (at 20°C after 2 minutes)						
Dissipation Factor (tan δ)	Rated Voltage(V _{dc})	6.3	10	16	25	35	50
	tan (max.)	0.22	0.19	0.16	0.14	0.12	0.10
Low Temperature Characteristics (Max. Impedance Ratio)	Rated Voltage(V _{dc})	6.3	10	16	25	35	50
	Z(-25°C)/Z(+20°C)	3		2			
	Z(-40°C)/Z(+20°C)	8	5	4	3		
Endurance	The following specifications shall be satisfied when the capacitors are restored to 20°C after the rated voltage is applied for 1,000 hours at 105°C.						
	Capacitance Change	±20% of the initial value					
	D.F. (tan δ)	200% of the initial specified value					
	Leakage Current	The initial specified value					
Shelf Life	The following specifications shall be satisfied when the capacitors are restored to 20°C after exposing them for 500 hours at 105°C without voltage applied.						
	Capacitance Change	±20% of the initial value					
	D.F. (tan δ)	200% of the initial specified value					
	Leakage Current	200% of the initial specified value					

DIMENSIONS[mm]

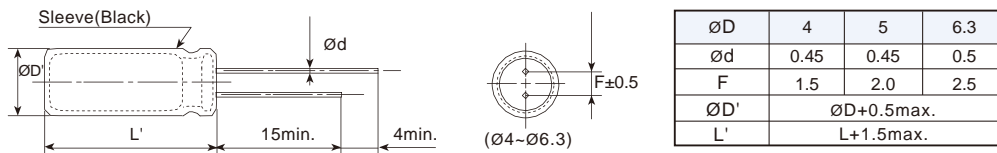

PART NUMBERING SYSTEM

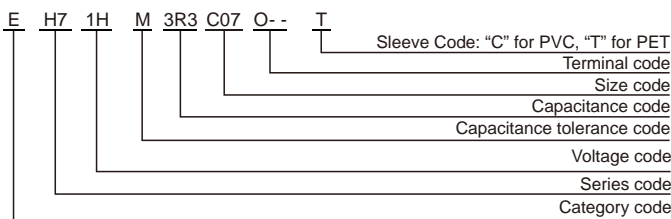

RATED RIPPLE CURRENT MULTIPLIERS

Frequency correction factor for ripple current

WV(V _{dc})	Freq.(Hz)			
	50/60	120	1k	10k-100k
6.3 to 16	0.94	1.00	1.28	1.39
25 to 35	0.76	1.00	1.27	1.59
50	0.90	1.00	1.40	2.00

The endurance of capacitors is shortened with internal heating produced by ripple current at the rate of halving the lifetime with every 5 °C rise. When long life performance is required in actual use, the rms ripple current has to be reduced.

H7 series

■ STANDARD RATINGS

WV (V _{dc})	Cap (μF)	Size DxL(mm)	tan	Rated ripple current (mA _{rms} /105°C,120Hz)	Part Number
6.3(0J)	22	4x7	0.22	34	EH70JM220C07OT
	33	5x7	0.22	42	EH70JM330D07OT
	47	5x7	0.22	50	EH70JM470D07OT
	100	6.3x7	0.22	77	EH70JM101E07OT
10(1A)	22	5x7	0.19	38	EH71AM220D07OT
	33	5x7	0.19	47	EH71AM330D07OT
	47	6.3x7	0.19	65	EH71AM470E07OT
	100	6.3x7	0.19	87	EH71AM101E07OT
16(1C)	10	4x7	0.16	29	EH71CM100C07OT
	22	5x7	0.16	44	EH71CM220D07OT
	33	6.3x7	0.16	60	EH71CM330E07OT
	47	6.3x7	0.16	70	EH71CM470E07OT
25(1E)	3.3	4x7	0.14	21	EH71EM3R3C07OT
	4.7	4x7	0.14	25	EH71EM4R7C07OT
	10	5x7	0.14	33	EH71EM100D07OT
	22	6.3x7	0.14	51	EH71EM220E07OT
	33	6.3x7	0.14	65	EH71EM330E07OT
35(1V)	3.3	4x7	0.12	23	EH71VM3R3C07OT
	4.7	4x7	0.12	25	EH71VM4R7C07OT
	10	5x7	0.12	36	EH71VM100D07OT
	22	6.3x7	0.12	60	EH71VM220E07OT
50(1H)	0.1	4x7	0.10	1.0	EH71HMR10C07OT
	0.22	4x7	0.10	2.3	EH71HMR22C07OT
	0.33	4x7	0.10	3.5	EH71HMR33C07OT
	0.47	4x7	0.10	5	EH71HMR47C07OT
	1	4x7	0.10	10	EH71HM010C07OT
	2.2	4x7	0.10	19	EH71HM2R2C07OT
	3.3	4x7	0.10	24	EH71HM3R3C07OT
	4.7	5x7	0.10	29	EH71HM4R7D07OT
	10	6.3x7	0.10	44	EH71HM100E07OT
	22	6.3x7	0.10	60	EH71HM220E07OT

L7 series

- Miniature series with 7mm height
- Endurance : +105 °C 2,000 hours
- Wide temperature range of -40°C to +105°C
- RoHS Compliant



SPECIFICATIONS

Items	Characteristics								
Category Temperature Range	-40~+105°C								
Rated Voltage Range	6.3~63 V _{dc}								
Capacitance Tolerance	±20%(M) (at 20°C, 120Hz)								
Leakage Current	I 0.01CV or 3μA, whichever is greater. Where, I:Max.leakage current (μA),C:Nominal capacitance (μF),V: Rated voltage (V) (at 20°C after 2 minutes)								
Dissipation Factor (tan δ)	Rated Voltage(V _{dc})	6.3	10	16	25	35	50	63	(at 20°C, 120Hz)
	tan δ (max.)	0.22	0.19	0.16	0.14	0.12	0.10	0.09	
Low Temperature Characteristics (Max. Impedance Ratio)	Rated Voltage(V _{dc})	6.3	10	16	25	35	50	63	(at 120Hz)
	Z(-25°C)/Z(+20°C)	4	3	2					
	Z(-40°C)/Z(+20°C)	8	6	4	3				
Endurance	The following specifications shall be satisfied when the capacitors are restored to 20°C after the rated voltage is applied for 2,000 hours at 105°C.								
	Capacitance Change	±20% of the initial value							
	D.F. (tan δ)	200% of the initial specified value							
	Leakage Current	The initial specified value							
Shelf Life	The following specifications shall be satisfied when the capacitors are restored to 20°C after exposing them for 1,000 hours at 105°C without voltage applied.								
	Capacitance Change	±20% of the initial value							
	D.F. (tan δ)	200% of the initial specified value							
	Leakage Current	200% of the initial specified value							

DIMENSIONS[mm]

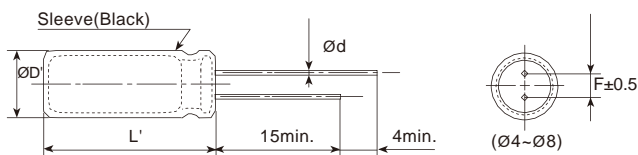

øD	4	5	6.3	8
ød	0.45	0.45	0.5	0.5
F	1.5	2.0	2.5	3.5
øD'	øD+0.5max.			
L'	L+2max.			

PART NUMBERING SYSTEM

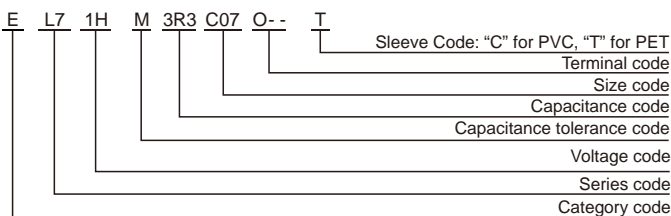

RATED RIPPLE CURRENT MULTIPLIERS

Frequency correction factor for ripple current

WV(V _{dc})	Freq.(Hz)			
	50/60	120	1k	10k-100k
6.3 to 16	0.80	1.00	1.30	1.50
25 to 35	0.80	1.00	1.20	1.20
50	0.80	1.00	1.15	1.20

The endurance of capacitors is shortened with internal heating produced by ripple current at the rate of halving the lifetime with every 5 °C rise. When long life performance is required in actual use, the rms ripple current has to be reduced.

L7 series

■ STANDARD RATINGS

WV (V _{dc})	Cap (μF)	Size DxL(mm)	tan	Rated ripple current (mA _{rms} /105°C, 120Hz)	Part Number
6.3(0J)	22	4x7	0.22	28	EL70JM220C07OT
	33	4x7	0.22	32	EL70JM330C07OT
		5x7	0.22	35	EL70JM330D07OT
	47	5x7	0.22	47	EL70JM470D07OT
	68	5x7	0.22	50	EL70JM680D07OT
	100	6.3x7	0.22	75	EL70JM101E07OT
	220	8x7	0.22	92	EL70JM221F07OT
10(1A)	22	4x7	0.19	32	EL71AM220C07OT
	33	5x7	0.19	48	EL71AM330D07OT
	47	5x7	0.19	51	EL71AM470D07OT
	68	6.3x7	0.19	68	EL71AM680E07OT
	100	6.3x7	0.19	80	EL71AM101E07OT
		8x7	0.19	95	EL71AM101F07OT
220	8x7	0.19	130	EL71AM221F07OT	
16(1C)	10	4x7	0.16	28	EL71CM100C07OT
	22	4x7	0.16	35	EL71CM220C07OT
		5x7	0.16	42	EL71CM220D07OT
	33	5x7	0.16	50	EL71CM330D07OT
	47	6.3x7	0.16	67	EL71CM470E07OT
	68	6.3x7	0.16	70	EL71CM680E07OT
		8x7	0.16	78	EL71CM680F07OT
	100	8x7	0.16	110	EL71CM101F07OT
25(1E)	4.7	4x7	0.14	17	EL71EM4R7C07OT
	6.8	4x7	0.14	19	EL71EM6R8C07OT
	10	4x7	0.14	28	EL71EM100C07OT
		5x7	0.14	33	EL71EM100D07OT
	22	5x7	0.14	43	EL71EM220D07OT
		6.3x7	0.14	45	EL71EM220E07OT
	33	6.3x7	0.14	62	EL71EM330E07OT
	47	8x7	0.14	75	EL71EM470F07OT
	68	8x7	0.14	80	EL71EM680F07OT
	100	8x7	0.14	115	EL71EM101F07OT

WV (V _{dc})	Cap (μF)	Size DxL(mm)	tan	Rated ripple current (mA _{rms} /105°C, 120Hz)	Part Number
35(1V)	4.7	4x7	0.12	22	EL71VM4R7C07OT
	6.8	4x7	0.12	24	EL71VM6R8C07OT
		5x7	0.12	28	EL71VM6R8D07OT
	10	5x7	0.12	35	EL71VM100D07OT
	22	6.3x7	0.12	60	EL71VM220E07OT
	33	6.3x7	0.12	50	EL71VM330E07OT
		8x7	0.12	68	EL71VM330F07OT
	47	8x7	0.12	80	EL71VM470F07OT
68	8x7	0.12	85	EL71VM680F07OT	
50(1H)	0.1	4x7	0.10	1.5	EL71HMR10C07OT
	0.22	4x7	0.10	2.5	EL71HMR22C07OT
	0.33	4x7	0.10	3.5	EL71HMR33C07OT
	0.47	4x7	0.10	5	EL71HMR47C07OT
	0.68	4x7	0.10	7	EL71HMR68C07OT
	1	4x7	0.10	10	EL71HM010C07OT
	2.2	4x7	0.10	20	EL71HM2R2C07OT
	3.3	4x7	0.10	26	EL71HM3R3C07OT
	4.7	4x7	0.10	27	EL71HM4R7C07OT
		5x7	0.10	29	EL71HM4R7D07OT
10	6.3x7	0.10	38	EL71HM100E07OT	
22	8x7	0.10	63	EL71HM220F07OT	
33	8x7	0.10	78	EL71HM330F07OT	
63(1J)	0.1	4x7	0.09	1.5	EL71JMR10C07OT
	0.22	4x7	0.09	2.5	EL71JMR22C07OT
	0.33	4x7	0.09	3.5	EL71JMR33C07OT
	0.47	4x7	0.09	6	EL71JMR47C07OT
	1	4x7	0.09	12	EL71JM010C07OT
	2.2	4x7	0.09	20	EL71JM2R2C07OT
	3.3	5x7	0.09	28	EL71JM3R3D07OT
	4.7	6.3x7	0.09	33	EL71JM4R7E07OT
	10	6.3x7	0.09	40	EL71JM100E07OT
	22	8x7	0.09	65	EL71JM220F07OT

WK series

- Standard series for general purpose
- Endurance : +85 °C 2,000 hours
- RoHS Compliant



SPECIFICATIONS

Items	Characteristics														
Category Temperature Range	-40~+85°C(6.3 to 100 V _{dc})							-25~+85°C(160 to 450 V _{dc})							
Rated Voltage Range	6.3~450 V _{dc}														
Capacitance Tolerance	±20%(M) (at 20°C,120Hz)														
Leakage Current	6.3~100 V _{dc} I 0.01CV or 3μA, whichever is greater.			160~450 V _{dc} I 0.03CV+10μA			Where, I: Max.leakage current (μA),C:Nominal capacitance (μF), V: Rated voltage (V) (at 20°C after 2 minutes)								
Dissipation Factor (tan)	Rated Voltage(V _{dc})	6.3	10	16	25	35	50	63	100	160	200	250	350	400	450
	tan (max.)	0.24	0.20	0.16	0.14	0.12	0.10	0.09	0.08	0.20	0.20	0.20	0.24	0.24	0.24
When nominal capacitance exceeds 1,000μF , add 0.02 to the value above for each 1,000μF increase. (at 20°C,120Hz)															
Low Temperature Characteristics (Max. Impedance Ratio)	Rated Voltage(V _{dc})	6.3	10	16	25	35	50	63	100	160	200	250	350	400	450
	Z(-25°C)/Z(+20°C)	5	4	3	2			3			6				
	Z(-40°C)/Z(+20°C)	12	10	8	5	4	3			-			-		
(at 120Hz)															
Endurance	The following specifications shall be satisfied when the capacitors are restored to 20°C after DC voltage plus the rated ripple current is applied for 2,000 hours at 85°C.														
	Capacitance Change	±20% of the initial value													
	D.F. (tan)	200% of the initial specified value													
	Leakage Current	The initial specified value													
Shelf Life	The following specifications shall be satisfied when the capacitors are restored to 20°C after exposing them for 1,000 hours at 85°C without voltage applied.														
	Capacitance Change	±20% of the initial value													
	D.F. (tan)	200% of the initial specified value													
	Leakage Current	200% of the initial specified value													

DIMENSIONS[mm]

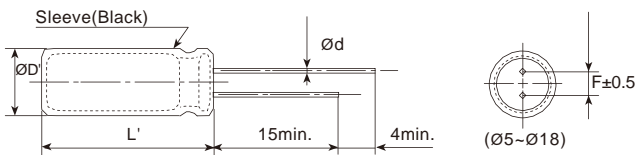

ØD	5	6.3	8	10	12.5	16	18
Ød	0.5	0.5	0.5	0.6	0.6	0.8	0.8
F	2.0	2.5	3.5	5.0	5.0	7.5	7.5
ØD'	ØD+0.5max.						
L'	L+2max.						

PART NUMBERING SYSTEM

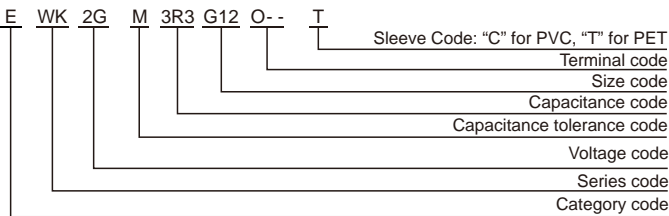

RATED RIPPLE CURRENT MULTIPLIERS

Frequency correction factor for ripple current

Freq.(Hz)	50	120	300	1k	10k	100k
Cap.<10	0.65	1.00	1.35	1.75	2.30	2.50
10 Cap.<100	0.75	1.00	1.25	1.50	1.75	1.80
100 Cap. 1000	0.80	1.00	1.15	1.30	1.40	1.50
Cap.>1000	0.85	1.00	1.03	1.05	1.08	1.08

The endurance of capacitors is shortened with internal heating produced by ripple current at the rate of halving the lifetime with every 5 °C rise. When long life performance is required in actual use, the rms ripple current has to be reduced.

WK series

■ STANDARD RATINGS

WV (Vdc)	Cap (μF)	Size DxL(mm)	tan	Rated ripple current (mA _{rms} /85°C, 120Hz)	Part Number
6.3(0J)	33	5x11	0.24	65	EWK0JM330D11OT
	47	5x11	0.24	80	EWK0JM470D11OT
	100	5x11	0.24	135	EWK0JM101D11OT
	220	5x12	0.24	220	EWK0JM221D12OT
	330	6.3x11	0.24	280	EWK0JM331E11OT
	470	6.3x12	0.24	360	EWK0JM471E12OT
	1000	8x12	0.24	590	EWK0JM102F12OT
	2200	10x20	0.26	1000	EWK0JM222G20OT
	3300	10x25	0.28	1200	EWK0JM332G25OT
	4700	12.5x20	0.30	1550	EWK0JM472W20OT
	6800	12.5x25	0.34	1920	EWK0JM682W25OT
	10000	16x25	0.42	2370	EWK0JM103L25OT
	15000	16x35	0.52	2880	EWK0JM153L35OT
	22000	18x40	0.66	3350	EWK0JM223M40OT
10(1A)	22	5x11	0.20	60	EWK1AM220D11OT
	33	5x11	0.20	75	EWK1AM330D11OT
	47	5x11	0.20	95	EWK1AM470D11OT
	100	5x11	0.20	140	EWK1AM101D11OT
	220	5x12	0.20	240	EWK1AM221D12OT
	330	6.3x11	0.20	310	EWK1AM331E11OT
	470	6.3x12	0.20	400	EWK1AM471E12OT
	1000	10x12.5	0.20	660	EWK1AM102G1BOT
	2200	10x20	0.22	1090	EWK1AM222G20OT
	3300	12.5x20	0.24	1450	EWK1AM332W20OT
	4700	12.5x25	0.26	1800	EWK1AM472W25OT
	6800	16x25	0.30	2250	EWK1AM682L25OT
	10000	16x35	0.38	2710	EWK1AM103L35OT
	15000	18x35	0.48	3120	EWK1AM153M35OT
16(1C)	10	5x11	0.16	50	EWK1CM100D11OT
	22	5x11	0.16	65	EWK1CM220D11OT
	33	5x11	0.16	80	EWK1CM330D11OT
	47	5x11	0.16	115	EWK1CM470D11OT
	100	5x11	0.16	175	EWK1CM101D11OT
	220	6.3x11	0.16	280	EWK1CM221E11OT
	330	8x11	0.16	380	EWK1CM331F11OT
	470	8x11	0.16	460	EWK1CM471F11OT
	1000	10x16	0.16	800	EWK1CM102G16OT
	2200	12.5x20	0.18	1320	EWK1CM222W20OT
	3300	12.5x25	0.20	1670	EWK1CM332W25OT
	4700	16x25	0.22	2120	EWK1CM472L25OT
	6800	16x30	0.26	2550	EWK1CM682L30OT
	25(1E)	4.7	5x11	0.14	30
10		5x11	0.14	45	EWK1EM100D11OT
22		5x11	0.14	70	EWK1EM220D11OT
33		5x11	0.14	98	EWK1EM330D11OT
47		5x11	0.14	120	EWK1EM470D11OT
100		6.3x11	0.14	190	EWK1EM101E11OT
220		8x11	0.14	330	EWK1EM221F11OT
330		8x12	0.14	440	EWK1EM331F12OT
470		10x12.5	0.14	550	EWK1EM471G1BOT
1000		10x20	0.14	970	EWK1EM102G20OT
2200		12.5x25	0.16	1570	EWK1EM222W25OT
3300		16x25	0.18	2000	EWK1EM332L25OT
4700		16x30	0.20	2450	EWK1EM472L30OT

WV (Vdc)	Cap (μF)	Size DxL(mm)	tan	Rated ripple current (mA _{rms} /85°C, 120Hz)	Part Number	
35(1V)	4.7	5x11	0.12	40	EWK1VM4R7D11OT	
	10	5x11	0.12	55	EWK1VM100D11OT	
	22	5x11	0.12	90	EWK1VM220D11OT	
	33	5x11	0.12	110	EWK1VM330D11OT	
	47	5x11	0.12	135	EWK1VM470D11OT	
	100	6.3x11	0.12	215	EWK1VM101E11OT	
	220	8x12	0.12	385	EWK1VM221F12OT	
	330	10x12.5	0.12	500	EWK1VM331G1BOT	
	470	10x16	0.12	680	EWK1VM471G16OT	
	1000	12.5x20	0.12	1180	EWK1VM102W20OT	
	2200	16x25	0.14	1810	EWK1VM222L25OT	
	3300	16x35	0.16	2300	EWK1VM332L35OT	
	4700	18x35	0.18	2750	EWK1VM472M35OT	
	50(1H)	0.1	5x11	0.10	1.3	EWK1HMR10D11OT
0.22		5x11	0.10	2.9	EWK1HMR22D11OT	
0.33		5x11	0.10	4.3	EWK1HMR33D11OT	
0.47		5x11	0.10	7.0	EWK1HMR47D11OT	
1		5x11	0.10	17	EWK1HM010D11OT	
2.2		5x11	0.10	28	EWK1HM2R2D11OT	
3.3		5x11	0.10	35	EWK1HM3R3D11OT	
4.7		5x11	0.10	41	EWK1HM4R7D11OT	
10		5x11	0.10	60	EWK1HM100D11OT	
22		5x11	0.10	95	EWK1HM220D11OT	
33		6.3x11	0.10	130	EWK1HM330E11OT	
47		6.3x11	0.10	160	EWK1HM470E11OT	
100		8x11	0.10	270	EWK1HM101F11OT	
220		10x16	0.10	435	EWK1HM221G16OT	
330	10x20	0.10	590	EWK1HM331G20OT		
470	10x20	0.10	760	EWK1HM471G20OT		
1000	12.5x25	0.10	1350	EWK1HM102W25OT		
2200	16x35	0.12	2110	EWK1HM222L35OT		
3300	18x35	0.14	2550	EWK1HM332M35OT		
63(1J)	4.7	5x11	0.09	45	EWK1JM4R7D11OT	
	10	5x11	0.09	70	EWK1JM100D11OT	
	22	6.3x11	0.09	110	EWK1JM220E11OT	
	33	6.3x11	0.09	140	EWK1JM330E11OT	
	47	6.3x12	0.09	190	EWK1JM470E12OT	
	100	10x12.5	0.09	300	EWK1JM101G1BOT	
	220	10x16	0.09	490	EWK1JM221G16OT	
	330	10x20	0.09	710	EWK1JM331G20OT	
	470	12.5x20	0.09	900	EWK1JM471W20OT	
	1000	16x25	0.09	1350	EWK1JM102L25OT	
	2200	18x35	0.11	2330	EWK1JM222M35OT	
	100(1K)	0.1	5x11	0.08	2.1	EWK1KMR10D11OT
		0.22	5x11	0.08	4.7	EWK1KMR22D11OT
		0.33	5x11	0.08	7.0	EWK1KMR33D11OT
0.47		5x11	0.08	10	EWK1KMR47D11OT	
1		5x11	0.08	21	EWK1KM010D11OT	
2.2		5x11	0.08	35	EWK1KM2R2D11OT	
3.3		5x11	0.08	45	EWK1KM3R3D11OT	
4.7		5x11	0.08	50	EWK1KM4R7D11OT	
10		6.3x11	0.08	75	EWK1KM100E11OT	
22		8x11	0.08	135	EWK1KM220F11OT	
33		8x12	0.08	185	EWK1KM330F12OT	

WK series

■ STANDARD RATINGS

WV (Vdc)	Cap (μF)	Size DxDL(mm)	tan	Rated ripple current (mA _{RMS} /85°C, 120Hz)	Part Number
100(1K)	47	10x12.5	0.08	235	EWK1KM470G1BOT
	100	10x20	0.08	380	EWK1KM101G20OT
	220	12.5x 25	0.08	630	EWK1KM221W25OT
	330	12.5x 30	0.08	760	EWK1KM331W30OT
	470	16x30	0.08	1000	EWK1KM471L30OT
	1000	18x40	0.08	1350	EWK1KM102M40OT
160(2C)	0.47	6.3x11	0.20	10	EWK2CMR47E11OT
	1	6.3x11	0.20	15	EWK2CM010E11OT
	2.2	6.3x11	0.20	30	EWK2CM2R2E11OT
	3.3	6.3x11	0.20	40	EWK2CM3R3E11OT
	4.7	6.3x11	0.20	48	EWK2CM4R7E11OT
	10	8x12	0.20	80	EWK2CM100F12OT
		10x12	0.20	94	EWK2CM100G12OT
	22	10x12	0.20	130	EWK2CM220G12OT
		10x16	0.20	150	EWK2CM220G16OT
	33	10x20	0.20	170	EWK2CM220G20OT
		10x16	0.20	180	EWK2CM330G16OT
	47	10x20	0.20	210	EWK2CM330G20OT
		10x20	0.20	240	EWK2CM470G20OT
	68	12.5x20	0.20	280	EWK2CM470W20OT
		12.5x20	0.20	360	EWK2CM680W20OT
	100	12.5x25	0.20	470	EWK2CM101W25OT
	150	16x20	0.20	520	EWK2CM151L20OT
	180	16x25	0.20	600	EWK2CM181L25OT
	220	16x30	0.20	780	EWK2CM221L30OT
	270	18x30	0.20	860	EWK2CM271M30OT
330	18x35	0.20	1000	EWK2CM331M35OT	
390	18x35	0.20	1020	EWK2CM391M35OT	
470	18x40	0.20	1220	EWK2CM471M40OT	
200(2D)	0.47	6.3x11	0.20	10	EWK2DMR47E11OT
	1	6.3x11	0.20	15	EWK2DM010E11OT
	2.2	6.3x11	0.20	34	EWK2DM2R2E11OT
	3.3	6.3x11	0.20	45	EWK2DM3R3E11OT
	4.7	6.3x11	0.20	55	EWK2DM4R7E11OT
	10	8x12	0.20	60	EWK2DM4R7F12OT
		10x12	0.20	100	EWK2DM100G12OT
	22	10x20	0.20	170	EWK2DM220G20OT
	33	10x20	0.20	205	EWK2DM330G20OT
	47	12.5x20	0.20	270	EWK2DM470W20OT
	68	12.5x25	0.20	370	EWK2DM680W25OT
	100	16x25	0.20	475	EWK2DM101L25OT
	150	16x25	0.20	550	EWK2DM151L25OT
	180	18x25	0.20	620	EWK2DM181M25OT
	220	18x35	0.20	810	EWK2DM221M35OT
270	18x35	0.20	870	EWK2DM271M35OT	
330	18x35	0.20	1000	EWK2DM331M35OT	
	18x40	0.20	1020	EWK2DM331M40OT	
250(2E)	0.47	6.3x11	0.20	10	EWK2EMR47E11OT
	1	6.3x11	0.20	16	EWK2EM010E11OT
	2.2	6.3x11	0.20	34	EWK2EM2R2E11OT
	3.3	6.3x11	0.20	42	EWK2EM3R3E11OT
		8x12	0.20	46	EWK2EM3R3F12OT
	4.7	6.3x11	0.20	50	EWK2EM4R7E11OT
		8x12	0.20	55	EWK2EM4R7F12OT
	10	10x12	0.20	100	EWK2EM100G12OT
		10x16	0.20	105	EWK2EM100G16OT
	22	10x20	0.20	170	EWK2EM220G20OT

WV (Vdc)	Cap (μF)	Size DxDL(mm)	tan	Rated ripple current (mA _{RMS} /85°C, 120Hz)	Part Number
250(2E)	33	10x20	0.20	200	EWK2EM330G20OT
		12.5x20	0.20	230	EWK2EM330W20OT
	47	12.5x20	0.20	270	EWK2EM470W20OT
		12.5x25	0.20	295	EWK2EM470W25OT
	68	16x25	0.20	382	EWK2EM680L25OT
	100	16x25	0.20	450	EWK2EM101L25OT
		16x30	0.20	515	EWK2EM101L30OT
	120	16x30	0.20	530	EWK2EM121L30OT
150	16x30	0.20	570	EWK2EM151L30OT	
180	18x30	0.20	620	EWK2EM181M30OT	
350(2V)	0.47	6.3x11	0.24	15	EWK2VMR47E11OT
	1	6.3x11	0.24	22	EWK2VM010E11OT
	2.2	8x12	0.24	38	EWK2VM2R2F12OT
	3.3	8x12	0.24	46	EWK2VM3R3F12OT
	4.7	10x12	0.24	65	EWK2VM4R7G12OT
		10x12	0.24	90	EWK2VM100G12OT
	10	10x16	0.24	100	EWK2VM100G16OT
		10x20	0.24	120	EWK2VM100G20OT
	22	12.5x20	0.24	185	EWK2VM220W20OT
	33	16x25	0.24	275	EWK2VM330L25OT
	47	16x25	0.24	325	EWK2VM470L25OT
	68	16x25	0.24	405	EWK2VM680L25OT
	100	18x30	0.24	530	EWK2VM101M30OT
	400(2G)	1	6.3x11	0.24	22
2.2		8x12	0.24	38	EWK2GM2R2F12OT
3.3		10x12	0.24	54	EWK2GM3R3G12OT
4.7		10x12	0.24	60	EWK2GM4R7G12OT
		10x16	0.24	75	EWK2GM4R7G16OT
10		10x16	0.24	100	EWK2GM100G16OT
		10x20	0.24	120	EWK2GM100G20OT
22		12.5x25	0.24	205	EWK2GM220W25OT
33		16x25	0.24	275	EWK2GM330L25OT
47		16x25	0.24	325	EWK2GM470L25OT
56	16x30	0.24	385	EWK2GM560L30OT	
68	18x25	0.24	420	EWK2GM680M25OT	
82	18x30	0.24	475	EWK2GM820M30OT	
100	18x35	0.24	545	EWK2GM101M35OT	
450(2W)	1	8x12	0.24	16	EWK2WM010F12OT
	2.2	8x12	0.24	32	EWK2WM2R2F12OT
		10x12	0.24	35	EWK2WM2R2G12OT
	3.3	10x12	0.24	40	EWK2WM3R3G12OT
		10x16	0.24	44	EWK2WM3R3G16OT
	4.7	10x12	0.24	50	EWK2WM4R7G12OT
		10x16	0.24	58	EWK2WM4R7G16OT
	10	10x20	0.24	65	EWK2WM4R7G20OT
		10x20	0.24	80	EWK2WM100G20OT
	22	12.5x20	0.24	92	EWK2WM100W20OT
		12.5x25	0.24	150	EWK2WM220W25OT
	33	16x25	0.24	165	EWK2WM220L25OT
		16x30	0.24	215	EWK2WM330L30OT
	47	16x30	0.24	260	EWK2WM470L30OT
16x35		0.24	280	EWK2WM470L35OT	
68	18x30	0.24	370	EWK2WM680M30OT	
82	18x35	0.24	390	EWK2WM820M35OT	
100	18x40	0.24	420	EWK2WM101M40OT	

Radial Type

WH series

- Standard series for general purpose
- Wide temperature range from -40 °C to +105 °C
- Endurance: +105 °C 2,000 hours
- RoHS Compliant



SPECIFICATIONS

Items	Characteristics														
Category Temperature Range	-40~+105 °C (6.3~400 V _{dc})						-25~+105°C(450~500 V _{dc})								
Rated Voltage Range	6.3~500 V _{dc}														
Capacitance Tolerance	±20%(M) (at 20°C, 120Hz)														
Leakage Current	6.3~100 V _{dc}						160~500 V _{dc}						Where, I:Max. leakage current (μA), C:Nominal capacitance (μF), V: Rated voltage (V) (at 20°C)		
	I 0.03CV or 4μA (at 1 minute)						CV							After 1 minute	After 5 minutes
	I 0.01CV or 3μA (at 2 minutes) Whichever is greater						CV 1,000							I 0.1CV+40μA	I 0.03CV+15μA
Dissipation Factor (tan)	Rated Voltage(V _{dc})	6.3	10	16	25	35	50	63	100	160~250	350~400	450	500		
	tan (max.)	0.26	0.19	0.16	0.14	0.12	0.10	0.09	0.08	0.20	0.24	0.24	0.24		
	When nominal capacitance exceeds 1,000μF, add 0.02 to the value above for each 1,000μF increase. (at 20°C, 120Hz)														
Low Temperature Characteristics (Max. Impedance Ratio)	Rated Voltage(V _{dc})	6.3	10	16	25	35	50	63	100	160~250	350~400	450	500		
	Z(-25°C)/Z(+20°C)	5	4	3			2			3	6	6	8		
	Z(-40°C)/Z(+20°C)	12	10	8	5	4		3		7	10	-	-		
Endurance	The following specifications shall be satisfied when the capacitors are restored to 20°C after DC voltage plus the rated ripple current is applied for 2,000 hours at 105°C.														
	Capacitance Change	±20% of the initial value													
	D.F. (tan)	200% of the initial specified value													
Shelf Life	The following specifications shall be satisfied when the capacitors are restored to 20°C after exposing them for 1,000 hours at 105°C without voltage applied.														
	Capacitance Change	±20% of the initial value													
	D.F. (tan)	200% of the initial specified value													
Leakage Current	The initial specified value														

DIMENSIONS[mm]

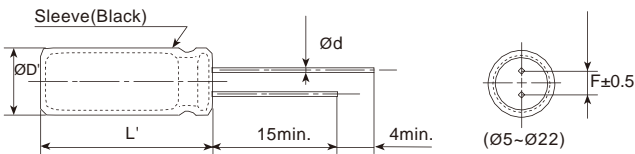

ØD	5	6.3	8	10	12.5	16	18	22
Ød	0.5	0.5	0.5	0.6	0.6	0.8	0.8	0.8
F	2.0	2.5	3.5	5.0	5.0	7.5	7.5	10.0
ØD'	ØD+0.5max.							
L'	L+2max.							

PART NUMBERING SYSTEM

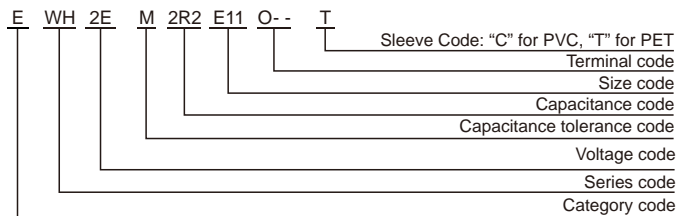

RATED RIPPLE CURRENT MULTIPLIERS

Frequency correction factor for ripple current

Cap.(μF) \ Freq.(Hz)	50	120	300	1k	10k	100k
Cap.<10	0.65	1.00	1.35	1.75	2.30	2.50
10 Cap.<100	0.75	1.00	1.25	1.50	1.75	1.80
100 Cap. 1000	0.80	1.00	1.15	1.30	1.40	1.50
Cap.>1000	0.85	1.00	1.03	1.05	1.08	1.08

The endurance of capacitors is shortened with internal heating produced by ripple current at the rate of halving the lifetime with every 5 °C rise. When long life performance is required in actual use, the rms ripple current has to be reduced.

WH series

■ STANDARD RATINGS

WV (Vdc)	Cap (μF)	Size DxL(mm)	tan	Rated ripple current (mA _{RMS} /105°C, 120Hz)	Part Number
6.3(0J)	33	5x11	0.26	54	EWHOJM330D11OT
	47	5x11	0.26	64	EWHOJM470D11OT
	100	5x11	0.26	94	EWHOJM101D11OT
	220	5x11	0.26	140	EWHOJM221D11OT
	330	6.3x11	0.26	190	EWHOJM331E11OT
	470	6.3x11	0.26	230	EWHOJM471E11OT
	1000	8x12	0.26	380	EWHOJM102F12OT
	2200	10x20	0.28	710	EWHOJM222G20OT
	3300	10x20	0.30	840	EWHOJM332G20OT
	4700	12.5x20	0.32	1090	EWHOJM472W20OT
	6800	12.5x25	0.36	1350	EWHOJM682W25OT
	10000	16x25	0.44	1650	EWHOJM103L25OT
	15000	16x35	0.54	2010	EWHOJM153L35OT
	22000	18x40	0.68	2350	EWHOJM223M40OT
10(1A)	22	5x11	0.19	46	EWH1AM220D11OT
	33	5x11	0.19	57	EWH1AM330D11OT
	47	5x11	0.19	68	EWH1AM470D11OT
	100	5x11	0.19	100	EWH1AM101D11OT
	220	6.3x11	0.19	170	EWH1AM221E11OT
	330	6.3x11	0.19	200	EWH1AM331E11OT
	470	8x11	0.19	250	EWH1AM471F11OT
	1000	10x12.5	0.19	460	EWH1AM102G1BOT
	2200	10x20	0.21	760	EWH1AM222G20OT
	3300	12.5x20	0.23	1000	EWH1AM332W20OT
	4700	12.5x25	0.25	1260	EWH1AM472W25OT
	6800	16x25	0.29	1570	EWH1AM682L25OT
	10000	16x35	0.37	1890	EWH1AM103L35OT
	15000	18x35	0.47	2180	EWH1AM153M35OT
16(1C)	10	5x11	0.16	34	EWH1CM100D11OT
	22	5x11	0.16	51	EWH1CM220D11OT
	33	5x11	0.16	63	EWH1CM330D11OT
	47	5x11	0.16	75	EWH1CM470D11OT
	100	5x11	0.16	110	EWH1CM101D11OT
	220	6.3x11	0.16	180	EWH1CM221E11OT
	330	8x11	0.16	260	EWH1CM331F11OT
	470	8x12	0.16	310	EWH1CM471F12OT
	1000	10x16	0.16	560	EWH1CM102G1BOT
	2200	12.5x20	0.18	920	EWH1CM222W20OT
	3300	12.5x25	0.20	1170	EWH1CM332W25OT
	4700	16x25	0.22	1480	EWH1CM472L25OT
	6800	16x30	0.26	1780	EWH1CM682L30OT
	10000	18x35	0.34	2060	EWH1CM103M35OT
25(1E)	4.7	5x11	0.14	25	EWH1EM4R7D11OT
	10	5x11	0.14	36	EWH1EM100D11OT
	22	5x11	0.14	54	EWH1EM220D11OT
	33	5x11	0.14	67	EWH1EM330D11OT
	47	5x11	0.14	80	EWH1EM470D11OT
	100	6.3x11	0.14	130	EWH1EM101E11OT
	220	8x11	0.14	230	EWH1EM221F11OT
	330	8x12	0.14	310	EWH1EM331F12OT
	470	10x12.5	0.14	380	EWH1EM471G1BOT
	1000	10x20	0.14	680	EWH1EM102G20OT
	2200	12.5x25	0.16	1090	EWH1EM222W25OT
	3300	16x25	0.18	1400	EWH1EM332L25OT
	4700	16x30	0.20	1710	EWH1EM472L30OT
	6800	18x35	0.24	2040	EWH1EM682M35OT

WV (Vdc)	Cap (μF)	Size DxL(mm)	tan	Rated ripple current (mA _{RMS} /105°C, 120Hz)	Part Number
35(1V)	4.7	5x11	0.12	28	EWH1VM4R7D11OT
	10	5x11	0.12	41	EWH1VM100D11OT
	22	5x11	0.12	61	EWH1VM220D11OT
	33	5x11	0.12	75	EWH1VM330D11OT
	47	5x11	0.12	90	EWH1VM470D11OT
	100	6.3x11	0.12	150	EWH1VM101E11OT
	220	8x12	0.12	270	EWH1VM221F12OT
	330	10x12.5	0.12	350	EWH1VM331G1BOT
	470	10x16	0.12	460	EWH1VM471G16OT
	1000	12.5x20	0.12	810	EWH1VM102W20OT
	2200	16x25	0.14	1260	EWH1VM222L25OT
	3300	16x35	0.16	1610	EWH1VM332L35OT
	4700	18x35	0.18	1910	EWH1VM472M35OT
	50(1H)	0.10	5x11	0.10	1.3
0.22		5x11	0.10	2.9	EWH1HMR22D11OT
0.33		5x11	0.10	4.3	EWH1HMR33D11OT
0.47		5x11	0.10	6.2	EWH1HMR47D11OT
1.0		5x11	0.10	13	EWH1HM010D11OT
2.2		5x11	0.10	20	EWH1HM2R2D11OT
3.3		5x11	0.10	25	EWH1HM3R3D11OT
4.7		5x11	0.10	30	EWH1HM4R7D11OT
10		5x11	0.10	40	EWH1HM100D11OT
22		5x11	0.10	65	EWH1HM220D11OT
33		6.3x11	0.10	90	EWH1HM330E11OT
47		6.3x11	0.10	110	EWH1HM470E11OT
100		8x11	0.10	180	EWH1HM101F11OT
220		10x12.5	0.10	300	EWH1HM221G1BOT
330	10x16	0.10	410	EWH1HM331G16OT	
470	10x20	0.10	530	EWH1HM471G20OT	
1000	12.5x25	0.10	950	EWH1HM102W25OT	
2200	16x35	0.12	1470	EWH1HM222L35OT	
3300	18x35	0.14	1770	EWH1HM332M35OT	
63(1J)	10	5x11	0.09	46	EWH1JM100D11OT
	22	5x11	0.09	71	EWH1JM220D11OT
	33	6.3x11	0.09	100	EWH1JM330E11OT
	47	6.3x11	0.09	120	EWH1JM470E11OT
	100	10x12.5	0.09	215	EWH1JM101G1BOT
	220	10x16	0.09	335	EWH1JM221G16OT
	330	10x20	0.09	510	EWH1JM331G20OT
	470	12.5x20	0.09	640	EWH1JM471W20OT
	1000	16x25	0.09	930	EWH1JM102L25OT
	100(1K)	0.10	5x11	0.08	1.5
0.22		5x11	0.08	3.4	EWH1KMR22D11OT
0.33		5x11	0.08	5.0	EWH1KMR33D11OT
0.47		5x11	0.08	7.1	EWH1KMR47D11OT
1.0		5x11	0.08	15	EWH1KM010D11OT
2.2		5x11	0.08	21	EWH1KM2R2D11OT
3.3		5x11	0.08	29	EWH1KM3R3D11OT
4.7		5x11	0.08	32	EWH1KM4R7D11OT
10		6.3x11	0.08	54	EWH1KM100E11OT
22		8x11	0.08	93	EWH1KM220F11OT
33		8x12	0.08	130	EWH1KM330F12OT
47		10x12.5	0.08	165	EWH1KM470G1BOT
100		10x20	0.08	265	EWH1KM101G20OT
220		12.5x25	0.08	440	EWH1KM221W25OT

WH series

■ STANDARD RATINGS

WV (Vdc)	Cap (μF)	Size DxL(mm)	tan	Rated ripple current (mA _{rms} /105°C, 120Hz)	Part Number
100(1K)	330	16x25	0.08	540	EW11KM331L25OT
	470	16x30	0.08	715	EW11KM471L30OT
	1000	18x40	0.08	985	EW11KM102M40OT
160(2C)	3.3	6.3x11	0.20	32	EW22CM3R3E11OT
	4.7	6.3x11	0.20	38	EW22CM4R7E11OT
	10	8x12	0.20	65	EW22CM100F12OT
		10x12	0.20	76	EW22CM100G12OT
		10x12	0.20	98	EW22CM220G12OT
	22	10x16	0.20	108	EW22CM220G16OT
		10x20	0.20	120	EW22CM220G20OT
		10x16	0.20	158	EW22CM330G16OT
	33	10x20	0.20	165	EW22CM330G20OT
		10x20	0.20	182	EW22CM470G20OT
		12.5x20	0.20	205	EW22CM470W20OT
	47	12.5x20	0.20	265	EW22CM680W20OT
12.5x25		0.20	318	EW22CM101W25OT	
100	16x25	0.20	335	EW22CM101L25OT	
	220	16x30	0.20	568	EW22CM221L30OT
330	18x35	0.20	710	EW22CM331M35OT	
	470	18x40	0.20	870	EW22CM471M40OT
200(2D)	1	6.3x11	0.20	16	EW22DM010E11OT
	2.2	6.3x11	0.20	22	EW22DM2R2E11OT
	3.3	6.3x11	0.20	32	EW22DM3R3E11OT
	4.7	8x12	0.20	48	EW22DM4R7F12OT
		8x12	0.20	78	EW22DM100F12OT
	10	10x12	0.20	82	EW22DM100G12OT
		10x16	0.20	86	EW22DM100G16OT
		10x16	0.20	128	EW22DM220G16OT
	22	10x20	0.20	132	EW22DM220G20OT
		10x20	0.20	185	EW22DM330G20OT
	33	12.5x20	0.20	194	EW22DM330W20OT
		12.5x20	0.20	225	EW22DM470W20OT
	68	12.5x25	0.20	308	EW22DM680W25OT
	82	12.5x25	0.20	318	EW22DM820W25OT
	100	16x25	0.20	345	EW22DM101L25OT
	150	16x25	0.20	446	EW22DM151L25OT
	180	16x30	0.20	560	EW22DM181L30OT
	220	16x35	0.20	678	EW22DM221L35OT
		18x30	0.20	695	EW22DM221M30OT
	330	18x35	0.20	755	EW22DM331M35OT
470		18x45	0.20	938	EW22DM471M45OT
250(2E)	2.2	6.3x11	0.20	22	EW22EM2R2E11OT
	3.3	6.3x11	0.20	32	EW22EM3R3E11OT
		8x12	0.20	34	EW22EM3R3F12OT
	4.7	6.3x11	0.20	38	EW22EM4R7E11OT
		8x12	0.20	48	EW22EM4R7F12OT
	10	10x12	0.20	75	EW22EM100G12OT
		10x16	0.20	84	EW22EM100G16OT
	22	10x20	0.20	128	EW22EM220G20OT
		12.5x20	0.20	145	EW22EM220W20OT
	33	10x20	0.20	150	EW22EM330G20OT
		12.5x20	0.20	185	EW22EM330W20OT
	47	12.5x20	0.20	232	EW22EM470W20OT
		12.5x25	0.20	245	EW22EM470W25OT
	100	16x25	0.20	370	EW22EM101L25OT
		16x30	0.20	400	EW22EM101L30OT
	150	16x35	0.20	468	EW22EM151L35OT
	220	18x35	0.20	660	EW22EM221M35OT
		18x40	0.20	702	EW22EM221M40OT
330	18x40	0.20	730	EW22EM331M40OT	

WV (Vdc)	Cap (μF)	Size DxL(mm)	tan	Rated ripple current (mA _{rms} /105°C, 120Hz)	Part Number
350(2V)	0.47	6.3x11	0.24	11	EW22VMR47E11OT
	1	6.3x11	0.24	16	EW22VM010E11OT
		8x12	0.24	26	EW22VM2R2F12OT
	3.3	8x12	0.24	34	EW22VM3R3F12OT
		10x12	0.24	38	EW22VM3R3G12OT
	4.7	8x12	0.24	48	EW22VM4R7F12OT
		10x12	0.24	52	EW22VM4R7G12OT
	10	10x12	0.24	68	EW22VM100G12OT
		10x16	0.24	82	EW22VM100G16OT
		10x20	0.24	88	EW22VM100G20OT
	22	12.5x20	0.24	154	EW22VM220W20OT
		12.5x20	0.24	184	EW22VM330W20OT
33	16x20	0.24	198	EW22VM330L20OT	
	16x25	0.24	250	EW22VM470L25OT	
68	16x25	0.24	336	EW22VM680L25OT	
100	18x30	0.24	398	EW22VM101M30OT	
400(2G)	1	6.3x11	0.24	16	EW22GM010E11OT
	2.2	6.3x11	0.24	30	EW22GM2R2E11OT
		8x12	0.24	34	EW22GM2R2F12OT
	3.3	8x12	0.24	35	EW22GM3R3F12OT
		10x12	0.24	38	EW22GM3R3G12OT
	4.7	8x12	0.24	48	EW22GM4R7F12OT
		10x12	0.24	52	EW22GM4R7G12OT
	10	10x16	0.24	98	EW22GM100G16OT
		10x20	0.24	115	EW22GM100G20OT
	22	12.5x25	0.24	192	EW22GM220W25OT
		16x20	0.24	258	EW22GM330L20OT
	47	16x25	0.24	305	EW22GM470L25OT
		16x30	0.24	465	EW22GM680L30OT
	68	18x25	0.24	445	EW22GM680M25OT
		18x25	0.24	474	EW22GM820M25OT
100	16x40	0.24	544	EW22GM101L40OT	
	18x30	0.24	532	EW22GM101M30OT	
120	18x35	0.24	588	EW22GM121M35OT	
150	18x40	0.24	668	EW22GM151M40OT	
450(2W)	0.47	8x12	0.24	11	EW22WMR47F12OT
	1	8x12	0.24	18	EW22WM010F12OT
		8x12	0.24	25	EW22WM2R2F12OT
	2.2	10x12	0.24	32	EW22WM2R2G12OT
		10x12	0.24	36	EW22WM3R3G12OT
	3.3	10x16	0.24	40	EW22WM3R3G16OT
		10x20	0.24	55	EW22WM4R7G20OT
	10	10x20	0.24	90	EW22WM100G20OT
		12.5x20	0.24	100	EW22WM100W20OT
	22	12.5x25	0.24	168	EW22WM220W25OT
		16x20	0.24	185	EW22WM220L20OT
	33	16x25	0.24	215	EW22WM330L25OT
16x30		0.24	344	EW22WM470L30OT	
68	18x30	0.24	455	EW22WM680M30OT	
	18x30	0.24	472	EW22WM820M30OT	
100	18x35	0.24	530	EW22WM101M35OT	
	120	18x40	0.24	582	EW22WM121M40OT
150	18x50	0.24	700	EW22WM151M50OT	
500(2H)	4.7	10x20	0.24	60	EW22HM4R7G20OT
	10	12.5x20	0.24	115	EW22HM100W20OT
		12.5x25	0.24	140	EW22HM150W25OT
	22	16x25	0.24	185	EW22HM220L25OT
		18x25	0.24	215	EW22HM330M25OT
	47	18x35	0.24	345	EW22HM470M35OT
		18x40	0.24	455	EW22HM680M40OT
	82	18x50	0.24	520	EW22HM820M50OT
		100	22x40	0.24	550
	120	22x46	0.24	580	EW22HM121O46OT

HP series

- Standard bi-polarized series
- Endurance: +105°C 1,000 hours
- RoHS Compliant



SPECIFICATIONS

Items	Characteristics									
Category Temperature Range	-40~+105°C									
Rated Voltage Range	6.3~100 V _{dc}									
Capacitance Tolerance	±20%(M) (at 20°C, 120Hz)									
Leakage Current	I 0.06CV or 10μA, whichever is greater. (at 20°C after 2 minutes) I 0.03CV or 3μA, whichever is greater. (at 20°C after 5 minutes) Where, I: Max. leakage current (μA), C: Nominal capacitance (μF), V: Rated voltage (V)									
Dissipation Factor (tan δ)	Rated Voltage(V _{dc})	6.3	10	16	25	35	50	63	100	
	tan δ (max.)	0.24	0.24	0.20	0.20	0.16	0.14	0.12	0.10	
	When nominal capacitance exceeds 1,000μF, add 0.02 to the value above for each 1,000μF increase. (at 20°C, 120Hz)									
Low Temperature Characteristics (Max. Impedance Ratio)	Rated Voltage(V _{dc})	6.3	10	16	25	35	50	63	100	
	Z(-25°C)/Z(+20°C)	4	3	2						
	Z(-40°C)/Z(+20°C)	10	8	6	4	3				
Endurance	The following specifications shall be satisfied when the capacitors are restored to 20°C after the rated voltage is applied for 1,000 hours at 105°C with the polarity inverted every 250 hours.									
	Capacitance Change	±20% of the initial value								
	D.F. (tan δ)	150% of the initial specified value								
	Leakage Current	The initial specified value								
Shelf Life	The following specifications shall be satisfied when the capacitors are restored to 20°C after exposing them for 500 hours at 105°C without voltage applied.									
	Capacitance Change	±20% of the initial value								
	D.F. (tan δ)	150% of the initial specified value								
	Leakage Current	200% of the initial specified value								

DIMENSIONS[mm]

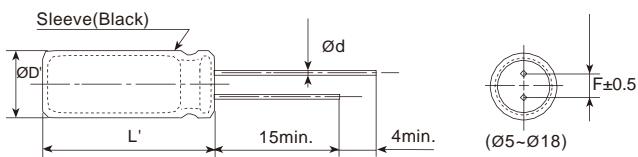

ØD	5	6.3	8		10	12.5	16	18
Ød	0.5	0.5	0.5	0.6	0.6	0.6	0.8	0.8
F	2.0	2.5	3.5		5.0	5.0	7.5	7.5
ØD'	ØD+0.5max.							
L'	L+2max.							

PART NUMBERING SYSTEM

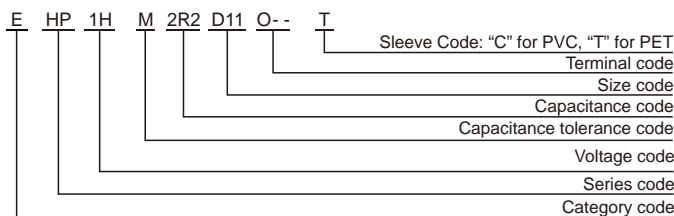

HP series

■ STANDARD RATINGS

WV (Vdc)	Cap (μF)	Size DxL(mm)	tan	Rated ripple current (mA _{rms} /105°C, 120Hz)	Part Number
6.3(0J)	33	5x11	0.24	45	EHP0JM330D11OT
	47	5x11	0.24	54	EHP0JM470D11OT
	100	6.3x11	0.24	90	EHP0JM101E11OT
	220	8x11	0.24	150	EHP0JM221F11OT
	330	8x11	0.24	185	EHP0JM331F11OT
	470	10x12.5	0.24	260	EHP0JM471G1BOT
	1000	10x20	0.24	460	EHP0JM102G20OT
	2200	12.5x25	0.26	820	EHP0JM222W25OT
	3300	16x25	0.28	1110	EHP0JM332L25OT
	4700	16x30	0.30	1430	EHP0JM472L30OT
6800	18x35	0.34	1830	EHP0JM682M35OT	
10(1A)	22	5x11	0.24	37	EHP1AM220D11OT
	33	5x11	0.24	45	EHP1AM330D11OT
	47	5x11	0.24	54	EHP1AM470D11OT
	100	6.3x11	0.24	90	EHP1AM101E11OT
	220	8x11	0.24	150	EHP1AM221F11OT
	330	10x16	0.24	240	EHP1AM331G16OT
	470	10x16	0.24	290	EHP1AM471G16OT
	1000	12.5x20	0.24	510	EHP1AM102W20OT
	2200	16x25	0.26	910	EHP1AM222L25OT
	3300	16x30	0.28	1200	EHP1AM332L30OT
4700	18x35	0.30	1520	EHP1AM472M35OT	
16(1C)	10	5x11	0.20	27	EHP1CM100D11OT
	22	5x11	0.20	40	EHP1CM220D11OT
	33	5x11	0.20	49	EHP1CM330D11OT
	47	6.3x11	0.20	67	EHP1CM470E11OT
	100	8x11	0.20	110	EHP1CM101F11OT
	220	10x12.5	0.20	195	EHP1CM221G1BOT
	330	10x16	0.20	265	EHP1CM331G16OT
	470	10x20	0.20	345	EHP1CM471G20OT
	1000	12.5x25	0.20	605	EHP1CM102W25OT
	2200	16x30	0.22	1070	EHP1CM222L30OT
3300	18x35	0.24	1400	EHP1CM332M35OT	
25(1E)	10	5x11	0.20	27	EHP1EM100D11OT
	22	5x11	0.20	46	EHP1EM220D11OT
	33	6.3x11	0.20	56	EHP1EM330E11OT
	47	6.3x11	0.20	67	EHP1EM470E11OT
	100	8x11	0.20	110	EHP1EM101F11OT
	220	10x16	0.20	215	EHP1EM221G16OT
	330	12.5x20	0.20	320	EHP1EM331W20OT
	470	12.5x20	0.20	380	EHP1EM471W20OT
	1000	16x25	0.20	670	EHP1EM102L25OT
	2200	18x35	0.22	1140	EHP1EM222M35OT
35(1V)	4.7	5x11	0.16	21	EHP1VM47R7D11OT
	10	5x11	0.16	30	EHP1VM100D11OT
	22	6.3x11	0.16	51	EHP1VM220E11OT
	33	8x11	0.16	72	EHP1VM330F11OT
	47	8x11	0.16	86	EHP1VM470F11OT
	100	10x16	0.16	160	EHP1VM101G16OT

WV (Vdc)	Cap (μF)	Size DxL(mm)	tan	Rated ripple current (mA _{rms} /105°C, 120Hz)	Part Number
35(1V)	220	12.5x20	0.16	290	EHP1VM221W20OT
	330	12.5x20	0.16	350	EHP1VM331W20OT
	470	12.5x25	0.16	465	EHP1VM471W25OT
	1000	16x30	0.16	805	EHP1VM102L30OT
	0.47	5x11	0.14	7.0	EHP1HMR47D11OT
50(1H)	1.0	5x11	0.14	10	EHP1HM010D11OT
	2.2	5x11	0.14	15	EHP1HM2R2D11OT
	3.3	5x11	0.14	18	EHP1HM3R3D11OT
	4.7	5x11	0.14	22	EHP1HM4R7D11OT
	10	6.3x11	0.14	37	EHP1HM100E11OT
	22	8x11	0.14	63	EHP1HM220F11OT
	33	8x11	0.14	77	EHP1HM330F11OT
	47	10x12.5	0.14	105	EHP1HM470G1BOT
	100	10x20	0.14	190	EHP1HM101G20OT
	220	12.5x25	0.14	340	EHP1HM221W25OT
63(1J)	330	16x25	0.14	460	EHP1HM331L25OT
	470	16x30	0.14	590	EHP1HM471L30OT
	3.3	5x11	0.12	20	EHP1JM3R3D11OT
	4.7	6.3x11	0.12	24	EHP1JM4R7E11OT
	10	6.3x11	0.12	40	EHP1JM100E11OT
	22	8x11	0.12	68	EHP1JM220F11OT
	33	10x12.5	0.12	98	EHP1JM330G1BOT
	47	10x16	0.12	130	EHP1JM470G16OT
	100	12.5x20	0.12	225	EHP1JM101W20OT
	220	16x25	0.12	405	EHP1JM221L25OT
80(1B)	330	16x30	0.12	535	EHP1JM331L30OT
	470	18x35	0.12	680	EHP1JM471M35OT
	2.2	5x11	0.12	16	EHP1BM2R2D11OT
	3.3	6.3x11	0.12	23	EHP1BM3R3E11OT
	4.7	6.3x11	0.12	27	EHP1BM4R7E11OT
	10	8x11	0.12	46	EHP1BM100F11OT
	22	10x16	0.12	89	EHP1BM220G16OT
	33	10x16	0.12	105	EHP1BM330G16OT
	47	10x20	0.12	140	EHP1BM470G20OT
	100	12.5x25	0.12	245	EHP1BM101W25OT
100(1K)	220	16x30	0.12	435	EHP1BM221L30OT
	330	18x35	0.12	570	EHP1BM331M35OT
	0.47	5x11	0.10	8.0	EHP1KMR47D11OT
	1.0	5x11	0.10	12	EHP1KM010D11OT
	2.2	6.3x11	0.10	20	EHP1KM2R2E11OT
	3.3	6.3x11	0.10	25	EHP1KM3R3E11OT
	4.7	6.3x11	0.10	30	EHP1KM4R7E11OT
	10	8x11	0.10	50	EHP1KM100F11OT
	22	10x16	0.10	97	EHP1KM220G16OT
	33	12.5x20	0.10	140	EHP1KM330W20OT
47	12.5x20	0.10	170	EHP1KM470W20OT	
100	16x25	0.10	300	EHP1KM101L25OT	
220	18x35	0.10	510	EHP1KM221M35OT	

CD11GC series



- Endurance: +130°C 4,000~5,000 hours +105°C 15,000~20,000 hours
- Withstand high temperature, extremely long life
- Suitable for output circuit and input circuit of LED driving power, electronic ballast and electronic energy saving lamp.
- RoHS Compliant

SPECIFICATIONS

Items	Characteristics								
Category Temperature Range	-40~+130°C(160~450 V _{dc})								
Rated Voltage Range	160~450 V _{dc}								
Capacitance Tolerance	±20%(M) (at 20°C,120Hz)								
Leakage Current	160~400 V _{dc}	450 V _{dc}		Where, I: Max.leakage current (μA),C:Nominal capacitance (μF), V: Rated voltage (V)				(at 20°C after 2 minutes)	
	I 0.02CV+10μA	I 0.03CV+10μA							
Dissipation Factor (tan δ)	Rated Voltage(V _{dc})	160	200	250	350	400	450	(at 20°C,120Hz)	
	tan δ (max.)	0.15	0.15	0.15	0.20	0.20	0.20		
Low Temperature Characteristics (Max. Impedance Ratio)	Rated Voltage(V _{dc})	160	200	250	350	400	450	(at 120Hz)	
	Z(-25°C)/Z(+20°C)	3	3	3	5	5	6		
	Z(-40°C)/Z(+20°C)	6	6	6	6	6	9		
Endurance	The specifications listed below shall be met when the capacitors are restored to 20°C after DC voltage plus rated ripple current is applied for a specified period of time at 130°C or 105°C, the peak voltage shall not exceed the rated voltage.								
	Capacitance Change	±30% of the initial value					Height (mm)	130°C Load life (hours)	105°C Load life (hours)
	D.F. (tan δ)	300% of the initial specified value					L 10	4,000	15,000
	Leakage Current	The initial specified value					L>10	5,000	20,000
Shelf Life	The following specifications shall be satisfied when the capacitors are restored to 20°C after leaving them under no load at 105°C for 1,000 hours.								
	Capacitance Change	±20% of the initial value							
	D.F. (tan δ)	200% of the initial specified value							
	Leakage Current	200% of the initial specified value							

DIMENSIONS[mm]

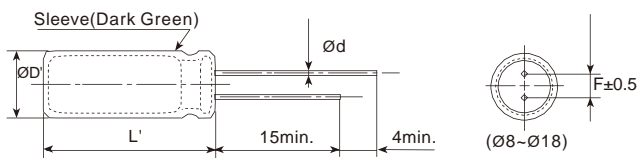

ØD	8	10	12.5	16	18
Ød	0.5	0.6	0.6	0.8	0.8
F	3.5	5.0	5.0	7.5	7.5
ØD'	ØD+0.5max.				
L'	L+2max.				

PART NUMBERING SYSTEM

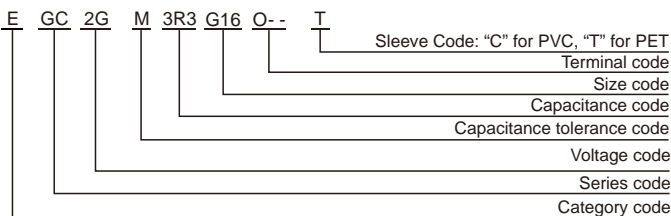

RATED RIPPLE CURRENT MULTIPLIERS

Frequency correction factor for ripple current

	Freq.(Hz)	120	1k	10k	100k
Rated voltage(V _{dc})	160~450	0.50	0.80	0.90	1.00

CD11GC series

■ STANDARD RATINGS (Rated ripple current:mArms/130°C 100kHz)

WV (Vdc)	Cap (μF)	Size DxL(mm)	Rated ripple current	Part Number
160(2C)	3.3	8x12	70	EGC2CM3R3F12OT
	4.7	8x12	77	EGC2CM4R7F12OT
		8x16	82	EGC2CM5R6F16OT
	5.6	10x9	80	EGC2CM5R6G09OT
	6.8	8x16	88	EGC2CM6R8F16OT
		10x9	145	EGC2CM8R2G09OT
	8.2	10x16	183	EGC2CM8R2G16OT
		10x9	190	EGC2CM100G09OT
	10	10x16	223	EGC2CM100G16OT
		15	10x16	300
	22	10x20	400	EGC2CM220G20OT
	33	12.5x20	480	EGC2CM330W20OT
	47	12.5x25	590	EGC2CM470W25OT
	68	16x25	750	EGC2CM680L25OT
	82	16x25	825	EGC2CM820L25OT
		16x25	960	EGC2CM101L25OT
	100	18x20	960	EGC2CM101M20OT
		18x30	1050	EGC2CM151M30OT
220	18x35	1500	EGC2CM221M35OT	
200(2D)	2.8	8x12	64	EGC2DM2R8F12OT
	3.3	8x12	73	EGC2DM3R3F12OT
		8x16	126	EGC2DM4R7F16OT
	4.7	10x9	100	EGC2DM4R7G09OT
		10x12	126	EGC2DM4R7G12OT
	5.6	8x16	148	EGC2DM5R6F16OT
		10x9	120	EGC2DM5R6G09OT
	6.8	8x16	160	EGC2DM6R8F16OT
		10x9	145	EGC2DM6R8G09OT
	8.2	10x16	200	EGC2DM6R8G16OT
		10x9	165	EGC2DM8R2G09OT
	10	10x16	203	EGC2DM8R2G16OT
		10x9	215	EGC2DM100G09OT
	10	10x16	230	EGC2DM100G16OT
		10x20	245	EGC2DM100G20OT
	15	10x20	327	EGC2DM150G20OT
	22	12.5x20	430	EGC2DM220W20OT
	33	12.5x20	500	EGC2DM330W20OT
	47	12.5x25	650	EGC2DM470W25OT
		16x20	650	EGC2DM470L20OT
68	16x25	750	EGC2DM680L25OT	
82	16x30	900	EGC2DM820L30OT	
	18x25	900	EGC2DM820M25OT	
100	16x30	1100	EGC2DM101L30OT	
	18x25	1100	EGC2DM101M25OT	
150	18x35	1350	EGC2DM151M35OT	
250(2E)	2.2	8x12	64	EGC2EM2R2F12OT
	2.8	8x12	72	EGC2EM2R8F12OT
	3.3	8x12	80	EGC2EM3R3F12OT
	4.7	8x16	133	EGC2EM4R7F16OT
		10x9	120	EGC2EM5R6G09OT
	5.6	10x16	150	EGC2EM5R6G16OT
		10x16	169	EGC2EM6R8G16OT
	6.8	10x9	165	EGC2EM8R2G09OT
		10x16	203	EGC2EM8R2G16OT
	10	10x16	238	EGC2EM100G16OT
		10x20	250	EGC2EM100G20OT
	15	10x20	327	EGC2EM150G20OT
	22	12.5x20	430	EGC2EM220W20OT
	33	12.5x25	530	EGC2EM330W25OT
		16x20	530	EGC2EM330L20OT
	47	16x25	690	EGC2EM470L25OT
		18x20	690	EGC2EM470M20OT
	68	16x30	780	EGC2EM680L30OT
		18x25	780	EGC2EM680M25OT
	82	18x25	900	EGC2EM820M25OT
100	18x30	970	EGC2EM101M30OT	

WV (Vdc)	Cap (μF)	Size DxL(mm)	Rated ripple current	Part Number
350(2V)	1	8x12	49	EGC2VM010F12OT
	1.5	8x16	73	EGC2VM1R5F16OT
		8x16	75	EGC2VM1R8F16OT
	1.8	10x9	65	EGC2VM1R8G09OT
		10x9	75	EGC2VM2R2G09OT
	2.2	10x16	90	EGC2VM2R2G16OT
		10x16	95	EGC2VM2R8G16OT
	3.3	10x16	100	EGC2VM3R3G16OT
	4.7	10x20	142	EGC2VM4R7G20OT
	5.6	10x20	152	EGC2VM5R6G20OT
		12.5x20	165	EGC2VM5R6W20OT
	6.8	10x20	190	EGC2VM6R8G20OT
		12.5x20	200	EGC2VM6R8W20OT
	8.2	12.5x20	205	EGC2VM8R2W20OT
		12.5x20	250	EGC2VM100W20OT
	10	12.5x25	270	EGC2VM100W25OT
		12.5x25	335	EGC2VM150W25OT
	15	16x20	335	EGC2VM150L20OT
16x25		450	EGC2VM220L25OT	
33	16x30	535	EGC2VM330L30OT	
	16x35	555	EGC2VM330L35OT	
47	18x30	700	EGC2VM470M30OT	
	18x35	750	EGC2VM470M35OT	
68	18x40	900	EGC2VM680M40OT	
400(2G)	1	8x12	54	EGC2GM010F12OT
	1.5	8x16	60	EGC2GM010F16OT
		8x16	73	EGC2GM1R5F16OT
	1.8	8x16	75	EGC2GM1R8F16OT
		10x9	65	EGC2GM1R8G09OT
	2.2	10x9	76	EGC2GM2R2G09OT
		10x16	92	EGC2GM2R2G16OT
	2.8	10x16	100	EGC2GM2R8G16OT
		10x16	105	EGC2GM3R3G16OT
	3.3	10x20	120	EGC2GM3R3G20OT
		10x20	142	EGC2GM4R7G20OT
	4.7	12.5x20	150	EGC2GM4R7W20OT
		12.5x20	165	EGC2GM5R6W20OT
	6.8	12.5x20	225	EGC2GM6R8W20OT
		12.5x20	230	EGC2GM8R2W20OT
	10	12.5x25	280	EGC2GM100W25OT
		12.5x25	335	EGC2GM150W25OT
	15	16x20	335	EGC2GM150L20OT
		16x25	480	EGC2GM220L25OT
	22	16x30	500	EGC2GM220L30OT
18x30		635	EGC2GM330M30OT	
47	18x35	750	EGC2GM470M35OT	
	18x40	900	EGC2GM680M40OT	
100	18x50	1030	EGC2GM101M50OT	
450(2W)	1.5	8x16	70	EGC2WM1R5F16OT
	1.8	8x16	74	EGC2WM1R8F16OT
		10x16	77	EGC2WM2R2G16OT
	2.8	10x16	80	EGC2WM2R8G16OT
		10x16	88	EGC2WM3R3G16OT
	3.3	10x20	92	EGC2WM3R3G20OT
		10x20	104	EGC2WM4R7G20OT
	5.6	12.5x20	144	EGC2WM5R6W20OT
		12.5x20	175	EGC2WM6R8W20OT
	8.2	12.5x20	183	EGC2WM8R2W20OT
		12.5x20	225	EGC2WM100W20OT
	15	12.5x25	294	EGC2WM150W25OT
		16x25	395	EGC2WM220L25OT
	22	16x30	420	EGC2WM220L30OT
		18x30	500	EGC2WM330M30OT
	47	18x35	615	EGC2WM470M35OT
		18x40	710	EGC2WM680M40OT
	100	18x50	840	EGC2WM101M50OT

CD11GES series

- Endurance: +130°C 3,000 hours +105°C 12,000 hours
- Withstand high temperature 130°C, miniaturized and long life
- Suitable for output circuit and input circuit of LED driving power, electronic ballast and electronic energy saving lamp.
- **RoHS Compliant**



SPECIFICATIONS

Items	Characteristics							
Category Temperature Range	-40~+130°C(160~ 450 V _{dc})				-40~+105°C(500 V _{dc})			
Rated Voltage Range	160~500 V _{dc}							
Capacitance Tolerance	±20%(M) (at 20°C,120Hz)							
Leakage Current	160~400 V _{dc}	450~500 V _{dc}		Where, I: Max.leakage current (μA),C:Nominal capacitance (μF), V: Rated voltage (V)				
	I 0.02CV+10μA	I 0.03CV+10μA		(at 20°C after 2 minutes)				
Dissipation Factor (tan δ)	Rated Voltage(V _{dc})	160	200	250	350	400	450	500
	tan δ (max.)	0.15	0.15	0.15	0.20	0.20	0.20	0.24
Low Temperature Characteristics (Max. Impedance Ratio)	Rated Voltage(V _{dc})	160	200	250	350	400	450	500
	Z(-25°C)/Z(+20°C)	3	3	3	5	5	6	6
	Z(-40°C)/Z(+20°C)	6	6	6	6	6	9	15
Endurance	The specifications listed below shall be met when the capacitors are restored to 20°C after DC voltage is applied for 3,000 hours (VV:160~450V) at 130°C or after DC voltage with the rated ripple current is applied for 12,000 hours at 105°C (500V: 10,000 hours), the peak voltage shall not exceed the rated voltage.							
	Capacitance Change	±20% of the initial value						
	D.F. (tan δ)	200% of the initial specified value						
	Leakage Current	The initial specified value						
Shelf Life	The following specifications shall be satisfied when the capacitors are restored to 20°C after leaving them under no load at 105°C for 1,000 hours.							
	Capacitance Change	±20% of the initial value						
	D.F. (tan δ)	200% of the initial specified value						
	Leakage Current	200% of the initial specified value						

DIMENSIONS[mm]

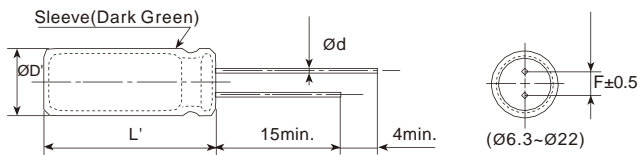

ØD	6.3	8	10	12.5	16	18	22
Ød	0.5	0.5	0.6	0.6	0.6	0.8	0.8
F	2.5	3.5	5.0	5.0	7.5	7.5	10
ØD'	ØD+0.5max.						
L'	L+2max.						

PART NUMBERING SYSTEM

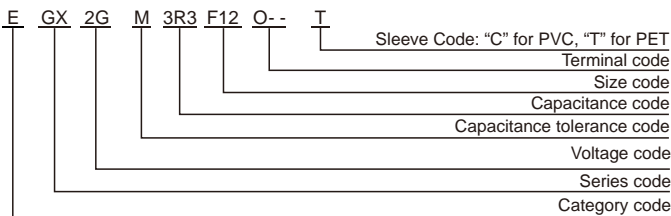

RATED RIPPLE CURRENT MULTIPLIERS

Frequency correction factor for ripple current

Cap.(μF)	Freq.(Hz)	120	1k	10k	100k
	Cap.<33	0.40	0.70	0.90	1.00
Cap. 33		0.50	0.80	0.90	1.00

CD11GES series

■ STANDARD RATINGS (Rated ripple current:mArms/105°C 100kHz)

WV (Vdc)	Cap (μF)	Size DxL(mm)	Rated ripple current	Part Number
160(2C)	1	6.3x9	40	EGX2CM010E09OT
	1.5	6.3x9	45	EGX2CM1R5E09OT
	1.8	6.3x9	50	EGX2CM1R8E09OT
	2.2	6.3x9	56	EGX2CM2R2E09OT
	2.8	6.3x9	70	EGX2CM2R8E09OT
	3.3	6.3x9	85	EGX2CM3R3E09OT
	4.7	6.3x12	96	EGX2CM4R7E12OT
	5.6	6.3x12	102	EGX2CM5R6E12OT
		8x9	102	EGX2CM5R6F09OT
	6.8	6.3x12	109	EGX2CM6R8E12OT
		8x9	109	EGX2CM6R8F09OT
	8.2	8x9	160	EGX2CM8R2F09OT
		8x12	172	EGX2CM8R2F12OT
	10	8x9	220	EGX2CM100F09OT
		8x12	255	EGX2CM100F12OT
	15	8x9	280	EGX2CM150F09OT
		8x12	300	EGX2CM150F12OT
	22	8x12	400	EGX2CM220F12OT
		10x12	440	EGX2CM220G12OT
	33	10x16	580	EGX2CM330G16OT
47	10x16	680	EGX2CM470G16OT	
68	12.5x20	1180	EGX2CM680W20OT	
100	12.5x20	1350	EGX2CM101W20OT	
150	16x20	1790	EGX2CM151L20OT	
220	16x25	2130	EGX2CM221L25OT	
200(2D)	1	6.3x9	55	EGX2DM010E09OT
	1.5	6.3x9	62	EGX2DM1R5E09OT
	1.8	6.3x9	66	EGX2DM1R8E09OT
	2.2	6.3x9	72	EGX2DM2R2E09OT
		6.3x12	81	EGX2DM2R2E12OT
	2.8	6.3x9	84	EGX2DM2R8E09OT
		6.3x12	95	EGX2DM2R8E12OT
	3.3	6.3x12	112	EGX2DM3R3E12OT
	4.7	8x9	144	EGX2DM4R7F09OT
		8x12	160	EGX2DM4R7F12OT
	5.6	8x9	170	EGX2DM5R6F09OT
		8x12	190	EGX2DM5R6F12OT
	6.8	8x9	190	EGX2DM6R8F09OT
		8x12	200	EGX2DM6R8F12OT
	8.2	8x12	279	EGX2DM8R2F12OT
	10	8x12	260	EGX2DM100F12OT
	15	10x12	330	EGX2DM150G12OT
	22	10x16	500	EGX2DM220G16OT
	33	10x20	650	EGX2DM330G20OT
	47	12.5x20	980	EGX2DM470W20OT
68	12.5x25	1300	EGX2DM680W25OT	
	16x20	1300	EGX2DM680L20OT	
82	16x20	1380	EGX2DM820L20OT	
100	16x20	1420	EGX2DM101L20OT	
	16x25	1494	EGX2DM101L25OT	
150	16x25	1890	EGX2DM151L25OT	
	16x30	1989	EGX2DM151L30OT	

WV (Vdc)	Cap (μF)	Size DxL(mm)	Rated ripple current	Part Number
250(2E)	1	6.3x9	55	EGX2EM010E09OT
	1.5	6.3x9	62	EGX2EM1R5E09OT
	1.8	6.3x9	66	EGX2EM1R8E09OT
	2.2	6.3x9	74	EGX2EM2R2E09OT
		6.3x12	81	EGX2EM2R2E12OT
	2.8	6.3x12	95	EGX2EM2R8E12OT
	3.3	6.3x12	112	EGX2EM3R3E12OT
	4.7	6.3x12	142	EGX2EM4R7E12OT
		8x12	160	EGX2EM4R7F12OT
	5.6	8x12	190	EGX2EM5R6F12OT
	6.8	8x12	200	EGX2EM6R8F12OT
	8.2	8x12	240	EGX2EM8R2F12OT
		8x12	295	EGX2EM100F12OT
	10	8x16	305	EGX2EM100F16OT
		8x16	400	EGX2EM150F16OT
15	10x12	360	EGX2EM150G12OT	
	10x16	500	EGX2EM220G16OT	
22	10x20	550	EGX2EM220G20OT	
	12.5x16	760	EGX2EM330W16OT	
33	12.5x20	800	EGX2EM330W20OT	
	12.5x20	980	EGX2EM470W20OT	
56	12.5x25	1080	EGX2EM560W25OT	
68	16x20	1270	EGX2EM680L20OT	
	16x25	1368	EGX2EM680L25OT	
82	16x25	1500	EGX2EM820L25OT	
	12.5x30	1500	EGX2EM820W30OT	
100	16x25	1580	EGX2EM101L25OT	
150	18x25	1800	EGX2EM151M25OT	
350(2V)	1	6.3x9	56	EGX2VM010E09OT
		6.3x12	64	EGX2VM010E12OT
	1.5	8x9	71	EGX2VM1R5F09OT
		8x12	75	EGX2VM1R5F12OT
	1.8	8x9	80	EGX2VM1R8F09OT
		8x12	85	EGX2VM1R8F12OT
	2.2	8x9	90	EGX2VM2R2F09OT
		8x12	95	EGX2VM2R2F12OT
	2.8	8x9	95	EGX2VM2R8F09OT
		8x12	100	EGX2VM2R8F12OT
	3.3	8x9	110	EGX2VM3R3F09OT
		8x12	118	EGX2VM3R3F12OT
	4.7	8x12	150	EGX2VM4R7F12OT
		8x16	170	EGX2VM4R7F16OT
	5.6	8x12	180	EGX2VM5R6F12OT
		8x16	200	EGX2VM5R6F16OT
	6.8	8x16	225	EGX2VM6R8F16OT
		10x12	225	EGX2VM6R8G12OT
	8.2	10x16	288	EGX2VM8R2G16OT
	10	8x20	320	EGX2VM100F20OT
10x16		330	EGX2VM100G16OT	
15	10x20	450	EGX2VM150G20OT	
22	12.5x20	650	EGX2VM220W20OT	
	12.5x20	855	EGX2VM330W20OT	
33	16x20	900	EGX2VM330L20OT	
	16x20	1080	EGX2VM470L20OT	
68	18x20	1368	EGX2VM680M20OT	
	18x25	1470	EGX2VM680M25OT	
82	18x25	1530	EGX2VM820M25OT	
	18x30	1700	EGX2VM101M30OT	

CD11GES series

■ STANDARD RATINGS (Rated ripple current:mArms/105°C 100kHz)

WV (Vdc)	Cap (μF)	Size DxL(mm)	Rated ripple current	Part Number
400(2G)	1	6.3x9	60	EGX2GM010E09OT
		6.3x12	65	EGX2GM010E12OT
	1.5	6.3x12	82	EGX2GM1R5E12OT
		8x9	82	EGX2GM1R5F09OT
	1.8	8x9	90	EGX2GM1R8F09OT
		8x12	95	EGX2GM1R8F12OT
	2.2	8x9	95	EGX2GM2R2F09OT
		8x12	100	EGX2GM2R2F12OT
	2.8	8x9	117	EGX2GM2R8F09OT
		8x12	130	EGX2GM2R8F12OT
	3.3	8x9	131	EGX2GM3R3F09OT
		8x12	140	EGX2GM3R3F12OT
	4.7	8x12	160	EGX2GM4R7F12OT
		10x12	170	EGX2GM4R7G12OT
	5.6	8x12	190	EGX2GM5R6F12OT
		10x12	202	EGX2GM5R6G12OT
	6.8	8x16	240	EGX2GM6R8F16OT
		10x16	265	EGX2GM6R8G16OT
	8.2	10x16	288	EGX2GM8R2G16OT
		10x16	310	EGX2GM100G16OT
	10	10x20	350	EGX2GM100G20OT
		15	12.5x20	550
	22	12.5x20	680	EGX2GM220W20OT
		12.5x25	760	EGX2GM220W25OT
		16x20	760	EGX2GM220L20OT
	33	16x20	900	EGX2GM330L20OT
		16x25	1125	EGX2GM330L25OT
	47	16x25	1140	EGX2GM470L25OT
		16x30	1180	EGX2GM470L30OT
	56	18x25	1476	EGX2GM560M25OT
68	18x30	1547	EGX2GM680M30OT	
100	18x35	1610	EGX2GM101M35OT	

WV (Vdc)	Cap (μF)	Size DxL(mm)	Rated ripple current	Part Number
450(2W)	1	6.3x12	80	EGX2WM010E12OT
	1.5	8x12	88	EGX2WM1R5F12OT
	1.8	8x12	90	EGX2WM1R8F12OT
	2.2	8x12	93	EGX2WM2R2F12OT
	2.8	8x16	119	EGX2WM2R8F16OT
	3.3	8x16	128	EGX2WM3R3F16OT
	4.7	10x16	180	EGX2WM4R7G16OT
	5.6	10x16	227	EGX2WM5R6G16OT
		10x20	250	EGX2WM5R6G20OT
	6.8	10x16	250	EGX2WM6R8G16OT
		10x20	265	EGX2WM6R8G20OT
	8.2	10x20	280	EGX2WM8R2G20OT
	10	10x20	300	EGX2WM100G20OT
	15	12.5x20	450	EGX2WM150W20OT
	22	12.5x25	600	EGX2WM220W25OT
		16x20	730	EGX2WM220L20OT
	33	16x25	980	EGX2WM330L25OT
	47	16x35	1080	EGX2WM470L35OT
		18x25	1200	EGX2WM470M25OT
	56	18x30	1429	EGX2WM560M30OT
68	18x35	1500	EGX2WM680M35OT	
100	18x45	1666	EGX2WM101M45OT	
500(2H)	10	12.5x20	320	EGX2HM100W20OT
		12.5x25	336	EGX2HM100W25OT
	15	12.5x25	440	EGX2HM150W25OT
		16x20	440	EGX2HM150L20OT
	22	12.5x35	560	EGX2HM220W35OT
		16x25	560	EGX2HM220L25OT
	33	18x25	700	EGX2HM330M25OT
	47	18x30	880	EGX2HM470M30OT
	68	22x35	1100	EGX2HM680O35OT
	82	22x35	1255	EGX2HM820O35OT
100	22x35	1500	EGX2HM101O35OT	

CD11GK series

- Endurance: +105 °C 12,000~20,000 hours
- Extremely miniaturized, high ripple current
- Suitable for output circuit and input circuit of LED driving power.
- **RoHS Compliant**



SPECIFICATIONS

Items	Characteristics							
Category Temperature Range	-40~+105°C(160~ 450 V _{dc})							
Rated Voltage Range	160~450 V _{dc}							
Capacitance Tolerance	±20%(M) (at 20°C, 120Hz)							
Leakage Current	160~400 V _{dc}	450 V _{dc}		Where, I: Max.leakage current (µA), C:Nominal capacitance (µF), V: Rated voltage (V)				(at 20°C after 2 minutes)
	I 0.03CV+15µA	I 0.03CV+25µA						
Dissipation Factor (tan δ)	Rated Voltage(V _{dc})	160	200	250	350	400	450	(at 20°C, 120Hz)
	tan δ (max.)	0.24	0.24	0.24	0.24	0.24	0.24	
Low Temperature Characteristics (Max. Impedance Ratio)	Rated Voltage(V _{dc})	160	200	250	350	400	450	(at 120Hz)
	Z(-25°C)/Z(+20°C)	3	3	3	5	5	8	
	Z(-40°C)/Z(+20°C)	8	8	8	8	8	12	
Endurance	The specifications listed below shall be met when the capacitors are restored to 20 °C after DC voltage plus rated ripple current is applied for a specified period of time at 105°C, the peak voltage shall not exceed the rated voltage.							
	Capacitance Change	±30% of the initial value					Size(mm)	Load life (hours)
	D.F. (tan δ)	300% of the initial specified value					6.3×9 6.3×12 8×9 10×9	12,000
	Leakage Current	The initial specified value					8×12 8×16 8×20 10×12	15,000
Shelf Life	The following specifications shall be satisfied when the capacitors are restored to 20°C after leaving them under no load at 105°C for 1,000 hours.							
	Capacitance Change	±20% of the initial value					10×16	20,000
	D.F. (tan δ)	200% of the initial specified value						
	Leakage Current	200% of the initial specified value						

DIMENSIONS[mm]

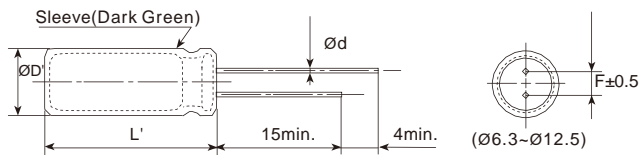

ØD	6.3	8	10	12.5
Ød	0.5	0.5	0.6	0.6
F	2.5	3.5	5.0	5.0
ØD'	ØD+0.5max.			
L'	L+2max.			

PART NUMBERING SYSTEM

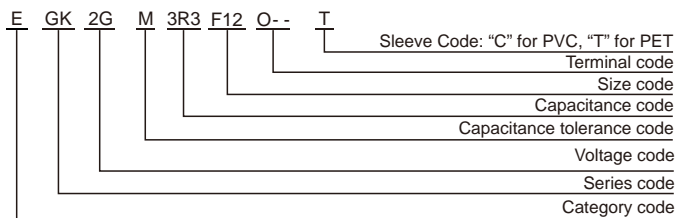

RATED RIPPLE CURRENT MULTIPLIERS

Frequency correction factor for ripple current

Freq.(Hz)	120	1k	10k	100k
Rated voltage(V _{dc})	0.50	0.80	0.90	1.00

CD11GK series

■ STANDARD RATINGS (Rated ripple current:mArms/105°C 100kHz)

WV (Vdc)	Cap (μF)	Size DxL (mm)	Rated ripple current	Part Number
160(2C)	1	6.3x9	50	EGK2CM010E09OT
	1.5	6.3x9	62	EGK2CM1R5E09OT
	1.8	6.3x9	72	EGK2CM1R8E09OT
	2.2	6.3x9	76	EGK2CM2R2E09OT
	2.8	6.3x12	80	EGK2CM2R8E12OT
	3.3	6.3x12	92	EGK2CM3R3E12OT
	4.7	6.3x12	104	EGK2CM4R7E12OT
	5.6	6.3x12	110	EGK2CM5R6E12OT
	6.8	6.3x12	124	EGK2CM6R8E12OT
	8.2	8x9	135	EGK2CM8R2F09OT
	10	8x9	150	EGK2CM100F09OT
	15	8x12	190	EGK2CM150F12OT
		10x9	210	EGK2CM150G09OT
		10x12	250	EGK2CM220G12OT
		33	10x16	412
47	10x20	525	EGK2CM470G20OT	
200(2D)	1	6.3x9	52	EGK2DM010E09OT
	1.5	6.3x9	60	EGK2DM1R5E09OT
	1.8	6.3x9	64	EGK2DM1R8E09OT
	2.2	6.3x12	72	EGK2DM2R2E12OT
	2.8	6.3x12	84	EGK2DM2R8E12OT
	3.3	6.3x12	88	EGK2DM3R3E12OT
	4.7	6.3x12	102	EGK2DM4R7E12OT
	5.6	8x9	116	EGK2DM5R6F09OT
	6.8	8x9	128	EGK2DM6R8F09OT
	8.2	8x9	144	EGK2DM8R2F09OT
	10	8x12	160	EGK2DM100F12OT
	12	10x9	180	EGK2DM120G09OT
	15	8x16	240	EGK2DM150F16OT
		10x12	280	EGK2DM150G12OT
		22	10x16	340
33		10x20	550	EGK2DM330G20OT
47	12.5x20	750	EGK2DM470W20OT	
250(2E)	1	6.3x9	52	EGK2EM010E09OT
	1.5	6.3x9	60	EGK2EM1R5E09OT
	1.8	6.3x12	64	EGK2EM1R8E12OT
	2.2	6.3x12	72	EGK2EM2R2E12OT
	2.8	6.3x12	88	EGK2EM2R8E12OT
	3.3	6.3x12	92	EGK2EM3R3E12OT
	4.7	6.3x12	120	EGK2EM4R7E12OT
		8x9	125	EGK2EM4R7F09OT
	5.6	8x9	132	EGK2EM5R6F09OT
	6.8	8x9	160	EGK2EM6R8F09OT
	8.2	8x9	172	EGK2EM8R2F09OT
	10	8x12	200	EGK2EM100F12OT
	15	10x12	270	EGK2EM150G12OT
	22	10x16	370	EGK2EM220G16OT
	33	10x20	562	EGK2EM330G20OT
47	12.5x20	788	EGK2EM470W20OT	

WV (Vdc)	Cap (μF)	Size DxL (mm)	Rated ripple current	Part Number
350(2V)	1	6.3x9	56	EGK2VM010E09OT
	1.5	6.3x12	66	EGK2VM1R5E12OT
	1.8	6.3x12	72	EGK2VM1R8E12OT
	2.2	8x9	80	EGK2VM2R2F09OT
		8x12	85	EGK2VM2R2F12OT
	2.8	8x12	92	EGK2VM2R8F12OT
	3.3	8x12	100	EGK2VM3R3F12OT
		10x9	120	EGK2VM3R3G09OT
	4.7	8x12	128	EGK2VM4R7F12OT
	5.6	8x16	136	EGK2VM5R6F16OT
	6.8	10x12	168	EGK2VM6R8G12OT
	8.2	10x16	180	EGK2VM8R2G16OT
	10	10x16	210	EGK2VM100G16OT
	15	10x20	290	EGK2VM150G20OT
	400(2G)	1	6.3x12	54
1.2		8x9	60	EGK2GM1R2F09OT
1.5		8x9	66	EGK2GM1R5F09OT
1.8		8x9	72	EGK2GM1R8F09OT
2.2		8x9	76	EGK2GM2R2F09OT
		8x12	82	EGK2GM2R2F12OT
2.8		8x12	88	EGK2GM2R8F12OT
3.3		8x12	100	EGK2GM3R3F12OT
		10x9	110	EGK2GM3R3G09OT
4.7		10x12	126	EGK2GM4R7G12OT
5.6		8x20	156	EGK2GM5R6F20OT
		10x12	158	EGK2GM5R6G12OT
6.8		8x20	170	EGK2GM6R8F20OT
		10x16	180	EGK2GM6R8G16OT
8.2		10x16	190	EGK2GM8R2G16OT
10	10x16	224	EGK2GM100G16OT	
15	12.5x20	300	EGK2GM150W20OT	
450(2W)	1	6.3x12	54	EGK2WM010E12OT
	1.5	8x12	70	EGK2WM1R5F12OT
	1.8	8x12	80	EGK2WM1R8F12OT
	2.2	8x12	88	EGK2WM2R2F12OT
	2.8	8x16	100	EGK2WM2R8F16OT
	3.3	8x16	110	EGK2WM3R3F16OT
	4.7	10x12	140	EGK2WM4R7G12OT
	5.6	10x16	180	EGK2WM5R6G16OT
	6.8	10x16	200	EGK2WM6R8G16OT
	8.2	10x20	238	EGK2WM8R2G20OT
10	10x20	284	EGK2WM100G20OT	

CD11GN series

- Endurance: +130°C 1,000~2,000 hours; +105°C 8,000~12,000 hours
- Withstand high temperature, miniaturized, long life
- Suitable for output circuit and input circuit of LED driving power.
- **RoHS Compliant**

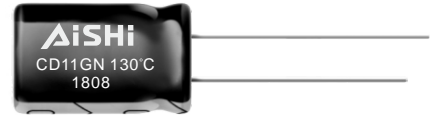

SPECIFICATIONS

Items	Characteristics							
Category Temperature Range	-40~+130°C(160~ 450 V _{dc})				-40~+105°C(500 V _{dc})			
Rated Voltage Range	160~500 V _{dc}							
Capacitance Tolerance	±20%(M) (at 20°C, 120Hz)							
Leakage Current	160~400 V _{dc}	450~500 V _{dc}		Where, I: Max.leakage current (μA), C: Nominal capacitance (μF), V: Rated voltage (V)				
	I 0.02CV+10μA	I 0.03CV+10μA		(at 20°C after 2 minutes)				
Dissipation Factor (tan δ)	Rated Voltage(V _{dc})	160	200	250	350	400	450	500
	tan δ (max.)	0.15	0.15	0.15	0.20	0.20	0.20	0.24
Low Temperature Characteristics (Max. Impedance Ratio)	Rated Voltage(V _{dc})	160	200	250	350	400	450	500
	Z(-25°C)/Z(+20°C)	3	3	3	5	5	6	6
	Z(-40°C)/Z(+20°C)	6	6	6	6	6	9	15
Endurance	The specifications listed below shall be met when the capacitors are restored to 20°C after DC voltage plus rated ripple current is applied for a specified period of time at 130°C or 105°C, the peak voltage shall not exceed the rated voltage.							
	Capacitance Change	±20% of the initial value			Case Dia. (mm)	130°C Load life (hours)	105°C Load life (hours)	
	D.F. (tan δ)	200% of the initial specified value			ØD=6.3	160~450WV	160~450WV	500WV
	Leakage Current	The initial specified value			ØD 8	1,000	8,000	10,000
Shelf Life	The following specifications shall be satisfied when the capacitors are restored to 20°C after leaving them under no load at 105°C for 1,000 hours.							
	Capacitance Change	±20% of the initial value						
	D.F. (tan δ)	200% of the initial specified value						
	Leakage Current	200% of the initial specified value						

DIMENSIONS[mm]

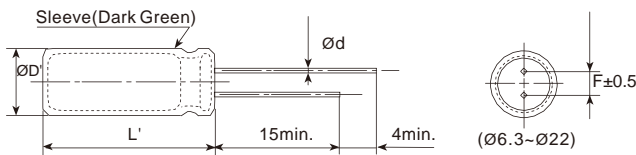

ØD	6.3	8	10	12.5	16	18	22
Ød	0.5	0.5	0.6	0.6	0.8	0.8	0.8
F	2.5	3.5	5.0	5.0	7.5	7.5	10
ØD'	ØD+0.5max.						
L'	L+2max.						

PART NUMBERING SYSTEM

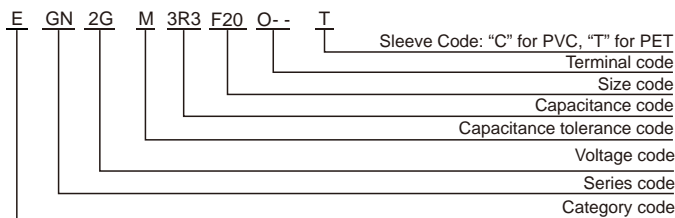

RATED RIPPLE CURRENT MULTIPLIERS

Frequency correction factor for ripple current

Cap.(μF)	Freq.(Hz)	120	1k	10k	100k
	Cap.<33	0.40	0.70	0.90	1.00
Cap. 33		0.50	0.80	0.90	1.00

CD11GN series

■ STANDARD RATINGS (Rated ripple current: mA rms/105°C 100kHz or mA rms/130°C 100kHz)

WV (Vdc)	Cap (µF)	Size D×L(mm)	Rated ripple current (105°C)	Rated ripple current (130°C)	Part Number
160 (2C)	1	6.3×7	40	26	EGN2CM010E07OT
		6.3×9	45	30	EGN2CM010E09OT
	1.5	6.3×7	46	31	EGN2CM1R5E07OT
		6.3×9	50	34	EGN2CM1R5E09OT
	1.8	6.3×7	53	35	EGN2CM1R8E07OT
		6.3×9	58	38	EGN2CM1R8E09OT
	2.2	6.3×7	58	38	EGN2CM2R2E07OT
		6.3×9	64	42	EGN2CM2R2E09OT
	2.8	6.3×7	61	40	EGN2CM2R8E07OT
		6.3×9	68	45	EGN2CM2R8E09OT
	3.3	6.3×9	72	47	EGN2CM3R3E09OT
	4.7	6.3×9	76	49	EGN2CM4R7E09OT
		8×9	82	54	EGN2CM4R7F09OT
	5.6	8×9	88	58	EGN2CM5R6F09OT
	6.8	8×9	100	65	EGN2CM6R8F09OT
		8×9	170	110	EGN2CM100F09OT
	10	8×12	190	124	EGN2CM100F12OT
		8×9	230	150	EGN2CM150F09OT
	15	8×12	255	165	EGN2CM150F12OT
		8×12	340	221	EGN2CM220F12OT
	22	10×12	420	273	EGN2CM220G12OT
		10×16	520	340	EGN2CM330G16OT
	47	10×16	570	371	EGN2CM470G16OT
		10×20	595	387	EGN2CM470G20OT
68	10×20	680	442	EGN2CM680G20OT	
	12.5×16	680	442	EGN2CM680W16OT	
100	12.5×20	1100	715	EGN2CM101W20OT	
	12.5×25	1120	728	EGN2CM101W25OT	
150	12.5×25	1200	780	EGN2CM151W25OT	
	16×20	1200	780	EGN2CM151L20OT	
220	16×25	1400	910	EGN2CM221L25OT	
330	18×30	1655	1075	EGN2CM331M30OT	
200 (2D)	1	6.3×7	46	31	EGN2DM010E07OT
		6.3×9	52	40	EGN2DM010E09OT
	1.5	6.3×7	52	40	EGN2DM1R5E07OT
		6.3×9	56	42	EGN2DM1R5E09OT
	1.8	6.3×7	56	40	EGN2DM1R8E07OT
		6.3×9	60	45	EGN2DM1R8E09OT
	2.2	6.3×9	68	50	EGN2DM2R2E09OT
		6.3×12	74	55	EGN2DM2R2E12OT
	2.8	6.3×9	74	55	EGN2DM2R8E09OT
		6.3×12	80	60	EGN2DM2R8E12OT
	3.3	6.3×9	86	65	EGN2DM3R3E09OT
		6.3×12	96	72	EGN2DM3R3E12OT
	4.7	6.3×12	128	102	EGN2DM4R7E12OT
		8×9	135	107	EGN2DM4R7F09OT
	5.6	8×12	154	122	EGN2DM4R7F12OT
		8×9	150	120	EGN2DM5R6F09OT
	6.8	8×12	165	132	EGN2DM5R6F12OT
		8×9	158	125	EGN2DM6R8F09OT
	8.2	8×12	175	140	EGN2DM6R8F12OT
		8×9	180	144	EGN2DM8R2F09OT
	10	8×12	195	150	EGN2DM8R2F12OT
		8×9	210	158	EGN2DM100F09OT
	15	8×12	240	168	EGN2DM100F12OT
		8×12	325	228	EGN2DM150F12OT
	22	8×16	338	235	EGN2DM150F16OT
		8×20	382	248	EGN2DM220F20OT
	22	10×16	446	290	EGN2DM220G16OT
		10×20	492	320	EGN2DM220G20OT

WV (Vdc)	Cap (µF)	Size D×L(mm)	Rated ripple current (105°C)	Rated ripple current (130°C)	Part Number	
200 (2D)	33	10×20	570	370	EGN2DM330G20OT	
		12.5×16	570	370	EGN2DM330W16OT	
		12.5×20	600	390	EGN2DM330W20OT	
	47	12.5×16	600	390	EGN2DM470W16OT	
		12.5×20	628	408	EGN2DM470W20OT	
		12.5×25	660	430	EGN2DM470W25OT	
	68	12.5×25	760	494	EGN2DM680W25OT	
		16×20	800	520	EGN2DM680L20OT	
		16×20	880	572	EGN2DM820L20OT	
	82	12.5×30	1010	657	EGN2DM101W30OT	
		16×25	1060	690	EGN2DM101L25OT	
	100	12.5×40	1120	728	EGN2DM151W40OT	
		16×30	1220	793	EGN2DM151L30OT	
	250 (2E)	1	6.3×7	46	31	EGN2EM010E07OT
			6.3×9	52	40	EGN2EM010E09OT
		1.5	6.3×7	52	40	EGN2EM1R5E07OT
			6.3×9	56	42	EGN2EM1R5E09OT
		1.8	6.3×7	56	40	EGN2EM1R8E07OT
6.3×9			60	45	EGN2EM1R8E09OT	
2.2		6.3×9	68	50	EGN2EM2R2E09OT	
		6.3×12	74	55	EGN2EM2R2E12OT	
2.8		6.3×9	74	55	EGN2EM2R8E09OT	
		6.3×12	80	60	EGN2EM2R8E12OT	
3.3		6.3×9	86	65	EGN2EM3R3E09OT	
		6.3×12	100	74	EGN2EM3R3E12OT	
4.7		8×9	120	95	EGN2EM4R7F09OT	
		8×12	154	122	EGN2EM4R7F12OT	
5.6		8×9	150	120	EGN2EM5R6F09OT	
		8×12	165	132	EGN2EM5R6F12OT	
6.8		8×9	158	125	EGN2EM6R8F09OT	
		8×12	216	162	EGN2EM6R8F12OT	
8.2	8×12	245	180	EGN2EM8R2F12OT		
	8×16	274	192	EGN2EM8R2F16OT		
	10×9	235	172	EGN2EM8R2G09OT		
10	8×12	265	185	EGN2EM100F12OT		
	8×16	294	205	EGN2EM100F16OT		
15	8×16	340	221	EGN2EM150F16OT		
	8×20	378	245	EGN2EM150F20OT		
22	10×16	462	300	EGN2EM220G16OT		
	12.5×16	550	358	EGN2EM330W16OT		
33	12.5×20	610	398	EGN2EM330W20OT		
	12.5×16	610	398	EGN2EM470W16OT		
47	12.5×20	648	420	EGN2EM470W20OT		
	12.5×25	805	523	EGN2EM680W25OT		
68	16×20	830	540	EGN2EM680L20OT		
	12.5×35	966	628	EGN2EM101W35OT		
100	16×25	1030	668	EGN2EM101L25OT		
	12.5×50	1288	838	EGN2EM151W50OT		
150	16×35	1400	910	EGN2EM151L35OT		
	18×25	1330	865	EGN2EM151M25OT		

Radial Type

CD11GN series

■ STANDARD RATINGS (Rated ripple current: mA rms/105°C 100kHz or mA rms/130°C 100kHz)

WV (Vdc)	Cap (μF)	Size D×L(mm)	Rated ripple current (105°C)	Rated ripple current (130°C)	Part Number
350 (2V)	1	6.3x9	52	40	EGN2VM010E09OT
	1.5	6.3x12	65	50	EGN2VM1R5E12OT
		8x9	68	52	EGN2VM1R5F09OT
	1.8	6.3x12	70	54	EGN2VM1R8E12OT
		8x9	74	57	EGN2VM1R8F09OT
	2.2	6.3x12	78	60	EGN2VM2R2E12OT
		8x9	82	63	EGN2VM2R2F09OT
	2.8	8x9	86	65	EGN2VM2R8F09OT
		8x12	90	68	EGN2VM2R8F12OT
	3.3	8x9	95	71	EGN2VM3R3F09OT
		8x12	100	75	EGN2VM3R3F12OT
	4.7	8x12	135	108	EGN2VM4R7F12OT
	5.6	8x12	140	109	EGN2VM5R6F12OT
		8x16	160	125	EGN2VM5R6F16OT
	6.8	8x16	170	123	EGN2VM6R8F16OT
		8x20	195	142	EGN2VM6R8F20OT
	8.2	8x20	250	164	EGN2VM8R2F20OT
	10	10x16	275	178	EGN2VM100G16OT
		10x20	300	195	EGN2VM100G20OT
	15	10x20	380	247	EGN2VM150G20OT
22	12.5x20	476	309	EGN2VM220W20OT	
33	16x20	600	390	EGN2VM330L20OT	
47	16x20	740	480	EGN2VM470L20OT	
68	18x25	880	572	EGN2VM680M25OT	
100	18x30	1160	754	EGN2VM101M30OT	
400 (2G)	1	6.3x9	62	55	EGN2GM010E09OT
		6.3x12	66	60	EGN2GM010E12OT
	1.2	6.3x12	68	62	EGN2GM1R2E12OT
	1.5	8x9	75	68	EGN2GM1R5F09OT
		8x12	86	75	EGN2GM1R5F12OT
	1.8	8x9	80	70	EGN2GM1R8F09OT
		8x12	90	78	EGN2GM1R8F12OT
	2.2	6.3x12	87	72	EGN2GM2R2E12OT
		8x12	92	80	EGN2GM2R2F12OT
	2.8	8x12	108	85	EGN2GM2R8F12OT
		8x16	120	96	EGN2GM2R8F16OT
	3.3	8x12	120	96	EGN2GM3R3F12OT
		8x16	128	102	EGN2GM3R3F16OT
	4.7	8x12	148	110	EGN2GM4R7F12OT
		8x16	158	120	EGN2GM4R7F16OT
	5.6	8x12	153	116	EGN2GM5R6F12OT
		10x12	162	122	EGN2GM5R6G12OT
	5.6	10x16	180	135	EGN2GM5R6G16OT
		8x20	202	142	EGN2GM6R8F20OT
	6.8	10x16	210	148	EGN2GM6R8G16OT
		10x16	252	164	EGN2GM8R2G16OT
	8.2	10x20	266	174	EGN2GM8R2G20OT
		10x16	288	187	EGN2GM100G16OT
	10	10x20	304	198	EGN2GM100G20OT
		8x40	340	220	EGN2GM150F40OT
	15	12.5x16	360	234	EGN2GM150W16OT
		12.5x20	400	260	EGN2GM150W20OT
	22	8x50	476	310	EGN2GM220F50OT
		12.5x20	490	318	EGN2GM220W20OT
	22	12.5x25	532	346	EGN2GM220W25OT
		10x45	627	408	EGN2GM330G45OT
	33	16x20	560	364	EGN2GM330L20OT

WV (Vdc)	Cap (μF)	Size D×L(mm)	Rated ripple current (105°C)	Rated ripple current (130°C)	Part Number
400 (2G)	47	12.5x40	660	429	EGN2GM470W40OT
		16x25	700	455	EGN2GM470L25OT
	68	12.5x55	870	566	EGN2GM680W55OT
		18x25	835	543	EGN2GM680M25OT
		18x35	1090	708	EGN2GM101M35OT
450 (2W)	1	8x9	64	56	EGN2WM010F09OT
		8x12	68	62	EGN2WM010F12OT
	1.5	8x12	84	74	EGN2WM1R5F12OT
		10x9	90	76	EGN2WM1R5G09OT
	1.8	8x12	90	76	EGN2WM1R8F12OT
		10x9	95	80	EGN2WM1R8G09OT
	2.2	8x16	92	78	EGN2WM2R2F16OT
	2.8	8x16	120	96	EGN2WM2R8F16OT
	3.3	8x16	125	100	EGN2WM3R3F16OT
	4.7	8x20	168	125	EGN2WM4R7F20OT
500 (2H)	5.6	10x12	150	110	EGN2WM4R7G12OT
		10x16	180	135	EGN2WM5R6G16OT
	6.8	10x16	200	132	EGN2WM6R8G16OT
		10x20	220	154	EGN2WM6R8G20OT
	8.2	10x16	235	153	EGN2WM8R2G16OT
		10x20	266	174	EGN2WM8R2G20OT
	10	10x25	304	198	EGN2WM100G25OT
		12.5x16	290	188	EGN2WM100W16OT
	15	8x45	400	260	EGN2WM150F45OT
		12.5x20	400	260	EGN2WM150W20OT
	22	10x40	500	325	EGN2WM220G40OT
		16x20	500	325	EGN2WM220L20OT
		10x50	615	400	EGN2WM330G50OT
	33	16x25	665	432	EGN2WM330L25OT
		12.5x45	720	468	EGN2WM470W45OT
47	16x35	818	532	EGN2WM470L35OT	
	18x30	900	585	EGN2WM680M30OT	
68	18x35	1110	722	EGN2WM101M35OT	
	18x40	1180	768	EGN2WM101M40OT	
500 (2H)	10	12.5x20	288	/	EGN2HM100W20OT
		12.5x25	302	/	EGN2HM100W25OT
	15	12.5x25	396	/	EGN2HM150W25OT
		16x20	396	/	EGN2HM150L20OT
	22	12.5x35	504	/	EGN2HM220W35OT
		16x25	504	/	EGN2HM220L25OT
	33	18x25	630	/	EGN2HM330M25OT
	47	18x30	792	/	EGN2HM470M30OT
	68	22x35	1100	/	EGN2HM680O35OT
	82	22x35	1200	/	EGN2HM820O35OT
100	22x35	1480	/	EGN2HM101O35OT	

CD11GZ series

- Endurance: +105°C 12,000 hours
- Suitable for outdoor lighting; long life
- RoHS Compliant

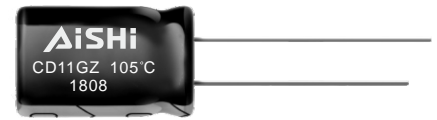

SPECIFICATIONS

Items	Characteristics						
Category Temperature Range	-40~+105°C (250~ 500 V _{dc})						
Rated Voltage Range	250~500 V _{dc}						
Capacitance Tolerance	±20%(M) (at 20°C, 120Hz)						
Leakage Current	250~400 V _{dc}	450~500 V _{dc}		Where, I: Max.leakage current (μA), C:Nominal capacitance (μF), V: Rated voltage (V)			
	I 0.02CV+10μA	I 0.03CV+10μA		(at 20°C after 2 minutes)			
Dissipation Factor (tan δ)	Rated Voltage(V _{dc})	250	350	400	450	500	(at 20°C, 120Hz)
	tan δ (max.)	0.15	0.20	0.20	0.20	0.24	
Low Temperature Characteristics (Max. Impedance Ratio)	Rated Voltage(V _{dc})	250	350	400	450	500	(at 120Hz)
	Z(-25°C)/Z(+20°C)	3	3	3	3	3	
	Z(-40°C)/Z(+20°C)	4	4	4	4	4	
Endurance	The specifications listed below shall be met when the capacitors are restored to 20°C after DC voltage plus rated ripple current is applied for 12,000 hours at 105°C (WV: 500V for 10,000 hours), the peak voltage shall not exceed the rated voltage.						
	Capacitance Change	±20% of the initial value					
	D.F. (tan δ)	200% of the initial specified value					
	Leakage Current	The initial specified value					
Shelf Life	The following specifications shall be satisfied when the capacitors are restored to 20°C after leaving them under no load at 105°C for 1,000 hours.						
	Capacitance Change	±20% of the initial value					
	D.F. (tan δ)	200% of the initial specified value					
	Leakage Current	200% of the initial specified value					

DIMENSIONS[mm]

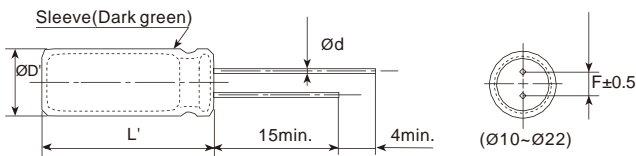

ØD	10	12.5	16	18	22
Ød	0.6	0.6	0.8	0.8	0.8
F	5.0	5.0	7.5	7.5	10
ØD'	ØD+0.5max.				
L'	L+2max.				

PART NUMBERING SYSTEM

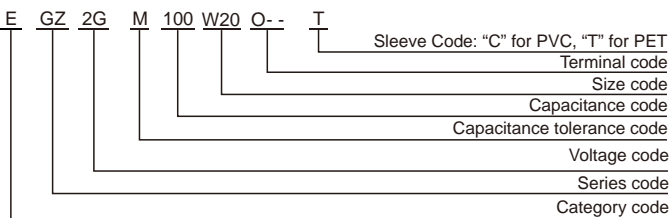

RATED RIPPLE CURRENT MULTIPLIERS

Frequency correction factor for ripple current

Cap.(μF) \ Freq.(Hz)	120	1k	10k	100k
Cap.<33	0.40	0.70	0.90	1.00
Cap. 33	0.50	0.80	0.90	1.00

CD11GZ series

■ STANDARD RATINGS (Rated ripple current: mA rms/105°C 100kHz)

WV (Vdc)	Cap (μF)	Size DxL (mm)	Rated ripple current	Part Number
250(2E)	10	10x16	320	EGZ2EM100G16OT
	15	10x20	420	EGZ2EM150G20OT
	22	12.5x16	550	EGZ2EM220W16OT
	33	12.5x20	800	EGZ2EM330W20OT
	47	12.5x25	980	EGZ2EM470W25OT
	68	16x25	1368	EGZ2EM680L25OT
	82	16x25	1500	EGZ2EM820L25OT
	100	16x30	1610	EGZ2EM101L30OT
	150	18x35	2000	EGZ2EM151M35OT
350(2V)	10	10x20	350	EGZ2VM100G20OT
	15	12.5x20	450	EGZ2VM150W20OT
	22	12.5x20	650	EGZ2VM220W20OT
	33	16x20	900	EGZ2VM330L20OT
	47	16x25	1080	EGZ2VM470L25OT
	68	18x25	1470	EGZ2VM680M25OT
	82	18x30	1530	EGZ2VM820M30OT
	100	18x35	1700	EGZ2VM101M35OT
	150	18x45	1860	EGZ2VM151M45OT
400(2G)	10	12.5x20	350	EGZ2GM100W20OT
	15	12.5x25	550	EGZ2GM150W25OT
	22	16x20	760	EGZ2GM220L20OT
	33	16x30	1125	EGZ2GM330L30OT
	47	18x30	1180	EGZ2GM470M30OT
	68	18x30	1547	EGZ2GM680M30OT
	82	18x35	1620	EGZ2GM820M35OT
	100	18x40	1718	EGZ2GM101M40OT
	120	22x35	1820	EGZ2GM121O35OT
	150	22x40	1880	EGZ2GM151O40OT

WV (Vdc)	Cap (μF)	Size DxL (mm)	Rated ripple current	Part Number
450(2W)	10	12.5x20	330	EGZ2WM100W20OT
	15	12.5x25	450	EGZ2WM150W25OT
	22	16x20	730	EGZ2WM220L20OT
	33	16x30	980	EGZ2WM330L30OT
	47	18x30	1200	EGZ2WM470M30OT
	68	18x35	1500	EGZ2WM680M35OT
	82	18x35	1560	EGZ2WM820M35OT
	100	18x45	1666	EGZ2WM101M45OT
	120	22x40	1780	EGZ2WM121O40OT
	150	22x46	1820	EGZ2WM151O46OT
500(2H)	10	12.5x20	320	EGZ2HM100W20OT
	15	12.5x25	440	EGZ2HM150W25OT
	22	16x25	560	EGZ2HM220L25OT
	33	18x25	700	EGZ2HM330M25OT
	47	18x30	880	EGZ2HM470M30OT
	68	22x35	1350	EGZ2HM680O35OT
	82	22x35	1420	EGZ2HM820O35OT
	100	22x35	1460	EGZ2HM101O35OT
	120	22x40	1560	EGZ2HM121O40OT
	150	22x46	1630	EGZ2HM151O46OT

CD11GAS series

- Miniaturized, long life
- Endurance: +105°C 8,000~10,000 hours
- RoHS Compliant

Upgrade



SPECIFICATIONS

Items	Characteristics										
Category Temperature Range	-40~+105°C										
Rated Voltage Range	140~500 V _{dc}										
Capacitance Tolerance	±20%(M) (at 20°C, 120Hz)										
Leakage Current	140~400 V _{dc}	450~500 V _{dc}		Where, I: Max.leakage current (μA), C:Nominal capacitance (μF), V: Rated voltage (V) (at 20°C after 2 minutes)							
	I 0.02CV+10μA	I 0.03CV+10μA									
Dissipation Factor (tan δ)	Rated Voltage(V _{dc})	140	160	200	250	315	350	400	450	500	(at 20°C, 120Hz)
	tan δ (max.)	0.15	0.15	0.15	0.15	0.20	0.20	0.20	0.20	0.24	
Low Temperature Characteristics (Max. Impedance Ratio)	Rated Voltage(V _{dc})	140	160	200	250	315	350	400	450	500	(at 120Hz)
	Z(-25°C)/Z(+20°C)	3	3	3	3	5	5	5	6	6	
	Z(-40°C)/Z(+20°C)	6	6	6	6	6	6	6	9	15	
Endurance	The specifications listed below shall be met when the capacitors are restored to 20°C after DC voltage plus the rated ripple current is applied for 10,000 hours at 105°C (WV:500V for 8,000 hours), the peak voltage shall not exceed the rated voltage.										
	Capacitance Change	±20% of the initial value									
	D.F. (tan δ)	200% of the initial specified value									
	Leakage Current	The initial specified value									
Shelf Life	The following specifications shall be satisfied when the capacitors are restored to 20°C after leaving them under no load at 105°C for 1,000 hours.										
	Capacitance Change	±20% of the initial value									
	D.F. (tan δ)	200% of the initial specified value									
	Leakage Current	200% of the initial specified value									

DIMENSIONS[mm]

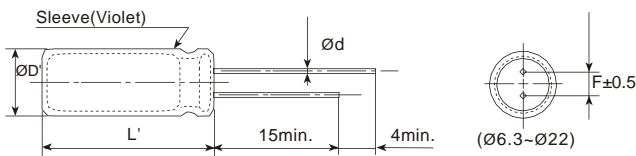

ØD	6.3	8	10	12.5	16	18	22
Ød	0.5	0.5	0.6	0.6	0.6	0.8	0.8
F	2.5	3.5	5.0	5.0	7.5	7.5	10
ØD'	ØD+0.5max.						
L'	L+2max.						

PART NUMBERING SYSTEM

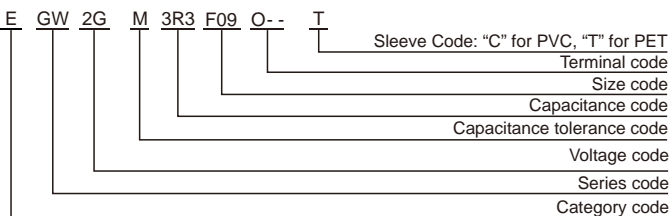

RATED RIPPLE CURRENT MULTIPLIERS

Frequency correction factor for ripple current

Freq.(Hz)	120	1k	10k	100k
Rated voltage(V _{dc})	0.50	0.80	0.90	1.00

CD11GAS series

■ STANDARD RATINGS (Rated ripple current: mArms/105°C 100kHz)

WV (Vdc)	Cap (μF)	Size D×L(mm)	Rated ripple current	Part Number
140(2A)	10	6.3×12	115	EGW2AM100E12OT
	15	6.3×12	145	EGW2AM150E12OT
	22	8×12	270	EGW2AM220F12OT
	33	10×12	380	EGW2AM330G12OT
	47	8×20	480	EGW2AM470F20OT
	68	10×20	570	EGW2AM680G20OT
	100	12.5×16	710	EGW2AM101W16OT
	150	12.5×25	980	EGW2AM151W25OT
220	16×20	1320	EGW2AM221L20OT	
160(2C)	1	6.3×7	36	EGW2CM010E07OT
		6.3×9	40	EGW2CM010E09OT
	1.5	6.3×7	40	EGW2CM1R5E07OT
		6.3×9	45	EGW2CM1R5E09OT
	1.8	6.3×7	45	EGW2CM1R8E07OT
		6.3×9	50	EGW2CM1R8E09OT
	2.2	6.3×7	50	EGW2CM2R2E07OT
		6.3×9	55	EGW2CM2R2E09OT
	2.8	6.3×9	70	EGW2CM2R8E09OT
		6.3×12	78	EGW2CM2R8E12OT
	3.3	6.3×9	85	EGW2CM3R3E09OT
		6.3×12	92	EGW2CM3R3E12OT
	4.7	6.3×9	92	EGW2CM4R7E09OT
		6.3×12	97	EGW2CM4R7E12OT
	5.6	6.3×9	96	EGW2CM5R6E09OT
		6.3×12	100	EGW2CM5R6E12OT
	6.8	6.3×9	100	EGW2CM6R8E09OT
		6.3×12	107	EGW2CM6R8E12OT
	8.2	8×9	107	EGW2CM6R8F09OT
		6.3×12	150	EGW2CM8R2E12OT
	10	8×9	150	EGW2CM8R2F09OT
		8×9	190	EGW2CM100F09OT
	15	8×12	240	EGW2CM100F12OT
		8×9	270	EGW2CM150F09OT
	22	8×12	290	EGW2CM150F12OT
		8×12	390	EGW2CM220F12OT
	33	10×12	430	EGW2CM220G12OT
		10×16	520	EGW2CM330G16OT
	47	10×16	680	EGW2CM470G16OT
		10×20	800	EGW2CM560G20OT
	68	10×20	950	EGW2CM680G20OT
		12.5×16	1060	EGW2CM680W16OT
	82	12.5×20	1260	EGW2CM820W20OT
12.5×20		1350	EGW2CM101W20OT	
100	12.5×25	1750	EGW2CM151W25OT	
	16×20	1790	EGW2CM151L20OT	
150	16×25	2130	EGW2CM221L25OT	
	18×30	2520	EGW2CM331M30OT	
220	18×30	2520	EGW2CM331M30OT	
	18×35	2880	EGW2CM471M35OT	
200(2D)	1	6.3×7	45	EGW2DM010E07OT
		6.3×9	50	EGW2DM010E09OT
	1.2	6.3×7	50	EGW2DM1R2E07OT
		6.3×9	55	EGW2DM1R2E09OT
	1.5	6.3×7	55	EGW2DM1R5E07OT
		6.3×9	60	EGW2DM1R5E09OT
	1.8	6.3×7	60	EGW2DM1R8E07OT
		6.3×9	66	EGW2DM1R8E09OT
	2.2	6.3×9	72	EGW2DM2R2E09OT
		6.3×12	81	EGW2DM2R2E12OT
	2.8	6.3×9	81	EGW2DM2R8E09OT
		6.3×12	88	EGW2DM2R8E12OT
	3.3	6.3×9	105	EGW2DM3R3E09OT
		6.3×12	112	EGW2DM3R3E12OT
	4.7	6.3×12	115	EGW2DM4R7E12OT
		8×9	117	EGW2DM4R7F09OT
	8×12	120	EGW2DM4R7F12OT	

WV (Vdc)	Cap (μF)	Size D×L(mm)	Rated ripple current	Part Number
200(2D)	5.6	8×9	120	EGW2DM5R6F09OT
		8×12	126	EGW2DM5R6F12OT
	6.8	8×9	126	EGW2DM6R8F09OT
		8×12	132	EGW2DM6R8F12OT
	8.2	8×9	180	EGW2DM8R2F09OT
		8×12	200	EGW2DM8R2F12OT
	10	8×9	190	EGW2DM100F09OT
		8×12	230	EGW2DM100F12OT
	15	8×16	310	EGW2DM150F16OT
		10×12	310	EGW2DM150G12OT
	22	10×16	475	EGW2DM220G16OT
		10×20	650	EGW2DM330G20OT
	33	12.5×16	650	EGW2DM330W16OT
		12.5×16	880	EGW2DM470W16OT
	47	12.5×20	980	EGW2DM470W20OT
		12.5×25	1300	EGW2DM680W25OT
82	16×20	1380	EGW2DM820L20OT	
	16×20	1420	EGW2DM101L20OT	
100	16×25	1494	EGW2DM101L25OT	
	16×25	1680	EGW2DM151L25OT	
150	16×30	1989	EGW2DM151L30OT	
	18×30	2150	EGW2DM221M30OT	
220	18×30	2150	EGW2DM221M30OT	
	18×35	2250	EGW2DM331M35OT	
250(2E)	1	6.3×7	45	EGW2EM010E07OT
		6.3×9	50	EGW2EM010E09OT
	1.2	6.3×7	50	EGW2EM1R2E07OT
		6.3×9	55	EGW2EM1R2E09OT
	1.5	6.3×7	55	EGW2EM1R5E07OT
		6.3×9	60	EGW2EM1R5E09OT
	1.8	6.3×7	61	EGW2EM1R8E07OT
		6.3×9	70	EGW2EM1R8E09OT
	2.2	6.3×9	72	EGW2EM2R2E09OT
		6.3×12	81	EGW2EM2R2E12OT
	2.8	6.3×9	81	EGW2EM2R8E09OT
		6.3×12	88	EGW2EM2R8E12OT
	3.3	6.3×9	102	EGW2EM3R3E09OT
		6.3×12	112	EGW2EM3R3E12OT
	4.7	6.3×9	112	EGW2EM4R7E09OT
		6.3×12	115	EGW2EM4R7E12OT
	5.6	8×9	115	EGW2EM4R7F09OT
		8×12	120	EGW2EM4R7F12OT
	6.8	8×9	120	EGW2EM5R6F09OT
		8×12	126	EGW2EM5R6F12OT
8.2	8×9	145	EGW2EM6R8F09OT	
	8×12	150	EGW2EM6R8F12OT	
10	8×12	200	EGW2EM8R2F12OT	
	8×16	260	EGW2EM8R2F16OT	
15	8×12	220	EGW2EM100F12OT	
	8×16	275	EGW2EM100F16OT	
22	8×16	350	EGW2EM150F16OT	
	10×12	360	EGW2EM150G12OT	
33	10×16	480	EGW2EM220G16OT	
	10×20	500	EGW2EM220G20OT	
47	10×20	600	EGW2EM330G20OT	
	12.5×16	600	EGW2EM330W16OT	
68	12.5×20	660	EGW2EM330W20OT	
	12.5×16	880	EGW2EM470W16OT	
82	12.5×20	980	EGW2EM470W20OT	
	12.5×25	1180	EGW2EM680W25OT	
100	16×20	1250	EGW2EM680L20OT	
	16×20	1320	EGW2EM820L20OT	
150	16×20	1360	EGW2EM101L20OT	
	16×25	1420	EGW2EM101L25OT	

CD11GAS series

■ STANDARD RATINGS (Rated ripple current: mA rms/105°C 100kHz)

WV (Vdc)	Cap (µF)	Size D×L(mm)	Rated ripple current	Part Number
250(2E)	150	16×30	1820	EGW2EM151L30OT
		18×25	1820	EGW2EM151M25OT
	220	18×30	2150	EGW2EM221M30OT
	330	18×40	2310	EGW2EM331M40OT
315(2F)	2.2	6.3×9	82	EGW2FM2R2E09OT
	3.3	6.3×12	100	EGW2FM3R3E12OT
	4.7	8×9	120	EGW2FM4R7F09OT
	5.6	8×12	142	EGW2FM5R6F12OT
	6.8	8×12	162	EGW2FM6R8F12OT
	8.2	8×12	194	EGW2FM8R2F12OT
	10	10×12	230	EGW2FM100G12OT
	15	10×16	340	EGW2FM150G16OT
	22	10×20	460	EGW2FM220G20OT
	33	12.5×20	600	EGW2FM330W20OT
	47	12.5×25	680	EGW2FM470W25OT
	350(2V)	1	6.3×9	55
		6.3×12	60	EGW2VM010E12OT
1.2		6.3×9	60	EGW2VM1R2E09OT
1.5		6.3×9	65	EGW2VM1R5E09OT
		6.3×12	70	EGW2VM1R5E12OT
1.8		6.3×9	72	EGW2VM1R8E09OT
		6.3×12	80	EGW2VM1R8E12OT
2.2		6.3×9	82	EGW2VM2R2E09OT
		6.3×12	86	EGW2VM2R2E12OT
2.8		8×9	88	EGW2VM2R8F09OT
		8×12	95	EGW2VM2R8F12OT
3.3		8×9	100	EGW2VM3R3F09OT
		8×12	108	EGW2VM3R3F12OT
4.7		8×9	114	EGW2VM4R7F09OT
		8×12	120	EGW2VM4R7F12OT
5.6		8×12	150	EGW2VM5R6F12OT
		8×16	162	EGW2VM5R6F16OT
6.8		8×12	172	EGW2VM6R8F12OT
		8×16	190	EGW2VM6R8F16OT
8.2		8×16	215	EGW2VM8R2F16OT
		10×12	215	EGW2VM8R2G12OT
10		8×20	260	EGW2VM100F20OT
		10×12	230	EGW2VM100G12OT
15		10×16	340	EGW2VM150G16OT
		10×20	460	EGW2VM220G20OT
22		10×20	460	EGW2VM220G20OT
		12.5×20	600	EGW2VM330W20OT
33		16×20	650	EGW2VM330L20OT
		16×20	700	EGW2VM470L20OT
68		16×25	780	EGW2VM680L25OT
		18×20	780	EGW2VM680M20OT
82		16×30	1000	EGW2VM820L30OT
	18×25	1000	EGW2VM820M25OT	
100	18×25	1120	EGW2VM101M25OT	
	18×30	1210	EGW2VM101M30OT	
400(2G)	1	6.3×7	61	EGW2GM010E07OT
		6.3×9	65	EGW2GM010E09OT
	1.2	6.3×9	68	EGW2GM1R2E09OT
		6.3×9	70	EGW2GM1R5E09OT
	1.5	6.3×12	74	EGW2GM1R5E12OT
		8×9	72	EGW2GM1R5F09OT
	1.8	6.3×9	72	EGW2GM1R8E09OT
		6.3×12	80	EGW2GM1R8E12OT
	2.2	8×9	76	EGW2GM1R8F09OT
		6.3×9	76	EGW2GM2R2E09OT
		6.3×12	85	EGW2GM2R2E12OT
		8×9	85	EGW2GM2R2F09OT
		8×12	90	EGW2GM2R2F12OT

WV (Vdc)	Cap (µF)	Size D×L(mm)	Rated ripple current	Part Number
400(2G)	2.8	6.3×12	90	EGW2GM2R8E12OT
		8×9	90	EGW2GM2R8F09OT
		8×12	94	EGW2GM2R8F12OT
	3.3	6.3×12	90	EGW2GM3R3E12OT
		8×9	100	EGW2GM3R3F09OT
		8×12	102	EGW2GM3R3F12OT
	4.7	8×10	110	EGW2GM4R7F10OT
		8×12	120	EGW2GM4R7F12OT
		10×9	120	EGW2GM4R7G09OT
	5.6	10×12	128	EGW2GM4R7G12OT
		8×12	145	EGW2GM5R6F12OT
		10×12	156	EGW2GM5R6G12OT
	6.8	8×12	172	EGW2GM6R8F12OT
		8×16	206	EGW2GM6R8F16OT
		10×12	206	EGW2GM6R8G12OT
	8.2	10×12	220	EGW2GM8R2G12OT
		10×16	232	EGW2GM8R2G16OT
		10×16	253	EGW2GM100G16OT
10	10×20	275	EGW2GM100G20OT	
	10×16	270	EGW2GM120G16OT	
	10×20	280	EGW2GM120G20OT	
15	10×20	324	EGW2GM150G20OT	
	12.5×16	324	EGW2GM150W16OT	
	12.5×20	480	EGW2GM220W20OT	
22	12.5×25	500	EGW2GM220W25OT	
	12.5×25	550	EGW2GM330W25OT	
	16×20	585	EGW2GM330L20OT	
33	16×20	650	EGW2GM470L20OT	
	16×25	730	EGW2GM470L25OT	
	16×30	770	EGW2GM560L30OT	
68	16×30	810	EGW2GM680L30OT	
	18×25	830	EGW2GM680M25OT	
	18×30	980	EGW2GM820M30OT	
100	18×30	1025	EGW2GM101M30OT	
	18×40	1340	EGW2GM151M40OT	
	18×45	1470	EGW2GM181M45OT	
450(2W)	1	6.3×9	76	EGW2WM010E09OT
		6.3×12	77	EGW2WM010E12OT
	1.2	8×9	80	EGW2WM1R2F09OT
		8×9	82	EGW2WM1R5F09OT
	1.5	8×12	85	EGW2WM1R5F12OT
		8×9	85	EGW2WM1R8F09OT
	1.8	8×12	88	EGW2WM1R8F12OT
		10×9	90	EGW2WM1R8G09OT
		8×9	86	EGW2WM2R2F09OT
	2.2	8×12	92	EGW2WM2R2F12OT
		10×9	92	EGW2WM2R2G09OT
	2.8	8×12	95	EGW2WM2R8F12OT
		10×9	95	EGW2WM2R8G09OT
	3.3	8×12	94	EGW2WM3R3F12OT
		10×9	98	EGW2WM3R3G09OT
	3.9	8×12	110	EGW2WM3R9F12OT
		10×9	115	EGW2WM3R9G09OT
	4.7	8×12	115	EGW2WM4R7F12OT
		10×12	123	EGW2WM4R7G12OT
	5.6	10×16	130	EGW2WM4R7G16OT
		10×12	142	EGW2WM5R6G12OT
	6.8	10×16	167	EGW2WM5R6G16OT
		10×12	175	EGW2WM6R8G12OT
	8.2	10×16	195	EGW2WM6R8G16OT
		10×16	220	EGW2WM8R2G16OT
	10	10×20	230	EGW2WM8R2G20OT
		10×16	255	EGW2WM100G16OT
		10×20	300	EGW2WM100G20OT

Radial Type

CD11GAS series

■ STANDARD RATINGS (Rated ripple current: mA rms/105°C 100kHz)

WV (Vdc)	Cap (μF)	Size D×L(mm)	Rated ripple current	Part Number
450(2W)	15	12.5×16	365	EGW2WM150W16OT
		12.5×20	410	EGW2WM150W20OT
		12.5×20	480	EGW2WM220W20OT
	22	12.5×25	530	EGW2WM220W25OT
		16×20	530	EGW2WM220L20OT
	33	16×20	600	EGW2WM330L20OT
		16×25	720	EGW2WM470L25OT
	47	16×30	800	EGW2WM470L30OT
		16×30	990	EGW2WM560L30OT
	56	18×25	1000	EGW2WM560M25OT
		18×25	1150	EGW2WM680M25OT
	68	18×30	1230	EGW2WM680M30OT
		18×30	1320	EGW2WM820M30OT
100	18×35	1370	EGW2WM101M35OT	
150	18×45	1700	EGW2WM151M45OT	
500(2H)	10	12.5×20	288	EGW2HM100W20OT
		12.5×25	302	EGW2HM100W25OT
	15	12.5×25	396	EGW2HM150W25OT
		16×20	396	EGW2HM150L20OT
	22	12.5×35	504	EGW2HM220W35OT
		16×25	504	EGW2HM220L25OT
	33	18×25	630	EGW2HM330M25OT
		18×30	792	EGW2HM470M30OT
	56	18×30	860	EGW2HM560M30OT
		18×35	1000	EGW2HM680M35OT
	68	22×35	1070	EGW2HM680O35OT
		22×35	1220	EGW2HM820O35OT
	100	22×35	1420	EGW2HM101O35OT

CD11GD series

- Endurance: +105 °C 8,000 hours
- Miniaturized and high stability
- RoHS Compliant

Upgrade



SPECIFICATIONS

Items	Characteristics									
Category Temperature Range	-40~+105°C									
Rated Voltage Range	140~450 V _{dc}									
Capacitance Tolerance	±20%(M) (at 20°C, 120Hz)									
Leakage Current	140~400 V _{dc}	450V _{dc}		Where, I: Max.leakage current (μA), C:Nominal capacitance (μF), V: Rated voltage (V)						
	I 0.02CV+10μA	I 0.03CV+10μA	(at 20°C after 2 minutes)							
Dissipation Factor (tan δ)	Rated Voltage(V _{dc})	140	160	200	250	315	350	400	450	(at 20°C, 120Hz)
	tan δ (max.)	0.15	0.15	0.15	0.15	0.20	0.20	0.20	0.20	
Low Temperature Characteristics (Max. Impedance Ratio)	Rated Voltage(V _{dc})	140	160	200	250	315	350	400	450	(at 120Hz)
	Z(-25°C)/Z(+20°C)	3	3	3	3	5	5	5	6	
	Z(-40°C)/Z(+20°C)	6	6	6	6	6	6	6	9	
Endurance	The specifications listed below shall be met when the capacitors are restored to 20 °C after DC voltage plus rated ripple current is applied for 8,000 hours at 105°C, the peak voltage shall not exceed the rated voltage.									
	Capacitance Change	±20% of the initial value								
	D.F. (tan δ)	200% of the initial specified value								
	Leakage Current	The initial specified value								
Shelf Life	The following specifications shall be satisfied when the capacitors are restored to 20°C after leaving them under no load at 105°C for 1,000 hours.									
	Capacitance Change	±20% of the initial value								
	D.F. (tan δ)	200% of the initial specified value								
	Leakage Current	200% of the initial specified value								

DIMENSIONS[mm]

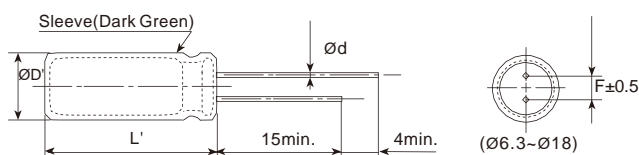

ØD	6.3	8	10	12.5	13	16	18
Ød	0.5	0.5	0.6	0.6	0.6	0.8	0.8
F	2.5	3.5	5.0	5.0	5.0	7.5	7.5
ØD'	ØD+0.5max.						
L'	L+2max.						

PART NUMBERING SYSTEM

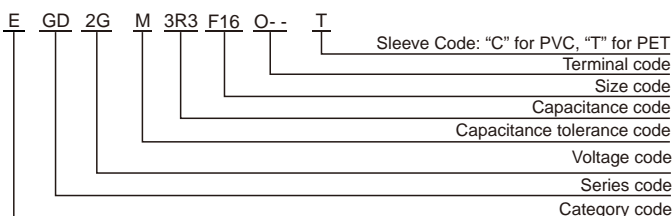

RATED RIPPLE CURRENT MULTIPLIERS

Frequency correction factor for ripple current

	Freq.(Hz)	120	1k	10k	100k
Rated voltage(V _{dc})		0.50	0.80	0.90	1.00
	140~450				

Radial Type

CD11GD series

■ STANDARD RATINGS (Rated ripple current: mA rms/105°C 100kHz)

WV (Vdc)	Cap (μF)	Size D×L (mm)	Rated ripple current	Part Number
140(2A)	10	6.3×12	100	EGD2AM100E12OT
	15	6.3×12	125	EGD2AM150E12OT
	22	8×12	250	EGD2AM220F12OT
	33	10×12	365	EGD2AM330G12OT
	47	8×20	430	EGD2AM470F20OT
	68	10×20	520	EGD2AM680G20OT
	100	12.5×16	650	EGD2AM101W16OT
	150	12.5×25	750	EGD2AM151W25OT
	220	16×20	850	EGD2AM221L20OT
160(2C)	1	6.3×7	34	EGD2CM010E07OT
		6.3×9	36	EGD2CM010E09OT
	1.5	6.3×7	38	EGD2CM1R5E07OT
		6.3×9	45	EGD2CM1R5E09OT
	1.8	6.3×7	49	EGD2CM1R8E07OT
		6.3×9	50	EGD2CM1R8E09OT
	2.2	6.3×7	53	EGD2CM2R2E07OT
		6.3×9	56	EGD2CM2R2E09OT
	2.8	6.3×7	57	EGD2CM2R8E07OT
		6.3×9	60	EGD2CM2R8E09OT
	3.3	6.3×7	61	EGD2CM3R3E07OT
		6.3×9	65	EGD2CM3R3E09OT
	3.9	6.3×7	65	EGD2CM3R9E07OT
		6.3×9	68	EGD2CM3R9E09OT
	4.7	6.3×7	66	EGD2CM4R7E07OT
		6.3×9	70	EGD2CM4R7E09OT
	5.6	6.3×12	72	EGD2CM4R7E12OT
		6.3×9	72	EGD2CM5R6E09OT
	6.8	6.3×12	74	EGD2CM5R6E12OT
		6.3×9	80	EGD2CM6R8E09OT
	8.2	6.3×12	84	EGD2CM6R8E12OT
		6.3×12	120	EGD2CM8R2E12OT
	8	8×9	135	EGD2CM8R2F09OT
		6.3×12	145	EGD2CM100E12OT
	10	8×9	165	EGD2CM100F09OT
		8×12	206	EGD2CM100F12OT
	12	8×9	180	EGD2CM120F09OT
		8×9	192	EGD2CM150F09OT
	15	8×12	213	EGD2CM150F12OT
		8×12	267	EGD2CM220F12OT
	22	8×16	330	EGD2CM220F16OT
		10×12	330	EGD2CM220G12OT
	33	10×12	400	EGD2CM330G12OT
10×16		425	EGD2CM330G16OT	
47	10×16	455	EGD2CM470G16OT	
	10×20	500	EGD2CM470G20OT	
56	10×20	530	EGD2CM560G20OT	
	10×20	550	EGD2CM680G20OT	
68	12.5×16	565	EGD2CM680W16OT	
	12.5×20	640	EGD2CM820W20OT	
82	12.5×20	700	EGD2CM101W20OT	
	12.5×25	722	EGD2CM101W25OT	
100	12.5×25	755	EGD2CM151W25OT	
	16×20	760	EGD2CM151L20OT	
220	16×25	900	EGD2CM221L25OT	
	18×30	1100	EGD2CM331M30OT	
200(2D)	1	6.3×7	35	EGD2DM010E07OT
		6.3×9	38	EGD2DM010E09OT
	1.2	6.3×7	38	EGD2DM1R2E07OT
		6.3×9	42	EGD2DM1R2E09OT
	1.5	6.3×7	49	EGD2DM1R5E07OT
		6.3×9	50	EGD2DM1R5E09OT
	1.8	6.3×7	50	EGD2DM1R8E07OT
		6.3×9	54	EGD2DM1R8E09OT

WV (Vdc)	Cap (μF)	Size D×L (mm)	Rated ripple current	Part Number
200(2D)	2.2	6.3×7	55	EGD2DM2R2E07OT
		6.3×9	60	EGD2DM2R2E09OT
	2.8	6.3×7	61	EGD2DM2R8E07OT
		6.3×9	68	EGD2DM2R8E09OT
	3.3	6.3×7	65	EGD2DM3R3E07OT
		6.3×9	72	EGD2DM3R3E09OT
	4.7	6.3×9	76	EGD2DM4R7E09OT
		6.3×12	85	EGD2DM4R7E12OT
	5.6	6.3×12	90	EGD2DM5R6E12OT
		8×9	92	EGD2DM5R6F09OT
	6.8	6.3×12	94	EGD2DM6R8E12OT
		8×9	98	EGD2DM6R8F09OT
	8.2	8×12	110	EGD2DM6R8F12OT
		8×9	145	EGD2DM8R2F09OT
	10	8×12	155	EGD2DM8R2F12OT
		8×9	165	EGD2DM100F09OT
	15	8×12	180	EGD2DM100F12OT
		8×12	200	EGD2DM150F12OT
	22	8×16	225	EGD2DM150F16OT
		8×16	320	EGD2DM220F16OT
	33	10×12	320	EGD2DM220G12OT
		10×16	380	EGD2DM220G16OT
	47	10×16	425	EGD2DM330G16OT
		10×20	450	EGD2DM330G20OT
68	12.5×13	430	EGD2DM330W13OT	
	10×20	520	EGD2DM470G20OT	
82	12.5×16	520	EGD2DM470W16OT	
	12.5×20	600	EGD2DM680W20OT	
100	12.5×25	665	EGD2DM680W25OT	
	12.5×20	670	EGD2DM820W20OT	
150	12.5×25	700	EGD2DM101W25OT	
	16×20	700	EGD2DM101L20OT	
1	16×25	820	EGD2DM151L25OT	
	16×30	895	EGD2DM151L30OT	
250(2E)	1	6.3×7	36	EGD2EM010E07OT
		6.3×9	40	EGD2EM010E09OT
	1.2	6.3×7	41	EGD2EM1R2E07OT
		6.3×9	46	EGD2EM1R2E09OT
	1.5	6.3×7	51	EGD2EM1R5E07OT
		6.3×9	54	EGD2EM1R5E09OT
	1.8	6.3×7	54	EGD2EM1R8E07OT
		6.3×9	58	EGD2EM1R8E09OT
	2.2	6.3×7	55	EGD2EM2R2E07OT
		6.3×9	62	EGD2EM2R2E09OT
	2.8	6.3×7	63	EGD2EM2R8E07OT
		6.3×9	70	EGD2EM2R8E09OT
	3.3	6.3×9	75	EGD2EM3R3E09OT
		6.3×12	80	EGD2EM3R3E12OT
	4.7	6.3×12	92	EGD2EM4R7E12OT
		8×9	92	EGD2EM4R7F09OT
	5.6	8×12	102	EGD2EM4R7F12OT
		8×9	95	EGD2EM5R6F09OT
	6.8	8×12	105	EGD2EM5R6F12OT
		8×9	105	EGD2EM6R8F09OT
	8.2	8×12	109	EGD2EM6R8F12OT
		8×9	120	EGD2EM8R2F09OT
	10	8×12	132	EGD2EM8R2F12OT
		8×10	187	EGD2EM100F10OT
15	8×12	200	EGD2EM100F12OT	
	10×9	175	EGD2EM100G09OT	
1	8×16	225	EGD2EM150F16OT	
	10×12	225	EGD2EM150G12OT	

CD11GD series

■ STANDARD RATINGS (Rated ripple current: mArms/105°C 100kHz)

WV (Vdc)	Cap (μF)	Size D×L(mm)	Rated ripple current	Part Number
250(2E)	22	8×16	350	EGD2EM220F16OT
		10×16	380	EGD2EM220G16OT
		10×20	430	EGD2EM330G20OT
	33	12.5×16	450	EGD2EM330W16OT
		12.5×16	520	EGD2EM470W16OT
	47	12.5×20	580	EGD2EM470W20OT
		12.5×25	660	EGD2EM680W25OT
	68	16×20	660	EGD2EM680L20OT
		16×20	720	EGD2EM820L20OT
	82	16×25	760	EGD2EM820L25OT
		16×20	765	EGD2EM101L20OT
	100	16×25	790	EGD2EM101L25OT
		16×30	885	EGD2EM151L30OT
	150	18×25	885	EGD2EM151M25OT
315(2F)		2.2	6.3×9	66
	3.3	6.3×9	74	EGD2FM3R3E09OT
	4.7	6.3×12	90	EGD2FM4R7E12OT
	5.6	8×9	95	EGD2FM5R6F09OT
	6.8	8×9	102	EGD2FM6R8F09OT
	8.2	8×12	120	EGD2FM8R2F12OT
	10	10×12	205	EGD2FM100G12OT
	15	10×16	260	EGD2FM150G16OT
	22	10×20	370	EGD2FM220G20OT
	33	12.5×20	450	EGD2FM330W20OT
	47	12.5×20	580	EGD2FM470W20OT
350(2V)	1	6.3×7	40	EGD2VM010E07OT
		6.3×9	45	EGD2VM010E09OT
	1.2	6.3×7	55	EGD2VM1R2E07OT
		6.3×9	50	EGD2VM1R2E09OT
	1.5	6.3×9	55	EGD2VM1R5E09OT
		6.3×12	60	EGD2VM1R5E12OT
	1.8	6.3×9	60	EGD2VM1R8E09OT
		6.3×12	64	EGD2VM1R8E12OT
	2.2	6.3×9	66	EGD2VM2R2E09OT
		6.3×12	70	EGD2VM2R2E12OT
		8×9	72	EGD2VM2R2F09OT
	2.8	8×9	76	EGD2VM2R8F09OT
		8×12	80	EGD2VM2R8F12OT
		6.3×12	77	EGD2VM3R3E12OT
	3.3	8×9	78	EGD2VM3R3F09OT
		8×12	82	EGD2VM3R3F12OT
	4.7	8×9	90	EGD2VM4R7F09OT
		8×12	102	EGD2VM4R7F12OT
	5.6	8×12	110	EGD2VM5R6F12OT
		10×9	110	EGD2VM5R6G09OT
	6.8	8×12	120	EGD2VM6R8F12OT
		10×9	120	EGD2VM6R8G09OT
	8.2	8×16	140	EGD2VM8R2F16OT
		10×12	140	EGD2VM8R2G12OT
	10	8×20	226	EGD2VM100F20OT
		10×12	205	EGD2VM100G12OT
	15	10×16	260	EGD2VM150G16OT
		10×20	285	EGD2VM150G20OT
	22	10×20	370	EGD2VM220G20OT
		12.5×16	370	EGD2VM220W16OT
	33	12.5×20	450	EGD2VM330W20OT
		12.5×25	480	EGD2VM330W25OT
	47	16×20	600	EGD2VM470L20OT
		16×25	720	EGD2VM680L25OT
	68	18×20	720	EGD2VM680M20OT
		16×30	770	EGD2VM820L30OT
	82	18×25	770	EGD2VM820M25OT
		16×30	850	EGD2VM101L30OT
	100	18×25	850	EGD2VM101M25OT

WV (Vdc)	Cap (μF)	Size D×L(mm)	Rated ripple current	Part Number
400(2G)	1	6.3×7	50	EGD2GM010E07OT
		6.3×9	55	EGD2GM010E09OT
	1.2	6.3×9	59	EGD2GM1R2E09OT
		6.3×12	63	EGD2GM1R2E12OT
	1.5	6.3×9	65	EGD2GM1R5E09OT
		6.3×12	68	EGD2GM1R5E12OT
	1.8	6.3×9	68	EGD2GM1R8E09OT
		6.3×12	71	EGD2GM1R8E12OT
	2.2	6.3×9	68	EGD2GM2R2E09OT
		6.3×12	72	EGD2GM2R2E12OT
		8×9	75	EGD2GM2R2F09OT
	2.8	8×12	78	EGD2GM2R2F12OT
		6.3×12	74	EGD2GM2R8E12OT
		8×9	78	EGD2GM2R8F09OT
	3.3	8×12	81	EGD2GM2R8F12OT
		8×7	78	EGD2GM3R3F07OT
		8×9	85	EGD2GM3R3F09OT
	4.7	8×12	91	EGD2GM3R3F12OT
		8×9	90	EGD2GM4R7F09OT
	5.6	8×12	104	EGD2GM4R7F12OT
		8×12	114	EGD2GM5R6F12OT
	6.8	8×12	124	EGD2GM5R6G12OT
		10×12	125	EGD2GM6R8F12OT
	8.2	10×12	140	EGD2GM6R8G12OT
		10×12	185	EGD2GM8R2G12OT
	10	10×16	218	EGD2GM8R2G16OT
		10×12	220	EGD2GM100G12OT
	15	10×16	230	EGD2GM100G16OT
		10×20	255	EGD2GM150G20OT
	22	12.5×16	270	EGD2GM150W16OT
		12.5×16	370	EGD2GM220W16OT
	33	12.5×20	400	EGD2GM220W20OT
		12.5×25	520	EGD2GM330W25OT
	47	13×20	465	EGD2GM330K20OT
		16×20	520	EGD2GM330L20OT
	68	12.5×30	565	EGD2GM470W30OT
		16×20	565	EGD2GM470L20OT
	82	16×25	590	EGD2GM470L25OT
		16×30	680	EGD2GM680L30OT
	100	18×25	700	EGD2GM680M25OT
		18×25	770	EGD2GM820M25OT
	150	18×30	900	EGD2GM101M30OT
18×40		1250	EGD2GM151M40OT	
450(2W)	1	6.3×9	55	EGD2WM010E09OT
		6.3×12	58	EGD2WM010E12OT
	1.2	6.3×9	60	EGD2WM1R2E09OT
		8×9	65	EGD2WM1R5F09OT
	1.5	8×12	70	EGD2WM1R5F12OT
		8×9	68	EGD2WM1R8F09OT
	1.8	8×12	72	EGD2WM1R8F12OT
		8×9	72	EGD2WM2R2F09OT
	2.2	8×12	74	EGD2WM2R2F12OT
		8×9	75	EGD2WM2R8F09OT
	2.8	8×12	77	EGD2WM2R8F12OT
		8×12	80	EGD2WM3R3F12OT
	3.3	8×16	86	EGD2WM3R3F16OT
		10×9	80	EGD2WM3R3G09OT
	4.7	8×12	84	EGD2WM4R7F12OT
		8×16	92	EGD2WM4R7F16OT
	5.6	10×12	94	EGD2WM4R7G12OT
		10×12	102	EGD2WM5R6G12OT
	6.8	10×16	115	EGD2WM5R6G16OT
		10×12	130	EGD2WM6R8G12OT
	100	10×16	142	EGD2WM6R8G16OT

Radial Type

CD11GD series

■ STANDARD RATINGS (Rated ripple current: mA rms/105°C 100kHz)

WV (Vdc)	Cap (μF)	Size D×L(mm)	Rated ripple current	Part Number
450(2W)	8.2	10×16	185	EGD2WM8R2G16OT
		10×20	209	EGD2WM8R2G20OT
	10	10×16	218	EGD2WM100G16OT
		10×20	225	EGD2WM100G20OT
	15	12.5×16	300	EGD2WM150W16OT
		12.5×20	332	EGD2WM150W20OT
	22	12.5×20	385	EGD2WM220W20OT
		12.5×25	427	EGD2WM220W25OT
	33	10×45	510	EGD2WM330G45OT
		12.5×30	495	EGD2WM330W30OT
		16×20	495	EGD2WM330L20OT
	47	12.5×35	595	EGD2WM470W35OT
		16×25	630	EGD2WM470L25OT
	68	18×25	740	EGD2WM680M25OT
	82	18×30	800	EGD2WM820M30OT
	100	18×35	890	EGD2WM101M35OT
150	18×45	1085	EGD2WM151M45OT	

CD11GHS series

- Upgrade for CD11GH Series, longer life, better performance, cost-effective
- Endurance: +105°C 6,000 hours
- Suitable for electronic ballast and electronic energy saving lamp.
- RoHS Compliant



SPECIFICATIONS

Items	Characteristics										
Category Temperature Range	-40~+105°C										
Rated Voltage Range	140~500 V _{dc}										
Capacitance Tolerance	±20%(M) (at 20°C, 120Hz)										
Leakage Current	140~400 V _{dc}	450~500 V _{dc}		Where, I: Max.leakage current (μA), C:Nominal capacitance (μF), V: Rated voltage (V) (at 20°C after 2 minutes)							
	I 0.02CV+10μA	I 0.03CV+10μA									
Dissipation Factor (tan δ)	Rated Voltage(V _{dc})	140	160	200	250	315	350	400	450	500	(at 20°C, 120Hz)
	tan (max.)	0.15	0.15	0.15	0.15	0.20	0.20	0.20	0.20	0.24	
Low Temperature Characteristics (Max. Impedance Ratio)	Rated Voltage(V _{dc})	140	160	200	250	315	350	400	450	500	(at 120Hz)
	Z(+25°C)/Z(+20°C)	3	3	3	3	5	5	5	6	6	
	Z(-40°C)/Z(+20°C)	6	6	6	6	6	6	6	6	9	
Endurance	The specifications listed below shall be met when the capacitors are restored to 20°C after DC voltage plus rated ripple current is applied for 6,000 hours at 105°C, the peak voltage shall not exceed the rated voltage.										
	Capacitance Change	±20% of the initial value									
	D.F. (tan δ)	200% of the initial specified value									
	Leakage Current	The initial specified value									
Shelf Life	The following specifications shall be satisfied when the capacitors are restored to 20°C after leaving them under no load at 105°C for 1,000 hours.										
	Capacitance Change	±20% of the initial value									
	D.F. (tan δ)	200% of the initial specified value									
	Leakage Current	200% of the initial specified value									

DIMENSIONS[mm]

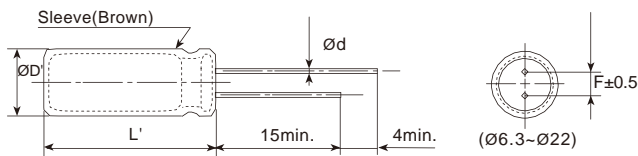

ØD	6.3	8	10	12.5	13	16	18	22
Ød	0.5	0.5	0.6	0.6	0.6	0.8	0.8	0.8
F	2.5	3.5	5.0	5.0	5.0	7.5	7.5	10
ØD'	ØD+0.5max.							
L'	L+2max.							

PART NUMBERING SYSTEM

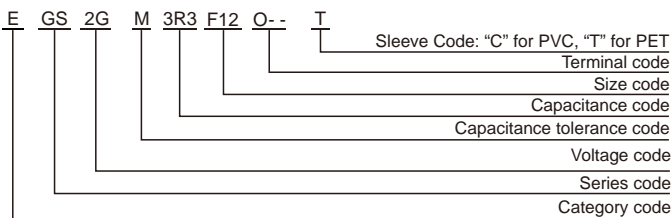

RATED RIPPLE CURRENT MULTIPLIERS

Frequency correction factor for ripple current

Rated voltage(V _{dc})	Freq.(Hz)	120	1k	10k	100k
140~500		0.50	0.80	0.90	1.00

CD11GHS series

■ STANDARD RATINGS (Rated ripple current: mA rms/105°C 100kHz)

WV (Vdc)	Cap (μF)	Size D×L(mm)	Rated ripple current	Part Number
140(2A)	10	6.3×12	100	EGS2AM100E12OT
	15	6.3×12	125	EGS2AM150E12OT
	22	8×12	250	EGS2AM220F12OT
	33	10×12	365	EGS2AM330G12OT
	47	8×20	430	EGS2AM470F20OT
	68	10×20	520	EGS2AM680G20OT
	100	12.5×16	650	EGS2AM101W16OT
	150	12.5×25	750	EGS2AM151W25OT
160(2C)	1	6.3×7	34	EGS2CM010E07OT
		6.3×9	36	EGS2CM010E09OT
	1.5	6.3×7	38	EGS2CM1R5E07OT
		6.3×9	45	EGS2CM1R5E09OT
	1.8	6.3×7	49	EGS2CM1R8E07OT
		6.3×9	50	EGS2CM1R8E09OT
	2.2	6.3×7	53	EGS2CM2R2E07OT
		6.3×9	56	EGS2CM2R2E09OT
	2.8	6.3×7	58	EGS2CM2R8E07OT
		6.3×9	62	EGS2CM2R8E09OT
	3.3	6.3×7	62	EGS2CM3R3E07OT
		6.3×9	67	EGS2CM3R3E09OT
	4.7	6.3×7	68	EGS2CM4R7E07OT
		6.3×9	72	EGS2CM4R7E09OT
	5.6	6.3×9	75	EGS2CM5R6E09OT
		6.3×12	79	EGS2CM5R6E12OT
	6.8	6.3×9	84	EGS2CM6R8E09OT
		6.3×12	89	EGS2CM6R8E12OT
	8.2	6.3×12	120	EGS2CM8R2E12OT
		8×9	135	EGS2CM8R2F09OT
	10	8×9	165	EGS2CM100F09OT
		8×12	206	EGS2CM100F12OT
	15	8×9	215	EGS2CM150F09OT
		8×12	230	EGS2CM150F12OT
	22	8×12	306	EGS2CM220F12OT
		8×16	340	EGS2CM220F16OT
	33	10×12	400	EGS2CM330G12OT
		10×16	425	EGS2CM330G16OT
	47	10×16	460	EGS2CM470G16OT
		10×20	500	EGS2CM470G20OT
	68	10×20	560	EGS2CM680G20OT
		12.5×16	570	EGS2CM680W16OT
	82	12.5×20	665	EGS2CM820W20OT
12.5×20		720	EGS2CM101W20OT	
100	12.5×25	740	EGS2CM101W25OT	
	12.5×25	780	EGS2CM151W25OT	
150	16×20	780	EGS2CM151L20OT	
	16×25	980	EGS2CM221L25OT	
330	18×30	1145	EGS2CM331M30OT	
200(2D)	1	6.3×7	35	EGS2DM010E07OT
		6.3×9	38	EGS2DM010E09OT
	1.5	6.3×7	49	EGS2DM1R5E07OT
		6.3×9	50	EGS2DM1R5E09OT
	1.8	6.3×7	50	EGS2DM1R8E07OT
		6.3×9	54	EGS2DM1R8E09OT
	2.2	6.3×7	55	EGS2DM2R2E07OT
		6.3×9	60	EGS2DM2R2E09OT
	2.8	6.3×7	61	EGS2DM2R8E07OT
		6.3×9	68	EGS2DM2R8E09OT
	3.3	6.3×7	68	EGS2DM3R3E07OT
		6.3×9	74	EGS2DM3R3E09OT
	4.7	6.3×9	82	EGS2DM4R7E09OT
		6.3×12	90	EGS2DM4R7E12OT
	5.6	6.3×12	95	EGS2DM5R6E12OT
		8×9	95	EGS2DM5R6F09OT

WV (Vdc)	Cap (μF)	Size D×L(mm)	Rated ripple current	Part Number
200(2D)	6.8	8×9	105	EGS2DM6R8F09OT
		8×12	120	EGS2DM6R8F12OT
	8.2	8×9	150	EGS2DM8R2F09OT
		8×12	160	EGS2DM8R2F12OT
	10	8×9	170	EGS2DM100F09OT
		8×12	185	EGS2DM100F12OT
	15	8×12	225	EGS2DM150F12OT
		8×16	250	EGS2DM150F16OT
	22	8×16	360	EGS2DM220F16OT
		10×16	400	EGS2DM220G16OT
	33	10×16	425	EGS2DM330G16OT
		10×20	450	EGS2DM330G20OT
	47	10×20	550	EGS2DM470G20OT
		12.5×16	550	EGS2DM470W16OT
	68	12.5×20	635	EGS2DM680W20OT
12.5×25		700	EGS2DM680W25OT	
82	12.5×20	705	EGS2DM820W20OT	
	12.5×25	735	EGS2DM101W25OT	
100	16×20	735	EGS2DM101L20OT	
	16×25	855	EGS2DM151L25OT	
150	16×30	920	EGS2DM151L30OT	
	1	6.3×7	36	EGS2EM010E07OT
1.5		6.3×9	40	EGS2EM010E09OT
	1.8	6.3×7	51	EGS2EM1R5E07OT
2.2		6.3×9	54	EGS2EM1R5E09OT
	2.8	6.3×7	55	EGS2EM1R8E07OT
3.3		6.3×9	59	EGS2EM1R8E09OT
	4.7	6.3×7	64	EGS2EM2R2E07OT
5.6		6.3×9	71	EGS2EM2R2E09OT
	6.8	6.3×7	71	EGS2EM2R8E07OT
8.2		6.3×9	75	EGS2EM2R8E09OT
	10	6.3×9	78	EGS2EM3R3E09OT
15		6.3×12	83	EGS2EM3R3E12OT
	22	6.3×12	91	EGS2EM4R7E12OT
33		8×9	97	EGS2EM4R7F09OT
	47	8×12	102	EGS2EM4R7F12OT
5.6		8×9	95	EGS2EM5R6F09OT
	6.8	8×12	105	EGS2EM5R6F12OT
8.2		8×9	105	EGS2EM6R8F09OT
	10	8×12	109	EGS2EM6R8F12OT
15		8×9	120	EGS2EM8R2F09OT
	22	8×12	132	EGS2EM8R2F12OT
33		8×12	170	EGS2EM100F12OT
	47	8×16	210	EGS2EM100F16OT
68		8×16	295	EGS2EM150F16OT
	82	10×12	295	EGS2EM150G12OT
100		8×16	360	EGS2EM220F16OT
	150	10×16	400	EGS2EM220G16OT
22		10×20	480	EGS2EM330G20OT
	33	12.5×16	480	EGS2EM330W16OT
47		12.5×16	560	EGS2EM470W16OT
	68	12.5×20	627	EGS2EM470W20OT
82		12.5×25	675	EGS2EM680W25OT
	100	16×20	675	EGS2EM680L20OT
150		16×20	730	EGS2EM820L20OT
	22	16×25	760	EGS2EM820L25OT
33		16×20	780	EGS2EM101L20OT
	47	16×25	820	EGS2EM101L25OT
68		16×30	930	EGS2EM151L30OT
	82	18×25	930	EGS2EM151M25OT

CD11GHS series

■ STANDARD RATINGS(Rated ripple current: mA rms/105°C 100kHz)

WV (Vdc)	Cap (μF)	Size D×L(mm)	Rated ripple current	Part Number
315(2F)	2.2	6.3×9	71	EGS2FM2R2E09OT
	3.3	6.3×9	78	EGS2FM3R3E09OT
	4.7	6.3×12	95	EGS2FM4R7E12OT
	5.6	8×9	100	EGS2FM5R6F09OT
	6.8	8×9	110	EGS2FM6R8F09OT
	8.2	8×12	130	EGS2FM8R2F12OT
	10	10×12	215	EGS2FM100G12OT
	15	10×16	325	EGS2FM150G16OT
	22	10×20	420	EGS2FM220G20OT
	33	12.5×20	540	EGS2FM330W20OT
47	12.5×20	630	EGS2FM470W20OT	
350(2V)	1	6.3×7	52	EGS2VM010E07OT
		6.3×9	58	EGS2VM010E09OT
	1.5	6.3×7	62	EGS2VM1R5E07OT
		6.3×9	68	EGS2VM1R5E09OT
	1.8	6.3×9	74	EGS2VM1R8E09OT
		6.3×12	80	EGS2VM1R8E12OT
	2.2	6.3×9	85	EGS2VM2R2E09OT
		6.3×12	90	EGS2VM2R2E12OT
	2.8	8×9	101	EGS2VM2R8F09OT
		8×12	106	EGS2VM2R8F12OT
	3.3	8×9	106	EGS2VM3R3F09OT
		8×12	110	EGS2VM3R3F12OT
	4.7	8×9	112	EGS2VM4R7F09OT
		8×12	120	EGS2VM4R7F12OT
	5.6	8×12	130	EGS2VM5R6F12OT
		8×16	150	EGS2VM5R6F16OT
	6.8	8×12	160	EGS2VM6R8F12OT
		8×16	170	EGS2VM6R8F16OT
	8.2	8×16	190	EGS2VM8R2F16OT
		8×20	230	EGS2VM100F20OT
	10	10×12	210	EGS2VM100G12OT
		10×16	280	EGS2VM150G16OT
	15	10×20	310	EGS2VM150G20OT
		10×20	385	EGS2VM220G20OT
	22	12.5×16	400	EGS2VM220W16OT
		12.5×20	515	EGS2VM330W20OT
	33	12.5×25	535	EGS2VM330W25OT
		16×20	650	EGS2VM470L20OT
	68	16×25	760	EGS2VM680L25OT
		18×20	760	EGS2VM680M20OT
82	16×30	910	EGS2VM820L30OT	
	18×25	910	EGS2VM820M25OT	
100	16×30	960	EGS2VM101L30OT	
	18×25	960	EGS2VM101M25OT	
400(2G)	1	6.3×7	63	EGS2GM010E07OT
		6.3×9	70	EGS2GM010E09OT
	1.5	6.3×9	72	EGS2GM1R5E09OT
		6.3×12	78	EGS2GM1R5E12OT
	1.8	6.3×9	80	EGS2GM1R8E09OT
		6.3×12	85	EGS2GM1R8E12OT
	2.2	6.3×9	85	EGS2GM2R2E09OT
		6.3×12	90	EGS2GM2R2E12OT
	2.8	8×12	105	EGS2GM2R2F12OT
		8×9	105	EGS2GM2R8F09OT
	3.3	8×12	110	EGS2GM2R8F12OT
		8×9	110	EGS2GM3R3F09OT
	4.7	8×12	120	EGS2GM3R3F12OT
		8×9	125	EGS2GM4R7F09OT
	5.6	8×12	140	EGS2GM4R7F12OT
		8×12	150	EGS2GM5R6F12OT
	6.8	10×12	160	EGS2GM5R6G12OT
		8×12	165	EGS2GM6R8F12OT
	10×12	180	EGS2GM6R8G12OT	

WV (Vdc)	Cap (μF)	Size D×L(mm)	Rated ripple current	Part Number	
400(2G)	8.2	10×12	200	EGS2GM8R2G12OT	
		10×16	220	EGS2GM8R2G16OT	
		10×12	230	EGS2GM100G12OT	
	10	10×16	252	EGS2GM100G16OT	
		12	10×16	262	EGS2GM120G16OT
		15	10×20	300	EGS2GM150G20OT
	22	12.5×16	370	EGS2GM220W16OT	
		12.5×20	400	EGS2GM220W20OT	
		12.5×25	520	EGS2GM330W25OT	
	33	13×20	465	EGS2GM330L20OT	
		16×20	520	EGS2GM330L20OT	
		16×20	580	EGS2GM470L20OT	
	56	16×25	650	EGS2GM560L25OT	
		16×30	760	EGS2GM680L30OT	
		18×25	760	EGS2GM680M25OT	
82	18×25	810	EGS2GM820M25OT		
	18×30	920	EGS2GM101M30OT		
	18×40	1280	EGS2GM151M40OT		
450(2W)	1	6.3×9	60	EGS2WM010E09OT	
		6.3×12	65	EGS2WM010E12OT	
	1.5	8×9	70	EGS2WM1R5F09OT	
		8×12	75	EGS2WM1R5F12OT	
	1.8	8×9	81	EGS2WM1R8F09OT	
		8×12	90	EGS2WM1R8F12OT	
	2.2	8×9	93	EGS2WM2R2F09OT	
		8×12	103	EGS2WM2R2F12OT	
	2.8	8×9	105	EGS2WM2R8F09OT	
		8×12	115	EGS2WM2R8F12OT	
	3.3	8×12	116	EGS2WM3R3F12OT	
		8×16	128	EGS2WM3R3F16OT	
	4.7	8×12	130	EGS2WM4R7F12OT	
		8×16	140	EGS2WM4R7F16OT	
	5.6	10×12	150	EGS2WM5R6G12OT	
10×16		162	EGS2WM5R6G16OT		
6.8	10×12	170	EGS2WM6R8G12OT		
	10×16	180	EGS2WM6R8G16OT		
8.2	10×16	210	EGS2WM8R2G16OT		
	10×20	230	EGS2WM8R2G20OT		
10	10×16	235	EGS2WM100G16OT		
	10×20	250	EGS2WM100G20OT		
15	12.5×16	320	EGS2WM150W16OT		
	12.5×20	350	EGS2WM150W20OT		
22	12.5×20	425	EGS2WM220W20OT		
	12.5×25	450	EGS2WM220W25OT		
33	16×20	510	EGS2WM330L20OT		
	16×25	640	EGS2WM470L25OT		
68	18×25	760	EGS2WM680M25OT		
	18×30	860	EGS2WM820M30OT		
100	18×35	920	EGS2WM101M35OT		
	18×45	1100	EGS2WM151M45OT		
500(2H)	10	12.5×20	259	EGS2HM100W20OT	
		12.5×25	272	EGS2HM100W25OT	
		12.5×25	356	EGS2HM150W25OT	
	15	16×20	356	EGS2HM150L20OT	
		12.5×35	453	EGS2HM220W35OT	
		16×25	453	EGS2HM220L25OT	
	22	18×25	567	EGS2HM330M25OT	
		18×30	713	EGS2HM470M30OT	
	56	18×30	770	EGS2HM560M30OT	
		18×35	900	EGS2HM680M35OT	
	68	22×35	1000	EGS2HM680O35OT	
		22×35	1150	EGS2HM820O35OT	
	100	22×35	1400	EGS2HM101O35OT	

Radial Type

CD11GM series

- Endurance: +105°C 3,000 hours
- Economical type, miniaturized
- RoHS Compliant



SPECIFICATIONS

Items	Characteristics						
Category Temperature Range	-40~+105°C						
Rated Voltage Range	160~450 V _{dc}						
Capacitance Tolerance	±20%(M) (at 20°C, 120Hz)						
Leakage Current	160~400 V _{dc}	450 V _{dc}		Where, I:Max.leakage current (μA), C:Nominal capacitance (μF), V: Rated voltage (V) (at 20°C after 2 minutes)			
	I 0.02CV+25μA	I 0.03CV+25μA					
Dissipation Factor (tan δ)	Rated Voltage(V _{dc})	160	200	250	400	450	(at 20°C, 120Hz)
	tan (max.)	0.15	0.15	0.15	0.20	0.20	
Low Temperature Characteristics (Max. Impedance Ratio)	Rated Voltage(V _{dc})	160	200	250	400	450	(at 120Hz)
	Z(-25°C)/Z(+20°C)	3	3	3	5	6	
	Z(-40°C)/Z(+20°C)	6	6	6	6	9	
Endurance	The specifications listed below shall be met when the capacitors are restored to 20°C after DC voltage plus rated ripple current is applied for 3,000 hours at 105°C, the peak voltage shall not exceed the rated voltage.						
	Capacitance Change	±20% of the initial value					
	D.F. (tan δ)	200% of the initial specified value					
	Leakage Current	The initial specified value					
Shelf Life	The following specifications shall be satisfied when the capacitors are restored to 20°C after leaving them under no load at 105°C for 1,000 hours.						
	Capacitance Change	±20% of the initial value					
	D.F. (tan δ)	200% of the initial specified value					
	Leakage Current	500% of the initial specified value					

DIMENSIONS[mm]

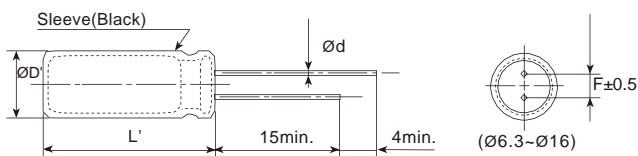

ØD	6.3	8	10	12.5	13	16
Ød	0.5	0.5	0.6	0.6	0.6	0.8
F	2.5	3.5	5.0	5.0	5.0	7.5
ØD'	ØD+0.5max.					
L'	L+2max.					

PART NUMBERING SYSTEM

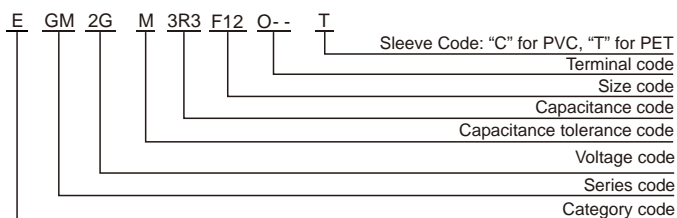

RATED RIPPLE CURRENT MULTIPLIERS

Frequency correction factor for ripple current

Rated voltage(V _{dc}) \ Freq.(Hz)	120	1k	10k	100k
160~450	0.50	0.80	0.90	1.00

CD11GM series

■ STANDARD RATINGS(Rated ripple current: mA rms/105°C 100kHz)

WV (Vdc)	Cap (μF)	Size DxL(mm)	Rated ripple current	Part Number
160(2C)	4.7	6.3x7	52	EGM2CM4R7E07OT
	5.6	6.3x9	58	EGM2CM5R6E09OT
	6.8	6.3x12	70	EGM2CM6R8E12OT
	8.2	6.3x12	100	EGM2CM8R2E12OT
			135	EGM2CM100E12OT
		8x9	135	EGM2CM100F09OT
	10	8x12	145	EGM2CM100F12OT
			155	EGM2CM150F09OT
		8x12	162	EGM2CM150F12OT
	22	8x12	220	EGM2CM220F12OT
			260	EGM2CM220G12OT
		10x12	260	EGM2CM220G12OT
	33	10x16	320	EGM2CM330G16OT
		10x16	365	EGM2CM470G16OT
	47	10x20	400	EGM2CM470G20OT
450			EGM2CM560G20OT	
68	10x20	500	EGM2CM680G20OT	
100	12.5x20	650	EGM2CM101W20OT	
200(2D)	4.7	6.3x9	52	EGM2DM4R7E09OT
	5.6	6.3x12	62	EGM2DM5R6E12OT
	6.8	6.3x12	76	EGM2DM6R8E12OT
	8.2	8x9	90	EGM2DM8R2F09OT
		8x12	95	EGM2DM8R2F12OT
	10	8x9	130	EGM2DM100F09OT
		8x12	145	EGM2DM100F12OT
	15	8x12	170	EGM2DM150F12OT
		8x16	185	EGM2DM150F16OT
	22	8x16	255	EGM2DM220F16OT
	33	10x16	330	EGM2DM330G16OT
	47	10x20	420	EGM2DM470G20OT
	56	12.5x20	500	EGM2DM560W20OT

WV (Vdc)	Cap (μF)	Size DxL(mm)	Rated ripple current	Part Number
250(2E)	4.7	6.3x9	80	EGM2EM4R7E09OT
		6.3x12	85	EGM2EM4R7E12OT
		8x9	85	EGM2EM4R7F09OT
	6.8	8x9	92	EGM2EM6R8F09OT
			96	EGM2EM6R8F12OT
		8x12	96	EGM2EM8R2F09OT
	8.2	8x12	100	EGM2EM8R2F12OT
		8x12	150	EGM2EM100F12OT
	10	10x9	150	EGM2EM100G09OT
		8x16	195	EGM2EM150F16OT
	22	10x16	280	EGM2EM220G16OT
	33	10x20	360	EGM2EM330G20OT
		12.5x16	360	EGM2EM330W16OT
		12.5x16	430	EGM2EM470W16OT
	47	12.5x20	455	EGM2EM470W20OT
400(2G)	1	6.3x9	35	EGM2GM1R5E09OT
	1.5	6.3x9	40	EGM2GM1R5E09OT
	1.8	6.3x12	49	EGM2GM1R8E12OT
	2.2	6.3x12	60	EGM2GM2R2E12OT
		8x9	60	EGM2GM2R2F09OT
	3.3	8x9	70	EGM2GM3R3F09OT
		8x12	75	EGM2GM3R3F12OT
	4.7	8x9	88	EGM2GM4R7F09OT
		8x12	95	EGM2GM4R7F12OT
		8x12	117	EGM2GM6R8F12OT
	6.8	8x16	130	EGM2GM6R8F16OT
		10x12	130	EGM2GM6R8G12OT
		8x16	170	EGM2GM100F16OT
	10	10x12	170	EGM2GM100G12OT
		10x16	195	EGM2GM100G16OT
10x16		230	EGM2GM150G16OT	
22	12.5x20	345	EGM2GM220W20OT	
33	13x20	445	EGM2GM330K20OT	
47	16x25	650	EGM2GM470L25OT	
450(2W)	2.2	8x9	65	EGM2WM2R2F09OT
	3.3	8x12	85	EGM2WM3R3F12OT
	4.7	8x12	105	EGM2WM4R7F12OT
	6.8	10x12	140	EGM2WM6R8G12OT
	10	10x16	205	EGM2WM100G16OT
	15	10x20	265	EGM2WM150G20OT
	22	12.5x20	360	EGM2WM220W20OT
	33	16x20	500	EGM2WM330L20OT
	47	16x25	665	EGM2WM470L25OT

RR series

■ STANDARD RATINGS

WV (Vdc)	Cap (μF)	Size DxL(mm)	tan	Impedance (max/20°C, 100kHz)	Rated ripple current (mA rms/105°C, 100kHz)	Part Number
6.3(OJ)	150	5x11	0.22	0.3	250	ERR0JM151D11OT
		6.3x7	0.22	0.3	250	ERR0JM151E07OT
	330	6.3x9	0.22	0.15	350	ERR0JM331E09OT
		6.3x11	0.22	0.13	405	ERR0JM331E11OT
	560	8x9	0.22	0.12	605	ERR0JM561F09OT
		8x12	0.22	0.072	760	ERR0JM561F12OT
	820	8x16	0.22	0.056	995	ERR0JM821F16OT
		10x9	0.22	0.085	800	ERR0JM821G09OT
	1000	10x12.5	0.22	0.053	1030	ERR0JM102G1BOT
		8x20	0.22	0.041	1250	ERR0JM122F20OT
	1200	10x16	0.22	0.038	1430	ERR0JM122G16OT
		1500	10x20	0.22	0.023	1820
	2200	10x25	0.24	0.022	2150	ERR0JM222G25OT
		3300	12.5x20	0.26	0.021	2360
	3900	12.5x25	0.26	0.018	2770	ERR0JM392W25OT
		4700	12.5x30	0.28	0.016	3290
	5600	12.5x35	0.30	0.015	3400	ERR0JM562W35OT
		6800	16x20	0.30	0.018	3140
	6800	16x25	0.32	0.016	3460	ERR0JM682L25OT
		10(1A)	100	5x7	0.18	1.38
5x11	0.18			0.3	250	ERR1AM101D11OT
220	6.3x7		0.18	0.35	405	ERR1AM221E07OT
	6.3x11		0.18	0.13	405	ERR1AM221E11OT
470	8x9		0.18	0.18	606	ERR1AM471F09OT
	8x11		0.18	0.072	760	ERR1AM471F11OT
680	8x16		0.18	0.056	995	ERR1AM681F16OT
	10x9		0.18	0.085	760	ERR1AM681G09OT
1000	10x12.5		0.18	0.053	1030	ERR1AM681G1BOT
	8x20		0.18	0.041	1250	ERR1AM102F20OT
1200	10x16		0.18	0.038	1430	ERR1AM102G16OT
	1500		10x20	0.18	0.023	1820
2200	10x25		0.18	0.022	2150	ERR1AM152G25OT
	3300		12.5x20	0.20	0.021	2360
3900	12.5x25		0.22	0.018	2770	ERR1AM332W25OT
	4700		12.5x30	0.22	0.016	3290
5600	16x20		0.22	0.018	3140	ERR1AM392L20OT
	16x25		0.24	0.015	3400	ERR1AM472W35OT
5600	16x25		0.26	0.016	3460	ERR1AM562L25OT
	16(1C)		56	5x7	0.14	0.7
5x11		0.14		0.3	250	ERR1CM560D11OT
120		6.3x7	0.14	0.4	300	ERR1CM121E07OT
		6.3x11	0.14	0.13	405	ERR1CM121E11OT
330		8x7	0.14	0.14	510	ERR1CM331F07OT
		8x12	0.14	0.072	760	ERR1CM331F12OT
470		8x16	0.14	0.056	795	ERR1CM471F16OT
		10x12.5	0.14	0.053	1030	ERR1CM471G1BOT
680		8x20	0.14	0.041	1250	ERR1CM681F20OT
		10x16	0.14	0.038	1430	ERR1CM681G16OT
1000		10x20	0.14	0.023	1820	ERR1CM102G20OT
		1200	10x25	0.14	0.022	2150
1500		12.5x20	0.14	0.021	2360	ERR1CM152W20OT
		2200	12.5x25	0.16	0.018	2770
2700		12.5x30	0.16	0.016	3290	ERR1CM272W30OT
		3300	16x20	0.16	0.018	3140
3900		12.5x35	0.18	0.015	3400	ERR1CM332W35OT
		3900	16x25	0.18	0.016	3460

WV (Vdc)	Cap (μF)	Size DxL(mm)	tan	Impedance (max/20°C, 100kHz)	Rated ripple current (mA rms/105°C, 100kHz)	Part Number	
25(1E)	47	5x11	0.12	0.3	250	ERR1EM470D11OT	
		6.3x7	0.12	1.1	200	ERR1EM470E07OT	
	100	6.3x9	0.12	0.13	405	ERR1EM101E11OT	
		8x7	0.12	0.3	430	ERR1EM101F07OT	
	220	8x9	0.12	0.1	600	ERR1EM221F09OT	
		8x12	0.12	0.072	760	ERR1EM221F12OT	
	330	8x16	0.12	0.056	995	ERR1EM331F16OT	
		470	8x20	0.12	0.041	1250	ERR1EM471F20OT
	680	10x12.5	0.12	0.053	1030	ERR1EM681G1BOT	
		820	10x16	0.12	0.038	1430	ERR1EM821G16OT
	1000	10x20	0.12	0.023	1820	ERR1EM102G20OT	
		1500	10x25	0.12	0.022	2150	ERR1EM152G25OT
	1800	12.5x20	0.12	0.021	2360	ERR1EM182W20OT	
		2200	12.5x30	0.12	0.016	3290	ERR1EM182W30OT
	2200	16x20	0.12	0.018	3140	ERR1EM182L20OT	
		2700	12.5x25	0.14	0.018	2770	ERR1EM222W25OT
	2700	12.5x35	0.14	0.015	3400	ERR1EM222W35OT	
		3460	16x25	0.14	0.016	3460	ERR1EM272L25OT
	35(1V)	33	5x7	0.10	1.15	160	ERR1VM330D07OT
			5x11	0.10	0.3	250	ERR1VM330D11OT
56		6.3x11	0.10	0.13	405	ERR1VM560E11OT	
		8x7	0.10	0.39	405	ERR1VM560F07OT	
150		8x9	0.10	0.17	600	ERR1VM151F09OT	
		8x12	0.10	0.072	760	ERR1VM151F12OT	
220		8x16	0.10	0.056	995	ERR1VM221F16OT	
		10x12.5	0.10	0.053	1030	ERR1VM221G1BOT	
270		8x20	0.10	0.041	1250	ERR1VM271F20OT	
		330	10x16	0.10	0.038	1430	ERR1VM331G16OT
470		10x20	0.10	0.023	1820	ERR1VM471G20OT	
		560	10x25	0.10	0.022	2150	ERR1VM561G25OT
680		12.5x20	0.10	0.021	2360	ERR1VM681W20OT	
		1000	12.5x25	0.10	0.018	2770	ERR1VM102W25OT
1200		12.5x30	0.10	0.016	3290	ERR1VM122W30OT	
		1500	16x20	0.10	0.018	3140	ERR1VM122L20OT
1500		12.5x35	0.10	0.015	3400	ERR1VM152W35OT	
		1800	16x25	0.10	0.016	3460	ERR1VM182L25OT
50(1H)		22	5x11	0.08	0.34	238	ERR1HM220D11OT
			6.3x7	0.08	0.52	200	ERR1HM220E07OT
	56	6.3x12	0.08	0.14	385	ERR1HM560E12OT	
		8x7	0.08	0.36	320	ERR1HM560F07OT	
	100	8x9	0.08	0.2	580	ERR1HM101F09OT	
		8x12	0.08	0.074	724	ERR1HM101F12OT	
	120	8x16	0.08	0.061	950	ERR1HM121F16OT	
		150	10x12.5	0.08	0.061	979	ERR1HM151G1BOT
	180	8x20	0.08	0.046	1190	ERR1HM181F20OT	
		220	10x16	0.08	0.042	1370	ERR1HM221G16OT
	270	10x20	0.08	0.03	1580	ERR1HM271G20OT	
		330	10x25	0.08	0.028	1870	ERR1HM331G25OT
	470	12.5x20	0.08	0.027	2050	ERR1HM471W20OT	
		560	12.5x25	0.08	0.023	2410	ERR1HM561W25OT
	680	12.5x30	0.08	0.021	2860	ERR1HM681W30OT	
		820	12.5x35	0.08	0.019	2960	ERR1HM821W35OT
	1000	16x20	0.08	0.023	2730	ERR1HM821L20OT	
		3010	16x25	0.08	0.021	3010	ERR1HM102L25OT

Radial Type

RE series

- Low impedance and high frequency.
- Endurance: +105°C 2,000–4,000 hours
- Suitable for switching power, UPS, power sources, etc.
- RoHS Compliant



SPECIFICATIONS

Items	Characteristics								
Category Temperature Range	-40~+105°C								
Rated Voltage Range	6.3~100 V _{dc}								
Capacitance Tolerance	±20%(M) (at 20°C, 120Hz)								
Leakage Current	I 0.01CV or 3μA, whichever is greater. Where, I:Max.leakage current (μA), C:Nominal capacitance (μF), V: Rated voltage (V) (at 20°C after 2 minutes)								
Dissipation Factor (tan δ)	Rated Voltage(V _{dc}) 6.3 10 16 25 35 50 63 100								
	tan (max.) 0.22 0.19 0.16 0.14 0.12 0.10 0.09 0.08								
When nominal capacitance exceeds 1,000μF, add 0.02 to the value above for each 1,000μF increase. (at 20°C, 120Hz)									
Low Temperature Characteristics (Max. Impedance Ratio)	Rated Voltage(V _{dc}) 6.3 10 16 25 35 50 63 100								
	Z(-25°C)/Z(+20°C) 4 3 2								
	Z(-40°C)/Z(+20°C) 8 6 4 3 (at 120Hz)								
Endurance	The following specifications listed below shall be met when the capacitors are restored to 20°C after DC voltage plus rated ripple current is applied for a specified period of time at 105 °C.								
	Capacitance Change ±25% of the initial value								
	D.F. (tan δ) 200% of the initial specified value								
	Leakage Current The initial specified value								
<table border="1"> <thead> <tr> <th>Case Dia.(mm)</th> <th>Load life (hours)</th> </tr> </thead> <tbody> <tr> <td>ØD 6.3</td> <td>2,000</td> </tr> <tr> <td>ØD=8&10</td> <td>3,000</td> </tr> <tr> <td>ØD 12.5</td> <td>4,000</td> </tr> </tbody> </table>		Case Dia.(mm)	Load life (hours)	ØD 6.3	2,000	ØD=8&10	3,000	ØD 12.5	4,000
Case Dia.(mm)	Load life (hours)								
ØD 6.3	2,000								
ØD=8&10	3,000								
ØD 12.5	4,000								
Shelf Life	The following specifications shall be satisfied when the capacitors are restored to 20°C after leaving them under no load at 105°C for 1,000 hours.								
	Capacitance Change ±25% of the initial value								
	D.F. (tan δ) 200% of the initial specified value								
	Leakage Current 200% of the initial specified value								

DIMENSIONS[mm]

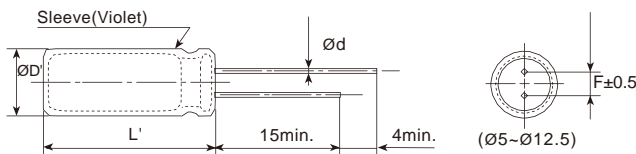

ØD	5	6.3	8	10	12.5
Ød	0.5	0.5	0.5	0.6	0.6
F	2.0	2.5	3.5	5.0	5.0
ØD'	ØD+0.5max.				
L'	L+2max.				

PART NUMBERING SYSTEM

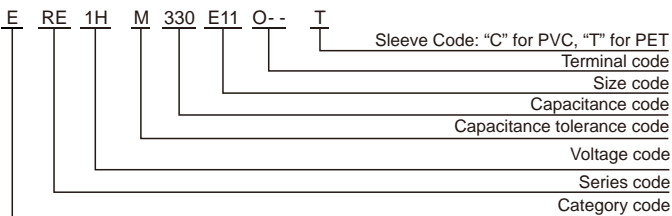

RATED RIPPLE CURRENT MULTIPLIERS

Frequency correction factor for ripple current

Freq.(Hz)	120	1k	10k	100k
Cap.<220	0.40	0.75	0.90	1.00
220 Cap.<680	0.50	0.85	0.94	1.00
680 Cap.<2200	0.60	0.87	0.95	1.00
2200 Cap.<4700	0.75	0.90	0.95	1.00
Cap. 4700	0.85	0.95	0.98	1.00

The endurance of capacitors is shortened with internal heating produced by ripple current at the rate of halving the lifetime with every 5°C rise. When long life performance is required in actual use, the rms ripple current has to be reduced.

RE series

■ STANDARD RATINGS

VV (Vdc)	Cap (μF)	Size DxL(mm)	tan	Impedance (max/20°C, 100kHz)	Rated ripple current (mArms/105°C, 100kHz)	Part Number
6.3(0J)	180	6.3x11	0.22	0.25	340	ERE0JM181E11OT
		8x9	0.22	0.33	300	ERE0JM181F09OT
	220	6.3x11	0.22	0.25	340	ERE0JM221E11OT
		8x9	0.22	0.33	300	ERE0JM221F09OT
	270	6.3x11	0.22	0.25	340	ERE0JM271E11OT
		8x9	0.22	0.33	300	ERE0JM271F09OT
	330	8x11	0.22	0.13	650	ERE0JM331F11OT
		10x9	0.22	0.17	580	ERE0JM331G09OT
	470	8x11	0.22	0.13	650	ERE0JM471F11OT
		10x9	0.22	0.17	580	ERE0JM471G09OT
	560	8x11	0.22	0.13	650	ERE0JM561F11OT
		10x9	0.22	0.17	580	ERE0JM561G09OT
	680	8x11	0.22	0.13	650	ERE0JM681F11OT
		10x9	0.22	0.17	580	ERE0JM681G09OT
	820	10x12	0.22	0.08	870	ERE0JM821G12OT
		10x9	0.22	0.17	580	ERE0JM102G09OT
	1000	10x12	0.22	0.08	870	ERE0JM102G12OT
		10x12	0.22	0.08	870	ERE0JM122G12OT
	1200	8x20	0.22	0.068	1050	ERE0JM152F20OT
		10x16	0.22	0.060	1210	ERE0JM152G16OT
	1800	10x20	0.22	0.045	1400	ERE0JM182G20OT
		10x20	0.24	0.045	1400	ERE0JM222G20OT
2200	10x25	0.24	0.042	1650	ERE0JM272G25OT	
	12.5x20	0.24	0.035	1900	ERE0JM272W20OT	
3300	10x25	0.24	0.042	1650	ERE0JM332G25OT	
	12.5x20	0.26	0.035	1900	ERE0JM332W20OT	
3900	12.5x20	0.26	0.035	1900	ERE0JM392W20OT	
	12.5x25	0.28	0.030	2130	ERE0JM472W25OT	
10(1A)	150	6.3x11	0.19	0.25	340	ERE1AM151E11OT
		8x9	0.19	0.33	300	ERE1AM151F09OT
	180	6.3x11	0.19	0.25	340	ERE1AM181E11OT
		8x9	0.19	0.33	300	ERE1AM181F09OT
	220	6.3x11	0.19	0.25	340	ERE1AM221E11OT
		8x9	0.19	0.33	300	ERE1AM221F09OT
	270	8x9	0.19	0.33	300	ERE1AM271F09OT
		10x9	0.19	0.17	580	ERE1AM271G09OT
	330	10x9	0.19	0.17	580	ERE1AM331G09OT
		10x9	0.19	0.17	580	ERE1AM471G09OT
	560	10x9	0.19	0.17	580	ERE1AM561G09OT
		10x9	0.19	0.17	580	ERE1AM681G09OT
	680	10x9	0.19	0.17	580	ERE1AM681G09OT
		8x16	0.19	0.087	850	ERE1AM102F16OT
	820	10x12	0.19	0.08	870	ERE1AM821G12OT
		10x16	0.19	0.087	850	ERE1AM102F16OT
	1000	10x16	0.19	0.060	1210	ERE1AM102G16OT
		10x20	0.19	0.045	1400	ERE1AM122G20OT
	1200	10x20	0.19	0.045	1400	ERE1AM152G20OT
		10x20	0.19	0.045	1400	ERE1AM182G20OT
	1500	10x20	0.19	0.045	1400	ERE1AM222G20OT
		10x25	0.21	0.042	1650	ERE1AM272G25OT
1800	10x20	0.21	0.045	1400	ERE1AM272G25OT	
	12.5x20	0.21	0.035	1900	ERE1AM272W20OT	
2200	10x25	0.21	0.042	1650	ERE1AM332G25OT	
	12.5x25	0.23	0.030	2130	ERE1AM332W25OT	
16(1C)	100	8x9	0.16	0.33	300	ERE1CM101F09OT
		8x9	0.16	0.33	300	ERE1CM121F09OT
	150	8x9	0.16	0.33	300	ERE1CM151F09OT
		10x9	0.16	0.33	580	ERE1CM151G09OT
	180	8x9	0.16	0.33	300	ERE1CM181F09OT
		10x9	0.16	0.33	580	ERE1CM181G09OT
	220	8x9	0.16	0.33	300	ERE1CM221F09OT
		10x9	0.16	0.33	580	ERE1CM221G09OT
	270	10x9	0.16	0.17	580	ERE1CM271G09OT
		10x9	0.16	0.17	580	ERE1CM331G09OT
	330	10x9	0.16	0.17	580	ERE1CM471G09OT
		10x9	0.16	0.17	580	ERE1CM471G09OT
	470	10x12	0.16	0.08	870	ERE1CM471G12OT
		10x12	0.16	0.08	870	ERE1CM561G12OT
	560	8x16	0.16	0.087	850	ERE1CM681F16OT
		10x12	0.16	0.080	870	ERE1CM681G12OT
	820	10x16	0.16	0.06	1210	ERE1CM821G16OT
		10x16	0.16	0.06	1210	ERE1CM102G16OT
	1000	10x20	0.16	0.045	1400	ERE1CM122G20OT
		10x20	0.16	0.045	1400	ERE1CM152G20OT
	1200	10x25	0.16	0.042	1650	ERE1CM182G25OT
		12.5x20	0.16	0.035	1900	ERE1CM182W20OT
1500	12.5x20	0.18	0.035	1900	ERE1CM222W20OT	
	12.5x20	0.18	0.030	2130	ERE1CM272W20OT	
2700	12.5x20	0.18	0.030	2130	ERE1CM272W20OT	
	12.5x25	0.20	0.030	2130	ERE1CM272W25OT	
25(1E)	82	6.3x11	0.14	0.25	340	ERE1EM820E11OT
		8x9	0.14	0.33	300	ERE1EM820F09OT
100	6.3x11	0.14	0.25	340	ERE1EM101E11OT	
	8x9	0.14	0.33	300	ERE1EM101F09OT	

VV (Vdc)	Cap (μF)	Size DxL(mm)	tan	Impedance (max/20°C, 100kHz)	Rated ripple current (mArms/105°C, 100kHz)	Part Number
25(1E)	120	8x11	0.14	0.13	650	ERE1EM121F11OT
		10x9	0.14	0.17	580	ERE1EM121G09OT
	150	8x11	0.14	0.13	650	ERE1EM151F11OT
		10x9	0.14	0.17	580	ERE1EM151G09OT
	180	8x11	0.14	0.13	650	ERE1EM181F11OT
		10x9	0.14	0.17	580	ERE1EM181G09OT
	220	8x11	0.14	0.13	650	ERE1EM221F11OT
		10x9	0.14	0.17	580	ERE1EM221G09OT
	270	10x9	0.14	0.17	580	ERE1EM271G09OT
		10x12	0.14	0.08	870	ERE1EM271G12OT
	330	10x9	0.14	0.17	580	ERE1EM331G09OT
		10x12	0.14	0.08	870	ERE1EM331G12OT
	470	8x16	0.14	0.087	840	ERE1EM471F16OT
		10x12	0.14	0.080	870	ERE1EM471G12OT
	560	10x16	0.14	0.060	1210	ERE1EM561G16OT
		10x16	0.14	0.060	1210	ERE1EM681G16OT
	680	10x16	0.14	0.060	1210	ERE1EM681G16OT
		10x20	0.14	0.045	1400	ERE1EM821G20OT
	820	10x20	0.14	0.045	1400	ERE1EM821G20OT
		10x25	0.14	0.042	1650	ERE1EM152G25OT
	1000	10x20	0.14	0.045	1400	ERE1EM122G20OT
		10x25	0.14	0.042	1650	ERE1EM152G25OT
1500	12.5x20	0.14	0.035	1900	ERE1EM152W20OT	
	12.5x25	0.14	0.030	2130	ERE1EM182W25OT	
1800	12.5x25	0.14	0.030	2130	ERE1EM182W25OT	
	12.5x25	0.14	0.030	2130	ERE1EM222W25OT	
35(1V)	47	6.3x11	0.12	0.25	340	ERE1VM470E11OT
		8x9	0.12	0.33	300	ERE1VM470F09OT
	56	6.3x11	0.12	0.25	340	ERE1VM560E11OT
		8x9	0.12	0.33	300	ERE1VM560F09OT
	68	6.3x11	0.12	0.25	340	ERE1VM680E11OT
		8x9	0.12	0.33	300	ERE1VM680F09OT
	82	8x11	0.12	0.13	650	ERE1VM820F11OT
		10x9	0.12	0.17	580	ERE1VM820G09OT
	100	8x11	0.12	0.13	650	ERE1VM101F11OT
		10x9	0.12	0.17	580	ERE1VM101G09OT
	120	8x11	0.12	0.13	650	ERE1VM121F11OT
		10x9	0.12	0.17	580	ERE1VM121G09OT
	150	8x11	0.12	0.13	650	ERE1VM151F11OT
		10x9	0.12	0.17	580	ERE1VM151G09OT
	180	10x12	0.12	0.08	870	ERE1VM181G12OT
		8x11	0.12	0.13	650	ERE1VM221F11OT
	220	10x9	0.12	0.17	580	ERE1VM221G09OT
		8x16	0.12	0.087	840	ERE1VM221F16OT
	270	10x12	0.12	0.080	870	ERE1VM221G12OT
		10x16	0.12	0.060	1210	ERE1VM271G16OT
	330	8x20	0.12	0.069	1050	ERE1VM331F20OT
		10x12	0.12	0.080	870	ERE1VM331G12OT
470	10x16	0.12	0.060	1210	ERE1VM331G16OT	
	10x16	0.12	0.060	1210	ERE1VM471G16OT	
560	10x20	0.12	0.045	1400	ERE1VM561G20OT	
	10x20	0.12	0.045	1400	ERE1VM681G20OT	
680	10x25	0.12	0.042	1650	ERE1VM821G25OT	
	12.5x20	0.12	0.035	1900	ERE1VM821W20OT	
820	12.5x20	0.12	0.035	1900	ERE1VM102W20OT	
	12.5x25	0.12	0.030	2130	ERE1VM102W25OT	
50(1H)	33	6.3x11	0.10	0.30	295	ERE1HM330E11OT
		8x9	0.10	0.40	260	ERE1HM330F09OT
	39	6.3x11	0.10	0.30	295	ERE1HM390E11OT
		8x9	0.10	0.40	260	ERE1HM390F09OT
	47	6.3x11	0.10	0.30	295	ERE1HM470E11OT
		8x9	0.10	0.40	260	ERE1HM470F09OT
	56	8x11	0.10	0.17	560	ERE1HM560F11OT
		10x9	0.10	0.23	500	ERE1HM560G09OT
	68	8x11	0.10	0.17	560	ERE1HM680F11OT
		10x9	0.10	0.23	500	ERE1HM680G09OT
	82	8x11	0.10	0.17	560	ERE1HM820F11OT
		10x9	0.10	0.23	500	ERE1HM820G09OT
	100	10x12	0.10	0.12	760	ERE1HM101G12OT
		8x16	0.10	0.12	730	ERE1HM121F16OT
	120	10x12	0.10	0.12	760	ERE1HM121G12OT
		10x16	0.10	0.084	1050	ERE1HM151G16OT
	150	10x16	0.10	0.084	1050	ERE1HM151G16OT
		8x20	0.10	0.090	1050	ERE1HM181F20OT
	180	10x16	0.10	0.084	1050	ERE1HM181G16OT
		10x16	0.10	0.084	1050	ERE1HM221G16OT
	220	10x25	0.10	0.055	1440	ERE1HM271G25OT
		12.5x20	0.10	0.045	1660	ERE1HM331W20OT
270	12.5x25	0.10	0.034	1950	ERE1HM471W25OT	
	12.5x25	0.10	0.034	1950	ERE1HM561W25OT	

Radial Type

RE series

■ STANDARD RATINGS

WV (V _{dc})	Cap (μF)	Size D×L(mm)	tan	Impedance (max/20°C, 100kHz)	Rated ripple current (mArms/105°C, 100kHz)	Part Number
63(1J)	22	6.3×11	0.09	0.95	120	ERE1JM220E11OT
		8×9	0.09	1.24	100	ERE1JM220F09OT
	27	6.3×11	0.09	0.95	120	ERE1JM270E11OT
		8×9	0.09	1.24	100	ERE1JM270F09OT
	33	6.3×11	0.09	0.95	120	ERE1JM330E11OT
		8×9	0.09	1.24	100	ERE1JM330F09OT
	39	8×11	0.09	0.51	235	ERE1JM390F11OT
		10×9	0.09	0.67	210	ERE1JM390G09OT
	47	8×11	0.09	0.51	235	ERE1JM470F11OT
		10×9	0.09	0.67	210	ERE1JM470G09OT
	56	8×11	0.09	0.51	235	ERE1JM560F11OT
		10×9	0.09	0.67	210	ERE1JM560G09OT
	68	8×11	0.09	0.51	235	ERE1JM680F11OT
		10×9	0.09	0.67	210	ERE1JM680G09OT
	82	10×12	0.09	0.34	315	ERE1JM820G12OT
		8×16	0.09	0.35	300	ERE1JM101F16OT
	100	10×12	0.09	0.34	315	ERE1JM101G12OT
		10×16	0.09	0.245	360	ERE1JM121G16OT
	150	8×20	0.09	0.265	360	ERE1JM151F20OT
	180	10×20	0.09	0.165	470	ERE1JM181G20OT
220	10×20	0.09	0.165	470	ERE1JM221G20OT	
270	12.5×20	0.09	0.125	700	ERE1JM271W20OT	
330	12.5×20	0.09	0.125	700	ERE1JM331W20OT	
390	12.5×25	0.09	0.095	930	ERE1JM391W25OT	
100(1K)	15	6.3×11	0.08	0.95	120	ERE1KM150E11OT
		8×9	0.08	1.24	100	ERE1KM150F09OT
	27	8×11	0.08	0.51	235	ERE1KM270F11OT
		10×9	0.08	0.67	210	ERE1KM270G09OT
	39	8×16	0.08	0.36	300	ERE1KM390F16OT
	47	10×12	0.08	0.34	315	ERE1KM470G12OT
	56	8×20	0.08	0.265	360	ERE1KM560F20OT
	68	10×16	0.08	0.245	360	ERE1KM680G16OT
	82	10×20	0.08	0.165	470	ERE1KM820G20OT
	100	10×20	0.08	0.165	470	ERE1KM101G20OT
	120	12.5×20	0.08	0.125	700	ERE1KM121W20OT
	180	12.5×25	0.08	0.095	930	ERE1KM181W25OT
	220	12.5×25	0.08	0.095	930	ERE1KM221W25OT

RF series

- Ultra-low impedance, high ripple current
- Endurance: +105°C 3,000~6,000 hours
- RoHS Compliant



SPECIFICATIONS

Items	Characteristics										
Category Temperature Range	-40~+105°C										
Rated Voltage Range	6.3~120 V _{dc}										
Capacitance Tolerance	±20%(M) (at 20°C, 120Hz)										
Leakage Current	I 0.01CV or 3μA, whichever is greater. Where, I:Max.leakage current (μA),C:Nominal capacitance (μF),V: Rated voltage (V) (at 20°C after 2 minutes)										
Dissipation Factor (tan δ)	Rated Voltage(V _{dc}) 6.3 10 16 25 35 50 63 80 100 120										
	tan (max.) 0.15 0.14 0.12 0.10 0.10 0.08 0.08 0.08 0.08 0.12										
When nominal capacitance exceeds 1,000μF, add 0.02 to the value above for each 1,000μF increase. (at 20°C, 120Hz)											
Low Temperature Characteristics (Max. Impedance Ratio)	Rated Voltage(V _{dc}) 6.3 10 16 25 35 50 63 80 100 120										
	Z(-25°C)/Z(+20°C) 5 4 3 3										
	Z(-40°C)/Z(+20°C) 10 8 5 4 6 (at 120Hz)										
Endurance	The following specifications shall be met when the capacitors are restored to 20°C after DC voltage plus rated ripple current is applied for a specified period of time at 105 °C.										
	Capacitance Change ±25% of the initial value										
	D.F. (tan δ) 200% of the initial specified value										
	Leakage Current The initial specified value										
<table border="1"> <thead> <tr> <th>Dia. (mm)</th> <th>Load life (hours)</th> </tr> </thead> <tbody> <tr> <td>ØD 6.3</td> <td>3,000</td> </tr> <tr> <td>ØD=8</td> <td>4,000</td> </tr> <tr> <td>ØD=10</td> <td>5,000</td> </tr> <tr> <td>ØD 12.5</td> <td>6,000</td> </tr> </tbody> </table>		Dia. (mm)	Load life (hours)	ØD 6.3	3,000	ØD=8	4,000	ØD=10	5,000	ØD 12.5	6,000
Dia. (mm)	Load life (hours)										
ØD 6.3	3,000										
ØD=8	4,000										
ØD=10	5,000										
ØD 12.5	6,000										
Shelf Life	The following specifications shall be satisfied when the capacitors are restored to 20°C after leaving them under no load at 105°C for 1,000 hours.										
	Capacitance Change ±25% of the initial value										
	D.F. (tan δ) 200% of the initial specified value										
	Leakage Current 200% of the initial specified value										

DIMENSIONS[mm]

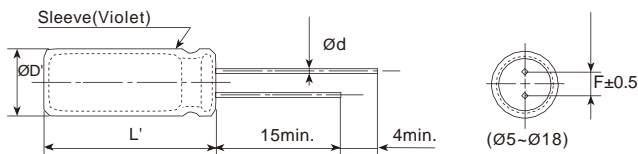

ØD	5	6.3	8	10	12.5	16	18
Ød	0.5	0.5	0.5	0.6	0.6	0.8	0.8
F	2.0	2.5	3.5	5.0	5.0	7.5	7.5
ØD'	ØD+0.5max.						
L'	L+2max.						

PART NUMBERING SYSTEM

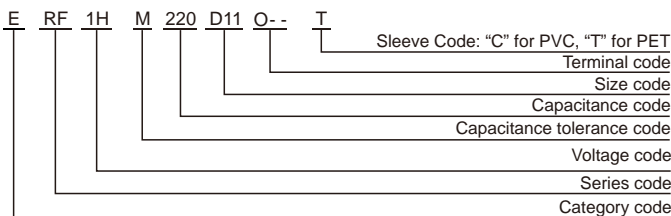

RATED RIPPLE CURRENT MULTIPLIERS

Frequency correction factor for ripple current

Freq.(Hz)	120	1k	10k	100k
Cap.<220	0.40	0.75	0.90	1.00
220 Cap.<680	0.50	0.85	0.94	1.00
680 Cap.<2200	0.60	0.87	0.95	1.00
2200 Cap.<4700	0.75	0.90	0.95	1.00
Cap. 4700	0.85	0.95	0.98	1.00

RF series

■ STANDARD RATINGS

WV (V _{dc})	Cap (μF)	Size D×L(mm)	tan	Impedance (max/20°C, 100kHz)	Rated ripple current (mA _{rms} /105°C, 100kHz)	Part Number	
6.3(0J)	150	5×11	0.15	0.29	300	ERF0JM151D11OT	
		6.3×9	0.15	0.37	270	ERF0JM151E09OT	
	220	6.3×11	0.15	0.205	377	ERF0JM221E11OT	
		8×9	0.15	0.26	337	ERF0JM221F09OT	
	330	6.3×11	0.15	0.12	455	ERF0JM331E11OT	
		8×9	0.15	0.15	408	ERF0JM331F09OT	
	470	8×11	0.15	0.09	632	ERF0JM471F11OT	
		10×9	0.15	0.12	565	ERF0JM471G09OT	
	820	8×16	0.15	0.055	1045	ERF0JM821F16OT	
	1000	8×16	0.15	0.052	1000	ERF0JM102F16OT	
	1200	8×20	0.15	0.04	1300	ERF0JM122F20OT	
		10×16	0.15	0.037	1480	ERF0JM122G16OT	
	1500	10×20	0.15	0.022	1870	ERF0JM152G20OT	
	2200	10×20	0.17	0.021	2200	ERF0JM222G20OT	
	2700	10×25	0.17	0.02	2250	ERF0JM272G25OT	
	3300	12.5×20	0.19	0.02	2410	ERF0JM332W20OT	
	3900	12.5×25	0.19	0.017	2820	ERF0JM392W25OT	
	4700	12.5×30	0.21	0.015	3340	ERF0JM472W30OT	
	5600	12.5×35	0.23	0.014	3400	ERF0JM562W35OT	
		16×20	0.23	0.017	3190	ERF0JM562L20OT	
6800	16×25	0.25	0.015	3510	ERF0JM682L25OT		
10(1A)	100	5×11	0.14	0.29	300	ERF1AM101D11OT	
		6.3×9	0.14	0.37	270	ERF1AM101E09OT	
	220	6.3×11	0.14	0.12	455	ERF1AM221E11OT	
		8×9	0.14	0.15	408	ERF1AM221F09OT	
	470	8×11	0.14	0.071	810	ERF1AM471F11OT	
		10×9	0.14	0.092	720	ERF1AM471G09OT	
	680	8×16	0.14	0.055	1046	ERF1AM681F16OT	
		10×12.5	0.14	0.052	1080	ERF1AM681G1BOT	
	1000	8×20	0.14	0.04	1300	ERF1AM102F20OT	
		10×16	0.14	0.037	1480	ERF1AM102G16OT	
	1200	10×20	0.14	0.022	1870	ERF1AM122G20OT	
	1500	10×20	0.14	0.021	2220	ERF1AM152G20OT	
	2200	12.5×20	0.16	0.02	2410	ERF1AM222W20OT	
	3300	12.5×25	0.18	0.017	2820	ERF1AM332W25OT	
	3900	12.5×30	0.18	0.015	3340	ERF1AM392W30OT	
	4700	12.5×35	0.20	0.014	3450	ERF1AM472W35OT	
	5600	16×25	0.22	0.015	3510	ERF1AM562L25OT	
	16(1C)	56	5×11	0.12	0.29	300	ERF1CM560D11OT
			6.3×9	0.12	0.37	270	ERF1CM560E09OT
		120	6.3×11	0.12	0.12	455	ERF1CM121E11OT
8×9			0.12	0.15	408	ERF1CM121F09OT	
150		6.3×11	0.12	0.096	632	ERF1CM151E11OT	
		8×9	0.12	0.12	565	ERF1CM151F09OT	
220		6.3×12	0.12	0.084	721	ERF1CM221E12OT	
		8×9	0.12	0.1	650	ERF1CM221F09OT	
330		8×11	0.12	0.071	810	ERF1CM331F11OT	
		10×9	0.12	0.092	720	ERF1CM331G09OT	
470		8×16	0.12	0.055	1045	ERF1CM471F16OT	
		10×12.5	0.12	0.052	1080	ERF1CM471G1BOT	
680		8×20	0.12	0.04	1300	ERF1CM681F20OT	
		10×16	0.12	0.04	1480	ERF1CM681G16OT	
1000		10×20	0.12	0.022	1870	ERF1CM102G20OT	
1200		10×25	0.12	0.021	2200	ERF1CM122G25OT	
1500		12.5×20	0.12	0.02	2410	ERF1CM152W20OT	
2200		12.5×25	0.14	0.017	2820	ERF1CM222W25OT	
2700		12.5×30	0.14	0.015	3340	ERF1CM272W30OT	
		16×20	0.14	0.017	3190	ERF1CM272L20OT	
3300	12.5×35	0.16	0.014	3450	ERF1CM332W35OT		
	16×25	0.16	0.016	3350	ERF1CM332L25OT		
3900	16×25	0.16	0.015	3510	ERF1CM392L25OT		

WV (V _{dc})	Cap (μF)	Size D×L(mm)	tan	Impedance (max/20°C, 100kHz)	Rated ripple current (mA _{rms} /105°C, 100kHz)	Part Number
25(1E)	47	5×11	0.10	0.29	300	ERF1EM470D11OT
		6.3×9	0.10	0.37	270	ERF1EM470E09OT
	100	6.3×11	0.10	0.12	455	ERF1EM101E11OT
		8×9	0.10	0.15	408	ERF1EM101F09OT
	220	8×11	0.10	0.071	810	ERF1EM221F11OT
		10×9	0.10	0.092	720	ERF1EM221G09OT
	330	8×16	0.10	0.055	1045	ERF1EM331F16OT
		10×12.5	0.10	0.052	1080	ERF1EM331G1BOT
	390	8×20	0.10	0.044	1236	ERF1EM391F20OT
	470	10×16	0.10	0.037	1480	ERF1EM471G16OT
	560	10×16	0.10	0.03	1675	ERF1EM561G16OT
	680	10×20	0.10	0.022	1870	ERF1EM681G20OT
	820	10×25	0.10	0.021	2200	ERF1EM821G25OT
	1000	12.5×20	0.10	0.019	2550	ERF1EM102W20OT
	1500	12.5×25	0.10	0.017	2820	ERF1EM152W25OT
	1800	12.5×30	0.10	0.015	3340	ERF1EM182W30OT
		16×20	0.10	0.017	3190	ERF1EM182L20OT
	2200	12.5×35	0.12	0.014	3450	ERF1EM222W35OT
	2700	16×25	0.12	0.015	3510	ERF1EM272L25OT
	35(1V)	33	5×11	0.10	0.29	300
6.3×9			0.10	0.37	270	ERF1VM330E09OT
56		6.3×11	0.10	0.12	455	ERF1VM560E11OT
		8×9	0.10	0.15	408	ERF1VM560F09OT
100		8×11	0.10	0.095	632	ERF1VM101F11OT
		10×9	0.10	0.12	565	ERF1VM101G09OT
150		8×11	0.10	0.071	810	ERF1VM151F11OT
		10×9	0.10	0.092	720	ERF1VM151G09OT
220		8×16	0.10	0.055	1045	ERF1VM221F16OT
		10×12.5	0.10	0.052	1080	ERF1VM221G1BOT
270		8×20	0.10	0.04	1300	ERF1VM271F20OT
330		10×16	0.10	0.037	1480	ERF1VM331G16OT
470		10×20	0.10	0.022	1870	ERF1VM471G20OT
560		10×25	0.10	0.021	2200	ERF1VM561G25OT
680		12.5×20	0.10	0.02	2410	ERF1VM681W20OT
1000		12.5×25	0.10	0.017	2820	ERF1VM102W25OT
1200		12.5×30	0.10	0.015	3340	ERF1VM122W30OT
		16×20	0.10	0.017	3190	ERF1VM122L20OT
1500		12.5×35	0.10	0.014	3450	ERF1VM152W35OT
50(1H)		22	5×11	0.08	0.33	288
	6.3×9		0.08	0.43	260	ERF1HM220E09OT
	56	6.3×11	0.08	0.13	435	ERF1HM560E11OT
		8×9	0.08	0.17	390	ERF1HM560F09OT
	100	8×11	0.08	0.073	774	ERF1HM101F11OT
		10×9	0.08	0.095	695	ERF1HM101G09OT
	120	8×16	0.08	0.06	1000	ERF1HM121F16OT
	150	10×12.5	0.08	0.06	1029	ERF1HM151G1BOT
	180	8×20	0.08	0.045	1240	ERF1HM181F20OT
	220	10×16	0.08	0.041	1420	ERF1HM221G16OT
	270	10×20	0.08	0.029	1630	ERF1HM271G20OT
	330	10×25	0.08	0.027	1920	ERF1HM331G25OT
	470	12.5×20	0.08	0.026	2100	ERF1HM471W20OT
	560	12.5×25	0.08	0.022	2460	ERF1HM561W25OT
	680	12.5×30	0.08	0.02	2910	ERF1HM681W30OT
	820	12.5×35	0.08	0.018	3010	ERF1HM821W35OT
		16×20	0.08	0.022	2780	ERF1HM821L20OT
	1000	16×25	0.08	0.02	3060	ERF1HM102L25OT

RF series

■ STANDARD RATINGS

WV (V _{dc})	Cap (μF)	Size D×L(mm)	tan	Impedance (max/20°C, 100kHz)	Rated ripple current (mA _{rms} /105°C, 100kHz)	Part Number	
63(1J)	15	5×11	0.08	0.88	165	ERF1JM150D11OT	
		6.3×9	0.08	1.14	148	ERF1JM150E09OT	
	33	6.3×11	0.08	0.35	265	ERF1JM330E11OT	
		8×9	0.08	0.45	235	ERF1JM330F09OT	
	56	8×11	0.08	0.22	500	ERF1JM560F11OT	
		10×9	0.08	0.28	450	ERF1JM560G09OT	
	82	8×16	0.08	0.16	665	ERF1JM820F16OT	
		10×12.5	0.08	0.11	690	ERF1JM820G1BOT	
	120	8×20	0.08	0.12	820	ERF1JM121F20OT	
		10×16	0.08	0.076	950	ERF1JM121G16OT	
	180	10×20	0.08	0.056	1150	ERF1JM181G20OT	
		12.5×16	0.08	0.072	1150	ERF1JM181W16OT	
	220	10×25	0.08	0.046	1350	ERF1JM221G25OT	
	270	12.5×20	0.08	0.041	1500	ERF1JM271W20OT	
	390	12.5×25	0.08	0.031	1900	ERF1JM391W25OT	
	470	12.5×30	0.08	0.028	2300	ERF1JM471W30OT	
		16×20	0.08	0.032	2000	ERF1JM471L20OT	
	560	12.5×35	0.08	0.024	2500	ERF1JM561W35OT	
		12.5×40	0.08	0.021	2800	ERF1JM681W40OT	
	680	16×25	0.08	0.025	2600	ERF1JM681L25OT	
		18×20	0.08	0.03	2500	ERF1JM681M20OT	
	820	16×30	0.08	0.021	2850	ERF1JM821L30OT	
		18×25	0.08	0.024	2800	ERF1JM821M25OT	
	1000	16×35	0.08	0.019	2900	ERF1JM102L35OT	
	1200	16×40	0.08	0.018	3400	ERF1JM122L40OT	
		18×30	0.08	0.02	3300	ERF1JM122M30OT	
	1500	18×35	0.08	0.018	3400	ERF1JM152M35OT	
	1800	18×40	0.08	0.017	3500	ERF1JM182M40OT	
80(1B)	68	10×12.5	0.08	0.17	480	ERF1BM680G1BOT	
	100	10×16	0.08	0.11	600	ERF1BM101G16OT	
	120	10×20	0.08	0.084	800	ERF1BM121G20OT	
		10×25	0.08	0.069	900	ERF1BM151G25OT	
	150	12.5×16	0.08	0.11	750	ERF1BM151W16OT	
		12.5×20	0.08	0.062	1100	ERF1BM221W20OT	
	330	12.5×25	0.08	0.047	1250	ERF1BM331W25OT	
		16×20	0.08	0.048	1350	ERF1BM331L20OT	
	390	12.5×30	0.08	0.042	1500	ERF1BM391W30OT	
		12.5×35	0.08	0.036	1650	ERF1BM471W35OT	
	470	16×25	0.08	0.038	1700	ERF1BM471L25OT	
		18×20	0.08	0.045	1500	ERF1BM471M20OT	
	560	12.5×40	0.08	0.032	1800	ERF1BM561W40OT	
	680	16×30	0.08	0.032	1850	ERF1BM681L30OT	
		18×25	0.08	0.036	1750	ERF1BM681M25OT	
	820	16×35	0.08	0.029	2000	ERF1BM821L35OT	
		18×30	0.08	0.03	1900	ERF1BM821M30OT	
	1000	16×40	0.08	0.027	2200	ERF1BM102L40OT	
	1200	18×35	0.08	0.027	2200	ERF1BM102M35OT	
			18×40	0.08	0.026	2700	ERF1BM122M40OT

WV (V _{dc})	Cap (μF)	Size D×L(mm)	tan	Impedance (max/20°C, 100kHz)	Rated ripple current (mA _{rms} /105°C, 100kHz)	Part Number
100(1K)	6.8	5×11	0.08	1.4	125	ERF1KM6R8D11OT
		6.3×9	0.08	1.8	110	ERF1KM6R8E09OT
	15	6.3×11	0.08	0.57	205	ERF1KM150E11OT
		8×9	0.08	0.74	180	ERF1KM150F09OT
	27	8×12	0.08	0.36	355	ERF1KM270F12OT
		10×9	0.08	0.47	320	ERF1KM270G09OT
	39	8×16	0.08	0.25	450	ERF1KM390F16OT
	47	10×12.5	0.08	0.17	480	ERF1KM470G1BOT
	56	8×20	0.08	0.19	565	ERF1KM560F20OT
	68	10×16	0.08	0.11	600	ERF1KM680G16OT
	82	10×20	0.08	0.084	800	ERF1KM820G20OT
	100	12.5×16	0.08	0.11	750	ERF1KM101W16OT
	120	10×25	0.08	0.069	900	ERF1KM121G25OT
	150	12.5×20	0.08	0.062	1100	ERF1KM151W20OT
	220	12.5×25	0.08	0.047	1250	ERF1KM221W25OT
	270	16×20	0.08	0.048	1350	ERF1KM221L20OT
		12.5×30	0.08	0.042	1500	ERF1KM271W30OT
	330	12.5×35	0.08	0.036	1650	ERF1KM331W35OT
		16×25	0.08	0.038	1700	ERF1KM331L25OT
	390	18×20	0.08	0.045	1500	ERF1KM331M20OT
		12.5×40	0.08	0.032	1800	ERF1KM391W40OT
	470	16×30	0.08	0.032	1850	ERF1KM471L30OT
		18×25	0.08	0.036	1750	ERF1KM471M25OT
	560	16×35	0.08	0.029	2000	ERF1KM561L35OT
		18×30	0.08	0.03	1900	ERF1KM561M30OT
	680	16×40	0.08	0.027	2200	ERF1KM681L40OT
		18×35	0.08	0.027	2200	ERF1KM681M35OT
	820	18×40	0.08	0.026	2700	ERF1KM821M40OT
120(2B)	10	6.3×11	0.12	5.5	80	ERF2BM100E11OT
	15	6.3×12	0.12	4.5	100	ERF2BM150E12OT
	18	8×9	0.12	4.0	120	ERF2BM180F09OT
	22	8×12	0.12	3.5	130	ERF2BM220F12OT
	33	8×16	0.12	3.0	220	ERF2BM330F16OT
		10×12.5	0.12	3.0	220	ERF2BM330G1BOT
	47	8×20	0.12	2.5	270	ERF2BM470F20OT
		10×16	0.12	2.5	270	ERF2BM470G16OT
	56	10×16	0.12	2.2	285	ERF2BM560G16OT
	68	10×16	0.12	2.0	285	ERF2BM680G16OT
	82	10×20	0.12	1.8	300	ERF2BM820G20OT
	100	10×25	0.12	1.5	380	ERF2BM101G25OT
	120	12.5×20	0.12	1.3	520	ERF2BM121W20OT
	150	12.5×25	0.12	1.0	570	ERF2BM151W25OT
	220	13×30	0.12	0.75	700	ERF2BM221K30OT
		16×20	0.12	0.75	700	ERF2BM221L20OT
	270	16×25	0.12	0.55	800	ERF2BM271L25OT
		18×20	0.12	0.55	800	ERF2BM271M20OT
	330	16×30	0.12	0.42	860	ERF2BM331L30OT
		18×25	0.12	0.42	860	ERF2BM331M25OT
	470	16×40	0.12	0.30	960	ERF2BM471L40OT
		18×30	0.12	0.30	960	ERF2BM471M30OT

Radial Type

RS series

- High performance, high reliability
- Low impedance, high ripple current, long life
- Endurance +105°C 4,000~10,000 hours
- RoHS Compliant



SPECIFICATIONS

Items	Characteristics										
Category Temperature Range	-40~+105°C										
Rated Voltage Range	6.3~120 V _{dc}										
Capacitance Tolerance	±20%(M) (at 20°C,120Hz)										
Leakage Current	I 0.01CV or 3μA, whichever is greater. Where, I:Max.leakage current (μA),C:Nominal capacitance (μF),V: Rated voltage (V) (at 20°C after 2 minutes)										
Dissipation Factor (tan)	Rated Voltage(V _{dc})	6.3	10	16	25	35	50	63	80	100	120
	tan (max.)	0.22	0.19	0.16	0.14	0.12	0.10	0.09	0.08	0.08	0.12
When nominal capacitance exceeds 1,000μF, add 0.02 to the value above for each 1,000μF increase. (at 20°C,120Hz)											
Low Temperature Characteristics (Max. Impedance Ratio)	Rated Voltage(V _{dc})	6.3	10	16	25	35	50	63	80	100	120
	Z(-25°C)/Z(+20°C)	4	3					2			3
	Z(-40°C)/Z(+20°C)	8	6	4				3			6
(at 120Hz)											
Endurance	The specifications listed below shall be met when the capacitors are restored to 20°C after DC voltage plus rated ripple current is applied for a specified period of time at 105 °C.										
	Capacitance Change	±20% of the initial value (6.3,10V: ±30%)						Dia. (mm)		Load life (hours)	
	D.F. (tan)	200% of the initial specified value						ØD 6.3	6.3~10V	16~120V	
	Leakage Current	The initial specified value						ØD=8&10	4,000	5,000	
Shelf Life	The following specifications shall be satisfied when the capacitors are restored to 20°C after leaving them under no load at 105°C for 1,000 hours.										
	Capacitance Change	±20% of the initial value (6.3,10V: ±30%)						ØD 12.5	6,000	7,000	
	D.F. (tan)	200% of the initial specified value							8,000	10,000	
	Leakage Current	200% of the initial specified value									

DIMENSIONS[mm]

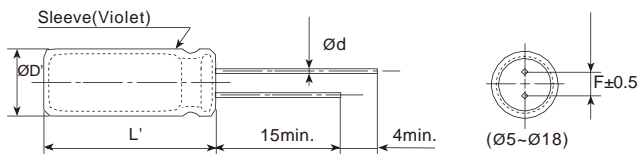

ØD	5	6.3	8	10	12.5	16	18
Ød	0.5	0.5	0.5	0.6	0.6	0.8	0.8
F	2.0	2.5	3.5	5.0	5.0	7.5	7.5
ØD'	ØD+0.5max.						
L'	L+2max.						

PART NUMBERING SYSTEM

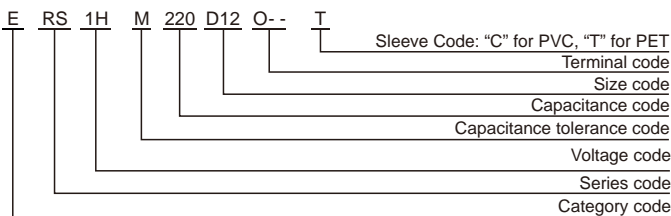

RATED RIPPLE CURRENT MULTIPLIERS

Frequency correction factor for ripple current

Cap.(μF) \ Freq.(Hz)	120	1k	10k	100k
Cap.<220	0.40	0.75	0.90	1.00
220 Cap.<680	0.50	0.85	0.94	1.00
680 Cap.<2200	0.60	0.87	0.95	1.00
2200 Cap.<4700	0.75	0.90	0.95	1.00
Cap. 4700	0.85	0.95	0.98	1.00

RS series

■ STANDARD RATINGS

WV (V _{dc})	Cap (μF)	Size D×L(mm)	tan	Impedance (max/20°C, 100kHz)	Rated ripple current (mArms/105°C, 100kHz)	Part Number
35(1V)	33	5×11	0.12	0.57	200	ERS1VM330D11OT
		6.3×9	0.12	0.74	180	ERS1VM330E09OT
	56	6.3×11	0.12	0.21	350	ERS1VM560E11OT
		8×9	0.12	0.27	310	ERS1VM560F09OT
	150	8×12	0.12	0.13	660	ERS1VM151F12OT
		10×9	0.12	0.17	590	ERS1VM151G09OT
	220	8×16	0.12	0.086	850	ERS1VM221F16OT
		10×12.5	0.12	0.08	870	ERS1VM221G1BOT
	270	8×20	0.12	0.069	1050	ERS1VM271F20OT
	330	10×16	0.12	0.06	1230	ERS1VM331G16OT
		10×20	0.12	0.046	1400	ERS1VM471G20OT
	470	12.5×16	0.12	0.049	1450	ERS1VM471W16OT
		10×25	0.12	0.042	1650	ERS1VM561G25OT
	560	10×30	0.12	0.03	1920	ERS1VM681G30OT
		12.5×20	0.12	0.035	1910	ERS1VM681W20OT
	680	16×15	0.12	0.041	1950	ERS1VM681L15OT
		12.5×25	0.12	0.026	2230	ERS1VM102W25OT
	1000	12.5×30	0.12	0.024	2650	ERS1VM122W30OT
		16×20	0.12	0.028	2247	ERS1VM122L20OT
	1200	16×25	0.12	0.027	2530	ERS1VM122L25OT
		12.5×35	0.12	0.02	2880	ERS1VM152W35OT
	1500	12.5×40	0.12	0.017	3350	ERS1VM182W40OT
		16×25	0.12	0.021	2930	ERS1VM182L25OT
	1800	18×20	0.12	0.026	2860	ERS1VM182M20OT
16×30		0.14	0.017	3450	ERS1VM222L30OT	
2200	18×25	0.14	0.019	3140	ERS1VM222M25OT	
	16×35	0.14	0.015	3610	ERS1VM272L35OT	
2700	18×30	0.14	0.015	4170	ERS1VM272M30OT	
	16×40	0.16	0.012	4100	ERS1VM332L40OT	
3300	18×35	0.16	0.014	4220	ERS1VM332M35OT	
	3900	18×40	0.16	0.011	4300	ERS1VM392M40OT
50(1H)	22	5×12	0.10	0.68	190	ERS1HM220D12OT
		6.3×9	0.10	0.89	170	ERS1HM220E09OT
	56	6.3×11	0.10	0.3	300	ERS1HM560E11OT
		8×9	0.10	0.39	270	ERS1HM560F09OT
	100	8×12	0.10	0.17	560	ERS1HM101F12OT
		10×9	0.10	0.22	500	ERS1HM101G09OT
	120	8×16	0.10	0.12	740	ERS1HM121F16OT
	150	10×12.5	0.10	0.12	760	ERS1HM151G1BOT
	180	8×20	0.10	0.09	910	ERS1HM181F20OT
	220	10×16	0.10	0.084	1050	ERS1HM221G16OT
	270	10×20	0.10	0.058	1230	ERS1HM271G20OT
		12.5×16	0.10	0.061	1260	ERS1HM271W16OT
	330	10×25	0.10	0.055	1440	ERS1HM331G25OT
		10×30	0.10	0.043	1700	ERS1HM471G30OT
	470	12.5×20	0.10	0.045	1660	ERS1HM471W20OT
		16×15	0.10	0.055	1690	ERS1HM471L15OT
	560	12.5×25	0.10	0.034	1960	ERS1HM561W25OT
	680	12.5×30	0.10	0.03	2310	ERS1HM681W30OT
	820	12.5×35	0.10	0.025	2510	ERS1HM821W35OT
		16×20	0.10	0.034	2210	ERS1HM821L20OT
	1000	12.5×40	0.10	0.021	2920	ERS1HM102W40OT
		16×25	0.10	0.025	2560	ERS1HM102L25OT
	1200	18×20	0.10	0.036	2490	ERS1HM102M20OT
		16×30	0.10	0.021	3010	ERS1HM122L30OT
	1500	18×25	0.10	0.026	2740	ERS1HM122M25OT
		16×35	0.10	0.019	3150	ERS1HM152L35OT
	1800	16×40	0.10	0.016	3710	ERS1HM182L40OT
		18×30	0.10	0.021	3640	ERS1HM182M30OT
	2200	18×35	0.12	0.017	3680	ERS1HM222M35OT
	2700	18×40	0.12	0.014	3800	ERS1HM272M40OT

WV (V _{dc})	Cap (μF)	Size D×L(mm)	tan	Impedance (max/20°C, 100kHz)	Rated ripple current (mArms/105°C, 100kHz)	Part Number
63(1J)	15	5×11	0.09	0.88	165	ERS1JM150D11OT
		6.3×9	0.09	1.15	145	ERS1JM150E09OT
	33	6.3×12	0.09	0.35	265	ERS1JM330E12OT
		8×9	0.09	0.46	235	ERS1JM330F09OT
	56	8×12	0.09	0.22	500	ERS1JM560F12OT
		10×9	0.09	0.29	440	ERS1JM560G09OT
	82	8×16	0.09	0.16	665	ERS1JM820F16OT
		10×12.5	0.09	0.11	690	ERS1JM820G1BOT
	120	8×20	0.09	0.12	820	ERS1JM121F20OT
	180	10×16	0.09	0.076	950	ERS1JM121G16OT
		10×20	0.09	0.056	1150	ERS1JM181G20OT
	220	12.5×16	0.09	0.072	1150	ERS1JM181W16OT
		10×25	0.09	0.046	1350	ERS1JM221G25OT
	330	12.5×20	0.09	0.041	1500	ERS1JM331W20OT
	390	12.5×25	0.09	0.031	1900	ERS1JM391W25OT
	470	12.5×30	0.09	0.028	2300	ERS1JM471W30OT
		16×20	0.09	0.032	2000	ERS1JM471L20OT
	560	12.5×35	0.09	0.024	2500	ERS1JM561W35OT
		12.5×40	0.09	0.021	2800	ERS1JM681W40OT
	680	16×25	0.09	0.025	2600	ERS1JM681L25OT
		18×20	0.09	0.03	2500	ERS1JM681M20OT
	820	16×30	0.09	0.021	2850	ERS1JM821L30OT
		18×25	0.09	0.024	2800	ERS1JM821M25OT
	1000	16×35	0.09	0.019	2900	ERS1JM102L35OT
1200	16×40	0.09	0.018	3400	ERS1JM122L40OT	
	18×30	0.09	0.02	3300	ERS1JM122M30OT	
1500	18×35	0.09	0.018	3400	ERS1JM152M35OT	
1800	18×40	0.09	0.017	3500	ERS1JM182M40OT	
80(1B)	68	10×12.5	0.08	0.17	480	ERS1BM680G1BOT
	100	10×16	0.08	0.11	600	ERS1BM101G16OT
		10×20	0.08	0.084	800	ERS1BM121G20OT
	150	10×25	0.08	0.069	900	ERS1BM151G25OT
		12.5×16	0.08	0.11	750	ERS1BM151W16OT
	220	12.5×20	0.08	0.062	1100	ERS1BM221W20OT
		12.5×25	0.08	0.047	1250	ERS1BM331W25OT
	330	16×20	0.08	0.048	1350	ERS1BM331L20OT
		12.5×30	0.08	0.042	1500	ERS1BM391W30OT
	390	12.5×35	0.08	0.036	1650	ERS1BM471W35OT
		16×25	0.08	0.038	1700	ERS1BM471L25OT
	470	18×20	0.08	0.045	1500	ERS1BM471M20OT
12.5×40		0.08	0.032	1800	ERS1BM561W40OT	
560	16×30	0.08	0.032	1850	ERS1BM681L30OT	
	18×25	0.08	0.036	1750	ERS1BM681M25OT	
680	16×35	0.08	0.029	2000	ERS1BM821L35OT	
	18×30	0.08	0.03	1900	ERS1BM821M30OT	
820	16×40	0.08	0.027	2200	ERS1BM102L40OT	
	18×35	0.08	0.027	2200	ERS1BM102M35OT	
1200	18×40	0.08	0.026	2700	ERS1BM122M40OT	

RS series

■ STANDARD RATINGS

WV (V _{dc})	Cap (μF)	Size D×L(mm)	tan	Impedance (max/20°C, 100kHz)	Rated ripple current (mA _{rms} /105°C, 100kHz)	Part Number
100(1K)	6.8	5×11	0.08	1.4	125	ERS1KM6R8D11OT
		6.3×9	0.08	1.9	110	ERS1KM6R8E09OT
	15	6.3×12	0.08	0.57	205	ERS1KM150E12OT
		8×9	0.08	0.75	180	ERS1KM150F09OT
	27	8×12	0.08	0.36	355	ERS1KM270F12OT
		10×9	0.08	0.45	310	ERS1KM270G09OT
	39	8×16	0.08	0.25	450	ERS1KM390F16OT
	47	10×12.5	0.08	0.17	480	ERS1KM470G1BOT
	56	8×20	0.08	0.19	565	ERS1KM560F20OT
	68	10×16	0.08	0.11	600	ERS1KM680G16OT
	82	10×20	0.08	0.084	800	ERS1KM820G20OT
	100	12.5×16	0.08	0.11	750	ERS1KM101W16OT
	120	10×25	0.08	0.069	900	ERS1KM121G25OT
	150	12.5×20	0.08	0.062	1100	ERS1KM151W20OT
	220	12.5×25	0.08	0.047	1250	ERS1KM221W25OT
		16×20	0.08	0.048	1350	ERS1KM221L20OT
	270	12.5×30	0.08	0.042	1500	ERS1KM271W30OT
		12.5×35	0.08	0.036	1650	ERS1KM271W35OT
	330	16×25	0.08	0.038	1700	ERS1KM331L25OT
		18×20	0.08	0.045	1500	ERS1KM331M20OT
	390	12.5×40	0.08	0.032	1800	ERS1KM391W40OT
	470	16×30	0.08	0.032	1850	ERS1KM471L30OT
		18×25	0.08	0.036	1750	ERS1KM471M25OT
	560	16×35	0.08	0.029	2000	ERS1KM561L35OT
		18×30	0.08	0.03	1900	ERS1KM561M30OT
	680	16×40	0.08	0.027	2200	ERS1KM681L40OT
		18×35	0.08	0.027	2200	ERS1KM681M35OT
	820	18×40	0.08	0.026	2700	ERS1KM821M40OT
120(2B)	10	6.3×11	0.12	6	85	ERS2BM100E11OT
	15	6.3×12	0.12	5	110	ERS2BM150E12OT
	18	8×9	0.12	4.5	125	ERS2BM180F09OT
	22	8×12	0.12	4	140	ERS2BM220F12OT
	33	8×16	0.12	3.5	245	ERS2BM330F16OT
		10×12.5	0.12	3.5	245	ERS2BM330G1BOT
	47	8×20	0.12	2.8	300	ERS2BM470F20OT
		10×16	0.12	2.8	315	ERS2BM470G16OT
	56	10×16	0.12	2.5	315	ERS2BM560G16OT
	68	10×16	0.12	2.2	315	ERS2BM680G16OT
	82	10×20	0.12	2	330	ERS2BM820G20OT
	100	10×25	0.12	1.7	410	ERS2BM101G25OT
	120	12.5×20	0.12	1.5	470	ERS2BM121W20OT
	150	12.5×25	0.12	1.0	620	ERS2BM151W25OT
	220	13×30	0.12	0.85	760	ERS2BM221K30OT
		16×20	0.12	0.85	760	ERS2BM221L20OT
	270	16×25	0.12	0.6	860	ERS2BM271L25OT
		18×20	0.12	0.6	860	ERS2BM271M20OT
	330	16×30	0.12	0.46	930	ERS2BM331L30OT
		18×25	0.12	0.46	930	ERS2BM331M25OT
	470	16×40	0.12	0.33	1035	ERS2BM471L40OT
		18×30	0.12	0.33	1035	ERS2BM471M30OT

RN series

- Miniaturized, high performance, high reliability
- Low impedance, high ripple current, long life
- Endurance +105°C 5,000~10,000 hours
- RoHS Compliant



SPECIFICATIONS

Items	Characteristics								
Category Temperature Range	-40~+105°C								
Rated Voltage Range	25~120 V _{dc}								
Capacitance Tolerance	±20%(M) (at 20°C, 120Hz)								
Leakage Current	I ≤ 0.01 CV or 3μA, whichever is greater. Where, I: Max. leakage current (μA), C: Nominal capacitance (μF), V: Rated voltage (V) (at 20°C after 2 minutes)								
Dissipation Factor (tan δ)	Rated Voltage(V _{dc})	25	35	50	63	80	100	120	
	tan δ (max.)	0.14	0.12	0.10	0.09	0.08	0.08	0.12	
	When nominal capacitance exceeds 1,000μF, add 0.02 to the value above for each 1,000μF increase. (at 20°C, 120Hz)								
Low Temperature Characteristics (Max. Impedance Ratio)	Rated Voltage(V _{dc})	25	35	50	63	80	100	120	
	Z(-25°C)/Z(+20°C)				2		3		
	Z(-40°C)/Z(+20°C)				4		6 (at 120Hz)		
Endurance	The specifications listed below shall be met when the capacitors are restored to 20°C after DC voltage plus rated ripple current is applied for a specified period of time at 105 °C.								
	Capacitance Change	±20% of the initial value					Dia. (mm)		Load life (hours)
	D.F. (tan δ)	200% of the initial specified value					ØD 6.3		5,000
	Leakage Current	The initial specified value					ØD=8&10		7,000
Shelf Life	The following specifications shall be satisfied when the capacitors are restored to 20°C after leaving them under no load at 105°C for 1,000 hours.								
	Capacitance Change	±20% of the initial value					ØD 12.5		10,000
	D.F. (tan δ)	200% of the initial specified value							
	Leakage Current	200% of the initial specified value							

DIMENSIONS[mm]

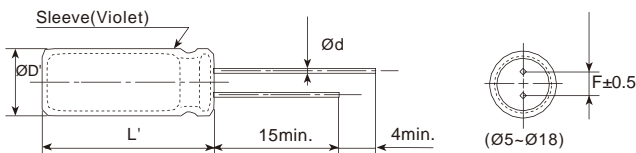

ØD	5	6.3	8	10	12.5	16	18
Ød	0.5	0.5	0.5	0.6	0.6	0.6	0.8
F	2.0	2.5	3.5	5.0	5.0	7.5	7.5
ØD'	ØD+0.5max.						
L'	L+2max.						

PART NUMBERING SYSTEM

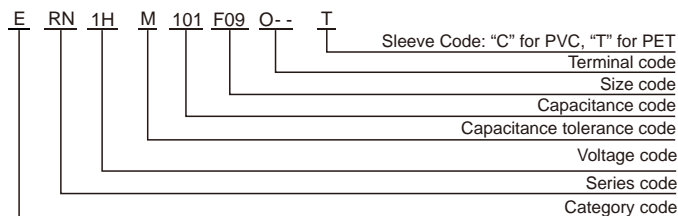

RATED RIPPLE CURRENT MULTIPLIERS

Frequency correction factor for ripple current

Cap.(μF) \ Freq.(Hz)	120	1k	10k	100k
Cap.<47	0.40	0.75	0.90	1.00
47 Cap.<330	0.50	0.85	0.94	1.00
330 Cap.<820	0.75	0.90	0.95	1.00
Cap. 820	0.85	0.95	0.98	1.00

RN series

■ STANDARD RATINGS

WV (V _{dc})	Cap (μF)	Size DxL(mm)	tan	Impedance (max/20°C, 100kHz)	Rated ripple current (mArms/105°C, 100kHz)	Part Number
25(1E)	10	5x9	0.14	3.5	80	ERN1EM100D09OT
	15	5x9	0.14	3.5	80	ERN1EM150D09OT
	22	5x9	0.14	3.5	80	ERN1EM220D09OT
	33	5x9	0.14	0.81	150	ERN1EM330D09OT
	47	5x9	0.14	0.65	180	ERN1EM470D09OT
	56	5x11	0.14	0.57	200	ERN1EM560D11OT
	68	5x11	0.14	0.57	200	ERN1EM680D11OT
		6.3x9	0.14	0.74	180	ERN1EM680E09OT
	100	5x11	0.14	0.57	200	ERN1EM101D11OT
	120	6.3x9	0.14	0.74	180	ERN1EM121E09OT
	180	6.3x11	0.14	0.21	350	ERN1EM181E11OT
		8x9	0.14	0.27	310	ERN1EM181F09OT
	220	6.3x11	0.14	0.21	350	ERN1EM221E11OT
		8x9	0.14	0.27	310	ERN1EM221F09OT
	330	8x12	0.14	0.13	660	ERN1EM331F12OT
		10x9	0.14	0.17	590	ERN1EM331G09OT
	390	8x14	0.14	0.15	885	ERN1EM391F14OT
	470	8x16	0.14	0.086	850	ERN1EM471F16OT
		10x12.5	0.14	0.08	870	ERN1EM471G1BOT
	560	8x20	0.14	0.069	1050	ERN1EM561F20OT
		10x12.5	0.14	0.08	870	ERN1EM561G1BOT
	680	8x20	0.14	0.069	1050	ERN1EM681F20OT
		10x16	0.14	0.06	1230	ERN1EM681G16OT
	820	10x16	0.14	0.06	1230	ERN1EM821G16OT
1000	10x20	0.14	0.046	1400	ERN1EM102G20OT	
1200	10x25	0.14	0.042	1650	ERN1EM122G25OT	
1500	12.5x20	0.14	0.035	1910	ERN1EM152W20OT	
35(1V)	10	5x9	0.12	3.5	80	ERN1VM100D09OT
	15	5x9	0.12	3.5	80	ERN1VM150D09OT
	22	5x9	0.12	3.5	80	ERN1VM220D09OT
	33	5x9	0.12	0.81	150	ERN1VM330D09OT
	47	5x11	0.12	0.57	200	ERN1VM470D11OT
	56	5x11	0.12	0.57	200	ERN1VM560D11OT
	68	6.3x9	0.12	0.74	180	ERN1VM680E09OT
		6.3x11	0.12	0.21	350	ERN1VM101E11OT
	100	8x9	0.12	0.27	310	ERN1VM101F09OT
		8x9	0.12	0.27	310	ERN1VM121F09OT
	180	8x12	0.12	0.13	660	ERN1VM181F12OT
		10x9	0.12	0.17	590	ERN1VM181G09OT
	220	8x12	0.12	0.13	660	ERN1VM221F12OT
		10x9	0.12	0.17	590	ERN1VM221G09OT
	330	8x16	0.12	0.086	850	ERN1VM331F16OT
		10x12.5	0.12	0.08	870	ERN1VM331G1BOT
	390	8x20	0.12	0.069	1050	ERN1VM391F20OT
		10x12.5	0.12	0.08	870	ERN1VM391G1BOT
	470	8x20	0.12	0.069	1050	ERN1VM471F20OT
		10x16	0.12	0.06	1230	ERN1VM471G16OT
	560	10x16	0.12	0.06	1230	ERN1VM561G16OT
	680	10x20	0.12	0.046	1400	ERN1VM681G20OT
		12.5x16	0.12	0.049	1450	ERN1VM681W16OT
	820	10x20	0.12	0.046	1400	ERN1VM821G20OT
12.5x16		0.12	0.049	1450	ERN1VM821W16OT	
1000	12.5x20	0.12	0.035	1910	ERN1VM102W20OT	
1200	12.5x20	0.12	0.035	1910	ERN1VM122W20OT	

WV (V _{dc})	Cap (μF)	Size DxL(mm)	tan	Impedance (max/20°C, 100kHz)	Rated ripple current (mArms/105°C, 100kHz)	Part Number
50(1H)	10	5x9	0.10	2.8	100	ERN1HM100D09OT
	15	5x9	0.10	2.8	100	ERN1HM150D09OT
	22	5x9	0.10	2.8	100	ERN1HM220D09OT
	33	5x11	0.10	0.68	190	ERN1HM330D11OT
	47	6.3x9	0.10	0.89	170	ERN1HM470E09OT
	56	6.3x11	0.10	0.3	300	ERN1HM560E11OT
		8x9	0.10	0.39	270	ERN1HM560F09OT
	68	6.3x11	0.10	0.3	300	ERN1HM680E11OT
		8x9	0.10	0.39	270	ERN1HM680F09OT
	100	8x9	0.10	0.39	270	ERN1HM101F09OT
	120	8x12	0.10	0.17	560	ERN1HM121F12OT
		10x9	0.10	0.22	500	ERN1HM121G09OT
	150	8x12	0.10	0.17	560	ERN1HM151F12OT
		10x9	0.10	0.22	500	ERN1HM151G09OT
	180	8x16	0.10	0.12	740	ERN1HM181F16OT
		10x12.5	0.10	0.12	760	ERN1HM181G1BOT
	220	8x16	0.10	0.12	740	ERN1HM221F16OT
		10x12.5	0.10	0.12	760	ERN1HM221G1BOT
	330	10x16	0.10	0.084	1050	ERN1HM331G16OT
	470	10x20	0.10	0.058	1230	ERN1HM471G20OT
	560	12.5x16	0.10	0.061	1260	ERN1HM561W16OT
	680	12.5x20	0.10	0.045	1660	ERN1HM681W20OT
	820	12.5x25	0.10	0.034	1960	ERN1HM821W25OT
	1000	12.5x30	0.10	0.03	2310	ERN1HM102W30OT
16x20		0.10	0.034	2210	ERN1HM102L20OT	
63(1J)	10	5x9	0.09	3	100	ERN1JM100D09OT
	15	5x9	0.09	3	100	ERN1JM150D09OT
	18	5x9	0.09	3	100	ERN1JM180D09OT
	22	5x11	0.09	2.2	125	ERN1JM220D11OT
	39	6.3x9	0.09	2.8	110	ERN1JM390E09OT
	47	6.3x11	0.09	0.85	200	ERN1JM470E11OT
		8x9	0.09	1.1	175	ERN1JM470F09OT
	68	8x9	0.09	1.1	175	ERN1JM680F09OT
	82	8x12	0.09	0.56	300	ERN1JM820F12OT
	100	8x12	0.09	0.5	375	ERN1JM101F12OT
	150	8x16	0.09	0.32	500	ERN1JM151F16OT
	180	10x12.5	0.09	0.22	520	ERN1JM181G1BOT
		10x16	0.09	0.18	650	ERN1JM221G16OT
	270	10x16	0.09	0.16	720	ERN1JM271G16OT
		12.5x13	0.09	0.15	780	ERN1JM271W13OT
	330	10x20	0.09	0.12	860	ERN1JM331G20OT
	390	12.5x16	0.09	0.144	860	ERN1JM391W16OT
	470	12.5x20	0.09	0.082	1120	ERN1JM471W20OT
	560	12.5x25	0.09	0.062	1420	ERN1JM561W25OT
	680	12.5x30	0.09	0.056	1730	ERN1JM681W30OT
		16x20	0.09	0.064	1500	ERN1JM681L20OT
	820	12.5x30	0.09	0.056	1730	ERN1JM821W30OT
		16x20	0.09	0.064	1500	ERN1JM821L20OT

Radial Type

RN series

■ STANDARD RATINGS

WV (V _{dc})	Cap (μF)	Size D _x L _x (mm)	tan	Impedance (max/20°C, 100kHz)	Rated ripple current (mArms/105°C, 100kHz)	Part Number
80(1B)	27	6.3x11	0.08	0.9	180	ERN1BM270E11OT
		8x9	0.08	1.2	160	ERN1BM270F09OT
	33	6.3x11	0.08	0.9	180	ERN1BM330E11OT
		8x9	0.08	1.2	160	ERN1BM330F09OT
	39	8x9	0.08	1.2	160	ERN1BM390F09OT
	47	8x12	0.08	0.65	260	ERN1BM470F12OT
		8x12	0.08	0.65	260	ERN1BM560F12OT
	56	10x9	0.08	0.85	220	ERN1BM560G09OT
		8x12	0.08	0.65	260	ERN1BM680F12OT
	68	10x9	0.08	0.85	220	ERN1BM680G09OT
		8x16	0.08	0.48	350	ERN1BM820F16OT
	82	10x12.5	0.08	0.34	380	ERN1BM820G1BOT
		8x16	0.08	0.48	350	ERN1BM101F16OT
	100	10x12.5	0.08	0.34	380	ERN1BM101G1BOT
		10x14	0.08	0.34	380	ERN1BM151G14OT
	180	10x16	0.08	0.22	480	ERN1BM181G16OT
	220	10x20	0.08	0.18	640	ERN1BM221G20OT
	330	12.5x16	0.08	0.22	600	ERN1BM221W16OT
		12.5x20	0.08	0.13	880	ERN1BM331W20OT
	390	12.5x25	0.08	0.094	1000	ERN1BM391W25OT
13x25		0.08	0.094	1000	ERN1BM471K25OT	
470	16x20	0.08	0.096	1080	ERN1BM471L20OT	
	12.5x30	0.08	0.084	1200	ERN1BM561W30OT	
560	16x25	0.08	0.076	1360	ERN1BM561L25OT	
	12.5x35	0.08	0.072	1320	ERN1BM681W35OT	
680	16x25	0.08	0.076	1360	ERN1BM681L25OT	
	2.7	5x9	0.08	4.5	80	ERN1KM2R7D09OT
3.3	5x9	0.08	3	80	ERN1KM3R3D09OT	
	4.7	5x9	0.08	3	80	ERN1KM4R7D09OT
5.6	5x11	0.08	3	80	ERN1KM5R6D11OT	
	6.8	5x11	0.08	3	80	ERN1KM6R8D11OT
10	5x11	0.08	3	80	ERN1KM100D11OT	
	6.3x9	0.08	2	70	ERN1KM150E09OT	
22	6.3x12	0.08	0.9	180	ERN1KM220E12OT	
	8x9	0.08	1.2	160	ERN1KM220F09OT	
33	8x9	0.08	1.2	160	ERN1KM330F09OT	
	8x12	0.08	0.65	260	ERN1KM470F12OT	
47	10x9	0.08	0.85	220	ERN1KM470G09OT	
	8x16	0.08	0.48	350	ERN1KM560F16OT	
56	10x12.5	0.08	0.34	380	ERN1KM560G1BOT	
	8x20	0.08	0.36	430	ERN1KM680F20OT	
68	8x20	0.08	0.36	430	ERN1KM820F20OT	
	10x12.5	0.08	0.34	380	ERN1KM820G1BOT	
100	10x16	0.08	0.22	480	ERN1KM101G16OT	
	120	10x16	0.08	0.22	480	ERN1KM121G16OT
150	10x20	0.08	0.18	640	ERN1KM151G20OT	
	12.5x16	0.08	0.22	600	ERN1KM151W16OT	
220	12.5x20	0.08	0.13	880	ERN1KM221W20OT	
	270	12.5x25	0.08	0.094	1000	ERN1KM271W25OT
330	12.5x30	0.08	0.084	1200	ERN1KM331W30OT	
	16x20	0.08	0.096	1080	ERN1KM331L20OT	
390	12.5x35	0.08	0.072	1320	ERN1KM391W35OT	
	16x25	0.08	0.076	1360	ERN1KM391L25OT	
470	16x25	0.08	0.076	1360	ERN1KM471L25OT	

WV (V _{dc})	Cap (μF)	Size D _x L _x (mm)	tan	Impedance (max/20°C, 100kHz)	Rated ripple current (mArms/105°C, 100kHz)	Part Number
100(1K)	470	18x20	0.08	0.096	1080	ERN1KM471M20OT
	560	16x30	0.08	0.064	1480	ERN1KM561L30OT
		18x25	0.08	0.072	1400	ERN1KM561M25OT
120(2B)	10	6.3x11	0.12	5.5	94	ERN2BM100E11OT
		15	6.3x12	0.12	4.5	120
	18	8x9	0.12	4.0	140	ERN2BM180F09OT
		22	8x12	0.12	3.5	154
	33	8x16	0.12	3.0	266	ERN2BM330F16OT
		10x12.5	0.12	3.0	266	ERN2BM330G1BOT
	47	8x20	0.12	2.5	320	ERN2BM470F20OT
		10x16	0.12	2.5	338	ERN2BM470G16OT
	56	10x16	0.12	2.2	338	ERN2BM560G16OT
		68	10x16	0.12	2.0	338
	82	10x20	0.12	1.8	360	ERN2BM820G20OT
		100	10x25	0.12	1.5	450
	120	12.5x20	0.12	1.3	620	ERN2BM121W20OT
		150	12.5x25	0.12	1.0	675
	220	13x30	0.12	0.75	825	ERN2BM221K30OT
		16x20	0.12	0.75	825	ERN2BM221L20OT
	270	16x25	0.12	0.55	938	ERN2BM271L25OT
18x20		0.12	0.55	938	ERN2BM271M20OT	
330	16x30	0.12	0.42	1013	ERN2BM331L30OT	
	18x25	0.12	0.42	1013	ERN2BM331M25OT	
470	16x40	0.12	0.30	1125	ERN2BM471L40OT	
	18x30	0.12	0.30	1125	ERN2BM471M30OT	

RZ series

- Miniaturized, long life, low impedance
- High ripple current, high reliability
- Endurance: +105°C 6,000~10,000 hours
- RoHS Compliant



SPECIFICATIONS

Items	Characteristics							
Category Temperature Range	-40~+105°C							
Rated Voltage Range	6.3~50 V _{dc}							
Capacitance Tolerance	±20%(M) (at 20°C, 120Hz)							
Leakage Current	I ≤ 0.01CV or 3μA, whichever is greater. Where, I: Max. leakage current (μA), C: Nominal capacitance (μF), V: Rated voltage (V) (at 20°C after 2 minutes)							
Dissipation Factor (tan δ)	Rated Voltage(V _{dc})	6.3	10	16	25	35	50	
	tan δ (max.)	0.22	0.19	0.16	0.14	0.12	0.10	
	When nominal capacitance exceeds 1,000μF, add 0.02 to the value above for each 1,000μF increase. (at 20°C, 120Hz)							
Low Temperature Characteristics (Max. Impedance Ratio)	Rated Voltage(V _{dc})	6.3	10	16~50				
	Z(-25°C)/Z(+20°C)	2						
	Z(-40°C)/Z(+20°C)	6	4	3			(at 120Hz)	
Endurance	The following specifications shall be satisfied when the capacitors are restored to 20°C after DC voltage plus the rated ripple current is applied for a specified period of time at 105 °C.							
	Capacitance Change	±25% of the initial value (6.3, 10V: ±30%)				Case Dia. (mm)		Load life (hours)
	D.F. (tan δ)	200% of the initial specified value				ØD 6.3	6,000	
	Leakage Current	The initial specified value				ØD=8	8,000	
Shelf Life	The following specifications shall be satisfied when the capacitors are restored to 20°C after exposing them for 1,000 hours at 105°C without voltage applied.							
	Capacitance Change	±25% of the initial value (6.3, 10V: ±30%)				ØD 10		10,000
	D.F. (tan δ)	200% of the initial specified value						
	Leakage Current	200% of the initial specified value						

DIMENSIONS[mm]

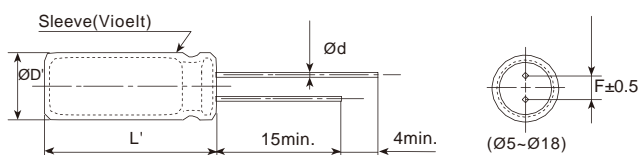

ØD	5	6.3	8	10	12.5	16	18
Ød	0.5	0.5	0.5	0.6	0.6	0.8	0.8
F	2.0	2.5	3.5	5.0	5.0	7.5	7.5
ØD'	ØD+0.5max.						
L'	L+2max.						

PART NUMBERING SYSTEM

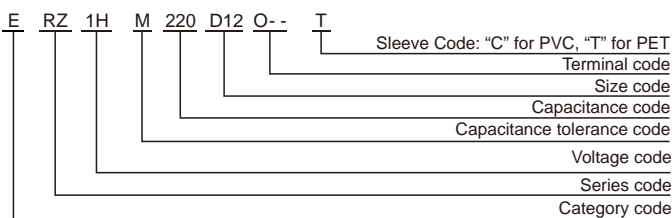

RATED RIPPLE CURRENT MULTIPLIERS

Frequency correction factor for ripple current

Cap.(μF) \ Freq.(Hz)	120	1k	10k	100k
Cap.<220	0.40	0.75	0.90	1.00
220 Cap.<680	0.50	0.85	0.94	1.00
680 Cap.<2200	0.60	0.87	0.95	1.00
2200 Cap.<4700	0.75	0.90	0.95	1.00
Cap. 4700	0.85	0.95	0.98	1.00

The endurance of capacitors is shortened with internal heating produced by ripple current at the rate of halving the lifetime with every 5°C rise. When long life performance is required in actual use, the rms ripple current has to be reduced.

RZ series

■ STANDARD RATINGS

WV (Vdc)	Cap (μF)	Size DxD(mm)	tan	Impedance (max/20°C, 100kHz)	Rated ripple current (mA _{rms} /105°C, 100kHz)	Part Number
6.3(0J)	220	5x12	0.22	0.22	345	ERZ0JM221D12OT
		6.3x9	0.22	0.30	310	ERZ0JM221E09OT
	470	6.3x12	0.22	0.094	540	ERZ0JM471E12OT
		8x9	0.22	0.120	485	ERZ0JM471F09OT
	820	8x12	0.22	0.056	945	ERZ0JM821F12OT
		10x9	0.22	0.072	850	ERZ0JM821G09OT
	1200	8x16	0.22	0.045	1250	ERZ0JM122F16OT
		10x12.5	0.22	0.039	1330	ERZ0JM122G1BOT
	1500	8x20	0.22	0.029	1500	ERZ0JM152F20OT
	1800	10x16	0.22	0.028	1760	ERZ0JM182G16OT
	2200	10x20	0.24	0.020	1960	ERZ0JM222G20OT
	2700	10x25	0.24	0.018	2250	ERZ0JM272G25OT
	3900	12.5x20	0.26	0.017	2480	ERZ0JM392W20OT
	4700	12.5x25	0.28	0.015	2900	ERZ0JM472W25OT
	5600	12.5x30	0.30	0.013	3450	ERZ0JM562W30OT
			0.32	0.012	3570	ERZ0JM682W35OT
	6800	16x20	0.32	0.015	3250	ERZ0JM682L20OT
			0.36	0.013	3630	ERZ0JM822L25OT
	10000	18x25	0.40	0.012	3650	ERZ0JM103M25OT
	10(1A)	150	5x12	0.19	0.22	345
6.3x9			0.19	0.30	310	ERZ1AM151E09OT
330		6.3x12	0.19	0.094	540	ERZ1AM331E12OT
		8x9	0.19	0.120	485	ERZ1AM331F09OT
680		8x11	0.19	0.056	945	ERZ1AM681F11OT
			0.19	0.072	850	ERZ1AM681G09OT
1000		8x16	0.19	0.045	1250	ERZ1AM102F16OT
			0.19	0.039	1330	ERZ1AM102G1BOT
1500		8x20	0.19	0.029	1500	ERZ1AM152F20OT
			0.19	0.028	1760	ERZ1AM152G16OT
1800		10x20	0.19	0.020	1960	ERZ1AM182G20OT
2200		10x25	0.21	0.018	2250	ERZ1AM222G25OT
3300		12.5x20	0.23	0.017	2480	ERZ1AM332W20OT
3900		12.5x25	0.23	0.015	2900	ERZ1AM392W25OT
4700		12.5x30	0.25	0.013	3450	ERZ1AM472W30OT
			0.25	0.015	3250	ERZ1AM472L20OT
5600		12.5x35	0.27	0.012	3570	ERZ1AM562W35OT
6800		16x25	0.29	0.013	3630	ERZ1AM682L25OT
8200		18x25	0.33	0.012	3650	ERZ1AM822M25OT
16(1C)		100	5x12	0.16	0.22	345
	6.3x9		0.16	0.30	310	ERZ1CM101E09OT
	220	6.3x12	0.16	0.094	540	ERZ1CM221E12OT
		8x9	0.16	0.120	485	ERZ1CM221F09OT
	470	8x12	0.16	0.056	945	ERZ1CM471F12OT
			0.16	0.072	850	ERZ1CM471G09OT
	680	8x16	0.16	0.045	1250	ERZ1CM681F16OT
			0.16	0.039	1330	ERZ1CM681G1BOT
	1000	8x20	0.16	0.029	1500	ERZ1CM102F20OT
			0.16	0.028	1760	ERZ1CM102G16OT
	1500	10x20	0.16	0.020	1960	ERZ1CM152G20OT
	1800	10x25	0.16	0.018	2250	ERZ1CM182G25OT
	2200	12.5x20	0.18	0.017	2480	ERZ1CM222W20OT
	2700	12.5x25	0.18	0.015	2900	ERZ1CM272W25OT
	3300	12.5x30	0.20	0.013	3450	ERZ1CM332W30OT
			0.20	0.015	3250	ERZ1CM332L20OT
	3900	12.5x35	0.20	0.012	3570	ERZ1CM392W35OT
	4700	16x25	0.22	0.013	3630	ERZ1CM472L25OT
	5600	18x25	0.24	0.012	3650	ERZ1CM562M25OT

WV (Vdc)	Cap (μF)	Size DxD(mm)	tan	Impedance (max/20°C, 100kHz)	Rated ripple current (mA _{rms} /105°C, 100kHz)	Part Number
25(1E)	68	5x12	0.14	0.22	345	ERZ1EM680D12OT
		6.3x9	0.14	0.30	310	ERZ1EM680E09OT
	150	6.3x12	0.14	0.094	540	ERZ1EM151E12OT
		8x9	0.14	0.120	485	ERZ1EM151F09OT
	330	8x12	0.14	0.056	945	ERZ1EM331F12OT
			0.14	0.072	850	ERZ1EM331G09OT
	390	8x16	0.14	0.045	1250	ERZ1EM391F16OT
			0.14	0.039	1330	ERZ1EM471G1BOT
	470	10x12.5	0.14	0.029	1500	ERZ1EM561F20OT
	560	8x20	0.14	0.029	1500	ERZ1EM561F20OT
	680	10x16	0.14	0.028	1760	ERZ1EM681G16OT
	820	10x20	0.14	0.020	1960	ERZ1EM821G20OT
	1000	10x25	0.14	0.018	2250	ERZ1EM102G25OT
			0.14	0.017	2480	ERZ1EM152W20OT
	1500	12.5x20	0.14	0.017	2480	ERZ1EM152W20OT
	1800	12.5x25	0.14	0.015	2900	ERZ1EM182W25OT
	2200	12.5x30	0.16	0.013	3450	ERZ1EM222W30OT
			0.16	0.015	3250	ERZ1EM222L20OT
	2700	12.5x35	0.16	0.012	3570	ERZ1EM272W35OT
	3300	16x25	0.18	0.013	3630	ERZ1EM332L25OT
3900	18x25	0.18	0.012	3650	ERZ1EM392M25OT	
35(1V)	47	5x12	0.12	0.33	345	ERZ1VM470D12OT
		6.3x9	0.12	0.30	310	ERZ1VM470E09OT
	100	6.3x12	0.12	0.094	540	ERZ1VM101E12OT
		8x9	0.12	0.120	485	ERZ1VM101F09OT
	220	8x16	0.12	0.056	945	ERZ1VM221F16OT
			0.12	0.045	1250	ERZ1VM271F20OT
	270	8x20	0.12	0.045	1250	ERZ1VM271F20OT
	330	10x12.5	0.12	0.039	1330	ERZ1VM331G1BOT
	390	8x20	0.12	0.029	1500	ERZ1VM391F20OT
	470	10x16	0.12	0.028	1760	ERZ1VM471G16OT
	560	10x20	0.12	0.020	1960	ERZ1VM561G20OT
	680	10x25	0.12	0.018	2250	ERZ1VM681G25OT
	1000	12.5x20	0.12	0.017	2480	ERZ1VM102W20OT
	1200	12.5x25	0.12	0.015	2900	ERZ1VM122W25OT
	1500	12.5x30	0.12	0.013	3450	ERZ1VM152W30OT
			0.12	0.015	3250	ERZ1VM152L20OT
	1800	12.5x35	0.12	0.012	3570	ERZ1VM182W35OT
	2200	16x25	0.14	0.013	3630	ERZ1VM222L25OT
	2700	18x25	0.14	0.012	3650	ERZ1VM272M25OT
	50(1H)	22	5x12	0.10	0.34	238
6.3x9			0.10	0.44	214	ERZ1HM220E09OT
56		6.3x12	0.10	0.14	385	ERZ1HM560E12OT
		8x9	0.10	0.18	345	ERZ1HM560F09OT
100		8x12	0.10	0.074	724	ERZ1HM101F12OT
			0.10	0.096	650	ERZ1HM101G09OT
120		8x16	0.10	0.061	950	ERZ1HM121F16OT
150		10x 12.5	0.10	0.061	979	ERZ1HM151G1BOT
180		8x20	0.10	0.046	1190	ERZ1HM181F20OT
220		10x16	0.10	0.042	1370	ERZ1HM221G16OT
270		10x20	0.10	0.030	1580	ERZ1HM271G20OT
330		10x25	0.10	0.028	1870	ERZ1HM331G25OT
470		12.5x20	0.10	0.027	2050	ERZ1HM471W20OT
560		12.5x25	0.10	0.023	2410	ERZ1HM561W25OT
680		12.5x30	0.10	0.021	2860	ERZ1HM681W30OT
820		12.5x35	0.10	0.019	2960	ERZ1HM821W35OT
			0.10	0.023	2730	ERZ1HM821L20OT
1000		16x25	0.10	0.021	3010	ERZ1HM102L25OT
1500		18x25	0.10	0.019	3290	ERZ1HM152M25OT

RJ series

- Miniaturized
- Low impedance, high ripple current, long life
- Endurance: +105°C 8,000 ~12,000 hours
- RoHS Compliant



SPECIFICATIONS

Items	Characteristics										
Category Temperature Range	-40~+105°C										
Rated Voltage Range	10~120 V _{dc}										
Capacitance Tolerance	±20%(M) (at 20°C, 120Hz)										
Leakage Current	I ≤ 0.01CV or 3μA, whichever is greater. Where, I: Max. leakage current (μA), C: Nominal capacitance (μF), V: Rated voltage (V) (at 20°C after 2 minutes)										
Dissipation Factor (tan δ)	Rated Voltage (V _{dc})	10	16	25	35	50	63	80	100	120	
	tan δ (max.)	0.19	0.16	0.14	0.12	0.10	0.09	0.09	0.08	0.12	
When nominal capacitance exceeds 1,000μF, add 0.02 to the value above for each 1,000μF increase. (at 20°C, 120Hz)											
Low Temperature Characteristics (Max. Impedance Ratio)	Rated Voltage (V _{dc})	10	16	25	35	50	63	80	100	120	
	Z(-25°C)/Z(+20°C)	2				2				3	
	Z(-40°C)/Z(+20°C)	4				3				6	
		(at 120Hz)									
Endurance	The specifications listed below shall be met when the capacitors are restored to 20°C after DC voltage plus rated ripple current is applied for a specified period of time at 105 °C, the peak voltage shall not exceed the rated voltage.										
	Capacitance Change	±25% of the initial value (10V: ±30%)								Case Dia. (mm)	Load life (hours)
	D.F. (tan δ)	200% of the initial specified value								ØD 6.3	10~120V 8,000
	Leakage Current	The initial specified value								ØD=8&10	10,000
										ØD 12.5	12,000
Shelf Life	The following specifications shall be satisfied when the capacitors are restored to 20°C after leaving them under no load at 105°C for 1,000 hours.										
	Capacitance Change	±25% of the initial value (10V: ±30%)									
	D.F. (tan δ)	200% of the initial specified value									
	Leakage Current	200% of the initial specified value									

DIMENSIONS [mm]

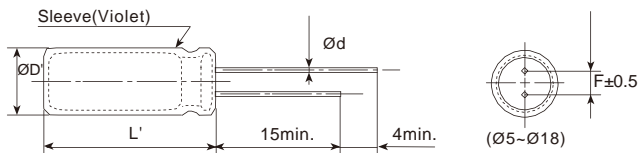

ØD	5	6.3	8	10	12.5	16	18
Ød	0.5	0.5	0.5	0.6	0.6	0.8	0.8
F	2.0	2.5	3.5	5.0	5.0	7.5	7.5
ØD'	ØD+0.5max.						
L'	L+2max.						

PART NUMBERING SYSTEM

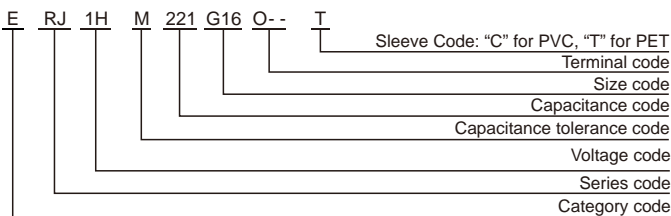

RATED RIPPLE CURRENT MULTIPLIERS

Frequency correction factor for ripple current

Freq. (Hz)	120	1k	10k	100k
Cap. < 47	0.42	0.70	0.90	1.00
47 Cap. < 330	0.50	0.73	0.92	1.00
330 Cap. < 820	0.55	0.77	0.94	1.00
820 Cap. < 2200	0.60	0.80	0.96	1.00
Cap. ≥ 2200	0.70	0.85	0.98	1.00

RJ series

■ STANDARD RATINGS

WV (V _{dc})	Cap (μF)	Size DxDL(mm)	tan	Impedance (max/20°C, 100kHz)	Rated ripple current (mA _{rms} /105°C, 100kHz)	Part Number
100(1K)	8.2	5x11	0.08	1.2	220	ERJ1KM8R2D11OT
		6.3x9	0.08	1.6	180	ERJ1KM8R2E09OT
	18	6.3x11	0.08	0.46	370	ERJ1KM180E11OT
		8x9	0.08	0.6	310	ERJ1KM180F09OT
	33	8x12	0.08	0.29	620	ERJ1KM330F12OT
		10x9	0.08	0.38	520	ERJ1KM330G09OT
	47	8x16	0.08	0.2	780	ERJ1KM470F16OT
	56	10x12.5	0.08	0.17	780	ERJ1KM560G1BOT
	68	8x20	0.08	0.16	1040	ERJ1KM680F20OT
	82	10x16	0.08	0.11	1040	ERJ1KM820G16OT
		10x20	0.08	0.084	1430	ERJ1KM101G20OT
	100	12.5x16	0.08	0.11	1430	ERJ1KM101W16OT
	120	10x25	0.08	0.069	1620	ERJ1KM121G25OT
	150	12.5x20	0.08	0.062	1750	ERJ1KM151W20OT
	220	12.5x25	0.08	0.047	2210	ERJ1KM221W25OT
		12.5x30	0.08	0.042	2400	ERJ1KM271W30OT
	270	16x20	0.08	0.048	1950	ERJ1KM271L20OT
		12.5x35	0.08	0.036	2600	ERJ1KM331W35OT
	330	12.5x40	0.08	0.032	2860	ERJ1KM391W40OT
		16x25	0.08	0.038	2430	ERJ1KM391L25OT
	390	18x20	0.08	0.045	2270	ERJ1KM391M20OT
		16x30	0.08	0.032	2640	ERJ1KM471L30OT
	470	18x25	0.08	0.036	2500	ERJ1KM471M25OT
		16x35	0.08	0.029	2860	ERJ1KM561L35OT
	560	18x30	0.08	0.03	2860	ERJ1KM561M30OT
		16x40	0.08	0.027	3510	ERJ1KM681L40OT
	680	18x35	0.08	0.027	3510	ERJ1KM681M35OT
		18x40	0.08	0.026	3860	ERJ1KM821M40OT
120(2B)	10	6.3x11	0.12	4.6	110	ERJ2BM100E11OT
		6.3x12	0.12	3.8	145	ERJ2BM150E12OT
	18	8x9	0.12	3.5	165	ERJ2BM180F09OT
	22	8x12	0.12	3.0	180	ERJ2BM220F12OT
		8x16	0.12	2.5	320	ERJ2BM330F16OT
	33	10x12.5	0.12	2.5	320	ERJ2BM330G1BOT
		8x20	0.12	2.2	385	ERJ2BM470F20OT
	47	10x16	0.12	2.0	400	ERJ2BM470G16OT
		10x16	0.12	1.9	410	ERJ2BM560G16OT
	68	10x16	0.12	1.8	420	ERJ2BM680G16OT
	82	10x20	0.12	1.6	435	ERJ2BM820G20OT
	100	10x25	0.12	1.3	540	ERJ2BM101G25OT
		120	12.5x20	0.12	1.1	750
	150	12.5x25	0.12	0.85	810	ERJ2BM151W25OT
		13x30	0.12	0.65	990	ERJ2BM221K30OT
	220	16x20	0.12	0.65	990	ERJ2BM221L20OT
		16x25	0.12	0.47	1125	ERJ2BM271L25OT
	270	18x20	0.12	0.47	1125	ERJ2BM271M20OT
		16x30	0.12	0.36	1215	ERJ2BM331L30OT
	330	18x25	0.12	0.36	1215	ERJ2BM331M25OT
		16x40	0.12	0.26	1350	ERJ2BM471L40OT
	470	18x30	0.12	0.26	1350	ERJ2BM471M30OT

RH series

- High frequency, low impedance
- Endurance +105°C 2,000~3,000 hours
- RoHS Compliant



SPECIFICATIONS

Items	Characteristics							
Category Temperature Range	-40~+105°C(160~400 V _{dc})			-25~+105°C(450 V _{dc})				
Rated Voltage Range	160~450 V _{dc}							
Capacitance Tolerance	±20%(M) (at 20°C, 120Hz)							
Leakage Current	I 0.02CV or 10μA, whichever is greater. Where, I:Max.leakage current (μA), C:Nominal capacitance (μF), V: Rated voltage (V) (at 20°C after 2 minutes)							
Dissipation Factor (tan δ)	Rated Voltage(V _{dc})	160	200	250	350	400	450	
	tan δ (max.)	0.12	0.12	0.12	0.15	0.15	0.20	
Low Temperature Characteristics (Max. Impedance Ratio)	Rated Voltage(V _{dc})	160	200	250	350	400	450	
	Z(-25°C)/Z(+20°C)	3	5			6		
	Z(-40°C)/Z(+20°C)	4	7			-		
Endurance	The following specifications shall be satisfied when the capacitors are restored to 20°C after DC voltage plus the rated ripple current is applied for a specified period of time at 105°C.							
	Capacitance Change	±20% of the initial value					Case Dia. (mm)	Load life (hours)
	D.F. (tan δ)	200% of the initial specified value					ØD 8	2,000
	Leakage Current	The initial specified value					ØD 10	3,000
Shelf Life	The following specifications shall be satisfied when the capacitors are restored to 20°C after exposing them for 1,000 hours at 105°C without voltage applied.							
	Capacitance Change	±20% of the initial value						
	D.F. (tan δ)	200% of the initial specified value						
	Leakage Current	200% of the initial specified value						

DIMENSIONS[mm]

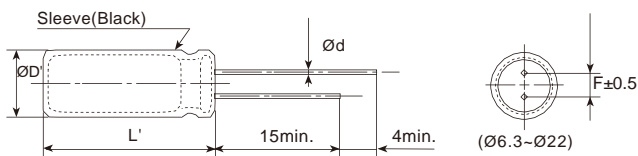

ØD	6.3	8	10	12.5	16	18	22
Ød	0.5	0.5	0.6	0.6	0.6	0.8	0.8
F	2.5	3.5	5.0	5.0	7.5	7.5	10.0
ØD'	ØD+0.5max.						
L'	L+2max.						

PART NUMBERING SYSTEM

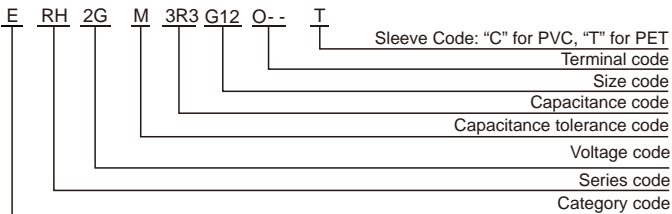

RATED RIPPLE CURRENT MULTIPLIERS

Frequency correction factor for ripple current

Freq.(Hz)	120	1k	10k	100k
Cap.<10	0.40	0.70	0.92	1.00
10 Cap.<100	0.56	0.83	0.95	1.00
100 Cap. 1000	0.67	0.87	0.96	1.00

The endurance of capacitors is shortened with internal heating produced by ripple current at the rate of halving the lifetime with every 5°C rise. When long life performance is required in actual use, the rms ripple current has to be reduced.

RH series

■ STANDARD RATINGS

WV (Vdc)	Cap (μF)	Size DxL(mm)	tan	Rated ripple current (mA _{RMS} /105°C, 100kHz)	Part Number
160(2C)	2.2	6.3x11	0.12	80	ERH2CM2R2E11OT
	3.3	6.3x11	0.12	103	ERH2CM3R3E11OT
	4.7	8x12	0.12	121	ERH2CM4R7F12OT
	10	10x12	0.12	150	ERH2CM100G12OT
	22	10x16	0.12	228	ERH2CM220G16OT
	33	10x20	0.12	293	ERH2CM330G20OT
	47	12.5x20	0.12	368	ERH2CM470W20OT
	100	12.5x25	0.12	587	ERH2CM101W25OT
220	16x30	0.12	883	ERH2CM221L30OT	
200(2D)	1	5x11	0.12	50	ERH2DM010D11OT
	2.2	6.3x11	0.12	77	ERH2DM2R2E11OT
	3.3	6.3x11	0.12	103	ERH2DM3R3E11OT
	4.7	8x12	0.12	121	ERH2DM4R7F12OT
	10	10x12	0.12	152	ERH2DM100G12OT
	22	10x16	0.12	228	ERH2DM220G16OT
		10x20	0.12	238	ERH2DM220G20OT
	33	10x20	0.12	319	ERH2DM330G20OT
		12.5x20	0.12	365	ERH2DM330W20OT
	47	12.5x20	0.12	405	ERH2DM470W20OT
	56	12.5x25	0.12	476	ERH2DM560W25OT
	68	12.5x25	0.12	540	ERH2DM680W25OT
	82	10x30	0.12	574	ERH2DM820G30OT
	100	16x25	0.12	774	ERH2DM101L25OT
	120	16x25	0.12	801	ERH2DM121L25OT
	150	18x25	0.12	908	ERH2DM151M25OT
180	12.5x35	0.12	948	ERH2DM181W35OT	
220	18x30	0.12	1032	ERH2DM221M30OT	
250(2E)	0.47	6.3x11	0.12	32	ERH2EMR47E11OT
	1	6.3x11	0.12	59	ERH2EM010E11OT
	2.2	6.3x11	0.12	77	ERH2EM2R2E11OT
	3.3	8x12	0.12	106	ERH2EM3R3F12OT
	4.7	8x12	0.12	124	ERH2EM4R7F12OT
	10	10x12	0.12	152	ERH2EM100G12OT
	22	10x20	0.12	244	ERH2EM220G20OT
	33	12.5x20	0.12	371	ERH2EM330W20OT
	47	12.5x25	0.12	423	ERH2EM470W25OT
	56	12.5x25	0.12	472	ERH2EM560W25OT
	82	16x25	0.12	637	ERH2EM820L25OT
	100	16x30	0.12	795	ERH2EM101L30OT
220	18x35	0.12	1085	ERH2EM221M35OT	
330	18x45	0.12	1182	ERH2EM331M45OT	
470	22x46	0.12	1290	ERH2EM471O46OT	
350(2V)	0.47	6.3x11	0.15	32	ERH2VMR47E11OT
	1	6.3x11	0.15	59	ERH2VM010E11OT
	2.2	8x12	0.15	80	ERH2VM2R2F12OT
	3.3	8x12	0.15	109	ERH2VM3R3F12OT
		10x12	0.15	118	ERH2VM3R3G12OT
	4.7	10x16	0.15	153	ERH2VM4R7G16OT
	10	10x16	0.15	179	ERH2VM100G16OT
	22	12.5x25	0.15	316	ERH2VM220W25OT
	33	16x25	0.15	365	ERH2VM330L25OT
	47	16x30	0.15	532	ERH2VM470L30OT

WV (Vdc)	Cap (μF)	Size DxL(mm)	tan	Rated ripple current (mA _{RMS} /105°C, 100kHz)	Part Number
400(2G)	1	8x12	0.15	59	ERH2GM010F12OT
	2.2	8x12	0.15	91	ERH2GM2R2F12OT
	3.3	8x12	0.15	125	ERH2GM3R3F12OT
		10x12	0.15	133	ERH2GM3R3G12OT
	4.7	10x12	0.15	156	ERH2GM4R7G12OT
	10	10x16	0.15	184	ERH2GM100G16OT
		10x20	0.15	211	ERH2GM100G20OT
	22	12.5x20	0.15	332	ERH2GM220W20OT
	27	10x30	0.15	426	ERH2GM270G30OT
	33	10x35	0.15	498	ERH2GM330G35OT
		16x20	0.15	487	ERH2GM330L20OT
	39	10x40	0.15	543	ERH2GM390G40OT
	47	12.5x30	0.15	659	ERH2GM470W30OT
		16x25	0.15	647	ERH2GM470L25OT
	56	10x45	0.15	725	ERH2GM560G45OT
		12.5x35	0.15	720	ERH2GM560W35OT
	68	12.5x40	0.15	902	ERH2GM680W40OT
		16x30	0.15	864	ERH2GM680L30OT
	82	12.5x40	0.15	941	ERH2GM820W40OT
		18x30	0.15	924	ERH2GM820M30OT
	100	12.5x50	0.15	956	ERH2GM101W50OT
		18x30	0.15	935	ERH2GM101M30OT
120	22x31	0.15	962	ERH2GM121O31OT	
150	12.5x60	0.15	1021	ERH2GM151W60OT	
	22x31	0.15	1010	ERH2GM151O31OT	
450(2W)	1	8x12	0.20	59	ERH2WM010F12OT
	2.2	10x12	0.20	96	ERH2WM2R2G12OT
	3.3	10x16	0.20	136	ERH2WM3R3G16OT
	4.7	10x20	0.20	159	ERH2WM4R7G20OT
	10	12.5x20	0.20	169	ERH2WM100W20OT
	18	10x30	0.20	221	ERH2WM180G30OT
	22	16x20	0.20	338	ERH2WM220L20OT
	27	10x30	0.20	426	ERH2WM270G30OT
	33	10x35	0.20	509	ERH2WM330G35OT
		16x25	0.20	504	ERH2WM330L25OT
	39	10x40	0.20	554	ERH2WM390G40OT
	47	10x45	0.20	703	ERH2WM470G45OT
		12.5x30	0.20	698	ERH2WM470W30OT
	56	18x25	0.20	686	ERH2WM470M25OT
		12.5x35	0.20	781	ERH2WM560W35OT
	68	18x25	0.20	769	ERH2WM560M25OT
		12.5x40	0.20	830	ERH2WM680W40OT
	82	18x30	0.20	808	ERH2WM680M30OT
		12.5x45	0.20	886	ERH2WM820W45OT
	100	18x30	0.20	853	ERH2WM820M30OT
		18x35	0.20	924	ERH2WM101M35OT
	120	18x40	0.20	1128	ERH2WM121M40OT
150	22x40	0.20	1354	ERH2WM151O40OT	
220	22x46	0.20	1537	ERH2WM221O46OT	

Radial Type

HH series

- High ripple current
- Endurance +105°C 2,000 hours
- RoHS Compliant



SPECIFICATIONS

Items	Characteristics			
Category Temperature Range	-40~+105°C(400 V _{dc})		-25~+105°C(420~450 V _{dc})	
Rated Voltage Range	400~450 V _{dc}			
Capacitance Tolerance	±20%(M) (at 20°C,120Hz)			
Leakage Current		After 1 minute	After 5 minutes	
	CV 1000	I 0.1CV+40μA	I 0.03CV+15μA	
	CV>1000	I 0.04CV+100μA	I 0.02CV+25μA	
	Where, I:Max.leakage current (μA), C:Nominal capacitance (μF), V: Rated voltage (V) (at 20°C)			
Dissipation Factor (tan δ)	Rated Voltage(V _{dc})	400	420	450
	tan δ (max.)	0.15	0.20	0.20
	(at 20°C,120Hz)			
Low Temperature Characteristics (Max. Impedance Ratio)	Rated Voltage(V _{dc})	400	420	450
	Z(-25°C)/Z(+20°C)	5	6	6
	Z(-40°C)/Z(+20°C)	6	-	-
	(at 120Hz)			
Endurance	The following specifications shall be satisfied when the capacitors are restored to 20°C after DC voltage plus the rated ripple current is applied for 2,000 hours at 105°C.			
	Capacitance Change	±20% of the initial value		
	D.F. (tan δ)	200% of the initial specified value		
	Leakage Current	The initial specified value		
Shelf Life	The following specifications shall be satisfied when the capacitors are restored to 20°C after exposing them for 1,000 hours at 105°C without voltage applied.			
	Capacitance Change	±20% of the initial value		
	D.F. (tan δ)	200% of the initial specified value		
	Leakage Current	200% of the initial specified value		

DIMENSIONS[mm]

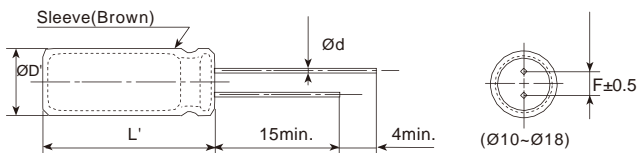

ØD	10	12.5	16	18
Ød	0.6	0.6	0.8	0.8
F	5.0	5.0	7.5	7.5
ØD'	ØD+0.5max.			
L'	L+2max.			

PART NUMBERING SYSTEM

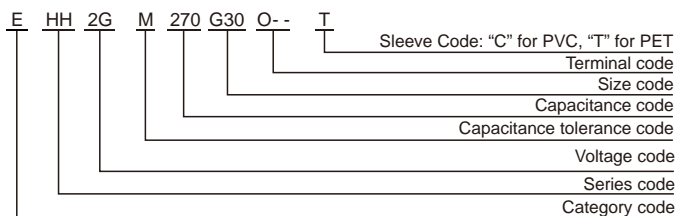

RATED RIPPLE CURRENT MULTIPLIERS

Frequency correction factor for ripple current

Freq.(Hz)	120	1k	10k	100k
Cap.(μF)				
18 Cap.<100	1.00	1.50	1.75	1.80
100 Cap. 1000	1.00	1.30	1.40	1.50

The endurance of capacitors is shortened with internal heating produced by ripple current at the rate of halving the lifetime with every 5°C rise. When long life performance is required in actual use, the rms ripple current has to be reduced.

HH series

■ STANDARD RATINGS

WV (Vdc)	Cap (µF)	Size DxL(mm)	tan	Rated ripple current (mA _{rms} /105°C, 120Hz)	Part Number
400(2G)	27	10x30	0.15	270	EHH2GM270G30OT
	33	10x30	0.15	335	EHH2GM330G30OT
	39	10x35	0.15	390	EHH2GM390G35OT
	47	10x40	0.15	445	EHH2GM470G40OT
		12.5x30	0.15	430	EHH2GM470W30OT
	56	10x45	0.15	510	EHH2GM560G45OT
		12.5x30	0.15	480	EHH2GM560W30OT
	68	10x55	0.15	560	EHH2GM680G55OT
		12.5x35	0.15	520	EHH2GM680W35OT
		12.5x40	0.15	535	EHH2GM680W40OT
	82	12.5x40	0.15	640	EHH2GM820W40OT
	100	12.5x45	0.15	730	EHH2GM101W45OT
		16x30	0.15	715	EHH2GM101L30OT
	120	12.5x55	0.15	815	EHH2GM121W55OT
		16x35	0.15	800	EHH2GM121L35OT
		18x30	0.15	800	EHH2GM121M30OT
420(2T)	27	10x30	0.20	270	EHH2TM270G30OT
	33	10x30	0.20	335	EHH2TM330G30OT
	39	10x35	0.20	390	EHH2TM390G35OT
	47	10x40	0.20	445	EHH2TM470G40OT
		12.5x30	0.20	430	EHH2TM470W30OT
	56	10x50	0.20	520	EHH2TM560G50OT
		12.5x30	0.20	485	EHH2TM560W30OT
	68	12.5x35	0.20	560	EHH2TM680W35OT
		12.5x40	0.20	570	EHH2TM680W40OT
	82	12.5x40	0.20	640	EHH2TM820W40OT
	100	12.5x50	0.20	750	EHH2TM101W50OT
		16x35	0.20	725	EHH2TM101L35OT
	120	12.5x60	0.20	825	EHH2TM121W60OT
		16x35	0.20	810	EHH2TM121L35OT
		18x30	0.20	810	EHH2TM121M30OT

WV (Vdc)	Cap (µF)	Size DxL(mm)	tan	Rated ripple current (mA _{rms} /105°C, 120Hz)	Part Number
450(2W)	22	10x30	0.20	195	EHH2WM220G30OT
	27	10x30	0.20	300	EHH2WM270G30OT
	33	10x35	0.20	350	EHH2WM330G35OT
		12.5x30	0.20	340	EHH2WM330W30OT
	39	10x40	0.20	405	EHH2WM390G40OT
		12.5x35	0.20	380	EHH2WM390W35OT
	47	10x45	0.20	460	EHH2WM470G45OT
		12.5x30	0.20	440	EHH2WM470W30OT
	56	12.5x35	0.20	505	EHH2WM560W35OT
		16x30	0.20	480	EHH2WM560L30OT
	68	12.5x40	0.20	530	EHH2WM680W40OT
		18x30	0.20	500	EHH2WM680M30OT
	82	12.5x45	0.20	660	EHH2WM820W45OT
		16x35	0.20	655	EHH2WM820L35OT
	100	12.5x55	0.20	760	EHH2WM101W55OT
		16x35	0.20	740	EHH2WM101L35OT
	120	12.5x60	0.20	835	EHH2WM121W60OT
		16x40	0.20	820	EHH2WM121L40OT
18x31		0.20	815	EHH2WM121M31OT	

HS series

- High ripple current; For power supply applications
- Endurance: +105°C 3,000–5,000 hours
- RoHS Compliant



SPECIFICATIONS

Items	Characteristics										
Category Temperature Range	-40~+105°C(160~400V _{dc})	-25~+105°C(450V _{dc})									
Rated Voltage Range	160~450 V _{dc}										
Capacitance Tolerance	±20%(M) (at 20°C,120Hz)										
Leakage Current	<table border="1"> <tr> <td></td> <td>After 1 minute</td> <td>After 5 minutes</td> </tr> <tr> <td>CV 1000</td> <td> 0.1CV+40μA</td> <td> 0.03CV+15μA</td> </tr> <tr> <td>CV>1000</td> <td> 0.04CV+100μA</td> <td> 0.02CV+25μA</td> </tr> </table>			After 1 minute	After 5 minutes	CV 1000	0.1CV+40μA	0.03CV+15μA	CV>1000	0.04CV+100μA	0.02CV+25μA
		After 1 minute	After 5 minutes								
CV 1000	0.1CV+40μA	0.03CV+15μA									
CV>1000	0.04CV+100μA	0.02CV+25μA									
		Where, I: Max. leakage current (μA), C: Nominal capacitance (μF), V: Rated voltage (V) (at 20°C)									
Dissipation Factor (tan δ)	Rated Voltage(V _{dc})	160 200 250 350 400 450									
	tan δ (max.)	0.15 0.15 0.15 0.20 0.20 0.20 (at 20°C,120Hz)									
Low Temperature Characteristics (Max. Impedance Ratio)	Rated Voltage(V _{dc})	160 200 250 350 400 450									
	Z(-25°C)/Z(+20°C)	3 3 3 6 6 6 (at 120Hz)									
	Z(-40°C)/Z(+20°C)	8 8 8 10 10 -									
Endurance	The following specifications shall be satisfied when the capacitors are restored to 20°C after DC voltage plus the rated ripple current is applied for a specified period of time at 105°C.										
	Capacitance Change	±20% of the initial value				Case Dia.(mm)	Load life (hours)				
	D.F. (tan δ)	200% of the initial specified value				ØD 8	3,000				
	Leakage Current	The initial specified value				ØD 10	5,000				
Shelf Life	The following specifications shall be satisfied when the capacitors are restored to 20°C after exposing them for 1,000 hours at 105°C without voltage applied.										
	Capacitance Change	±20% of the initial value									
	D.F. (tan δ)	200% of the initial specified value									
	Leakage Current	200% of the initial specified value									

DIMENSIONS[mm]

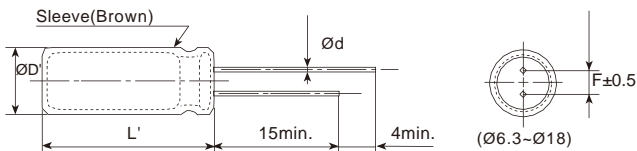

ØD	6.3	8	10	12.5	16	18
Ød	0.5	0.5	0.6	0.6	0.8	0.8
F	2.5	3.5	5.0	5.0	7.5	7.5
ØD'	ØD+0.5max.					
L'	L+2max.					

PART NUMBERING SYSTEM

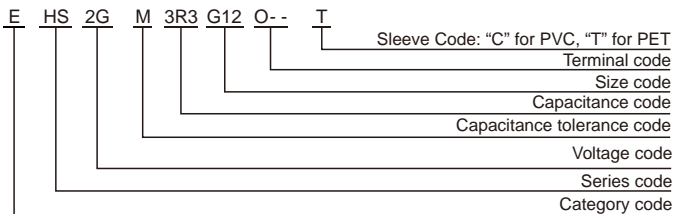

RATED RIPPLE CURRENT MULTIPLIERS

Frequency correction factor for ripple current

Cap.(μF)	Freq.(Hz)			
	120	1k	10k	100k
<100	1.0	1.75	2.25	2.50
100	1.0	1.67	2.05	2.25

The endurance of capacitors is shortened with internal heating produced by ripple current at the rate of halving the lifetime with every 5°C rise. When long life performance is required in actual use, the rms ripple current has to be reduced.

HS series

■ STANDARD RATINGS

WV (Vdc)	Cap (μF)	Size DxL(mm)	tan	Rated ripple current (mA _{rms} /105°C, 120Hz)	Part Number
160(2C)	1	6.3x12	0.15	21	EHS2CM010E12OT
	2.2	6.3x12	0.15	32	EHS2CM2R2E12OT
	3.3	6.3x12	0.15	40	EHS2CM3R3E12OT
	4.7	6.3x12	0.15	47	EHS2CM4R7E12OT
	6.8	8x12	0.15	62	EHS2CM6R8F12OT
	10	8x12	0.15	75	EHS2CM100F12OT
	15	10x16	0.15	115	EHS2CM150G16OT
	22	10x20	0.15	140	EHS2CM220G20OT
	33	10x20	0.15	175	EHS2CM330G20OT
	47	12.5x20	0.15	240	EHS2CM470W20OT
	68	12.5x25	0.15	370	EHS2CM680W25OT
	100	16x25	0.15	430	EHS2CM101L25OT
	150	16x25	0.15	500	EHS2CM151L25OT
	220	16x30	0.15	815	EHS2CM221L30OT
270	18x30	0.15	880	EHS2CM271M30OT	
330	18x40	0.15	980	EHS2CM331M40OT	
200(2D)	0.47	6.3x12	0.15	13	EHS2DMR47E12OT
	1	6.3x12	0.15	19	EHS2DM010E12OT
	2.2	6.3x12	0.15	32	EHS2DM2R2E12OT
	3.3	6.3x12	0.15	40	EHS2DM3R3E12OT
	4.7	8x12	0.15	47	EHS2DM4R7F12OT
	6.8	10x12	0.15	70	EHS2DM6R8G12OT
	10	10x12	0.15	80	EHS2DM100G12OT
	15	10x16	0.15	118	EHS2DM150G16OT
	22	10x20	0.15	140	EHS2DM220G20OT
	33	10x20	0.15	160	EHS2DM330G20OT
	47	12.5x20	0.15	250	EHS2DM470W20OT
	68	12.5x25	0.15	330	EHS2DM680W25OT
	100	16x25	0.15	440	EHS2DM101L25OT
	150	16x25	0.15	600	EHS2DM151L25OT
220	18x30	0.15	680	EHS2DM221M30OT	
270	18x40	0.15	1040	EHS2DM271M40OT	
250(2E)	0.47	6.3x12	0.15	13	EHS2EMR47E12OT
	1	6.3x12	0.15	19	EHS2EM010E12OT
	2.2	6.3x12	0.15	37	EHS2EM2R2E12OT
	3.3	8x12	0.15	50	EHS2EM3R3F12OT
	4.7	8x12	0.15	58	EHS2EM4R7F12OT
	6.8	10x12	0.15	72	EHS2EM6R8G12OT
	10	10x16	0.15	100	EHS2EM100G16OT
	15	10x16	0.15	120	EHS2EM150G16OT
	22	10x20	0.15	168	EHS2EM220G20OT
	33	12.5x20	0.15	210	EHS2EM330W20OT
	47	12.5x25	0.15	320	EHS2EM470W25OT
	68	16x25	0.15	410	EHS2EM680L25OT
	100	16x30	0.15	530	EHS2EM101L30OT
	150	18x25	0.15	550	EHS2EM151M25OT
220	18x35	0.15	710	EHS2EM221M35OT	

WV (Vdc)	Cap (μF)	Size DxL(mm)	tan	Rated ripple current (mA _{rms} /105°C, 120Hz)	Part Number
350(2V)	0.47	6.3x12	0.20	20	EHS2VMR47E12OT
	1	6.3x12	0.20	24	EHS2VM010E12OT
	2.2	8x12	0.20	40	EHS2VM2R2F12OT
	3.3	8x12	0.20	52	EHS2VM3R3F12OT
	4.7	10x12	0.20	65	EHS2VM4R7G12OT
	6.8	10x20	0.20	88	EHS2VM6R8G20OT
	10	10x20	0.20	105	EHS2VM100G20OT
	15	12.5x20	0.20	130	EHS2VM150W20OT
	22	12.5x20	0.20	182	EHS2VM220W20OT
	33	12.5x25	0.20	240	EHS2VM330W25OT
	47	16x25	0.20	305	EHS2VM470L25OT
	68	16x30	0.20	390	EHS2VM680L30OT
	100	18x30	0.20	480	EHS2VM101M30OT
	400(2G)	1	8x12	0.20	25
2.2		8x12	0.20	40	EHS2GM2R2F12OT
3.3		10x12	0.20	55	EHS2GM3R3G12OT
4.7		10x16	0.20	76	EHS2GM4R7G16OT
6.8		10x20	0.20	80	EHS2GM6R8G20OT
10		12.5x20	0.20	110	EHS2GM100W20OT
15		12.5x20	0.20	135	EHS2GM150W20OT
22		12.5x25	0.20	205	EHS2GM220W25OT
33		16x20	0.20	255	EHS2GM330L20OT
47		16x25	0.20	330	EHS2GM470L25OT
68		16x35	0.20	400	EHS2GM680L35OT
82		18x30	0.20	420	EHS2GM820M30OT
100		18x35	0.20	495	EHS2GM101M35OT
120		18x40	0.20	520	EHS2GM121M40OT
450(2W)	1	8x12	0.20	35	EHS2WM010F12OT
	2.2	10x12	0.20	40	EHS2WM2R2G12OT
	3.3	10x16	0.20	65	EHS2WM3R3G16OT
	4.7	10x16	0.20	85	EHS2WM4R7G16OT
	6.8	10x20	0.20	90	EHS2WM6R8G20OT
	10	12.5x20	0.20	140	EHS2WM100W20OT
	15	16x20	0.20	160	EHS2WM150L20OT
	22	16x25	0.20	200	EHS2WM220L25OT
	33	16x25	0.20	320	EHS2WM330L25OT
	47	18x25	0.20	350	EHS2WM470M25OT
	68	18x30	0.20	440	EHS2WM680M30OT
	82	18x35	0.20	500	EHS2WM820M35OT
	100	18x40	0.20	560	EHS2WM101M40OT

Radial Type

HF series

- Long life, high ripple current; For power supply applications
- Endurance: +105°C 5,000~10,000 hours
- RoHS Compliant



SPECIFICATIONS

Items	Characteristics							
Category Temperature Range	-40~+105°C(160~400V _{dc})			-25~+105°C(450V _{dc})				
Rated Voltage Range	160~450 V _{dc}							
Capacitance Tolerance	±20%(M) (at 20°C, 120Hz)							
Leakage Current		After 1 minute	After 5 minutes				Where, I: Max. leakage current (μA), C: Nominal capacitance (μF), V: Rated voltage (V) (at 20°C)	
	CV 1000	I 0.1CV+40μA	I 0.03CV+15μA					
	CV>1000	I 0.04CV+100μA	I 0.02CV+25μA					
Dissipation Factor (tan)	Rated Voltage(V _{dc})	160	200	250	350	400	450	
	tan (max.)	0.15	0.15	0.15	0.20	0.20	0.20	
Low Temperature Characteristics (Max. Impedance Ratio)	Rated Voltage(V _{dc})	160	200	250	350	400	450	
	Z(-25°C)/Z(+20°C)	3	3	3	6	6	6	
	Z(-40°C)/Z(+20°C)	8	8	8	10	10	-	
Endurance	The following specifications shall be satisfied when the capacitors are restored to 20°C after DC voltage plus the rated ripple current is applied for a specified period of time at 105°C.							
	Capacitance Change	±20% of the initial value					Case Dia.(mm)	Load life (hours)
	D.F. (tan)	200% of the initial specified value					ØD = 8	5,000
	Leakage Current	The initial specified value					ØD = 10	8,000
Shelf Life	The following specifications shall be satisfied when the capacitors are restored to 20°C after exposing them for 1,000 hours at 105°C without voltage applied.							
	Capacitance Change	±20% of the initial value					ØD = 12.5	10,000
	D.F. (tan)	200% of the initial specified value						
	Leakage Current	200% of the initial specified value						

DIMENSIONS[mm]

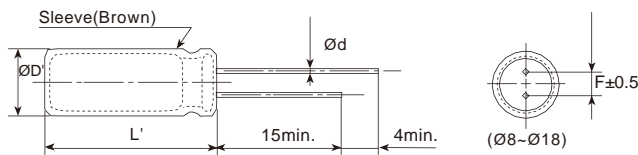

ØD	8	10	12.5	16	18
Ød	0.5	0.6	0.6	0.8	0.8
F	3.5	5.0	5.0	7.5	7.5
ØD'	ØD+0.5max.				
L'	L+2max.				

PART NUMBERING SYSTEM

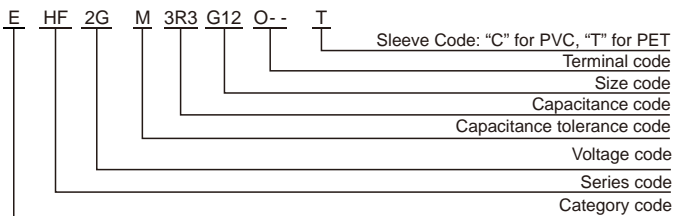

RATED RIPPLE CURRENT MULTIPLIERS

Frequency correction factor for ripple current

Cap.(μF) \ Freq.(Hz)	120	1k	10k	100k
<100	1.0	1.75	2.25	2.50
100	1.0	1.67	2.05	2.25

The endurance of capacitors is shortened with internal heating produced by ripple current at the rate of halving the lifetime with every 5°C rise. When long life performance is required in actual use, the rms ripple current has to be reduced.

HF series

■ STANDARD RATINGS

WV (Vdc)	Cap (μF)	Size DxDL(mm)	tan	Rated ripple current (mArms/105°C, 120Hz)	Part Number
160(2C)	10	10x16	0.15	128	EHF2CM100G16OT
	12	10x16	0.15	145	EHF2CM120G16OT
	15	10x20	0.15	175	EHF2CM150G20OT
	22	10x20	0.15	205	EHF2CM220G20OT
	33	10x20	0.15	250	EHF2CM330G20OT
	39	10x20	0.15	275	EHF2CM390G20OT
	47	10x20	0.15	300	EHF2CM470G20OT
		12.5x20	0.15	310	EHF2CM470W20OT
	56	12.5x20	0.15	350	EHF2CM560W20OT
	68	12.5x20	0.15	478	EHF2CM680W20OT
	82	12.5x20	0.15	510	EHF2CM820W20OT
		16x20	0.15	525	EHF2CM820L20OT
	100	12.5x25	0.15	630	EHF2CM101W25OT
		16x20	0.15	635	EHF2CM101L20OT
	150	16x20	0.15	770	EHF2CM151L20OT
		16x25	0.15	790	EHF2CM151L25OT
220	16x25	0.15	1020	EHF2CM221L25OT	
	18x25	0.15	1045	EHF2CM221M25OT	
330	18x30	0.15	1402	EHF2CM331M30OT	
200(2D)	10	10x16	0.15	126	EHF2DM100G16OT
	12	10x16	0.15	140	EHF2DM120G16OT
	15	10x20	0.15	170	EHF2DM150G20OT
	22	10x20	0.15	205	EHF2DM220G20OT
	33	10x20	0.15	255	EHF2DM330G20OT
		12.5x20	0.15	265	EHF2DM330W20OT
	39	12.5x20	0.15	310	EHF2DM390W20OT
	47	12.5x20	0.15	392	EHF2DM470W20OT
	68	12.5x20	0.15	470	EHF2DM680W20OT
		12.5x25	0.15	485	EHF2DM680W25OT
	82	16x20	0.15	554	EHF2DM820L20OT
	100	16x20	0.15	632	EHF2DM101L20OT
		16x25	0.15	655	EHF2DM101L25OT
	150	16x25	0.15	840	EHF2DM151L25OT
		16x30	0.15	865	EHF2DM151L30OT
	220	18x25	0.15	870	EHF2DM151M25OT
18x30		0.15	1050	EHF2DM221M25OT	
330	18x35	0.15	1080	EHF2DM221M30OT	
	18x40	0.15	1430	EHF2DM331M35OT	
250(2E)	4.7	8x12	0.15	70	EHF2EM4R7F12OT
	5.6	10x12	0.15	85	EHF2EM5R6G12OT
	6.8	10x12	0.15	110	EHF2EM6R8G12OT
	10	10x20	0.15	140	EHF2EM100G20OT
	22	10x20	0.15	205	EHF2EM220G20OT
	33	12.5x20	0.15	325	EHF2EM330W20OT
	39	12.5x20	0.15	345	EHF2EM390W20OT
	47	12.5x20	0.15	390	EHF2EM470W20OT
		12.5x25	0.15	405	EHF2EM470W25OT
	68	16x20	0.15	528	EHF2EM680L20OT
		16x20	0.15	550	EHF2EM820L20OT
	82	16x30	0.15	570	EHF2EM820L30OT
		16x25	0.15	680	EHF2EM101L25OT
	100	18x25	0.15	700	EHF2EM101M25OT
		18x25	0.15	866	EHF2EM151M25OT
	220	18x31	0.15	1130	EHF2EM221M31OT
18x40		0.15	1160	EHF2EM221M40OT	

WV (Vdc)	Cap (μF)	Size DxDL(mm)	tan	Rated ripple current (mArms/105°C, 120Hz)	Part Number
350(2V)	4.7	10x12	0.20	70	EHF2VM4R7G12OT
	5.6	10x12	0.20	90	EHF2VM5R6G12OT
	6.8	10x16	0.20	112	EHF2VM6R8G16OT
	10	10x20	0.20	140	EHF2VM100G20OT
	22	12.5x20	0.20	265	EHF2VM220W20OT
	33	16x20	0.20	364	EHF2VM330L20OT
	39	16x20	0.20	385	EHF2VM390L20OT
		16x20	0.20	430	EHF2VM470L20OT
	47	16x25	0.20	445	EHF2VM470L25OT
		16x25	0.20	560	EHF2VM680L25OT
	68	18x20	0.20	550	EHF2VM680M20OT
		18x25	0.20	570	EHF2VM680M25OT
	82	18x25	0.20	618	EHF2VM820M25OT
	100	18x25	0.20	700	EHF2VM101M25OT
		18x30	0.20	725	EHF2VM101M30OT
	120	18x30	0.20	836	EHF2VM121M30OT
150	18x35	0.20	970	EHF2VM151M35OT	
400(2G)	1	8x12	0.20	30	EHF2GM010F12OT
	2.2	8x12	0.20	45	EHF2GM2R2F12OT
	3.3	10x12	0.20	80	EHF2GM3R3G12OT
	4.7	10x16	0.20	100	EHF2GM4R7G16OT
	6.8	10x16	0.20	112	EHF2GM6R8G16OT
	10	10x20	0.20	144	EHF2GM100G20OT
	15	12.5x20	0.20	222	EHF2GM150W20OT
	22	12.5x20	0.20	260	EHF2GM220W20OT
		12.5x25	0.20	275	EHF2GM220W25OT
	33	16x20	0.20	368	EHF2GM330L20OT
	39	16x25	0.20	410	EHF2GM390L25OT
		16x25	0.20	470	EHF2GM470L25OT
	47	18x20	0.20	455	EHF2GM470M20OT
		16x30	0.20	480	EHF2GM470L30OT
	56	10x50	0.20	520	EHF2GM560G50OT
		12.5x40	0.20	600	EHF2GM680W40OT
68	18x25	0.20	590	EHF2GM680M25OT	
	12.5x45	0.20	625	EHF2GM820W45OT	
82	18x25	0.20	610	EHF2GM820M25OT	
	18x30	0.20	630	EHF2GM820M30OT	
100	12.5x50	0.20	790	EHF2GM101W50OT	
	18x31	0.20	765	EHF2GM101M31OT	
120	18x35	0.20	785	EHF2GM101M35OT	
	18x35	0.20	870	EHF2GM121M35OT	
150	18x40	0.20	985	EHF2GM151M40OT	
450(2W)	6.8	10x20	0.20	112	EHF2WM6R8G20OT
	10	12.5x20	0.20	185	EHF2WM100W20OT
	15	12.5x25	0.20	248	EHF2WM150W25OT
	22	16x20	0.20	295	EHF2WM220L20OT
	33	10x40	0.20	405	EHF2WM330G40OT
		16x25	0.20	398	EHF2WM330L25OT
	39	18x20	0.20	385	EHF2WM330M20OT
		10x45	0.20	425	EHF2WM390G45OT
	47	18x25	0.20	415	EHF2WM390M25OT
		12.5x40	0.20	505	EHF2WM470W40OT
	56	18x25	0.20	496	EHF2WM470M25OT
		12.5x40	0.20	550	EHF2WM560W40OT
	68	18x30	0.20	640	EHF2WM680M30OT
	82	12.5x50	0.20	730	EHF2WM820W50OT
		18x35	0.20	720	EHF2WM820M35OT
	100	18x40	0.20	808	EHF2WM101M40OT

Radial Type

HL series

- Long life, downsized, high ripple current; For power supply applications
- Endurance: +105°C 8,000~12,000 hours
- RoHS Compliant



SPECIFICATIONS

Items	Characteristics										
Category Temperature Range	-40~+105°C(160~400V _{dc})	-25~+105°C(450~500V _{dc})									
Rated Voltage Range	160~500 V _{dc}										
Capacitance Tolerance	±20%(M) (at 20°C, 120Hz)										
Leakage Current	<table border="1"> <tr> <td></td> <td>After 1 minute</td> <td>After 5 minutes</td> </tr> <tr> <td>CV 1000</td> <td>I 0.1CV+40μA</td> <td>I 0.03CV+15μA</td> </tr> <tr> <td>CV>1000</td> <td>I 0.04CV+100μA</td> <td>I 0.02CV+25μA</td> </tr> </table>			After 1 minute	After 5 minutes	CV 1000	I 0.1CV+40μA	I 0.03CV+15μA	CV>1000	I 0.04CV+100μA	I 0.02CV+25μA
		After 1 minute	After 5 minutes								
CV 1000	I 0.1CV+40μA	I 0.03CV+15μA									
CV>1000	I 0.04CV+100μA	I 0.02CV+25μA									
Where, I: Max. leakage current (μA), C: Nominal capacitance (μF), V: Rated voltage (V) (at 20°C)											
Dissipation Factor (tan δ)	Rated Voltage(V _{dc})	160 200 250 350 400 450 500									
	tan (max.)	0.18 0.18 0.18 0.24 0.24 0.24 0.24 (at 20°C, 120Hz)									
Low Temperature Characteristics (Max. Impedance Ratio)	Rated Voltage(V _{dc})	160 200 250 350 400 450 500									
	Z(-25°C)/Z(+20°C)	3 3 3 6 6 6 6 (at 120Hz)									
	Z(-40°C)/Z(+20°C)	8 8 8 10 10 - -									
Endurance	The following specifications shall be satisfied when the capacitors are restored to 20°C after DC voltage plus the rated ripple current is applied for a specified period of time at 105°C.										
	Capacitance Change	±20% of the initial value			Rated Voltage	160 to 450V _{dc} 500V _{dc}					
	D.F. (tan δ)	200% of the initial specified value			Life time	L 20: 10,000 hours 10: 8,000 hours					
	Leakage Current	The initial specified value				L>20: 12,000 hours 12.5: 10,000 hours					
Shelf Life	The following specifications shall be satisfied when the capacitors are restored to 20°C after exposing them for 1,000 hours at 105°C without voltage applied.										
	Capacitance Change	±20% of the initial value									
	D.F. (tan δ)	200% of the initial specified value									
	Leakage Current	200% of the initial specified value									

DIMENSIONS[mm]

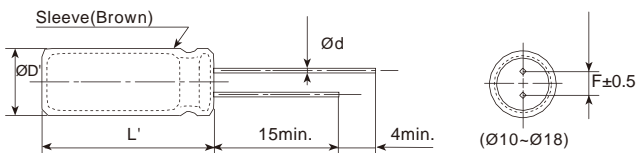

ØD	10	12.5	16	18
Ød	0.6	0.6	0.8	0.8
F	5.0	5.0	7.5	7.5
ØD'	ØD+0.5max.			
L'	L+2max.			

PART NUMBERING SYSTEM

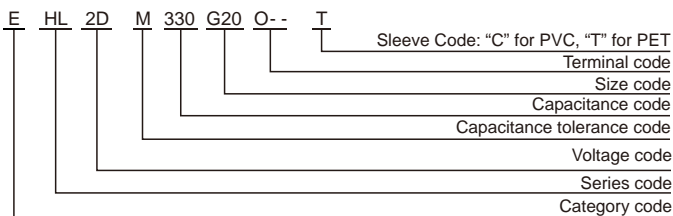

RATED RIPPLE CURRENT MULTIPLIERS

Frequency correction factor for ripple current

Freq.(Hz)	120	1k	10k	100k
Cap.(μF)				
<100	1.0	1.75	2.25	2.50
100	1.0	1.67	2.05	2.25

The endurance of capacitors is shortened with internal heating produced by ripple current at the rate of halving the lifetime with every 5°C rise. When long life performance is required in actual use, the rms ripple current has to be reduced.

HL series

■ STANDARD RATINGS

WV (Vdc)	Cap (μF)	Size DxL(mm)	tan	Rated ripple current (mA _{RMS} /105°C, 120Hz)	Part Number
160(2C)	33	10x16	0.18	210	EHL2CM330G16OT
	47	10x20	0.18	300	EHL2CM470G20OT
	56	10x20	0.18	318	EHL2CM560G20OT
	68	10x25	0.18	345	EHL2CM680G25OT
	82	10x25	0.18	416	EHL2CM820G25OT
		10x30	0.18	448	EHL2CM820G30OT
	100	12.5x20	0.18	575	EHL2CM101W20OT
	120	10x35	0.18	572	EHL2CM121G35OT
		10x40	0.18	668	EHL2CM151G40OT
	150	10x45	0.18	696	EHL2CM151G45OT
		12.5x25	0.18	767	EHL2CM151W25OT
	180	10x50	0.18	788	EHL2CM181G50OT
		12.5x30	0.18	885	EHL2CM181W30OT
		16x20	0.18	858	EHL2CM181L20OT
	220	12.5x35	0.18	1044	EHL2CM221W35OT
		16x25	0.18	1022	EHL2CM221L25OT
		18x20	0.18	992	EHL2CM221M20OT
	270	12.5x40	0.18	1196	EHL2CM271W40OT
		12.5x45	0.18	1230	EHL2CM271W45OT
	330	12.5x50	0.18	1404	EHL2CM331W50OT
		16x30	0.18	1355	EHL2CM331L30OT
		18x25	0.18	1292	EHL2CM331M25OT
	390	16x35	0.18	1505	EHL2CM391L35OT
		16x40	0.18	1708	EHL2CM471L40OT
	470	16x45	0.18	1730	EHL2CM471L45OT
		18x30	0.18	1665	EHL2CM471M30OT
		18x35	0.18	1722	EHL2CM471M35OT
	560	16x50	0.18	1924	EHL2CM561L50OT
		18x40	0.18	1910	EHL2CM561M40OT
	680	18x45	0.18	2135	EHL2CM681M45OT
		18x50	0.18	2148	EHL2CM681M50OT
	200(2D)	33	10x20	0.18	255
39		10x20	0.18	268	EHL2DM390G20OT
47		10x20	0.18	302	EHL2DM470G20OT
56		10x25	0.18	346	EHL2DM560G25OT
68		10x30	0.18	406	EHL2DM680G30OT
82		12.5x20	0.18	522	EHL2DM820W20OT
100		10x35	0.18	520	EHL2DM101G35OT
		12.5x25	0.18	628	EHL2DM101W25OT
120		10x40	0.18	595	EHL2DM121G40OT
		10x45	0.18	624	EHL2DM121G45OT
		12.5x30	0.18	728	EHL2DM121W30OT
150		16x20	0.18	698	EHL2DM121L20OT
		10x50	0.18	720	EHL2DM151G50OT
180		12.5x35	0.18	862	EHL2DM151W35OT
		16x25	0.18	928	EHL2DM181L25OT
		18x20	0.18	895	EHL2DM181M20OT
220		12.5x40	0.18	1078	EHL2DM221W40OT
		12.5x45	0.18	1116	EHL2DM221W45OT
		18x25	0.18	1050	EHL2DM221M25OT
270		12.5x50	0.18	1268	EHL2DM271W50OT
		16x30	0.18	1225	EHL2DM271L30OT
		16x35	0.18	1252	EHL2DM271L35OT
330		16x40	0.18	1428	EHL2DM331L40OT
		18x30	0.18	1402	EHL2DM331M30OT
390		16x45	0.18	1575	EHL2DM391L45OT
		18x35	0.18	1570	EHL2DM391M35OT
470		16x50	0.18	1762	EHL2DM471L50OT
		18x40	0.18	1748	EHL2DM471M40OT
		18x45	0.18	1775	EHL2DM471M45OT
560		18x50	0.18	1952	EHL2DM561M50OT

WV (Vdc)	Cap (μF)	Size DxL(mm)	tan	Rated ripple current (mA _{RMS} /105°C, 120Hz)	Part Number	
250(2E)	27	10x20	0.18	205	EHL2EM270G20OT	
	33	10x20	0.18	242	EHL2EM330G20OT	
	47	10x25	0.18	316	EHL2EM470G25OT	
		10x30	0.18	342	EHL2EM470G30OT	
	56	12.5x20	0.18	430	EHL2EM560W20OT	
	68	10x35	0.18	432	EHL2EM680G35OT	
		10x40	0.18	495	EHL2EM820G40OT	
		10x45	0.18	518	EHL2EM820G45OT	
	82	12.5x25	0.18	565	EHL2EM820W25OT	
		12.5x30	0.18	575	EHL2EM820W30OT	
		10x50	0.18	586	EHL2EM101G50OT	
	100	12.5x30	0.18	662	EHL2EM101W30OT	
		16x20	0.18	638	EHL2EM101L20OT	
	120	12.5x35	0.18	770	EHL2EM121W35OT	
		16x25	0.18	758	EHL2EM121L25OT	
		18x20	0.18	732	EHL2EM121M20OT	
	150	12.5x40	0.18	892	EHL2EM151W40OT	
		12.5x45	0.18	922	EHL2EM151W45OT	
	180	12.5x50	0.18	1040	EHL2EM181W50OT	
		16x30	0.18	995	EHL2EM181L30OT	
		18x25	0.18	955	EHL2EM181M25OT	
	220	16x35	0.18	1130	EHL2EM221L35OT	
		18x30	0.18	1138	EHL2EM221M30OT	
	270	16x40	0.18	1290	EHL2EM271L40OT	
		16x45	0.18	1315	EHL2EM271L45OT	
	330	18x35	0.18	1300	EHL2EM271M35OT	
		16x50	0.18	1480	EHL2EM331L50OT	
		18x40	0.18	1466	EHL2EM331M40OT	
	390	18x45	0.18	1488	EHL2EM331M45OT	
		18x50	0.18	1630	EHL2EM391M50OT	
	350(2V)	15	10x16	0.24	150	EHL2VM150G16OT
		18	10x20	0.24	165	EHL2VM180G20OT
22		10x20	0.24	200	EHL2VM220G20OT	
27		10x25	0.24	242	EHL2VM270G25OT	
		10x30	0.24	256	EHL2VM270G30OT	
33		12.5x20	0.24	332	EHL2VM330W20OT	
39		10x35	0.24	326	EHL2VM390G35OT	
47		10x40	0.24	376	EHL2VM470G40OT	
		12.5x25	0.24	425	EHL2VM470W25OT	
56		10x45	0.24	426	EHL2VM560G45OT	
		12.5x30	0.24	498	EHL2VM560W30OT	
		16x20	0.24	476	EHL2VM560L20OT	
68		10x50	0.24	486	EHL2VM680G50OT	
		12.5x35	0.24	583	EHL2VM680W35OT	
82		18x20	0.24	550	EHL2VM680M20OT	
		12.5x40	0.24	658	EHL2VM820W40OT	
		16x25	0.24	628	EHL2VM820L25OT	
100		12.5x45	0.24	752	EHL2VM101W45OT	
		12.5x50	0.24	772	EHL2VM101W50OT	
		16x30	0.24	744	EHL2VM101L30OT	
120		18x25	0.24	710	EHL2VM101M25OT	
		16x35	0.24	832	EHL2VM121L35OT	
		16x40	0.24	964	EHL2VM151L40OT	
150		16x45	0.24	978	EHL2VM151L45OT	
		18x30	0.24	944	EHL2VM151M30OT	
180		16x50	0.24	1095	EHL2VM181L50OT	
		18x35	0.24	1065	EHL2VM181M35OT	
		18x40	0.24	1086	EHL2VM181M40OT	
220		18x45	0.24	1215	EHL2VM221M45OT	
		18x50	0.24	1222	EHL2VM221M50OT	

Radial Type

HL series

■ STANDARD RATINGS

WV (Vdc)	Cap (μF)	Size DxL(mm)	tan	Rated ripple current (mA rms/105°C, 120Hz)	Part Number
400(2G)	12	10x16	0.24	135	EHL2GM120G16OT
	15	10x20	0.24	155	EHL2GM150G20OT
	18	10x20	0.24	180	EHL2GM180G20OT
	22	10x25	0.24	216	EHL2GM220G25OT
	27	10x30	0.24	256	EHL2GM270G30OT
		12.5x20	0.24	300	EHL2GM270W20OT
	33	10x35	0.24	300	EHL2GM330G35OT
	39	10x40	0.24	342	EHL2GM390G40OT
		10x45	0.24	358	EHL2GM390G45OT
		12.5x25	0.24	390	EHL2GM390W25OT
	47	12.5x30	0.24	456	EHL2GM470W30OT
		16x20	0.24	438	EHL2GM470L20OT
	56	10x50	0.24	440	EHL2GM560G50OT
		12.5x35	0.24	528	EHL2GM560W35OT
		18x20	0.24	502	EHL2GM560M20OT
	68	12.5x40	0.24	600	EHL2GM680W40OT
		16x25	0.24	572	EHL2GM680L25OT
	82	12.5x45	0.24	684	EHL2GM820W45OT
		12.5x50	0.24	700	EHL2GM820W50OT
		16x30	0.24	672	EHL2GM820L30OT
		18x25	0.24	644	EHL2GM820M25OT
	100	16x35	0.24	760	EHL2GM101L35OT
	120	16x40	0.24	864	EHL2GM101L40OT
		16x45	0.24	880	EHL2GM121L45OT
		18x30	0.24	842	EHL2GM121M30OT
		18x35	0.24	875	EHL2GM121M35OT
	150	16x50	0.24	1000	EHL2GM151L50OT
		18x40	0.24	985	EHL2GM151M40OT
	180	18x45	0.24	1098	EHL2GM181M45OT
	220	18x50	0.24	1225	EHL2GM221M50OT

WV (Vdc)	Cap (μF)	Size DxL(mm)	tan	Rated ripple current (mA rms/105°C, 120Hz)	Part Number	
450(2W)	10	10x16	0.24	120	EHL2WM100G16OT	
	12	10x20	0.24	150	EHL2WM120G20OT	
	15	10x25	0.24	186	EHL2WM150G25OT	
	18	10x30	0.24	216	EHL2WM180G30OT	
		12.5x20	0.24	256	EHL2WM180W20OT	
	22	10x35	0.24	252	EHL2WM220G35OT	
	27	10x40	0.24	292	EHL2WM270G40OT	
		10x45	0.24	306	EHL2WM270G45OT	
		12.5x25	0.24	342	EHL2WM270W25OT	
	33	12.5x30	0.24	400	EHL2WM330W30OT	
		16x20	0.24	386	EHL2WM330L20OT	
	39	10x50	0.24	378	EHL2WM390G50OT	
		12.5x35	0.24	462	EHL2WM390W35OT	
		18x20	0.24	440	EHL2WM390M20OT	
	47	12.5x40	0.24	528	EHL2WM470W40OT	
		16x25	0.24	500	EHL2WM470L25OT	
	56	12.5x45	0.24	592	EHL2WM560W45OT	
		16x30	0.24	588	EHL2WM560L30OT	
		18x25	0.24	562	EHL2WM560M25OT	
	68	12.5x50	0.24	672	EHL2WM680W50OT	
		16x35	0.24	664	EHL2WM680L35OT	
	82	16x40	0.24	750	EHL2WM820L40OT	
		16x45	0.24	762	EHL2WM820L45OT	
		18x30	0.24	734	EHL2WM820M30OT	
	100	16x50	0.24	858	EHL2WM101L50OT	
		18x35	0.24	836	EHL2WM101M35OT	
	120	18x40	0.24	935	EHL2WM121M40OT	
		18x45	0.24	948	EHL2WM121M45OT	
	150	18x50	0.24	1065	EHL2WM151M50OT	
	500(2H)	6.8	10x20	0.24	90	EHL2HM6R8G20OT
		10	10x30	0.24	130	EHL2HM100G30OT
			12.5x20	0.24	125	EHL2HM100W20OT
12		12.5x20	0.24	135	EHL2HM120W20OT	
15		10x35	0.24	170	EHL2HM150G35OT	
		12.5x25	0.24	170	EHL2HM150W25OT	
		16x20	0.24	165	EHL2HM150L20OT	
18		10x45	0.24	190	EHL2HM180G45OT	
		12.5x30	0.24	190	EHL2HM180W30OT	
22		10x50	0.24	230	EHL2HM220G50OT	
		12.5x35	0.24	225	EHL2HM220W35OT	
		16x20	0.24	220	EHL2HM220L20OT	
33		18x25	0.24	285	EHL2HM330M25OT	
47		18x30	0.24	400	EHL2HM470M30OT	

RK series

- Endurance: +105°C 2,000 hours
- Especially designed for charger
- Miniaturized, high voltage
- RoHS Compliant

Upgrade



SPECIFICATIONS

Items	Characteristics				
Category Temperature Range	-40~+105°C(400 V _{dc})		-25~+105°C(450~550 V _{dc})		
Rated Voltage Range	400~550 V _{dc}				
Capacitance Tolerance	±20%(M) (at 20°C, 120Hz)				
Leakage Current	400~450 V _{dc}	500~550 V _{dc}		Where, I: Max. leakage current (μA), C: Nominal capacitance (μF), V: Rated voltage (V) (at 20°C after 2 minutes)	
	I 0.02CV+10μA	I 0.03CV+10μA			
Dissipation Factor (tan δ)	Rated Voltage(V _{dc})	400	450	500	550
	tan δ (max.)	0.15	0.20	0.24	0.24
Low Temperature Characteristics (Max. Impedance Ratio)	Rated Voltage(V _{dc})	400	450	500	550
	Z(-25°C)/Z(+20°C)	3	5	6	15
	Z(-40°C)/Z(+20°C)	6	-	-	-
Endurance	The following specifications shall be satisfied when the capacitors are restored to 20°C after DC voltage plus the rated ripple current is applied for 2,000 hours at 105°C.				
	Rated voltage(V _{dc})	400~500 V _{dc}		550 V _{dc}	
	Capacitance Change	±20% of the initial value		±30% of the initial value	
	D.F. (tan δ)	200% of the initial specified value		300% of the initial specified value	
	Leakage Current	The initial specified value		The initial specified value	
Shelf Life	The following specifications shall be satisfied when the capacitors are restored to 20°C after exposing them for 1,000 hours at 105°C without voltage applied.				
	Capacitance Change	±20% of the initial value			
	D.F. (tan δ)	200% of the initial specified value			
	Leakage Current	200% of the initial specified value			

DIMENSIONS[mm]

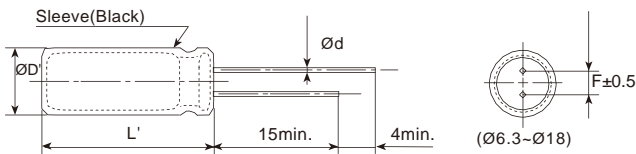

ØD	6.3	8	10	12.5	16	18
Ød	0.5	0.5	0.6	0.6	0.8	0.8
F	2.5	3.5	5.0	5.0	7.5	7.5
ØD'	ØD+0.5max.					
L'	L+2max.					

PART NUMBERING SYSTEM

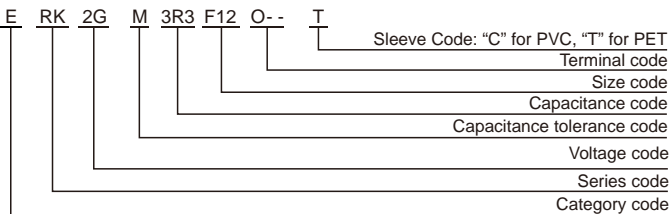

RATED RIPPLE CURRENT MULTIPLIERS

Frequency correction factor for ripple current

WV(V _{dc}) \ Freq.(Hz)	120	1k	10k	100k
	400~550	0.50	0.80	0.90

The endurance of capacitors is shortened with internal heating produced by ripple current at the rate of halving the lifetime with every 5°C rise. When long life performance is required in actual use, the rms ripple current has to be reduced.

RK series

■ STANDARD RATINGS

WV (Vdc)	Cap (μF)	Size DxL(mm)	tan	Rated ripple current (mA _{rms} /105°C, 100kHz)	Part Number
400(2G)	2.2	6.3x9	0.15	64	ERK2GM2R2E09OT
		8x7	0.15	66	ERK2GM2R2F07OT
	3.3	6.3x11	0.15	74	ERK2GM3R3E11OT
		8x9	0.15	76	ERK2GM3R3F09OT
		8x11	0.15	80	ERK2GM3R3F11OT
	4.7	6.3x11	0.15	90	ERK2GM4R7E11OT
		8x9	0.15	94	ERK2GM4R7F09OT
		8x11	0.15	98	ERK2GM4R7F11OT
	6.8	8x11	0.15	126	ERK2GM6R8F11OT
		10x9	0.15	132	ERK2GM6R8G09OT
	8.2	8x11	0.15	145	ERK2GM8R2F11OT
		10x9	0.15	150	ERK2GM8R2G09OT
		10x10	0.15	158	ERK2GM8R2G10OT
	10	8x12	0.15	165	ERK2GM100F12OT
		8x14	0.15	180	ERK2GM100F14OT
		10x9	0.15	172	ERK2GM100G09OT
	15	10x12	0.15	210	ERK2GM150G12OT
		10x14	0.15	230	ERK2GM150G14OT
	22	10x16	0.15	250	ERK2GM220G16OT
		12.5x16	0.15	300	ERK2GM220W16OT
	33	12.5x16	0.15	520	ERK2GM330W16OT
		12.5x22	0.15	650	ERK2GM470W22OT
	47	16x16	0.15	670	ERK2GM470L16OT
		13x25	0.15	780	ERK2GM560K25OT
	68	16x23	0.15	880	ERK2GM680L23OT
		18x18	0.15	880	ERK2GM680M18OT
		18x20	0.15	920	ERK2GM680M20OT
	450(2W)	2.2	6.3x11	0.20	65
8x9			0.20	72	ERK2WM2R2F09OT
3.3		8x9	0.20	82	ERK2WM3R3F09OT
		8x11	0.20	100	ERK2WM4R7F11OT
4.7		10x9	0.20	110	ERK2WM4R7G09OT
		10x9	0.20	130	ERK2WM6R8G09OT
6.8		10x10	0.20	148	ERK2WM6R8G10OT
		10x10	0.20	190	ERK2WM8R2G10OT
8.2		10x10	0.20	190	ERK2WM8R2G10OT
		10x12	0.20	210	ERK2WM8R2G12OT

WV (Vdc)	Cap (μF)	Size DxL(mm)	tan	Rated ripple current (mA _{rms} /105°C, 100kHz)	Part Number	
450(2W)	10	8x16	0.20	220	ERK2WM100F16OT	
		10x12	0.20	230	ERK2WM100G12OT	
		10x14	0.20	250	ERK2WM100G14OT	
	15	10x16	0.20	230	ERK2WM150G16OT	
		12.5x16	0.20	250	ERK2WM150W16OT	
	22	12.5x20	0.20	295	ERK2WM220W20OT	
		16x16	0.20	320	ERK2WM220L16OT	
	33	12.5x22	0.20	495	ERK2WM330W22OT	
		16x16	0.20	495	ERK2WM330L16OT	
		16x20	0.20	550	ERK2WM330L20OT	
	47	16x20	0.20	640	ERK2WM470L20OT	
		16x25	0.20	710	ERK2WM470L25OT	
	68	18x20	0.20	870	ERK2WM680M20OT	
		18x25	0.20	970	ERK2WM680M25OT	
	500(2H)	3.3	8x12	0.24	85	ERK2HM3R3F12OT
			8x12	0.24	110	ERK2HM4R7F12OT
4.7		10x9	0.24	110	ERK2HM4R7G09OT	
		10x9	0.24	130	ERK2HM5R6G09OT	
6.8		10x10	0.24	150	ERK2HM6R8G10OT	
		8.2	10x12	0.24	190	ERK2HM8R2G12OT
10		10x16	0.24	225	ERK2HM100G16OT	
		12	10x16	0.24	230	ERK2HM120G16OT
15		10x18	0.24	250	ERK2HM150G18OT	
		22	12.5x20	0.24	280	ERK2HM220W20OT
550(2J)	3.3	8x12	0.24	85	ERK2JM3R3F12OT	
		10x10	0.24	110	ERK2JM4R7G10OT	
	4.7	10x12	0.24	120	ERK2JM4R7G12OT	
		10x12	0.24	130	ERK2JM5R6G12OT	
	6.8	10x12	0.24	150	ERK2JM6R8G12OT	
		8.2	10x14	0.24	190	ERK2JM8R2G14OT
	10	10x16	0.24	225	ERK2JM100G16OT	
		12	10x20	0.24	235	ERK2JM120G20OT
15	12.5x20	0.24	250	ERK2JM150W20OT		
	22	12.5x25	0.24	280	ERK2JM220W25OT	

RG series

- “GBL” system, high reliability
- Low impedance and high ripple current
- Endurance +105°C 2,000 ~ 8,000 hours
- RoHS Compliant



SPECIFICATIONS

Items	Characteristics								
Category Temperature Range	-55~+105°C								
Rated Voltage Range	6.3~63 V _{dc}								
Capacitance Tolerance	±20%(M) (at 20°C, 120Hz)								
Leakage Current	I 0.01CV or 3μA, whichever is greater. Where, I:Max.leakage current (μA), C:Nominal capacitance (μF), V: Rated voltage (V) (at 20°C after 2 minutes)								
Dissipation Factor (tan δ)	Rated Voltage(V _{dc})	6.3	10	16	25	35	50	63	
	tan δ (max.)	0.22	0.19	0.16	0.14	0.12	0.10	0.08	
	When nominal capacitance exceeds 1,000μF, add 0.02 to the value above for each 1,000μF increase. (at 20°C, 120Hz)								
Low Temperature Characteristics (Max. Impedance Ratio)	Rated Voltage(V _{dc})	6.3	10	16	25	35	50	63	
	Z(-25°C)/Z(+20°C)	4	3			2			
	Z(-55°C)/Z(+20°C)	8	6	4		3			
Endurance	The following specifications shall be met when the capacitors are restored to 20°C after DC voltage plus rated ripple current is applied for a specified period of time at 105°C, the peak voltage shall not exceed the rated voltage.								
	Capacitance Change	±25% of the initial value						Dia.	Load life (hours)
	D.F. (tan δ)	200% of the initial specified value						ØD=6.3	2,000
	Leakage Current	The initial specified value						ØD=8	3,000
								ØD=10	5,000
Shelf Life	The following specifications shall be satisfied when the capacitors are restored to 20 °C after leaving them under no load at 105°C for 1,000 hours.								
	Capacitance Change	±25% of the initial value						ØD=12.5	7,000
	D.F. (tan δ)	200% of the initial specified value						ØD=16	8,000
	Leakage Current	200% of the initial specified value							

DIMENSIONS[mm]

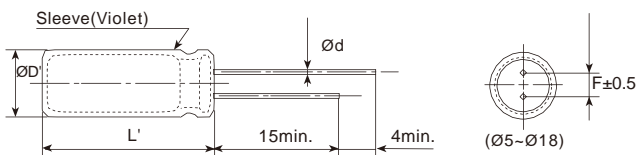

ØD	5	6.3	8	10	12.5	16	18
Ød	0.5	0.5	0.5	0.6	0.6	0.8	0.8
F	2.0	2.5	3.5	5.0	5.0	7.5	7.5
ØD'	ØD+0.5max.						
L'	L+2max.						

PART NUMBERING SYSTEM

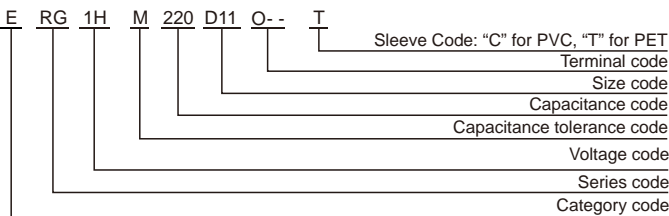

RATED RIPPLE CURRENT MULTIPLIERS

Frequency correction factor for ripple current

Freq.(Hz)	120	1k	10k	100k
Cap.<220	0.40	0.75	0.90	1.00
220 Cap.<680	0.50	0.85	0.94	1.00
680 Cap.<2200	0.60	0.87	0.95	1.00
2200 Cap.<4700	0.75	0.90	0.95	1.00
Cap. 4700	0.85	0.95	0.98	1.00

The endurance of capacitors is shortened with internal heating produced by ripple current at the rate of halving the lifetime with every 5°C rise. When long life performance is required in actual use, the rms ripple current has to be reduced.

RV series

- High stability, high conductivity, high reliability
- Low impedance, small size
- Endurance +105°C 4,000~5,000 hours
- RoHS Compliant



SPECIFICATIONS

Items	Characteristics					
Category Temperature Range	-55~+105°C					
Rated Voltage Range	6.3~35 V _{dc}					
Capacitance Tolerance	±20%(M) (at 20°C, 120Hz)					
Leakage Current	I ≤ 0.01CV or 3μA, whichever is greater. Where, I:Max.leakage current (μA),C:Nominal capacitance (μF),V: Rated voltage (V) (at 20°C after 2 minutes)					
Dissipation Factor (tan δ)	Rated Voltage(V _{dc})	6.3	10	16	25	35
	tan δ (max.)	0.22	0.19	0.16	0.14	0.12
	When nominal capacitance exceeds 1,000μF, add 0.02 to the value above for each 1,000μF increase. (at 20°C, 120Hz)					
Low Temperature Characteristics (Max. Impedance Ratio)	Rated Voltage(V _{dc})	6.3	10	16	25	35
	Z(-55°C)/Z(+20°C)	8	6	4	3	
Endurance	The following specifications shall be satisfied when the capacitors are restored to 20°C after DC voltage plus the rated ripple current is applied for a specified period of time (Ø10: 4,000h; Ø12.5: 5,000h) at 105°C.					
	Capacitance Change	±20% of the initial value (6.3V, 10V: ±30%)				
	D.F. (tan δ)	200% of the initial specified value				
	Leakage Current	The initial specified value				
Shelf Life	The following specifications shall be satisfied when the capacitors are restored to 20°C after exposing them for 1,000 hours at 105°C without voltage applied.					
	Capacitance Change	±20% of the initial value(6.3V, 10V: ±30%)				
	D.F. (tan δ)	200% of the initial specified value				
	Leakage Current	200% of the initial specified value				

DIMENSIONS[mm]

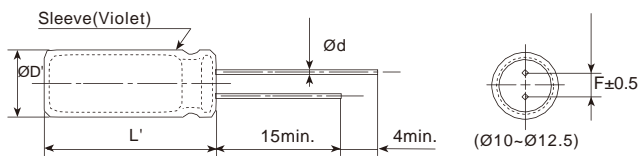

ØD	10	12.5
Ød	0.6	0.6
F	5.0	5.0
ØD'	ØD+0.5max.	
L'	L+2max.	

PART NUMBERING SYSTEM

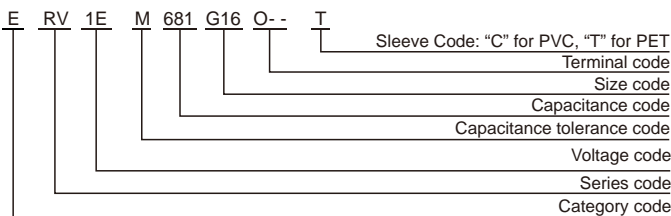

RATED RIPPLE CURRENT MULTIPLIERS

Frequency correction factor for ripple current

Freq.(Hz)	120	1k	10k	100k
Cap.<680	0.50	0.85	0.94	1.00
680 Cap.<2200	0.60	0.87	0.95	1.00
2200 Cap.<4700	0.75	0.90	0.95	1.00
Cap. 4700	0.85	0.95	0.98	1.00

The endurance of capacitors is shortened with internal heating produced by ripple current at the rate of halving the lifetime with every 5°C rise. When long life performance is required in actual use, the rms ripple current has to be reduced.

RV series

■ STANDARD RATINGS

WV (V _{dc})	Cap (μF)	Size DxL(mm)	tan	Impedance (max/20°C,100kHz)	Rated ripple current (mArms/105°C,100kHz)	Part Number
6.3(0J)	1500	10x12.5	0.22	0.063	960	ERV0JM152G1BOT
	1800	10x16	0.22	0.049	1240	ERV0JM182G16OT
	2700	10x20	0.24	0.035	1550	ERV0JM272G20OT
	3300	10x25	0.26	0.033	1740	ERV0JM332G25OT
	4700	12.5x20	0.28	0.029	1890	ERV0JM472W20OT
	6800	12.5x25	0.32	0.022	2350	ERV0JM682W25OT
10(1A)	1000	10x12.5	0.19	0.063	960	ERV1AM102G1BOT
	1500	10x16	0.19	0.049	1240	ERV1AM152G16OT
	2200	10x20	0.21	0.035	1550	ERV1AM222G20OT
	2700	10x25	0.21	0.033	1740	ERV1AM272G25OT
	3300	12.5x20	0.23	0.029	1890	ERV1AM332W20OT
	4700	12.5x25	0.25	0.022	2350	ERV1AM472W25OT
16(1C)	820	10x12.5	0.16	0.063	960	ERV1CM821G1BOT
	1000	10x16	0.16	0.049	1240	ERV1CM102G16OT
	1500	10x20	0.16	0.035	1550	ERV1CM152G20OT
	1800	10x25	0.16	0.033	1740	ERV1CM182G25OT
	2200	12.5x20	0.18	0.029	1890	ERV1CM222W20OT
	3300	12.5x25	0.20	0.022	2350	ERV1CM332W25OT
25(1E)	470	10x12.5	0.14	0.063	960	ERV1EM471G1BOT
	680	10x16	0.14	0.049	1240	ERV1EM681G16OT
	1000	10x20	0.14	0.035	1550	ERV1EM102G20OT
	1200	10x25	0.14	0.033	1740	ERV1EM122G25OT
	1500	12.5x20	0.14	0.029	1890	ERV1EM152W20OT
	2200	12.5x25	0.16	0.022	2350	ERV1EM222W25OT
35(1V)	330	10x12.5	0.12	0.063	960	ERV1VM331G1BOT
	470	10x16	0.12	0.049	1240	ERV1VM471G16OT
	680	10x20	0.12	0.035	1550	ERV1VM681G20OT
	820	10x25	0.12	0.033	1740	ERV1VM821G25OT
	1000	12.5x20	0.12	0.029	1890	ERV1VM102W20OT
	1500	12.5x25	0.12	0.022	2350	ERV1VM152W25OT

ML series

- Long life with 5mm to 9mm height.
- Endurance +105°C 3,000~5,000 hours
- RoHS Compliant



SPECIFICATIONS

Items	Characteristics
Category Temperature Range	-40~+105°C
Rated Voltage Range	6.3~50 V _{dc}
Capacitance Tolerance	±20%(M) (at 20°C,120Hz)
Leakage Current	I 0.01CV or 3μA, whichever is greater. Where, I:Max.leakage current (μA),C:Nominal capacitance (μF),V: Rated voltage (V) (at 20°C after 2 minutes)
Dissipation Factor (tan δ)	Rated Voltage(V _{dc}) 6.3 10 16 25 35 50
	tan (max.) 0.40 0.35 0.30 0.25 0.20 0.20
	When nominal capacitance exceeds 1,000μF, add 0.02 to the value above for each 1,000μF increase. (at 20°C,120Hz)
Low Temperature Characteristics (Max. Impedance Ratio)	Rated Voltage(V _{dc}) 6.3 10 16 25 35 50
	Z(-25°C)/Z(+20°C) 6 4 4 3 2 2
	Z(-40°C)/Z(+20°C) 12 10 8 6 4 4 (at 120Hz)
Endurance	The following specifications shall be satisfied when the capacitors are restored to 20°C after DC voltage plus the rated ripple current is applied for a specified period of time at 105°C.
	Capacitance Change ±30% of the initial value
	D.F. (tan δ) 300% of the initial specified value
	Leakage Current The initial specified value
Shelf Life	The following specifications shall be satisfied when the capacitors are restored to 20°C after exposing them for 1,000 hours at 105°C without voltage applied.
	Capacitance Change ±30% of the initial value
	D.F. (tan δ) 300% of the initial specified value
	Leakage Current 200% of the initial specified value

DIMENSIONS[mm]

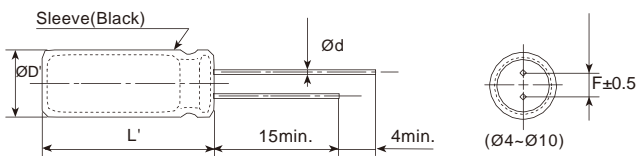

ØD	4		5		6.3		8			10×9
	6.3×5	6.3×7	8×5	8×7	8×9					
Ød	0.45	0.45	0.45	0.5	0.45	0.5	0.5	0.5	0.6	
F	1.5	2.0	2.5	2.5	3.5	3.5	3.5	5.0		
ØD'	ØD+0.5max.									
L'	L+2max.									

PART NUMBERING SYSTEM

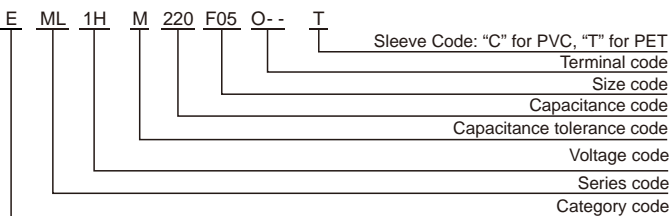

RATED RIPPLE CURRENT MULTIPLIERS

Frequency correction factor for ripple current

Freq.(Hz)	60(50)	120	500	1k	10k
Cap.<2.2	0.50	1.00	1.20	1.30	1.50
2.2 Cap.<10	0.65	1.00	1.20	1.30	1.50
10 Cap.<100	0.80	1.00	1.20	1.30	1.50
Cap. 100	0.80	1.00	1.10	1.15	1.20

The endurance of capacitors is shortened with internal heating produced by ripple current at the rate of halving the lifetime with every 5°C rise. When long life performance is required in actual use, the rms ripple current has to be reduced.

ML series

■ STANDARD RATINGS

WV (Vdc)	Cap (μF)	Size DxL(mm)	tan	Rated ripple current (mA _{rms} /105°C, 120Hz)	Part Number
6.3(0J)	27	4x5	0.40	25	EML0JM270C05OT
	47	4x7	0.40	47	EML0JM470C07OT
	56	5x5	0.40	50	EML0JM560D05OT
	82	5x7	0.40	75	EML0JM820D07OT
	120	6.3x5	0.40	80	EML0JM121E05OT
	180	6.3x7	0.40	110	EML0JM181E07OT
	220	8x5	0.40	125	EML0JM221F05OT
	270	8x7	0.40	165	EML0JM271F07OT
	470	8x7	0.40	190	EML0JM471F07OT
	560	8x9	0.40	230	EML0JM561F09OT
1000	10x9	0.40	480	EML0JM102G09OT	
10(1A)	22	4x5	0.35	22	EML1AM220C05OT
	33	4x7	0.35	43	EML1AM330C07OT
	47	5x5	0.35	48	EML1AM470D05OT
	56	5x7	0.35	68	EML1AM560D07OT
	100	6.3x5	0.35	75	EML1AM101E05OT
	120	6.3x7	0.35	100	EML1AM121E07OT
	180	8x5	0.35	120	EML1AM181F05OT
	220	8x7	0.35	160	EML1AM221F07OT
	330	8x7	0.35	180	EML1AM331F07OT
	470	8x9	0.35	210	EML1AM471F09OT
680	10x9	0.35	470	EML1AM681G09OT	
16(1C)	18	4x5	0.30	20	EML1CM180C05OT
	22	4x7	0.30	40	EML1CM220C07OT
	33	5x5	0.30	45	EML1CM330D05OT
	39	5x7	0.30	65	EML1CM390D07OT
	68	6.3x5	0.30	70	EML1CM680E05OT
	100	6.3x7	0.30	95	EML1CM101E07OT
	120	8x5	0.30	110	EML1CM121F05OT
	150	8x7	0.30	125	EML1CM151F07OT
	220	8x7	0.30	170	EML1CM221F07OT
	330	8x9	0.30	195	EML1CM331F09OT
470	10x9	0.30	460	EML1CM471G09OT	
25(1E)	10	4x5	0.25	18	EML1EM100C05OT
	15	4x7	0.25	35	EML1EM150C07OT
	22	5x5	0.25	42	EML1EM220D05OT
	27	5x7	0.25	57	EML1EM270D07OT
	47	6.3x5	0.25	65	EML1EM470E05OT
	56	6.3x7	0.25	85	EML1EM560E07OT
	82	8x5	0.25	100	EML1EM820F05OT
	100	8x7	0.25	112	EML1EM101F07OT
	150	8x7	0.25	140	EML1EM151F07OT
	220	8x9	0.25	190	EML1EM221F09OT
330	10x9	0.25	450	EML1EM331G09OT	

WV (Vdc)	Cap (μF)	Size DxL(mm)	tan	Rated ripple current (mA _{rms} /105°C, 120Hz)	Part Number
35(1V)	6.8	4x5	0.20	17	EML1VM6R8C05OT
	10	4x7	0.20	28	EML1VM100C07OT
	12	5x5	0.20	34	EML1VM120D05OT
	18	5x7	0.20	48	EML1VM180D07OT
	27	6.3x5	0.20	58	EML1VM270E05OT
	39	6.3x7	0.20	76	EML1VM390E07OT
	47	8x5	0.20	80	EML1VM470F05OT
	56	8x7	0.20	105	EML1VM560F07OT
	100	8x7	0.20	125	EML1VM101F07OT
	150	8x9	0.20	180	EML1VM151F09OT
	220	10x9	0.20	360	EML1VM221G09OT
	50(1H)	1	4x5	0.20	8
2.2		4x5	0.20	11	EML1HM2R2C05OT
3.3		4x5	0.20	14	EML1HM3R3C05OT
4.7		4x7	0.20	23	EML1HM4R7C07OT
6.8		5x5	0.20	25	EML1HM6R8D05OT
10		5x7	0.20	30	EML1HM100D07OT
12		6.3x5	0.20	37	EML1HM120E05OT
18		6.3x7	0.20	50	EML1HM180E07OT
22		8x5	0.20	62	EML1HM220F05OT
33		8x7	0.20	75	EML1HM330F07OT
56		8x7	0.20	115	EML1HM560F07OT
82		8x9	0.20	160	EML1HM820F09OT
120		10x9	0.20	315	EML1HM121G09OT

RM series

- Endurance +105°C 10,000 hours
- Miniaturized, long life
- RoHS Compliant



SPECIFICATIONS

Items	Characteristics								
Category Temperature Range	-40~+105°C								
Rated Voltage Range	10~100 V _{dc}								
Capacitance Tolerance	±20%(M) (at 20°C, 120Hz)								
Leakage Current	I ≤ 0.01CV or 3μA, whichever is greater. Where, I: Max. leakage current (μA), C: Nominal capacitance (μF), V: Rated voltage (V) (at 20°C after 2 minutes)								
Dissipation Factor (tan δ)	Rated Voltage(V _{dc})	10	16	25	35	50	63	100	
	tan δ (max.)	0.45	0.35	0.30	0.22	0.19	0.17	0.15	
When nominal capacitance exceeds 1,000μF, add 0.02 to the value above for each 1,000μF increase. (at 20°C, 120Hz)									
Low Temperature Characteristics (Max. Impedance Ratio)	Rated Voltage(V _{dc})	10	16	25	35	50	63	100	
	Z(-25°C)/Z(+20°C)	8	6	4	3				
	Z(-40°C)/Z(+20°C)	13	10	8	7				
(at 120Hz)									
Endurance	The specifications listed below shall be met when the capacitors are restored to 20°C after DC voltage plus rated ripple current is applied for 10,000 hours at 105°C.								
	Capacitance Change	±25% of the initial value							
	D.F. (tan δ)	300% of the initial specified value							
	Leakage Current	The initial specified value							
Shelf Life	The following specifications shall be satisfied when the capacitors are restored to 20°C after leaving them under no load at 105°C for 1,000 hours.								
	Capacitance Change	±20% of the initial value							
	D.F. (tan δ)	200% of the initial specified value							
	Leakage Current	200% of the initial specified value							

DIMENSIONS[mm]

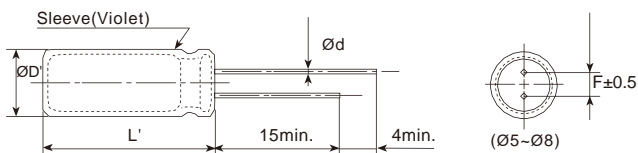

ØD	5	6.3	8
Ød	0.5	0.5	0.5
F	2.0	2.5	3.5
ØD'	ØD+0.5max.		
L'	L+1.5max.		

PART NUMBERING SYSTEM

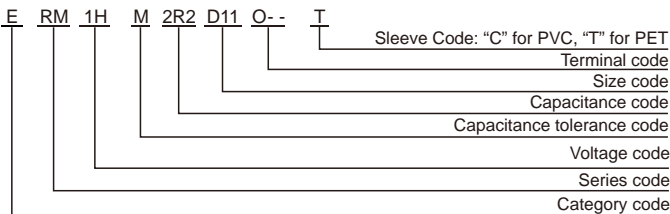

RATED RIPPLE CURRENT MULTIPLIERS

Frequency correction factor for ripple current

Freq.(Hz) \ Cap.(μF)	120	1k	10k	100k
Cap. <22	0.42	0.60	0.80	1.00
22 Cap. <47	0.55	0.75	0.90	1.00
Cap. 47	0.70	0.85	0.95	1.00

The endurance of capacitors is shortened with internal heating produced by ripple current at the rate of halving the lifetime with every 5°C rise. When long life performance is required in actual use, the rms ripple current has to be reduced.

RM series

■ STANDARD RATINGS

WV (V _{dc})	Cap (μF)	Size DxL(mm)	tan	Rated ripple current (mA _{rms} /105°C,100kHz)	Part Number
10(1A)	100	5x11	0.45	130	ERM1AM101D11OT
	220	6.3x11	0.45	210	ERM1AM221E11OT
	330	8x11	0.45	330	ERM1AM331F11OT
16(1C)	47	5x11	0.35	130	ERM1CM470D11OT
	100	6.3x11	0.35	210	ERM1CM101E11OT
	220	8x11	0.35	330	ERM1CM221F11OT
25(1E)	33	5x11	0.30	130	ERM1EM330D11OT
	47	5x11	0.30	130	ERM1EM470D11OT
	100	6.3x11	0.30	210	ERM1EM101E11OT
35(1V)	33	5x11	0.22	130	ERM1VM330D11OT
	47	6.3x11	0.22	210	ERM1VM470E11OT
	100	8x11	0.22	330	ERM1VM101F11OT
50(1H)	0.47	5x11	0.19	12	ERM1HMR47D11OT
	1	5x11	0.19	25	ERM1HM010D11OT
	2.2	5x11	0.19	35	ERM1HM2R2D11OT
	3.3	5x11	0.19	70	ERM1HM3R3D11OT
	4.7	5x11	0.19	80	ERM1HM4R7D11OT
	10	5x11	0.19	90	ERM1HM100D11OT
	22	5x12	0.19	110	ERM1HM220D12OT
	33	6.3x11	0.19	190	ERM1HM330E11OT
	47	6.3x11	0.19	190	ERM1HM470E11OT
100	8x12	0.19	270	ERM1HM101F12OT	
63(1J)	10	5x11	0.17	80	ERM1JM100D11OT
	22	6.3x11	0.17	170	ERM1JM220E11OT
	33	6.3x12	0.17	170	ERM1JM330E12OT
	47	8x12	0.17	240	ERM1JM470F12OT
100(1K)	0.47	5x11	0.15	20	ERM1KMR47D11OT
	1	5x11	0.15	40	ERM1KM010D11OT
	2.2	5x11	0.15	50	ERM1KM2R2D11OT
	3.3	5x11	0.15	60	ERM1KM3R3D11OT
	4.7	5x11	0.15	70	ERM1KM4R7D11OT
	10	6.3x12	0.15	150	ERM1KM100E12OT
	22	8x12	0.15	230	ERM1KM220F12OT

NB series

- High reliability, withstand high temperature
- Endurance +130°C 2,000~5,000 hours
- RoHS Compliant

Upgrade



SPECIFICATIONS

Items	Characteristics										
Category Temperature Range	-40~+130°C										
Rated Voltage Range	10~120 V _{dc}										
Capacitance Tolerance	±20%(M) (at 20°C, 120Hz)										
Leakage Current	I ≤ 0.01CV or 3μA, whichever is greater. Where, I: Max. leakage current (μA), C: Nominal capacitance (μF), V: Rated voltage (V) (at 20°C after 2 minutes)										
Dissipation Factor (tan δ)	Rated Voltage(V _{dc})	10	16	25	35	50	63	80	100	120	(at 20°C, 120Hz)
	tan δ (max.)	0.24	0.20	0.18	0.16	0.14	0.12	0.12	0.10	0.12	
Low Temperature Characteristics (Max. Impedance Ratio)	Rated Voltage(V _{dc})	10	16	25	35	50	63	80	100	120	(at 120Hz)
	Z(-25°C)/Z(+20°C)	3		2				3			
	Z(-40°C)/Z(+20°C)	6		3				6			
Endurance	The specifications listed below shall be met when the capacitors are restored to 20°C after DC voltage plus rated ripple current is applied for a specified period of time at 130°C.										
	Capacitance Change	±30% of the initial value								Dia. (mm)	
	D.F. (tan δ)	300% of the initial specified value								Load life (hours)	
	Leakage Current	The initial specified value								ØD=5&6.3	
										ØD=8	
Shelf Life	The following specifications shall be satisfied when the capacitors are restored to 20°C after leaving them under no load at 130°C for 1,000 hours.										
	Capacitance Change	±30% of the initial value								ØD=10	
	D.F. (tan δ)	300% of the initial specified value								ØD=12.5	
	Leakage Current	500% of the initial specified value								ØD=18	

DIMENSIONS[mm]

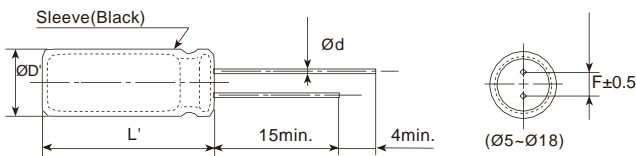

ØD	5	6.3	8	10	12.5	16	18
Ød	0.5	0.5	0.5	0.6	0.6	0.8	0.8
F	2.0	2.5	3.5	5.0	5.0	7.5	7.5
ØD'	ØD+0.5max.						
L'	L+2max.						

PART NUMBERING SYSTEM

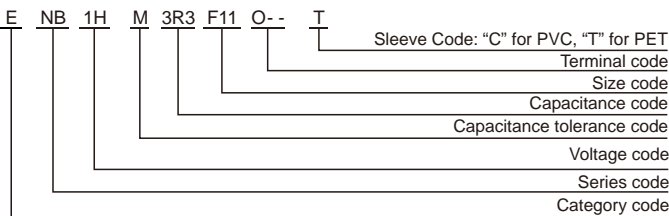

RATED RIPPLE CURRENT MULTIPLIERS

Frequency correction factor for ripple current

Cap.(μF) \ Freq.(Hz)	50/60	120	1k	10k	100k
Cap.<10	0.35	0.42	0.60	0.80	1.00
10 Cap.<47	0.45	0.55	0.75	0.90	1.00
47 Cap.<470	0.60	0.70	0.85	0.95	1.00
470 Cap.<2200	0.65	0.75	0.90	0.98	1.00
Cap. 2200	0.75	0.80	0.95	1.00	1.00

The endurance of capacitors is shortened with internal heating produced by ripple current at the rate of halving the lifetime with every 5°C rise. When long life performance is required in actual use, the rms ripple current has to be reduced.

NB series

■ STANDARD RATINGS

WV (Vdc)	Cap (μF)	Size DxL(mm)	Rated ripple current (mA _{RMS} /130°C, 100kHz)	Part Number
10(1A)	330	6.3x12	180	ENB1AM331E12OT
		8x11	360	ENB1AM331F11OT
	470	8x12	360	ENB1AM471F12OT
		10x13	620	ENB1AM471G13OT
	680	8x12	400	ENB1AM681F12OT
		10x13	620	ENB1AM681G13OT
	1000	10x16	660	ENB1AM102G16OT
		10x20	960	ENB1AM102G20OT
	2200	12.5x25	1430	ENB1AM222W25OT
3300	16x25	1900	ENB1AM332L25OT	
4700	16x30	2300	ENB1AM472L30OT	
16(1C)	100	5x11	90	ENB1CM101D11OT
	220	6.3x11	125	ENB1CM221E11OT
	330	8x12	360	ENB1CM331F12OT
		8x12	360	ENB1CM471G12OT
	470	10x13	620	ENB1CM471G13OT
		10x20	960	ENB1CM102G20OT
	2200	10x25	980	ENB1CM222G25OT
		12.5x25	1430	ENB1CM222W25OT
	3300	16x30	2300	ENB1CM332L30OT
4700	16x35	2550	ENB1CM472L35OT	
25(1E)	220	8x12	360	ENB1EM221F12OT
		8x12	360	ENB1EM331F12OT
		10x13	620	ENB1EM331G13OT
	470	8x16	610	ENB1EM471F16OT
		10x16	800	ENB1EM471G16OT
	1000	10x20	960	ENB1EM102G20OT
		12.5x20	1100	ENB1EM102W20OT
2200	16x30	2300	ENB1EM222L30OT	
3300	16x35	2550	ENB1EM332L35OT	
35(1V)	100	6.3x12	210	ENB1VM101E12OT
		8x11	360	ENB1VM101F11OT
	220	8x12	375	ENB1VM221F12OT
		10x13	620	ENB1VM221G13OT
	330	8x16	550	ENB1VM331F16OT
		10x16	800	ENB1VM331G16OT
	470	10x16	705	ENB1VM471G16OT
		10x20	960	ENB1VM471G20OT
	1000	12.5x20	1180	ENB1VM102W20OT
12.5x25		1430	ENB1VM102W25OT	
2200	16x35	2550	ENB1VM222L35OT	
3300	18x35	2800	ENB1VM332M35OT	
50(1H)	1	5x11	26	ENB1HM010D11OT
		5x11	35	ENB1HM2R2D11OT
	2.2	8x11	50	ENB1HM2R2F11OT
		5x11	40	ENB1HM3R3D11OT
	3.3	8x11	70	ENB1HM3R3F11OT
		5x11	42	ENB1HM4R7D11OT
	4.7	8x11	100	ENB1HM4R7F11OT
		5x11	90	ENB1HM100D11OT
	10	8x11	200	ENB1HM100F11OT
		5x12	110	ENB1HM220D12OT
	22	8x11	260	ENB1HM220F11OT
		6.3x11	150	ENB1HM330E11OT
	33	8x11	300	ENB1HM330F11OT
		6.3x11	180	ENB1HM470E11OT
	47	8x11	300	ENB1HM470F11OT
		8x12	340	ENB1HM101F12OT
	100	10x13	520	ENB1HM101G13OT
		8x16	520	ENB1HM221F16OT
	220	10x20	890	ENB1HM221G20OT
		10x16	530	ENB1HM331G16OT
	330	12.5x20	1000	ENB1HM331W20OT
10x20		950	ENB1HM471G20OT	

WV (Vdc)	Cap (μF)	Size DxL(mm)	Rated ripple current (mA _{RMS} /130°C, 100kHz)	Part Number
50(1H)	470	12.5x25	1200	ENB1HM471W25OT
		12.5x20	1060	ENB1HM681W20OT
	680	16x20	1250	ENB1HM681L20OT
		12.5x25	1500	ENB1HM102W25OT
	1000	16x30	2180	ENB1HM102L30OT
2200	18x40	2800	ENB1HM222M40OT	
63(1J)	33	6.3x12	150	ENB1JM330E12OT
		8x11	250	ENB1JM330F11OT
	47	8x12	250	ENB1JM470F12OT
		10x13	400	ENB1JM470G13OT
	100	8x12	340	ENB1JM101F12OT
		10x16	450	ENB1JM101G16OT
	220	10x16	450	ENB1JM221G16OT
		12.5x20	820	ENB1JM221W20OT
	330	12.5x20	850	ENB1JM331W20OT
12.5x25		1000	ENB1JM331W25OT	
470	13x25	1000	ENB1JM471K25OT	
	16x25	1500	ENB1JM471L25OT	
1000	16x30	1850	ENB1JM102L30OT	
80(1B)	4.7	5x11	26	ENB1BM4R7D11OT
	10	5x11	68	ENB1BM100D11OT
	22	6.3x11	105	ENB1BM220E11OT
	33	6.3x12	135	ENB1BM330E12OT
		8x12	250	ENB1BM330F12OT
	100	8x16	400	ENB1BM101F16OT
	220	10x20	750	ENB1BM221G20OT
	330	12.5x20	850	ENB1BM331W20OT
	470	16x20	1200	ENB1BM471L20OT
100(1K)	4.7	5x11	40	ENB1KM4R7D11OT
		8x11	100	ENB1KM4R7F11OT
	10	6.3x11	130	ENB1KM100E11OT
		8x11	200	ENB1KM100F11OT
	22	6.3x12	150	ENB1KM220E12OT
		8x12	220	ENB1KM220F12OT
	33	8x12	220	ENB1KM330F12OT
		10x13	260	ENB1KM330G13OT
	47	8x16	240	ENB1KM470F16OT
		10x16	330	ENB1KM470G16OT
100	10x16	350	ENB1KM101G16OT	
	12.5x20	670	ENB1KM101W20OT	
220	13x20	720	ENB1KM221K20OT	
	16x25	1100	ENB1KM221L25OT	
330	16x25	1300	ENB1KM331L25OT	
	16x30	1300	ENB1KM331L30OT	
470	18x30	1600	ENB1KM471M30OT	
120(2B)	22	8x12	115	ENB2BM220F12OT
		8x16	200	ENB2BM330F16OT
	33	10x13	200	ENB2BM330G13OT
		8x20	240	ENB2BM470F20OT
	47	10x16	240	ENB2BM470G16OT
		10x16	255	ENB2BM560G16OT
	68	10x16	255	ENB2BM680G16OT
		10x20	270	ENB2BM820G20OT
	100	10x25	340	ENB2BM101G25OT
		12.5x20	465	ENB2BM121W20OT
	150	12.5x25	515	ENB2BM151W25OT
		13x30	630	ENB2BM221K30OT
	220	16x20	630	ENB2BM221L20OT
		16x25	720	ENB2BM271L25OT
	270	18x20	720	ENB2BM271M20OT
		16x30	775	ENB2BM331L30OT
	330	18x25	775	ENB2BM331M25OT
16x40		865	ENB2BM471L40OT	
470	18x30	865	ENB2BM471M30OT	

RD series

- Endurance +105°C 2,000~5,000 hours
- High frequency and low impedance; moisture content: under 40%
- RoHS Compliant



SPECIFICATIONS

Items	Characteristics										
Category Temperature Range	-40~+105°C(6.3~100 V _{dc})										
Rated Voltage Range	6.3~100 V _{dc}										
Capacitance Tolerance	±20%(M) (at 20°C,120Hz)										
Leakage Current	I ≤ 0.01CV or 3μA, whichever is greater. Where, I:Max.leakage current (μA),C:Nominal capacitance (μF),V: Rated voltage (V) (at 20°C after 2 minutes)										
Dissipation Factor (tan δ)	Rated Voltage(V _{dc})	6.3	10	16	25	35	50	63	100		
	tan δ (max.)	0.22	0.19	0.16	0.14	0.12	0.10	0.09	0.08		
	When nominal capacitance exceeds 1,000μF, add 0.02 to the value above for each 1,000μF increase. (at 20°C,120Hz)										
Low Temperature Characteristics (Max. Impedance Ratio)	Rated Voltage(V _{dc})	6.3	10	16	25	35	50	63	100		
	Z(-25°C)/Z(+20°C)	4	3	2	2			2			
	Z(-40°C)/Z(+20°C)	8	6	4	3			3			
Endurance	The following specifications shall be satisfied when the capacitors are restored to 20°C after DC voltage plus the rated ripple current is applied for a specified period of time at 105 °C.										
	Capacitance Change	±25% of the initial value							Dia. (mm)		Load life (hours)
	D.F. (tan δ)	200% of the initial specified value							ØD 6.3		2,000
	Leakage Current	The initial specified value							ØD=8		3,000
									ØD 10		5,000
Shelf Life	The following specifications shall be satisfied when the capacitors are restored to 20°C after exposing them for 1,000 hours at 105°C without voltage applied.										
	Capacitance Change	±25% of the initial value									
	D.F. (tan δ)	200% of the initial specified value									
	Leakage Current	200% of the initial specified value									

DIMENSIONS[mm]

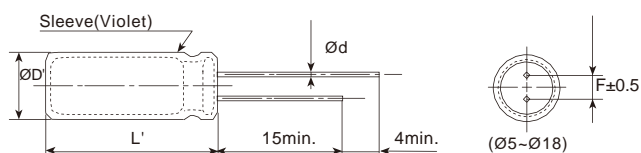

ØD	5	6.3	8	10	12.5	16	18
Ød	0.5	0.5	0.5	0.6	0.6	0.8	0.8
F	2.0	2.5	3.5	5.0	5.0	7.5	7.5
ØD'	ØD+0.5max.						
L'	L+2max.						

PART NUMBERING SYSTEM

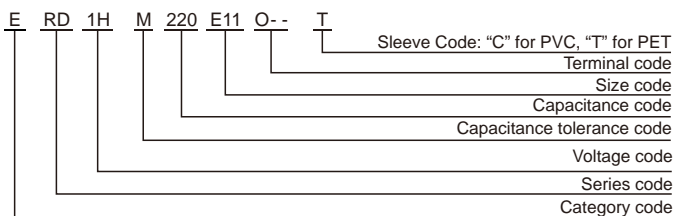

RATED RIPPLE CURRENT MULTIPLIERS

Frequency correction factor for ripple current

Cap.(μF) \ Freq.(Hz)	120	1k	10k	100k
Cap.<220	0.40	0.75	0.90	1.00
220 Cap.<680	0.50	0.85	0.94	1.00
680 Cap.<2200	0.60	0.87	0.95	1.00
2200 Cap.<4700	0.75	0.90	0.95	1.00
Cap. 4700	0.85	0.95	0.98	1.00

The endurance of capacitors is shortened with internal heating produced by ripple current at the rate of halving the lifetime with every 5°C rise. When long life performance is required in actual use, the rms ripple current has to be reduced.

RD series

■ STANDARD RATINGS

WV (V _{dc})	Cap (μF)	Size D×L(mm)	tan	Impedance (max/20°C, 100kHz)	Rated ripple current (mArms/105°C, 100kHz)	Part Number
6.3(0J)	100	5×11	0.22	1.00	170	ERD0JM101D11OT
	120	5×11	0.22	0.92	175	ERD0JM121D11OT
	150	6.3×11	0.22	0.81	220	ERD0JM151E11OT
	180	6.3×11	0.22	0.76	210	ERD0JM181E11OT
	220	6.3×11	0.22	0.65	310	ERD0JM221E11OT
	270	6.3×11	0.22	0.54	320	ERD0JM271E11OT
	330	8×11	0.22	0.42	390	ERD0JM331F11OT
	470	8×11	0.22	0.25	450	ERD0JM471F11OT
	560	8×11	0.22	0.23	490	ERD0JM561F11OT
	680	8×11	0.22	0.21	520	ERD0JM681F11OT
	820	8×16	0.22	0.20	620	ERD0JM821F16OT
	1000	10×12.5	0.22	0.17	750	ERD0JM102G1BOT
	1200	10×16	0.22	0.16	860	ERD0JM122G16OT
	1500	10×16	0.22	0.14	1100	ERD0JM152G16OT
	1800	10×20	0.22	0.11	1250	ERD0JM182G20OT
	2200	10×25	0.24	0.095	1470	ERD0JM222G25OT
	2700	12.5×20	0.24	0.075	1500	ERD0JM272W20OT
	3300	12.5×20	0.26	0.036	1650	ERD0JM332W20OT
	4700	12.5×30	0.28	0.036	2100	ERD0JM472W30OT
	5600	12.5×30	0.30	0.034	2340	ERD0JM562W30OT
6800	16×25	0.32	0.032	2450	ERD0JM682L25OT	
8200	16×30	0.36	0.027	2650	ERD0JM822L30OT	
10000	16×35	0.40	0.024	2700	ERD0JM103L35OT	
15000	18×35	0.50	0.023	2950	ERD0JM153M35OT	
10(1A)	22	5×11	0.19	2.70	98	ERD1AM220D11OT
	33	5×11	0.19	2.60	100	ERD1AM330D11OT
	47	5×11	0.19	1.34	150	ERD1AM470D11OT
	56	5×11	0.19	1.23	160	ERD1AM560D11OT
	68	5×11	0.19	1.05	170	ERD1AM680D11OT
	100	5×11	0.19	0.80	210	ERD1AM101D11OT
	120	6.3×11	0.19	0.75	250	ERD1AM121E11OT
	150	6.3×11	0.19	0.61	290	ERD1AM151E11OT
	180	6.3×11	0.19	0.46	320	ERD1AM181E11OT
	220	6.3×11	0.19	0.35	340	ERD1AM221E11OT
	270	8×11	0.19	0.30	400	ERD1AM271F11OT
	330	8×11	0.19	0.27	460	ERD1AM331F11OT
	470	8×11	0.19	0.25	580	ERD1AM471F11OT
	560	10×12.5	0.19	0.16	635	ERD1AM561G1BOT
	680	10×12.5	0.19	0.11	765	ERD1AM681G1BOT
	820	10×16	0.19	0.10	890	ERD1AM821G16OT
	1000	10×16	0.19	0.076	1040	ERD1AM102G16OT
	1200	10×16	0.19	0.067	1200	ERD1AM122G16OT
	1500	10×20	0.19	0.062	1400	ERD1AM152G20OT
	1800	10×25	0.19	0.058	1550	ERD1AM182G25OT
2200	12.5×20	0.21	0.041	1750	ERD1AM222W20OT	
2700	12.5×20	0.21	0.035	1900	ERD1AM272W20OT	
3300	12.5×25	0.23	0.031	2000	ERD1AM332W25OT	
4700	16×25	0.25	0.030	2100	ERD1AM472L25OT	
5600	16×25	0.27	0.028	2290	ERD1AM562L25OT	
6800	16×30	0.29	0.026	2650	ERD1AM682L30OT	
8200	16×35	0.33	0.026	2770	ERD1AM822L35OT	
10000	18×35	0.37	0.024	2580	ERD1AM103M35OT	
16(1C)	10	5×11	0.16	4.7	74	ERD1CM100D11OT
	22	5×11	0.16	2.6	100	ERD1CM220D11OT
	33	5×11	0.16	2.0	114	ERD1CM330D11OT
	47	5×11	0.16	1.1	155	ERD1CM470D11OT

WV (V _{dc})	Cap (μF)	Size D×L(mm)	tan	Impedance (max/20°C, 100kHz)	Rated ripple current (mArms/105°C, 100kHz)	Part Number
16(1C)	56	5×11	0.16	0.82	180	ERD1CM560D11OT
	68	5×11	0.16	0.69	195	ERD1CM680D11OT
	100	6.3×11	0.16	0.50	265	ERD1CM101E11OT
	120	6.3×11	0.16	0.47	270	ERD1CM121E11OT
	150	6.3×11	0.16	0.41	290	ERD1CM151E11OT
	180	8×11	0.16	0.34	370	ERD1CM181F11OT
	220	8×11	0.16	0.25	480	ERD1CM221F11OT
	270	8×11	0.16	0.21	520	ERD1CM271F11OT
	330	8×12	0.16	0.156	290	ERD1CM331F12OT
	470	10×12.5	0.16	0.124	750	ERD1CM471G1BOT
	560	10×12.5	0.16	0.105	785	ERD1CM561G1BOT
	680	10×16	0.16	0.092	1100	ERD1CM681G16OT
	820	10×16	0.16	0.078	1140	ERD1CM821G16OT
	1000	10×20	0.16	0.065	1350	ERD1CM102G20OT
	1200	10×25	0.16	0.061	1500	ERD1CM122G25OT
	1500	12.5×20	0.16	0.060	1380	ERD1CM152W20OT
	1800	12.5×20	0.16	0.047	1800	ERD1CM182W20OT
	2200	12.5×25	0.18	0.038	2000	ERD1CM222W25OT
	2700	12.5×25	0.18	0.033	2450	ERD1CM272W25OT
	3300	16×25	0.20	0.030	2790	ERD1CM332L25OT
4700	16×30	0.22	0.026	2880	ERD1CM472L30OT	
5600	16×35	0.24	0.025	2990	ERD1CM562L35OT	
6800	18×35	0.26	0.024	3200	ERD1CM682M35OT	
8200	18×35	0.30	0.024	3320	ERD1CM822M35OT	
10000	18×40	0.34	0.024	3550	ERD1CM103M40OT	
25(1E)	4.7	5×11	0.14	3.95	68	ERD1EM4R7D11OT
	5.6	5×11	0.14	3.25	75	ERD1EM5R6D11OT
	6.8	5×11	0.14	2.98	80	ERD1EM6R8D11OT
	10	5×11	0.14	2.56	85	ERD1EM100D11OT
	22	5×11	0.14	1.95	125	ERD1EM220D11OT
	33	5×11	0.14	1.42	155	ERD1EM330D11OT
	47	6.3×11	0.14	1.00	220	ERD1EM470E11OT
	56	6.3×11	0.14	0.79	250	ERD1EM560E11OT
	68	6.3×11	0.14	0.65	280	ERD1EM680E11OT
	100	6.3×11	0.14	0.35	370	ERD1EM101E11OT
	120	6.3×11	0.14	0.33	380	ERD1EM121E11OT
	150	8×11	0.14	0.31	410	ERD1EM151F11OT
	180	8×11	0.14	0.25	455	ERD1EM181F11OT
	220	8×11	0.14	0.15	550	ERD1EM221F11OT
	270	10×12.5	0.14	0.125	720	ERD1EM271G1BOT
	330	10×12.5	0.14	0.114	820	ERD1EM331G1BOT
	470	10×16	0.14	0.076	1200	ERD1EM471G16OT
	560	10×16	0.14	0.072	1250	ERD1EM561G16OT
	680	10×20	0.14	0.065	1320	ERD1EM681G20OT
	820	10×25	0.14	0.052	1530	ERD1EM821G25OT
1000	12.5×20	0.14	0.045	1650	ERD1EM102W20OT	
1200	12.5×25	0.14	0.041	1980	ERD1EM122W25OT	
1500	12.5×25	0.14	0.038	2210	ERD1EM152W25OT	
1800	16×25	0.14	0.032	2510	ERD1EM182L25OT	
2200	16×25	0.16	0.036	2650	ERD1EM222L25OT	
2700	16×25	0.16	0.031	2820	ERD1EM272L25OT	
3300	16×30	0.18	0.026	3240	ERD1EM332L30OT	
4700	16×35	0.20	0.024	3650	ERD1EM472L35OT	
5600	18×35	0.22	0.024	3720	ERD1EM562M35OT	
6800	18×40	0.24	0.024	3850	ERD1EM682M40OT	

RD series

■ STANDARD RATINGS

WV (V _{dc})	Cap (μF)	Size DxL(mm)	tan	Impedance (max/20°C, 100kHz)	Rated ripple current (mA _{RMS} /105°C, 100kHz)	Part Number
35(1V)	4.7	5x11	0.12	3.65	85	ERD1VM4R7D11OT
	5.6	5x11	0.12	3.09	92	ERD1VM5R6D11OT
	6.8	5x11	0.12	2.82	97	ERD1VM6R8D11OT
	10	5x11	0.12	2.37	105	ERD1VM100D11OT
	22	5x11	0.12	1.50	150	ERD1VM220D11OT
	33	5x11	0.12	1.21	180	ERD1VM330D11OT
	47	6.3x11	0.12	0.80	280	ERD1VM470E11OT
	56	6.3x11	0.12	0.64	310	ERD1VM560E11OT
	68	8x11	0.12	0.52	350	ERD1VM680F11OT
	100	8x11	0.12	0.25	450	ERD1VM101F11OT
	120	8x11	0.12	0.22	510	ERD1VM121F11OT
	150	8x12	0.12	0.191	540	ERD1VM151F12OT
	180	10x12.5	0.12	0.172	650	ERD1VM181G1BOT
	220	10x12.5	0.12	0.114	750	ERD1VM221G1BOT
	270	10x16	0.12	0.095	910	ERD1VM271G16OT
	330	10x16	0.12	0.079	1050	ERD1VM331G16OT
	470	10x20	0.12	0.065	1200	ERD1VM471G20OT
	560	10x25	0.12	0.061	1500	ERD1VM561G25OT
	680	12.5x20	0.12	0.056	1570	ERD1VM681W20OT
	820	12.5x20	0.12	0.048	1700	ERD1VM821W20OT
1000	12.5x25	0.12	0.042	1900	ERD1VM102W25OT	
1200	12.5x30	0.12	0.039	2130	ERD1VM122W30OT	
1500	16x25	0.12	0.036	2270	ERD1VM152L25OT	
1800	16x30	0.12	0.035	2700	ERD1VM182L30OT	
2200	16x30	0.14	0.034	2780	ERD1VM222L30OT	
2700	16x35	0.14	0.029	2850	ERD1VM272L35OT	
3300	18x35	0.16	0.026	3100	ERD1VM332M35OT	
4700	18x40	0.18	0.024	3500	ERD1VM472M40OT	
50(1H)	0.47	5x11	0.10	5.40	25	ERD1HMR47D11OT
	1	5x11	0.10	4.00	40	ERD1HM010D11OT
	2.2	5x11	0.10	2.80	55	ERD1HM2R2D11OT
	3.3	5x11	0.10	2.20	60	ERD1HM3R3D11OT
	4.7	5x11	0.10	2.00	90	ERD1HM4R7D11OT
	5.6	5x11	0.10	1.93	105	ERD1HM5R6D11OT
	6.8	5x11	0.10	1.89	110	ERD1HM6R8D11OT
	10	5x11	0.10	1.82	120	ERD1HM100D11OT
	22	6.3x11	0.10	1.25	150	ERD1HM220E11OT
	33	6.3x11	0.10	0.80	250	ERD1HM330E11OT
	47	6.3x11	0.10	0.65	290	ERD1HM470E11OT
	56	8x11	0.10	0.49	310	ERD1HM560F11OT
	68	8x11	0.10	0.33	375	ERD1HM680F11OT
	100	10x12.5	0.10	0.17	480	ERD1HM101G1BOT
	120	10x12.5	0.10	0.156	530	ERD1HM121G1BOT
	150	10x12.5	0.10	0.132	590	ERD1HM151G1BOT
	180	10x16	0.10	0.114	860	ERD1HM181G16OT
	220	10x16	0.10	0.096	830	ERD1HM221G16OT
	270	10x20	0.10	0.078	960	ERD1HM271G20OT
	330	10x25	0.10	0.065	1150	ERD1HM331G25OT
470	12.5x20	0.10	0.055	1590	ERD1HM471W20OT	
560	12.5x20	0.10	0.050	1660	ERD1HM561W20OT	
680	12.5x25	0.10	0.044	1930	ERD1HM681W25OT	
820	12.5x30	0.10	0.039	2100	ERD1HM821W30OT	
1000	16x25	0.10	0.036	2300	ERD1HM102L25OT	
1200	16x30	0.10	0.036	2650	ERD1HM122L30OT	
1500	16x35	0.10	0.034	2750	ERD1HM152L35OT	
1800	16x35	0.10	0.034	2850	ERD1HM182L35OT	
2200	18x35	0.12	0.032	3040	ERD1HM222M35OT	
2700	18x40	0.14	0.027	3070	ERD1HM272M40OT	
3300	18x40	0.16	0.025	3100	ERD1HM332M40OT	

WV (V _{dc})	Cap (μF)	Size DxL(mm)	tan	Impedance (max/20°C, 100kHz)	Rated ripple current (mA _{RMS} /105°C, 100kHz)	Part Number
63(1J)	0.47	5x11	0.09	5.4	25	ERD1JMR47D11OT
	1	5x11	0.09	4.0	33	ERD1JM010D11OT
	2.2	5x11	0.09	2.8	45	ERD1JM2R2D11OT
	3.3	5x11	0.09	2.2	58	ERD1JM3R3D11OT
	4.7	5x11	0.09	2.0	65	ERD1JM4R7D11OT
	5.6	5x11	0.09	1.9	95	ERD1JM5R6D11OT
	6.8	5x11	0.09	1.82	100	ERD1JM6R8D11OT
	10	5x11	0.09	1.75	110	ERD1JM100D11OT
	22	6.3x11	0.09	0.80	240	ERD1JM220E11OT
	33	8x11	0.09	0.61	270	ERD1JM330F11OT
	47	8x12	0.09	0.56	300	ERD1JM470F12OT
	56	8x12	0.09	0.38	330	ERD1JM560F12OT
	68	10x12.5	0.09	0.21	480	ERD1JM680G1BOT
	100	10x16	0.09	0.14	610	ERD1JM101G16OT
	120	10x16	0.09	0.13	620	ERD1JM121G16OT
	150	10x16	0.09	0.11	700	ERD1JM151G16OT
	180	10x20	0.09	0.10	800	ERD1JM181G20OT
	220	10x20	0.09	0.08	1100	ERD1JM221G20OT
	270	12.5x20	0.09	0.065	1150	ERD1JM271W20OT
	330	12.5x20	0.09	0.055	1250	ERD1JM331W20OT
470	12.5x25	0.09	0.053	1620	ERD1JM471W25OT	
560	12.5x25	0.09	0.049	1630	ERD1JM561W25OT	
680	12.5x30	0.09	0.043	1950	ERD1JM681W30OT	
820	16x25	0.09	0.038	2150	ERD1JM821L25OT	
1000	16x30	0.09	0.034	2350	ERD1JM102L30OT	
1200	16x35	0.09	0.032	2550	ERD1JM122L35OT	
1500	18x35	0.09	0.031	2710	ERD1JM152M35OT	
1800	18x40	0.09	0.027	3000	ERD1JM182M40OT	
100(1K)	0.47	5x11	0.08	5.9	20	ERD1KMR47D11OT
	1	5x11	0.08	4.4	30	ERD1KM010D11OT
	2.2	5x11	0.08	3.3	42	ERD1KM2R2D11OT
	3.3	5x11	0.08	2.8	55	ERD1KM3R3D11OT
	4.7	5x11	0.08	2.6	72	ERD1KM4R7D11OT
	5.6	5x11	0.08	2.33	100	ERD1KM5R6D11OT
	6.8	6.3x11	0.08	1.95	115	ERD1KM6R8E11OT
	10	6.3x11	0.08	1.77	130	ERD1KM100E11OT
	22	8x12	0.08	0.85	220	ERD1KM220F12OT
	33	10x12.5	0.08	0.69	320	ERD1KM330G1BOT
	47	10x12.5	0.08	0.58	370	ERD1KM470G1BOT
	56	10x16	0.08	0.42	440	ERD1KM560G16OT
	68	10x16	0.08	0.35	470	ERD1KM680G16OT
	100	10x25	0.08	0.30	560	ERD1KM101G25OT
	120	10x25	0.08	0.22	660	ERD1KM121G25OT
	150	12.5x20	0.08	0.174	780	ERD1KM151W20OT
	180	12.5x20	0.08	0.142	820	ERD1KM181W20OT
	220	12.5x25	0.08	0.130	880	ERD1KM221W25OT
	270	12.5x30	0.08	0.110	1120	ERD1KM271W30OT
	330	16x25	0.08	0.100	1440	ERD1KM331L25OT
470	16x30	0.08	0.090	1650	ERD1KM471L30OT	
560	16x35	0.08	0.085	1720	ERD1KM561L35OT	
680	18x35	0.08	0.080	1790	ERD1KM681M35OT	
820	18x35	0.08	0.071	1840	ERD1KM821M35OT	
1000	18x40	0.08	0.066	1930	ERD1KM102M40OT	

Radial Type

GH series

- Life time: +105°C 5,000~10,000 hours
- Especially designed for electronic ballast, intelligent instrument, etc.
- RoHS Compliant

Upgrade



SPECIFICATIONS

Items	Characteristics												
Category Temperature Range	-40~+105°C												
Rated Voltage Range	6.3~450 V _{dc}												
Capacitance Tolerance	±20%(M) (at 20°C, 120Hz)												
Leakage Current	6.3~100V _{dc}				160~450V _{dc}				Where, I: Max.leakage current (μA), C: Nominal capacitance (μF), V: Rated voltage (V)				
	CV	After 2 minutes I 0.01CV or 3μA Whichever is greater			I 0.01CV + 10μA (2 minutes)								
	CV 1,000												
	CV>1,000	I 0.006CV+4μA						(at 20°C)					
Dissipation Factor (tan δ)	Rated Voltage(V _{dc})	6.3	10	16							25	35	50
	tan (max.)	0.30	0.24	0.20	0.18	0.16	0.14	0.12	0.10	0.15	0.20		
	When nominal capacitance exceeds 1,000μF, add 0.02 to the value above for each 1,000μF increase. (at 20°C, 120Hz)												
Low Temperature Characteristics (Max. Impedance Ratio)	Rated Voltage(V _{dc})	6.3	10	16	25	35	50	63	100	160	200~250	350~450	
	Z(-25°C)/Z(+20°C)	5	4	3	2			3			3	6	
	Z(-40°C)/Z(+20°C)	7	5	5	4			4			7	7	
Endurance	The following specifications shall be satisfied when the capacitors are restored to 20°C after DC voltage plus the rated ripple current is applied for a specified period of time at 105°C.												
	Capacitance Change	±20% of the initial value(6.3V, 10V: ±30%)									Case Dia. (mm)	Load life (hours)	
	D.F. (tan δ)	200% of the initial specified value									ØD 6.3	5,000	-
	Leakage Current	The initial specified value									ØD=8&10	6,000	7,000
											ØD 12.5	8,000	10,000
Shelf Life	The following specifications shall be satisfied when the capacitors are restored to 20°C after exposing them for 1,000 hours at 105°C without voltage applied.												
	Capacitance Change	±20% of the initial value(6.3V, 10V: ±30%)											
	D.F. (tan δ)	200% of the initial specified value											
	Leakage Current	200% of the initial specified value											

DIMENSIONS [mm]

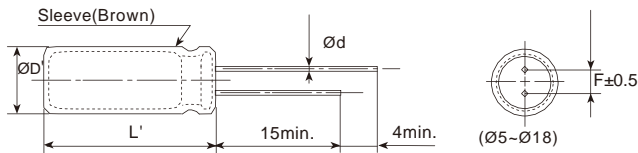

ØD	5	6.3	8	10	12.5	16	18
Ød	0.5	0.5	0.5	0.6	0.6	0.8	0.8
F	2.0	2.5	3.5	5.0	5.0	7.5	7.5
ØD'	ØD+0.5max.						
L'	L+2max.						

PART NUMBERING SYSTEM

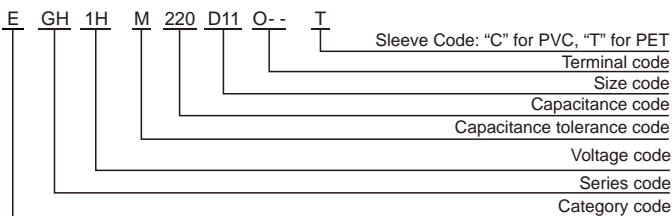

RATED RIPPLE CURRENT MULTIPLIERS

Frequency correction factor for ripple current

Cap.(μF) \ Freq.(Hz)	50/60	100/120	1k	10k	100k
Cap. 330	0.35	0.50	0.75	0.85	1.00
330<Cap. 1500	0.45	0.65	0.85	0.90	1.00
Cap.>1500	0.53	0.75	0.90	0.95	1.00

The endurance of capacitors is shortened with internal heating produced by ripple current at the rate of halving the lifetime with every 5°C rise. When long life performance is required in actual use, the rms ripple current has to be reduced.

GH series

■ STANDARD RATINGS

WV (Vdc)	Cap (µF)	Size DxDL(mm)	tan	Rated ripple current (mA _{RMS} /105°C, 100kHz)	Part Number
6.3(0J)	150	5x11	0.30	91	EGH0JM151D11OT
	330	6.3x11	0.30	151	EGH0JM331E11OT
	680	8x12	0.30	228	EGH0JM681F12OT
	820	10x12.5	0.30	256	EGH0JM821G1BOT
	1000	8x16	0.30	272	EGH0JM102F16OT
	1200	8x20	0.30	386	EGH0JM122F20OT
		10x16	0.30	386	EGH0JM122G16OT
	1500	10x20	0.30	513	EGH0JM152G20OT
	1800	12.5x16	0.30	513	EGH0JM182W16OT
	2200	10x25	0.32	580	EGH0JM222G25OT
	2700	10x30	0.32	630	EGH0JM272G30OT
		16x15	0.32	630	EGH0JM272L15OT
	3300	12.5x20	0.34	665	EGH0JM332W20OT
	3900	12.5x25	0.34	807	EGH0JM392W25OT
		18x15	0.34	807	EGH0JM392M15OT
	4700	12.5x30	0.36	902	EGH0JM472W30OT
	5600	12.5x35	0.38	1034	EGH0JM562W35OT
		16x20	0.38	1034	EGH0JM562L20OT
	6800	12.5x40	0.40	1190	EGH0JM682W40OT
		16x25	0.40	1190	EGH0JM682L25OT
18x20		0.40	1190	EGH0JM682M20OT	
8200	16x30	0.44	1400	EGH0JM822L30OT	
10000	16x35	0.48	1600	EGH0JM103L35OT	
	18x25	0.48	1600	EGH0JM103M25OT	
12000	16x40	0.52	1850	EGH0JM123L40OT	
	18x30	0.52	1850	EGH0JM123M30OT	
15000	18x35	0.58	1850	EGH0JM153M35OT	
18000	18x40	0.64	2000	EGH0JM183M40OT	
10(1A)	100	5x11	0.24	91	EGH1AM101D11OT
	220	6.3x11	0.24	151	EGH1AM221E11OT
	470	8x12	0.24	228	EGH1AM471F12OT
	680	8x16	0.24	256	EGH1AM681F16OT
		10x12.5	0.24	272	EGH1AM681G1BOT
	1000	8x20	0.24	400	EGH1AM102F20OT
		10x16	0.24	430	EGH1AM102G16OT
	1200	10x20	0.24	513	EGH1AM122G20OT
	1500	10x25	0.24	580	EGH1AM152G25OT
		12.5x16	0.24	580	EGH1AM152W16OT
	2200	10x30	0.26	630	EGH1AM222G30OT
		12.5x20	0.26	681	EGH1AM222W20OT
		16x15	0.26	681	EGH1AM222L15OT
	2700	18x15	0.26	807	EGH1AM272M15OT
	3300	12.5x25	0.28	807	EGH1AM332W25OT
	3900	12.5x30	0.28	902	EGH1AM392W30OT
		16x20	0.28	902	EGH1AM392L20OT
	4700	16x25	0.30	1116	EGH1AM472L25OT
	5600	12.5x40	0.32	1190	EGH1AM562W40OT
		16x25	0.32	1190	EGH1AM562L25OT
18x20		0.32	1190	EGH1AM562M20OT	
6800	16x30	0.34	1400	EGH1AM682L30OT	
	18x25	0.34	1400	EGH1AM682M25OT	
8200	16x35	0.38	1600	EGH1AM822L35OT	
	18x30	0.38	1600	EGH1AM822M30OT	
10000	16x40	0.42	1850	EGH1AM103L40OT	
	18x35	0.42	1850	EGH1AM103M35OT	
12000	18x40	0.46	2000	EGH1AM123M40OT	

WV (Vdc)	Cap (µF)	Size DxDL(mm)	tan	Rated ripple current (mA _{RMS} /105°C, 100kHz)	Part Number
16(1C)	56	5x11	0.20	100	EGH1CM560D11OT
	120	6.3x11	0.20	118	EGH1CM121E11OT
	330	8x12	0.20	205	EGH1CM331F12OT
	470	8x16	0.20	256	EGH1CM471F16OT
		10x12.5	0.20	272	EGH1CM471G1BOT
	680	8x20	0.20	386	EGH1CM681F20OT
		10x16	0.20	386	EGH1CM681G16OT
	1000	10x20	0.20	513	EGH1CM102G20OT
		12.5x16	0.20	513	EGH1CM102W16OT
	1200	10x25	0.20	580	EGH1CM122G25OT
		10x30	0.20	630	EGH1CM152G30OT
	1500	12.5x20	0.20	665	EGH1CM152W20OT
		16x15	0.20	665	EGH1CM152L15OT
	2200	12.5x25	0.22	807	EGH1CM222W25OT
		18x15	0.22	807	EGH1CM222M15OT
	2700	12.5x30	0.22	902	EGH1CM272W30OT
		16x20	0.22	902	EGH1CM272L20OT
	3300	12.5x35	0.24	1034	EGH1CM332W35OT
		12.5x40	0.24	1190	EGH1CM392W40OT
		16x25	0.24	1190	EGH1CM392L25OT
3900	18x20	0.24	1190	EGH1CM392M20OT	
	16x30	0.26	1400	EGH1CM472L30OT	
	18x25	0.26	1400	EGH1CM472M25OT	
5600	16x35	0.28	1600	EGH1CM562L35OT	
	18x30	0.28	1600	EGH1CM562M30OT	
6800	16x40	0.30	1850	EGH1CM682L40OT	
8200	18x35	0.34	1850	EGH1CM822M35OT	
10000	18x40	0.38	2000	EGH1CM103M40OT	
25(1E)	47	5x11	0.18	124	EGH1EM470D11OT
	100	6.3x11	0.18	138	EGH1EM101E11OT
	220	8x12	0.18	205	EGH1EM221F12OT
	330	8x16	0.18	225	EGH1EM331F16OT
		10x12.5	0.18	245	EGH1EM331G1BOT
	470	8x20	0.18	320	EGH1EM471F20OT
		10x16	0.18	340	EGH1EM471G16OT
	680	10x20	0.18	345	EGH1EM681G20OT
		12.5x16	0.18	345	EGH1EM681W16OT
	820	10x25	0.18	450	EGH1EM821G25OT
		10x30	0.18	540	EGH1EM102G30OT
	1000	12.5x20	0.18	540	EGH1EM102W20OT
		16x15	0.18	540	EGH1EM102L15OT
		18x15	0.18	560	EGH1EM122M15OT
	1500	12.5x25	0.18	665	EGH1EM152W25OT
	1800	12.5x30	0.18	790	EGH1EM182W30OT
		16x20	0.18	800	EGH1EM182L20OT
	2200	12.5x35	0.20	860	EGH1EM222W35OT
		18x20	0.20	880	EGH1EM222M20OT
	2700	12.5x40	0.20	960	EGH1EM272W40OT
16x25		0.20	980	EGH1EM272L25OT	
3300	16x30	0.22	1190	EGH1EM332L30OT	
	18x25	0.22	1190	EGH1EM332M25OT	
3900	16x35	0.22	1400	EGH1EM392L35OT	
	18x30	0.22	1400	EGH1EM392M30OT	
4700	16x40	0.24	1600	EGH1EM472L40OT	
	18x35	0.24	1600	EGH1EM472M35OT	
5600	18x40	0.26	1850	EGH1EM562M40OT	

Radial Type

GH series

■ STANDARD RATINGS

WV (Vdc)	Cap (μF)	Size DxL(mm)	tan	Rated ripple current (mA _{rms} /105°C, 100kHz)	Part Number
35(1V)	33	5x11	0.16	90	EGH1VM330D11OT
	56	6.3x11	0.16	110	EGH1VM560E11OT
	150	8x12	0.16	180	EGH1VM151F12OT
		8x16	0.16	240	EGH1VM221F16OT
	220	10x12.5	0.16	252	EGH1VM221G1BOT
		8x20	0.16	280	EGH1VM271F20OT
	330	10x16	0.16	312	EGH1VM331G16OT
		10x20	0.16	386	EGH1VM471G20OT
	470	12.5x16	0.16	394	EGH1VM471W16OT
		10x25	0.16	450	EGH1VM561G25OT
	680	10x30	0.16	496	EGH1VM681G30OT
		12.5x20	0.16	520	EGH1VM681W20OT
		16x15	0.16	520	EGH1VM681L15OT
	1000	12.5x25	0.16	810	EGH1VM102W25OT
		18x15	0.16	810	EGH1VM102M15OT
		12.5x30	0.16	860	EGH1VM122W30OT
	1200	16x25	0.16	880	EGH1VM122L25OT
		12.5x35	0.16	880	EGH1VM152W35OT
	1800	12.5x40	0.16	960	EGH1VM182W40OT
		16x20	0.16	900	EGH1VM182L20OT
		18x20	0.16	960	EGH1VM182M20OT
	2200	16x30	0.18	1190	EGH1VM222L30OT
		18x25	0.18	1190	EGH1VM222M25OT
		16x35	0.18	1400	EGH1VM272L35OT
2700	18x30	0.18	1400	EGH1VM272M30OT	
	16x40	0.20	1600	EGH1VM332L40OT	
	18x35	0.20	1600	EGH1VM332M35OT	
3900	18x40	0.20	1850	EGH1VM392M40OT	
50(1H)	22	5x11	0.14	84	EGH1HM220D11OT
	56	6.3x11	0.14	146	EGH1HM560E11OT
	100	8x12	0.14	152	EGH1HM101F12OT
	120	8x16	0.14	180	EGH1HM121F16OT
	150	10x12.5	0.14	215	EGH1HM151G1BOT
	180	8x20	0.14	246	EGH1HM181F20OT
	220	10x16	0.14	291	EGH1HM221G16OT
		10x20	0.14	330	EGH1HM271G20OT
	270	12.5x16	0.14	330	EGH1HM271W16OT
		10x25	0.14	386	EGH1HM331G25OT
	470	10x30	0.14	460	EGH1HM471G30OT
		12.5x20	0.14	475	EGH1HM471W20OT
		16x15	0.14	475	EGH1HM471L15OT
	560	12.5x25	0.14	520	EGH1HM561W25OT
		18x15	0.14	520	EGH1HM561M15OT
	680	12.5x30	0.14	665	EGH1HM681W30OT
		12.5x35	0.14	800	EGH1HM821W35OT
	820	16x20	0.14	800	EGH1HM821L20OT
		12.5x40	0.14	880	EGH1HM102W40OT
	1000	16x25	0.14	880	EGH1HM102L25OT
		18x20	0.14	880	EGH1HM102M20OT
		16x30	0.14	1190	EGH1HM122L30OT
	1200	18x25	0.14	1190	EGH1HM122M25OT
		16x35	0.14	1400	EGH1HM152L35OT
	1800	16x40	0.14	1600	EGH1HM182L40OT
		18x30	0.14	1600	EGH1HM182M30OT
	2200	18x35	0.16	1800	EGH1HM222M35OT
2700		18x40	0.16	1850	EGH1HM272M40OT

WV (Vdc)	Cap (μF)	Size DxL(mm)	tan	Rated ripple current (mA _{rms} /105°C, 100kHz)	Part Number	
63(1J)	15	5x11	0.12	62	EGH1JM150D11OT	
	33	6.3x11	0.12	126	EGH1JM330E11OT	
	56	8x12	0.12	198	EGH1JM560F12OT	
		8x16	0.12	246	EGH1JM820F16OT	
	82	10x12.5	0.12	252	EGH1JM820G1BOT	
		8x20	0.12	300	EGH1JM121F20OT	
	120	10x16	0.12	310	EGH1JM121G16OT	
		10x20	0.12	386	EGH1JM181G20OT	
	180	12.5x16	0.12	394	EGH1JM181W16OT	
		10x25	0.12	450	EGH1JM221G25OT	
	270	12.5x20	0.12	520	EGH1JM271W20OT	
		330	12.5x25	0.12	665	EGH1JM331W25OT
		470	12.5x30	0.12	790	EGH1JM471W30OT
	560	16x20	0.12	800	EGH1JM471L20OT	
		12.5x35	0.12	860	EGH1JM561W35OT	
		16x25	0.12	880	EGH1JM561L25OT	
	680	12.5x40	0.12	960	EGH1JM681W40OT	
		18x20	0.12	980	EGH1JM681M20OT	
	820	16x30	0.12	1190	EGH1JM821L30OT	
		18x25	0.12	1190	EGH1JM821M25OT	
	1000	16x35	0.12	1400	EGH1JM102L35OT	
		18x30	0.12	1400	EGH1JM102M30OT	
	1200	16x40	0.12	1600	EGH1JM122L40OT	
		18x35	0.12	1600	EGH1JM122M35OT	
1500		18x40	0.12	1850	EGH1JM152M40OT	
100(1K)	6.8	5x11	0.10	62	EGH1KM6R8D11OT	
	15	6.3x11	0.10	126	EGH1KM150E11OT	
	27	8x12	0.10	198	EGH1KM270F12OT	
	39	8x16	0.10	246	EGH1KM390F16OT	
	47	10x12.5	0.10	252	EGH1KM470G1BOT	
	56	8x20	0.10	300	EGH1KM560F20OT	
		10x16	0.10	330	EGH1KM680G16OT	
	82	10x20	0.10	386	EGH1KM820G20OT	
		12.5x16	0.10	394	EGH1KM820W16OT	
	100	10x25	0.10	450	EGH1KM101G25OT	
	120	12.5x20	0.10	520	EGH1KM121W20OT	
	180	12.5x25	0.10	665	EGH1KM181W25OT	
		16x20	0.10	800	EGH1KM221L20OT	
	220	12.5x30	0.10	790	EGH1KM221W30OT	
		12.5x35	0.10	860	EGH1KM271W35OT	
	270	16x25	0.10	880	EGH1KM271L25OT	
		18x20	0.10	980	EGH1KM331M20OT	
	330	12.5x40	0.10	960	EGH1KM331W40OT	
		16x30	0.10	1190	EGH1KM391L30OT	
	390	18x25	0.10	1190	EGH1KM391M25OT	
		16x35	0.10	1400	EGH1KM471L35OT	
	470	18x30	0.10	1400	EGH1KM471M30OT	
		560	16x40	0.10	1600	EGH1KM561L40OT
	680	18x35	0.10	1600	EGH1KM681M35OT	
820		18x40	0.10	1850	EGH1KM821M40OT	

GH series

■ STANDARD RATINGS

WV (Vdc)	Cap (μF)	Size DxL(mm)	tan	Rated ripple current (mA _{RMS} /105°C, 100kHz)	Part Number
160(2C)	10	8x12	0.15	150	EGH2CM100F12OTT
	12	10x12	0.15	180	EGH2CM120G12OTT
	15	10x16	0.15	230	EGH2CM150G16OTT
	22	10x16	0.15	280	EGH2CM220G16OTT
	33	10x20	0.15	350	EGH2CM330G20OTT
	39	10x20	0.15	390	EGH2CM390G20OTT
	47	10x20	0.15	440	EGH2CM470G20OTT
		12.5x20	0.15	480	EGH2CM470W20OTT
	56	12.5x20	0.15	600	EGH2CM560W20OTT
	68	12.5x20	0.15	740	EGH2CM680W20OTT
	82	12.5x20	0.15	780	EGH2CM820W20OTT
		16x20	0.15	800	EGH2CM820L20OTT
	100	12.5x25	0.15	860	EGH2CM101W25OTT
		16x20	0.15	860	EGH2CM101L20OTT
	150	16x20	0.15	1000	EGH2CM151L20OTT
		16x25	0.15	1040	EGH2CM151L25OTT
220	16x25	0.15	1560	EGH2CM221L25OTT	
	18x25	0.15	1600	EGH2CM221M25OTT	
330	18x30	0.15	1880	EGH2CM331M30OTT	
200(2D)	10	10x16	0.15	170	EGH2DM100G16OTT
	12	10x16	0.15	200	EGH2DM120G16OTT
	15	10x16	0.15	236	EGH2DM150G16OTT
	22	10x20	0.15	280	EGH2DM220G20OTT
	33	10x20	0.15	320	EGH2DM330G20OTT
		12.5x20	0.15	340	EGH2DM330W20OTT
	39	12.5x20	0.15	400	EGH2DM390W20OTT
	47	12.5x20	0.15	500	EGH2DM470W20OTT
	68	12.5x20	0.15	620	EGH2DM680W20OTT
		12.5x25	0.15	660	EGH2DM680W25OTT
	82	16x20	0.15	760	EGH2DM820L20OTT
		16x20	0.15	840	EGH2DM101L20OTT
	100	16x25	0.15	880	EGH2DM101L25OTT
		16x25	0.15	1160	EGH2DM151L25OTT
	150	16x30	0.15	1200	EGH2DM151L30OTT
		18x25	0.15	1200	EGH2DM151M25OTT
220	18x25	0.15	1400	EGH2DM221M25OTT	
	18x30	0.15	1440	EGH2DM221M30OTT	
330	18x35	0.15	1800	EGH2DM331M35OTT	
	18x40	0.15	1840	EGH2DM331M40OTT	
250(2E)	4.7	8x12	0.15	116	EGH2EM4R7F12OTT
	5.6	10x12	0.15	130	EGH2EM5R6G12OTT
	6.8	10x12	0.15	144	EGH2EM6R8G12OTT
	10	10x20	0.15	200	EGH2EM100G20OTT
	22	10x20	0.15	336	EGH2EM220G20OTT
	33	12.5x20	0.15	420	EGH2EM330W20OTT
	39	12.5x20	0.15	496	EGH2EM390W20OTT
	47	12.5x20	0.15	600	EGH2EM470W20OTT
		12.5x25	0.15	640	EGH2EM470W25OTT
	68	16x20	0.15	800	EGH2EM680L20OTT
		16x20	0.15	880	EGH2EM820L20OTT
	82	16x30	0.15	920	EGH2EM820L30OTT
		16x25	0.15	1020	EGH2EM101L25OTT
	100	18x25	0.15	1060	EGH2EM101M25OTT
		18x25	0.15	1200	EGH2EM151M25OTT
	220	18x31	0.15	1440	EGH2EM221M31OTT
18x40		0.15	1480	EGH2EM221M40OTT	

WV (Vdc)	Cap (μF)	Size DxL(mm)	tan	Rated ripple current (mA _{RMS} /105°C, 100kHz)	Part Number
350(2V)	4.7	8x12	0.20	110	EGH2VM4R7F12OTT
	5.6	10x12	0.20	130	EGH2VM5R6G12OTT
	6.8	10x12	0.20	160	EGH2VM6R8G12OTT
	10	10x16	0.20	200	EGH2VM100G16OTT
	22	12.5x20	0.20	364	EGH2VM220W20OTT
	33	16x20	0.20	480	EGH2VM330L20OTT
	39	16x20	0.20	530	EGH2VM390L20OTT
		16x20	0.20	580	EGH2VM470L20OTT
	47	16x25	0.20	610	EGH2VM470L25OTT
		16x25	0.20	740	EGH2VM680L25OTT
	68	18x20	0.20	740	EGH2VM680M20OTT
		18x25	0.20	780	EGH2VM680M25OTT
	82	18x25	0.20	860	EGH2VM820M25OTT
		18x25	0.20	960	EGH2VM101M25OTT
	100	18x30	0.20	1000	EGH2VM101M30OTT
		18x30	0.20	1100	EGH2VM121M30OTT
150	18x35	0.20	1200	EGH2VM151M35OTT	
400(2G)	1	8x12	0.20	50	EGH2GM010F12OTT
	2.2	8x12	0.20	70	EGH2GM2R2F12OTT
	3.3	10x12	0.20	110	EGH2GM3R3G12OTT
	4.7	10x12	0.20	130	EGH2GM4R7G12OTT
	6.8	10x12	0.20	150	EGH2GM6R8G12OTT
	10	10x16	0.20	200	EGH2GM100G16OTT
	15	12.5 x 20	0.20	270	EGH2GM150W20OTT
		12.5x20	0.20	350	EGH2GM220W20OTT
	22	12.5x25	0.20	370	EGH2GM220W25OTT
		16x20	0.20	510	EGH2GM330L20OTT
	39	16x25	0.20	580	EGH2GM390L25OTT
		16x25	0.20	660	EGH2GM470L25OTT
	47	18x20	0.20	660	EGH2GM470M20OTT
		16x30	0.20	700	EGH2GM470L30OTT
	56	10x50	0.20	780	EGH2GM560G50OTT
		12.5x40	0.20	880	EGH2GM680W40OTT
68	18x25	0.20	880	EGH2GM680M25OTT	
	12.5x45	0.20	900	EGH2GM820W45OTT	
82	18x25	0.20	960	EGH2GM820M25OTT	
	18x30	0.20	1000	EGH2GM820M30OTT	
100	12.5x50	0.20	1100	EGH2GM101W50OTT	
	18x31	0.20	1100	EGH2GM101M31OTT	
18x35	0.20	1140	EGH2GM101M35OTT		
	120	18x35	0.20	1260	EGH2GM121M35OTT
150	18x40	0.20	1400	EGH2GM151M40OTT	
450(2W)	6.8	10x16	0.20	150	EGH2WM6R8G16OTT
	10	10x20	0.20	200	EGH2WM100G20OTT
	15	12.5x20	0.20	270	EGH2WM150W20OTT
	22	16x20	0.20	370	EGH2WM220L20OTT
		10x40	0.20	510	EGH2WM330G40OTT
	33	16x25	0.20	520	EGH2WM330L25OTT
		18x20	0.20	550	EGH2WM330M20OTT
	39	10x45	0.20	620	EGH2WM390G45OTT
		18x25	0.20	620	EGH2WM390M25OTT
	47	12.5x40	0.20	700	EGH2WM470W40OTT
		18x25	0.20	700	EGH2WM470M25OTT
	56	12.5x40	0.20	780	EGH2WM560W40OTT
	68	18x30	0.20	880	EGH2WM680M30OTT
	82	12.5x50	0.20	1000	EGH2WM820W50OTT
		18x35	0.20	1000	EGH2WM820M35OTT
	100	18x40	0.20	1120	EGH2WM101M40OTT

Radial Type

LL series

- Stable and extremely low leakage current characteristics
- Endurance: +105°C 2,000 hours
- Wide temperature range of -40°C~+105°C
- **RoHS Compliant**



SPECIFICATIONS

Items	Characteristics	
Category Temperature Range	-40~+105°C	
Rated Voltage Range	6.3~100 V _{dc}	
Capacitance Tolerance	±20%(M) (at 20°C, 120Hz)	
Leakage Current	1 0.002CV or 0.4μA, whichever is greater. Where, I:Max.leakage current (μA), C:Nominal capacitance (μF), V: Rated voltage (V) (at 20°C after 2 minutes)	
Dissipation Factor (tan δ)	Rated Voltage(V _{dc})	6.3 10 16 25 35 50 63 100
	tan δ (max.)	0.22 0.19 0.16 0.14 0.12 0.10 0.10 0.10
	When nominal capacitance exceeds 1,000μF, add 0.02 to the value above for each 1,000μF increase. (at 20°C, 120Hz)	
Low Temperature Characteristics (Max. Impedance Ratio)	Rated Voltage(V _{dc})	6.3 10 16 25 35 50 63 100
	Z(-25°C)/Z(+20°C)	4 3 3 2 2 2 2 2
	Z(-40°C)/Z(+20°C)	8 6 6 4 4 3 3 3 (at 120Hz)
Endurance	The following specifications shall be satisfied when the capacitors are restored to 20 °C after DC voltage plus the rated ripple current is applied for 2,000 hours at 105 °C.	
	Capacitance Change	±20% of the initial value
	D.F. (tan δ)	200% of the initial specified value
	Leakage Current	The initial specified value
Shelf Life	The following specifications shall be satisfied when the capacitors are restored to 20°C after exposing them for 500 hours at 105°C without voltage applied.	
	Capacitance Change	±20% of the initial value
	D.F. (tan δ)	200% of the initial specified value
	Leakage Current	200% of the initial specified value

DIMENSIONS[mm]

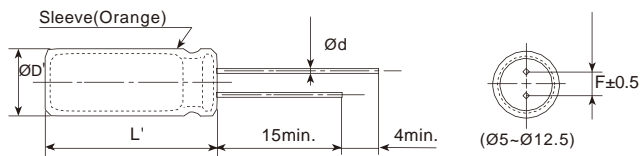

ØD	5	6.3	8	10	12.5
Ød	0.5	0.5	0.5	0.6	0.6
F	2.0	2.5	3.5	5.0	5.0
ØD'	ØD+0.5max.				
L'	L+2max.				

PART NUMBERING SYSTEM

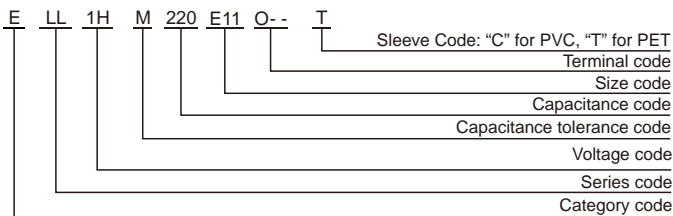

RATED RIPPLE CURRENT MULTIPLIERS

Frequency correction factor for ripple current

Freq.(Hz) Cap.(μF)	50(60)	120	1k	10k	100k
Cap.<100	0.80	1.00	1.45	1.65	1.70
100 Cap.<1000	0.80	1.00	1.36	1.48	1.53
Cap. 1000	0.85	1.00	1.25	1.35	1.38

The endurance of capacitors is shortened with internal heating produced by ripple current at the rate of halving the lifetime with every 5°C rise. When long life performance is required in actual use, the rms ripple current has to be reduced.

LL series

■ STANDARD RATINGS

WV (V _{dc})	Cap (µF)	Size DxL(mm)	tan	Rated ripple current (mA _{rms} /105°C, 120Hz)	Part Number
6.3(0J)	22	5x11	0.22	36	ELL0JM220D11OT
	33	5x11	0.22	44	ELL0JM330D11OT
	47	5x11	0.22	53	ELL0JM470D11OT
	100	5x11	0.22	74	ELL0JM101D11OT
	220	6.3x11	0.22	131	ELL0JM221E11OT
	330	6.3x11	0.22	161	ELL0JM331E11OT
	470	8x11	0.22	242	ELL0JM471F11OT
	1000	10x12	0.22	390	ELL0JM102G12OT
	2200	12.5x20	0.24	665	ELL0JM222W20OT
10(1A)	22	5x11	0.19	50	ELL1AM220D11OT
	33	5x11	0.19	66	ELL1AM330D11OT
	47	5x11	0.19	75	ELL1AM470D11OT
	100	5x11	0.19	104	ELL1AM101D11OT
	220	8x11	0.19	193	ELL1AM221F11OT
	330	8x11	0.19	256	ELL1AM331F11OT
	470	8x11	0.19	319	ELL1AM471F11OT
	1000	10x16	0.19	605	ELL1AM102G16OT
	2200	12.5x20	0.21	860	ELL1AM222W20OT
16(1C)	10	5x11	0.16	39	ELL1CM100D11OT
	22	5x11	0.16	62	ELL1CM220D11OT
	33	5x11	0.16	68	ELL1CM330D11OT
	47	5x11	0.16	105	ELL1CM470D11OT
	100	6.3x11	0.16	138	ELL1CM101E11OT
	220	8x11	0.16	220	ELL1CM221F11OT
	330	8x11	0.16	268	ELL1CM331F11OT
	470	10x12	0.16	407	ELL1CM471G12OT
	1000	10x20	0.16	704	ELL1CM102G20OT
	2200	12.5x25	0.18	890	ELL1CM222W25OT
25(1E)	4.7	5x11	0.14	32	ELL1EM4R7D11OT
	10	5x11	0.14	43	ELL1EM100D11OT
	22	5x11	0.14	65	ELL1EM220D11OT
	33	5x11	0.14	76	ELL1EM330D11OT
	47	6.3x11	0.14	116	ELL1EM470E11OT
	100	8x11	0.14	149	ELL1EM101F11OT
	220	10x12	0.14	246	ELL1EM221G12OT
	330	10x12	0.14	352	ELL1EM331G12OT
	470	10x16	0.14	484	ELL1EM471G16OT
	1000	12.5x20	0.14	847	ELL1EM102W20OT
35(1V)	4.7	5x11	0.12	33	ELL1VM4R7D11OT
	10	5x11	0.12	48	ELL1VM100D11OT
	22	6.3x11	0.12	71	ELL1VM220E11OT
	33	6.3x11	0.12	83	ELL1VM330E11OT
	47	6.3x11	0.12	125	ELL1VM470E11OT
	100	8x11	0.12	187	ELL1VM101F11OT
	220	10x12	0.12	330	ELL1VM221G12OT
	330	10x16	0.12	440	ELL1VM331G16OT
	470	12.5x20	0.12	590	ELL1VM471W20OT
	1000	12.5x25	0.12	1012	ELL1VM102W25OT

LL series

■ STANDARD RATINGS

WV (V _{dc})	Cap (μF)	Size DxL(mm)	tan	Rated ripple current (mA _{rms} /105°C, 120Hz)	Part Number
50(1H)	0.47	5x11	0.10	12	ELL1HMR47D11OT
	1	5x11	0.10	17	ELL1HM010D11OT
	2.2	5x11	0.10	24	ELL1HM2R2D11OT
	3.3	5x11	0.10	29	ELL1HM3R3D11OT
	4.7	5x11	0.10	36	ELL1HM4R7D11OT
	10	5x11	0.10	52	ELL1HM100D11OT
	22	6.3x11	0.10	77	ELL1HM220E11OT
	33	6.3x11	0.10	99	ELL1HM330E11OT
	47	8x11	0.10	138	ELL1HM470F11OT
	100	10x12	0.10	217	ELL1HM101G12OT
	220	10x20	0.10	380	ELL1HM221G20OT
	330	12.5x20	0.10	506	ELL1HM331W20OT
	470	12.5x25	0.10	705	ELL1HM471W25OT
63(1J)	0.47	5x11	0.10	12	ELL1JMR47D11OT
	1	5x11	0.10	17	ELL1JM010D11OT
	2.2	5x11	0.10	24	ELL1JM2R2D11OT
	3.3	5x11	0.10	32	ELL1JM3R3D11OT
	4.7	5x11	0.10	39	ELL1JM4R7D11OT
	10	6.3x11	0.10	58	ELL1JM100E11OT
	22	6.3x11	0.10	94	ELL1JM220E11OT
	33	8x11	0.10	110	ELL1JM330F11OT
	47	8x11	0.10	152	ELL1JM470F11OT
	100	10x16	0.10	260	ELL1JM101G16OT
	220	10x20	0.10	440	ELL1JM221G20OT
	330	12.5x20	0.10	594	ELL1JM331W20OT
	100(1K)	0.47	5x11	0.10	12
1		5x11	0.10	17	ELL1KM010D11OT
2.2		5x11	0.10	24	ELL1KM2R2D11OT
3.3		5x11	0.10	32	ELL1KM3R3D11OT
4.7		6.3x11	0.10	39	ELL1KM4R7E11OT
10		8x11	0.10	61	ELL1KM100F11OT
22		8x11	0.10	106	ELL1KM220F11OT
33		10x12	0.10	142	ELL1KM330G12OT
47		10x16	0.10	184	ELL1KM470G16OT
100		12.5x20	0.10	300	ELL1KM101W20OT
220		12.5x30	0.10	533	ELL1KM221W30OT

BG series

- SRS car assembly, high capacitance
- Low impedance, low temperature characteristics
- Endurance: +105°C 5,000 hours
- RoHS Compliant



SPECIFICATIONS

Items	Characteristics		
Category Temperature Range	-55~+105°C		
Rated Voltage Range	25 and 35 V _{dc}		
Capacitance Tolerance	±20%(M) (at 20°C, 120Hz)		
Leakage Current	I ≤ 0.01CV or 3μA, whichever is greater. Where, I: Max.leakage current (μA), C: Nominal capacitance (μF), V: Rated voltage (V) (at 20°C after 2 minutes)		
Dissipation Factor (tan δ)	Rated Voltage (V _{dc})	25	35
	tan δ (max.)	0.20	0.16
When nominal capacitance exceeds 1,000μF, add 0.02 to the value above for each 1,000μF increase. (at 20°C, 120Hz)			
Low Temperature Characteristics (Max. Impedance Ratio)	Rated Voltage (V _{dc})	25	35
	Z(-55°C)/Z(+20°C)	3	3
Endurance	The following specifications shall be satisfied when the capacitors are restored to 20°C after the rated voltage is applied for 5,000 hours at 105°C.		
	Capacitance Change	±20% of the initial value	
	D.F. (tan δ)	200% of the initial specified value	
	Leakage Current	The initial specified value	
Shelf Life	The following specifications shall be satisfied when the capacitors are restored to 20°C after exposing them for 1,000 hours at 105°C without voltage applied.		
	Capacitance Change	±20% of the initial value	
	D.F. (tan δ)	200% of the initial specified value	
	Leakage Current	200% of the initial specified value	

DIMENSIONS [mm]

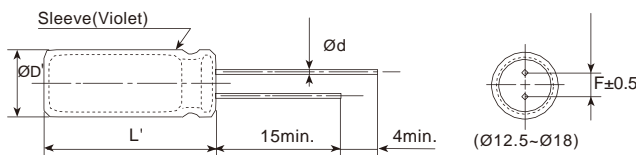

ØD	12.5	14.5	16	18
Ød	0.6	0.8	0.8	0.8
F	5.0	7.5	7.5	7.5
ØD'	ØD+0.5max.			
L'	L+2.0max.			

PART NUMBERING SYSTEM

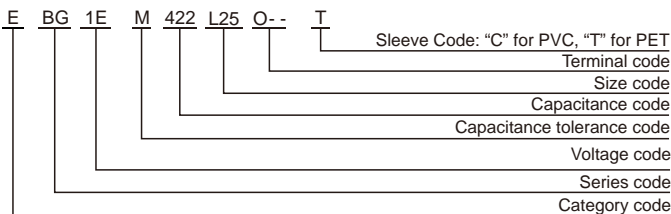

RATED RIPPLE CURRENT MULTIPLIERS

Frequency correction factor for ripple current

Freq.(Hz)	120	1k	10k	100k
Cap.<2100	0.60	0.87	0.95	1.00
2100 Cap.<4000	0.75	0.90	0.95	1.00
Cap. 4000	0.85	0.95	0.98	1.00

The endurance of capacitors is shortened with internal heating produced by ripple current at the rate of halving the lifetime with every 5°C rise. When long life performance is required in actual use, the rms ripple current has to be reduced.

BG series

■ STANDARD RATINGS

WV (V _{dc})	Cap (μF)	Size DxL(mm)	tan	Impedance (max/20°C,100kHz)	Rated ripple current (mArms/105°C,100kHz)	Part Number
25(1E)	1700	12.5x20	0.20	0.057	1700	EBG1EM172W20OT
	2400	12.5x25	0.22	0.045	2000	EBG1EM242W25OT
		14.5x20	0.22	0.051	2000	EBG1EM242X20OT
	2800	12.5x30	0.22	0.039	2300	EBG1EM282W30OT
	3000	16x20	0.24	0.044	2250	EBG1EM302L20OT
	3400	14.5x25	0.24	0.041	2400	EBG1EM342X25OT
	3500	12.5x35	0.24	0.033	2700	EBG1EM352W35OT
	4200	16x25	0.26	0.033	2600	EBG1EM422L25OT
		18x20	0.26	0.042	2500	EBG1EM422M20OT
	4500	12.5x40	0.26	0.027	3100	EBG1EM452W40OT
	4600	14.5x30	0.26	0.032	2700	EBG1EM462X30OT
	5400	14.5x35	0.28	0.028	3100	EBG1EM542X35OT
	5600	16x30	0.28	0.026	3200	EBG1EM562L30OT
	6000	18x25	0.30	0.030	2800	EBG1EM602M25OT
	6400	14.5x40	0.30	0.025	3400	EBG1EM642X40OT
	6600	16x35	0.30	0.023	3500	EBG1EM662L35OT
	7800	16x40	0.32	0.021	3800	EBG1EM782L40OT
	7900	18x30	0.32	0.024	3500	EBG1EM792M30OT
	9200	18x35	0.36	0.022	3700	EBG1EM922M35OT
11000	18x40	0.38	0.020	4000	EBG1EM113M40OT	
35(1V)	1000	12.5x20	0.16	0.057	1700	EBG1VM102W20OT
	1400	12.5x25	0.16	0.045	2000	EBG1VM142W25OT
		14.5x20	0.16	0.051	2000	EBG1VM142X20OT
	1600	12.5x30	0.16	0.039	2300	EBG1VM162W30OT
	1800	16x20	0.16	0.044	2250	EBG1VM182L20OT
	2000	14.5x25	0.18	0.041	2400	EBG1VM202X25OT
	2100	12.5x35	0.18	0.033	2700	EBG1VM212W35OT
	2500	16x25	0.18	0.033	2600	EBG1VM252L25OT
		18x20	0.18	0.042	2500	EBG1VM252M20OT
	2700	12.5x40	0.18	0.027	3100	EBG1VM272W40OT
	2800	14.5x30	0.18	0.032	2700	EBG1VM282X30OT
	3200	14.5x35	0.20	0.028	3100	EBG1VM322X35OT
	3400	16x30	0.20	0.026	3200	EBG1VM342L30OT
	3600	18x25	0.20	0.030	2800	EBG1VM362M25OT
	3800	14.5x40	0.20	0.025	3400	EBG1VM382X40OT
	4000	16x35	0.22	0.023	3500	EBG1VM402L35OT
	4700	16x40	0.22	0.021	3800	EBG1VM472L40OT
	4800	18x30	0.22	0.024	3500	EBG1VM482M30OT
	5600	18x35	0.24	0.022	3700	EBG1VM562M35OT
6700	18x40	0.24	0.020	4000	EBG1VM672M40OT	

BH series

- Endurance: +130°C 3,000 hours
- High reliability, suited for automobile electronics
- Miniaturized, long life, low impedance
- RoHS Compliant



SPECIFICATIONS

Items	Characteristics	
Category Temperature Range	-40~+130°C	
Rated Voltage Range	25~400 V _{dc}	
Capacitance Tolerance	±20%(M) (at 20°C, 120Hz)	
Leakage Current	25~100 V _{dc}	160~400 V _{dc}
	I 0.03CV or 4μA.(after 2 minutes) whichever is greater.	I 0.1CV+40μA. (after 1 minute) I 0.04CV+100μA. (after 1 minute)
Where, I: Max.leakage current (μA), C :nominal capacitance (μF), V : Rated voltage (V) (at 20°C)		
Dissipation Factor (tan δ)	Rated Voltage (V _{dc})	25 35 50 63 80 100 160~250 350~400
	tan (max.)	0.14 0.12 0.10 0.10 0.08 0.08 0.15 0.20
When nominal capacitance exceeds 1,000μF, add 0.02 to the value above for each 1,000μF increase. (at 20°C, 120Hz)		
Low Temperature Characteristics (Max. Impedance Ratio)	Rated Voltage (V _{dc})	25 35 50 63 80 100 160~250 350~400
	Z(-25°C)/Z(+20°C)	2 2 2 2 2 2 3 6
	Z(-40°C)/Z(+20°C)	4 4 4 4 4 4 6 12 (at 120Hz)
Endurance	The following specifications shall be satisfied when the capacitors are restored to 20°C after DC voltage plus rated ripple current is applied for 3,000 hours at 130°C.	
	Rated Voltage (V _{dc})	25~100 160~400
	Capacitance Change	±30% of the initial value ±20% of the initial value
	D.F. (tan δ)	300% of the initial specified value 200% of the initial specified value
	Leakage Current	The initial specified value The initial specified value
Shelf Life	The following specifications shall be satisfied when the capacitors are restored to 20°C after exposing them for 1,000 hours at 105°C without voltage applied.	
	Capacitance Change	±20% of the initial value
	D.F. (tan δ)	200% of the initial specified value
	Leakage Current	200% of the initial specified value

DIMENSIONS [mm]

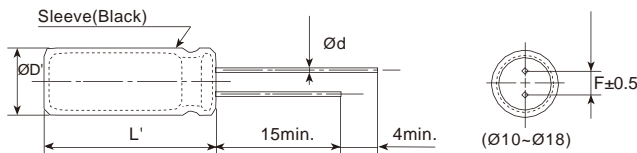

ØD	10	12.5	14.5	16	18
Ød	0.6	0.6	0.8	0.8	0.8
F	5.0	5.0	7.5	7.5	7.5
ØD'	ØD+0.5max.				
L'	L+2max.				

PART NUMBERING SYSTEM

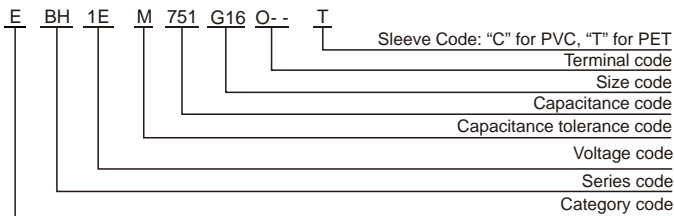

RATED RIPPLE CURRENT MULTIPLIERS

Frequency correction factor for ripple current
6.3 to 100 V_{dc}

Cap.(μF)	120	1k	10k	100k
130 to 240	0.40	0.82	0.93	1.00
270 to 560	0.50	0.85	0.94	1.00
620 to 2000	0.60	0.87	0.95	1.00
2200 to 4300	0.75	0.90	0.95	1.00
4700 to 11000	0.85	0.95	0.98	1.00

160 to 400 V_{dc}

Cap.(μF)	50	120	300	1k	10k	100k
12 to 33	0.15	0.30	0.45	0.65	0.95	1.00
36 to 270	0.25	0.35	0.50	0.70	0.96	1.00

The endurance of capacitors is shortened with internal heating produced by ripple current at the rate of halving the lifetime with every 5°C rise. When long life performance is required in actual use, the rms ripple current has to be reduced.

BH series

■ STANDARD RATINGS

WV (V _{dc})	Cap (μF)	Size D×L(mm)	tan	Impedance (max/20°C, 100kHz)	Rated ripple current (mArms/130°C, 100kHz)	Part Number
25(1E)	510	10×12.5	0.14	0.14	900	EBH1EM511G1BOT
	750	10×16	0.14	0.094	1300	EBH1EM751G16OT
	910	12.5×16	0.14	0.082	1220	EBH1EM911W16OT
	1200	10×20	0.14	0.073	1540	EBH1EM122G20OT
		14.5×15	0.14	0.067	1320	EBH1EM122X15OT
	1500	10×25	0.14	0.042	1880	EBH1EM152G25OT
	1600	16×15	0.14	0.063	1430	EBH1EM162L15OT
	1800	12.5×20	0.14	0.038	1590	EBH1EM182W20OT
	2000	10×30	0.16	0.033	2150	EBH1EM202G30OT
	2200	14.5×20	0.16	0.030	1780	EBH1EM222X20OT
	2400	18×15	0.16	0.053	1630	EBH1EM242M15OT
	2700	12.5×25	0.16	0.030	2280	EBH1EM272W25OT
	3000	16×20	0.18	0.029	1890	EBH1EM302L20OT
	3300	12.5×30	0.18	0.025	2760	EBH1EM332W30OT
	3600	14.5×25	0.18	0.025	2760	EBH1EM362X25OT
		12.5×35	0.20	0.022	3120	EBH1EM432W35OT
	4300	16×25	0.20	0.022	3030	EBH1EM432L25OT
		18×20	0.20	0.028	1930	EBH1EM432M20OT
	4700	14.5×30	0.20	0.020	3090	EBH1EM472X30OT
	5100	12.5×40	0.22	0.019	3610	EBH1EM512W40OT
		14.5×35	0.22	0.018	3430	EBH1EM512X35OT
		16×30	0.22	0.018	3330	EBH1EM512L30OT
	5600	18×25	0.24	0.020	3200	EBH1EM562M25OT
		14.5×40	0.24	0.016	3820	EBH1EM682X40OT
6800	16×35	0.24	0.016	3630	EBH1EM682L35OT	
	18×30	0.26	0.016	3480	EBH1EM752M30OT	
8200	16×40	0.28	0.015	3930	EBH1EM822L40OT	
9100	18×35	0.30	0.015	3750	EBH1EM912M35OT	
11000	18×40	0.32	0.014	4040	EBH1EM113M40OT	
35(1V)	300	10×12.5	0.12	0.14	900	EBH1VM301G1BOT
	510	10×16	0.12	0.094	1300	EBH1VM511G16OT
	560	12.5×16	0.12	0.082	1220	EBH1VM561W16OT
	680	10×20	0.12	0.073	1540	EBH1VM681G20OT
	750	14.5×15	0.12	0.067	1320	EBH1VM751X15OT
	820	10×25	0.12	0.042	1880	EBH1VM821G25OT
	1100	12.5×20	0.12	0.038	1590	EBH1VM112W20OT
		16×15	0.12	0.063	1430	EBH1VM112L15OT
	1200	10×30	0.12	0.033	2150	EBH1VM122G30OT
	1500	12.5×25	0.12	0.030	2280	EBH1VM152W25OT
		14.5×20	0.12	0.030	1780	EBH1VM152X20OT
	2000	18×15	0.12	0.053	1630	EBH1VM152M15OT
		12.5×30	0.14	0.025	2760	EBH1VM202W30OT
	2200	16×20	0.14	0.029	1890	EBH1VM202L20OT
		14.5×25	0.14	0.025	2760	EBH1VM222X25OT
	2400	12.5×35	0.14	0.022	3120	EBH1VM242W35OT
		16×25	0.14	0.022	3030	EBH1VM242L25OT
	2700	18×20	0.14	0.028	1930	EBH1VM242M20OT
		12.5×40	0.14	0.019	3610	EBH1VM272W40OT
	3000	14.5×30	0.14	0.020	3090	EBH1VM272X30OT
		14.5×35	0.16	0.018	3430	EBH1VM302X35OT
	3300	16×30	0.16	0.018	3330	EBH1VM332L30OT
		18×25	0.16	0.020	3200	EBH1VM332M25OT
	3900	14.5×40	0.16	0.016	3820	EBH1VM392X40OT
	4300	16×35	0.18	0.016	3630	EBH1VM432L35OT
		18×30	0.18	0.016	3480	EBH1VM432M30OT
	4700	16×40	0.18	0.015	3930	EBH1VM472L40OT
	5100	18×35	0.20	0.015	3750	EBH1VM512M35OT
	6200	18×40	0.26	0.014	4040	EBH1VM622M40OT

WV (V _{dc})	Cap (μF)	Size D×L(mm)	tan	Impedance (max/20°C, 100kHz)	Rated ripple current (mArms/130°C, 100kHz)	Part Number
50(1H)	160	10×12.5	0.10	0.24	730	EBH1HM161G1BOT
	240	10×16	0.10	0.16	1080	EBH1HM241G16OT
	270	12.5×16	0.10	0.14	1020	EBH1HM271W16OT
	330	10×20	0.10	0.12	1290	EBH1HM331G20OT
	390	14.5×15	0.10	0.12	1090	EBH1HM391X15OT
	430	10×25	0.10	0.055	1740	EBH1HM431G25OT
	510	12.5×20	0.10	0.049	1410	EBH1HM511W20OT
	560	10×30	0.10	0.041	2020	EBH1HM561G30OT
		16×15	0.10	0.11	1190	EBH1HM561L15OT
	680	14.5×20	0.10	0.038	1610	EBH1HM681X20OT
	750	12.5×25	0.10	0.038	2030	EBH1HM751W25OT
		18×15	0.10	0.085	1370	EBH1HM751M15OT
	910	16×20	0.10	0.037	1740	EBH1HM911L20OT
	1000	12.5×30	0.10	0.031	2510	EBH1HM102W30OT
		14.5×25	0.10	0.031	2480	EBH1HM102X25OT
	1200	12.5×35	0.10	0.027	2900	EBH1HM122W35OT
		18×20	0.10	0.036	1830	EBH1HM122M20OT
	1300	14.5×30	0.10	0.026	2870	EBH1HM132X30OT
		16×35	0.10	0.027	2690	EBH1HM132L35OT
	1500	12.5×40	0.10	0.023	3260	EBH1HM152W40OT
		14.5×35	0.10	0.023	3160	EBH1HM152X35OT
	1600	16×30	0.10	0.023	3150	EBH1HM162L30OT
	1800	18×25	0.10	0.025	2900	EBH1HM182M25OT
	2000	14.5×40	0.12	0.020	3560	EBH1HM202X40OT
16×35		0.12	0.020	3470	EBH1HM202L35OT	
2200	18×30	0.12	0.021	3330	EBH1HM222M30OT	
2400	16×40	0.12	0.018	3800	EBH1HM242L40OT	
2700	18×35	0.12	0.019	3590	EBH1HM272M35OT	
3300	18×40	0.14	0.017	3850	EBH1HM332M40OT	
63(1J)	390	12.5×20	0.10	0.097	1310	EBH1JM391W20OT
	510	12.5×25	0.10	0.072	1880	EBH1JM511W25OT
		14.5×20	0.10	0.072	1510	EBH1JM511X20OT
	620	16×20	0.10	0.062	1630	EBH1JM621L20OT
	680	12.5×30	0.10	0.052	2410	EBH1JM681W30OT
		14.5×25	0.10	0.054	2130	EBH1JM681X25OT
	820	12.5×35	0.10	0.044	2760	EBH1JM821W35OT
		18×20	0.10	0.055	1750	EBH1JM821M20OT
	910	14.5×30	0.10	0.042	2700	EBH1JM911X30OT
		16×25	0.10	0.047	2300	EBH1JM911L25OT
	1000	12.5×40	0.10	0.038	3080	EBH1JM102W40OT
		14.5×35	0.10	0.037	2940	EBH1JM112X35OT
	1100	16×30	0.10	0.037	2940	EBH1JM112L30OT
		18×25	0.10	0.044	2440	EBH1JM122M25OT
	1300	14.5×40	0.10	0.032	3350	EBH1JM132X40OT
		16×35	0.10	0.031	3220	EBH1JM132L35OT
1500	18×30	0.10	0.037	3100	EBH1JM152M30OT	
1800	16×40	0.10	0.028	3590	EBH1JM182L40OT	
2000	18×35	0.12	0.028	3450	EBH1JM202M35OT	
2400	18×40	0.12	0.023	3690	EBH1JM242M40OT	

BH series

■ STANDARD RATINGS

WV (V _{dc})	Cap (μF)	Size D×L(mm)	tan	Impedance (max/20°C, 100kHz)	Rated ripple current (mA _{rms} /130°C, 100kHz)	Part Number
80(1B)	240	12.5×20	0.08	0.097	1310	EBH1BM241W20OT
	330	12.5×25	0.08	0.072	1880	EBH1BM331W25OT
		14.5×20	0.08	0.072	1510	EBH1BM331X20OT
		16×20	0.08	0.062	1630	EBH1BM391L20OT
	430	12.5×30	0.08	0.052	2410	EBH1BM431W30OT
	470	14.5×25	0.08	0.054	2130	EBH1BM471X25OT
	560	12.5×35	0.08	0.044	2760	EBH1BM561W35OT
		16×25	0.08	0.047	2300	EBH1BM561L25OT
		18×20	0.08	0.055	1750	EBH1BM561M20OT
	620	12.5×40	0.08	0.038	3080	EBH1BM621W40OT
		14.5×30	0.08	0.042	2700	EBH1BM621X30OT
	680	14.5×35	0.08	0.037	2940	EBH1BM681X35OT
		16×30	0.08	0.037	2940	EBH1BM681L30OT
	750	18×25	0.08	0.044	2440	EBH1BM751M25OT
	820	14.5×40	0.08	0.032	3350	EBH1BM821X40OT
	910	16×35	0.08	0.031	3220	EBH1BM911L35OT
		18×30	0.08	0.037	3100	EBH1BM911M30OT
	1100	16×40	0.08	0.028	3590	EBH1BM112L40OT
1300	18×35	0.08	0.028	3450	EBH1BM132M35OT	
1500	18×40	0.08	0.023	3690	EBH1BM152M40OT	
100(1K)	130	12.5×20	0.08	0.12	1210	EBH1KM131W20OT
	180	14.5×20	0.08	0.082	1450	EBH1KM181X20OT
	200	12.5×25	0.08	0.082	1800	EBH1KM201W25OT
	240	12.5×30	0.08	0.062	2290	EBH1KM241W30OT
		16×20	0.08	0.071	1580	EBH1KM241L20OT
	270	14.5×25	0.08	0.064	2050	EBH1KM271X25OT
	330	12.5×35	0.08	0.051	2680	EBH1KM331W35OT
		16×25	0.08	0.057	2190	EBH1KM331L25OT
		18×20	0.08	0.069	1690	EBH1KM331M20OT
	360	14.5×30	0.08	0.050	2620	EBH1KM361X30OT
		12.5×40	0.08	0.044	2970	EBH1KM391W40OT
	390	14.5×35	0.08	0.044	2850	EBH1KM391X35OT
		16×30	0.08	0.044	2770	EBH1KM391L30OT
	430	18×25	0.08	0.054	2310	EBH1KM431M25OT
		14.5×40	0.08	0.038	3230	EBH1KM511X40OT
	510	16×35	0.08	0.037	3010	EBH1KM511L35OT
		18×30	0.08	0.043	2830	EBH1KM561M30OT
	620	16×40	0.08	0.032	3320	EBH1KM621L40OT
680	18×35	0.08	0.034	3210	EBH1KM681M35OT	
820	18×40	0.08	0.029	3410	EBH1KM821M40OT	

WV (V _{dc})	Cap (μF)	Size D×L(mm)	tan	Impedance (max/20°C, 100kHz)	Rated ripple current (mA _{rms} /130°C, 100kHz)	Part Number
160(2C)	47	12.5×25	0.15	—	590	EBH2CM470W25OT
	68	16×25	0.15	—	750	EBH2CM680L25OT
	82	16×25	0.15	—	825	EBH2CM820L25OT
	100	16×25	0.15	—	960	EBH2CM101L25OT
		18×20	0.15	—	960	EBH2CM101M20OT
	150	18×30	0.15	—	1050	EBH2CM151M30OT
	220	18×35	0.15	—	1500	EBH2CM221M35OT
200(2D)	33	12.5×20	0.15	—	500	EBH2DM330W20OT
	47	12.5×25	0.15	—	650	EBH2DM470W25OT
	68	16×20	0.15	—	650	EBH2DM470L20OT
	68	16×25	0.15	—	750	EBH2DM680L25OT
	82	16×30	0.15	—	900	EBH2DM820L30OT
		18×25	0.15	—	900	EBH2DM820M25OT
	100	16×30	0.15	—	1100	EBH2DM101L30OT
150	18×25	0.15	—	1100	EBH2DM101M25OT	
	18×35	0.15	—	1350	EBH2DM151M35OT	
250(2E)	22	12.5×20	0.15	—	430	EBH2EM220W20OT
	33	12.5×25	0.15	—	530	EBH2EM330W25OT
		16×20	0.15	—	530	EBH2EM330L20OT
	47	16×25	0.15	—	690	EBH2EM470L25OT
		18×20	0.15	—	690	EBH2EM470M20OT
	68	16×30	0.15	—	780	EBH2EM680L30OT
		18×25	0.15	—	780	EBH2EM680M25OT
82	18×25	0.15	—	900	EBH2EM820M25OT	
	100	18×30	0.15	—	970	EBH2EM101M30OT
350(2V)	15	12.5×25	0.20	—	335	EBH2VM150W25OT
		16×20	0.20	—	335	EBH2VM150L20OT
	22	16×25	0.20	—	450	EBH2VM220L25OT
		16×30	0.20	—	535	EBH2VM330L30OT
	33	16×35	0.20	—	555	EBH2VM330L35OT
		18×30	0.20	—	700	EBH2VM470M30OT
	47	18×35	0.20	—	750	EBH2VM470M35OT
68		18×40	0.20	—	900	EBH2VM680M40OT
400(2G)	12	12.5×25	0.20	—	280	EBH2GM120W25OT
	15	12.5×25	0.20	—	335	EBH2GM150W25OT
		16×20	0.20	—	335	EBH2GM150L20OT
	22	16×25	0.20	—	480	EBH2GM220L25OT
		16×30	0.20	—	500	EBH2GM220L30OT
	33	18×30	0.20	—	635	EBH2GM330M30OT
	47	18×35	0.20	—	750	EBH2GM470M35OT
68		18×40	0.20	—	900	EBH2GM680M40OT

LK series

- Standard series for general purpose
- Endurance: 2,000 hours at 85°C
- RoHS Compliant



SPECIFICATIONS

Items	Characteristics	
Category Temperature Range	-40~+85°C	-25~ +85°C
Rated Voltage Range	10~100V.DC	160~500V.DC
Capacitance Tolerance	±20% (M) (at 20°C, 120Hz)	
Leakage Current	I 3√CV Where, I: Max.leakage current (μA), C: Nominal capacitance (μF), V: Rated voltage (V) (at 20 °C after 5 minutes)	
Dissipation Factor (tan δ)	Rated Voltage (V _{dc})	10 16 25 35 50 63 80 100 160 to 400 420 to 500 (at 20°C, 120Hz)
	tan (max.)	0.55 0.50 0.45 0.40 0.35 0.30 0.25 0.20 0.15 0.15
Low Temperature Characteristics (Max. Impedance Ratio)	Rated Voltage (V _{dc})	10 16 25 35 50 63 80 100 160 to 400 420 to 500
	Z(-25°C)/Z(+20°C)	4 4 3 3 2 2 2 2 4 8
	Z(-40°C)/Z(+20°C)	15 15 10 8 6 6 5 5 - - (at 120Hz)
Endurance	The following specifications shall be satisfied when the capacitors are restored to 20°C after DC voltage plus the rated ripple current is applied for 2,000 hours at 85°C.	
	Capacitance Change	±20% of the initial value
	D.F. (tan δ)	200% of the initial specified value
	Leakage Current	The initial specified value
Shelf Life	The following specifications shall be satisfied when the capacitors are restored to 20°C after exposing them for 1,000 hours at 85°C without voltage applied.	
	Capacitance Change	±20% of the initial value
	D.F. (tan δ)	150% of the initial specified value
	Leakage Current	200% of the initial specified value

DIMENSIONS [mm]

- Terminal Code : K (22 to 35) : Standard

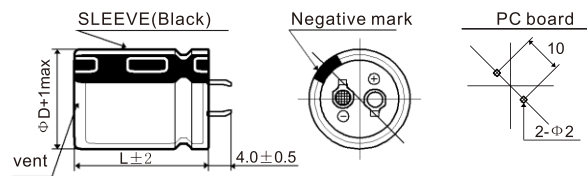

- Terminal Code: P (40 to 45)

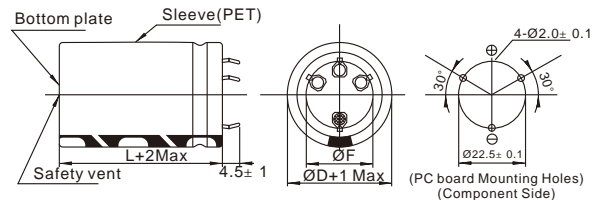

PART NUMBERING SYSTEM

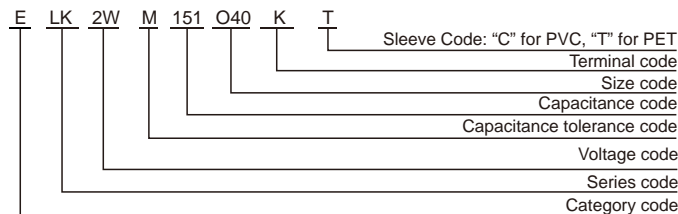

RATED RIPPLE CURRENT MULTIPLIERS

Frequency correction factor for ripple current

Rated voltage(V _{dc}) \ Freq.(Hz)	120	1k	10k	100k
10~50	1.00	1.03	1.05	1.08
63~100	1.00	1.07	1.13	1.19
160~250	1.00	1.32	1.45	1.50
315~500	1.00	1.30	1.41	1.43

The endurance of capacitors is shortened with internal heating produced by ripple current at the rate of halving the lifetime with every 5°C rise. When long life performance is required in actual use, the rms ripple current has to be reduced.

LK series

■ STANDARD RATINGS

WV (Vdc)	Cap (µF)	Size DxDL(mm)	tan	Rated ripple current (Arms/85°C, 120Hz)	Part Number
10(1A)	12000	22x25	0.55	2.41	ELK1AM123O25KT
	15000	22x30	0.55	2.88	ELK1AM153O30KT
		25x25	0.55	2.88	ELK1AM153P25KT
		22x35	0.55	3.22	ELK1AM183O35KT
	18000	25x30	0.55	3.08	ELK1AM183P30KT
		22x40	0.55	3.79	ELK1AM223O40KT
	22000	25x30	0.55	3.66	ELK1AM223P30KT
		30x25	0.55	3.53	ELK1AM223Q25KT
		22x45	0.55	4.04	ELK1AM273O45KT
	27000	25x35	0.55	4.04	ELK1AM273P35KT
		30x30	0.55	3.99	ELK1AM273Q30KT
		22x50	0.55	4.58	ELK1AM333O50KT
	33000	25x40	0.55	4.56	ELK1AM333P40KT
		30x30	0.55	4.58	ELK1AM333Q30KT
		25x45	0.55	5.29	ELK1AM393P45KT
	39000	30x35	0.55	5.21	ELK1AM393Q35KT
		35x30	0.55	5.05	ELK1AM393R30KT
		25x50	0.55	5.78	ELK1AM473P50KT
	47000	30x40	0.55	5.78	ELK1AM473Q40KT
		35x35	0.55	5.55	ELK1AM473R35KT
	56000	30x45	0.55	6.59	ELK1AM563Q45KT
		35x35	0.55	6.40	ELK1AM563R35KT
	68000	30x50	0.55	7.50	ELK1AM683Q50KT
		35x40	0.55	7.48	ELK1AM683R40KT
82000	35x50	0.55	8.50	ELK1AM823R50KT	
16(1C)	8200	22x25	0.50	2.56	ELK1CM822O25KT
	10000	22x30	0.50	2.81	ELK1CM103O30KT
		22x30	0.50	3.31	ELK1CM123O30KT
	12000	25x25	0.50	2.96	ELK1CM123P25KT
		22x35	0.50	3.69	ELK1CM153O35KT
	15000	25x30	0.50	3.64	ELK1CM153P30KT
		30x25	0.50	3.73	ELK1CM153Q25KT
		22x40	0.50	3.98	ELK1CM183O40KT
	18000	25x35	0.50	3.98	ELK1CM183P35KT
		30x30	0.50	3.88	ELK1CM183Q30KT
		22x50	0.50	4.52	ELK1CM223O50KT
	22000	25x40	0.50	4.44	ELK1CM223P40KT
		30x30	0.50	4.38	ELK1CM223Q30KT
		25x45	0.50	4.98	ELK1CM273P45KT
	27000	30x35	0.50	4.82	ELK1CM273Q35KT
		35x30	0.50	4.82	ELK1CM273R30KT
		25x50	0.50	5.49	ELK1CM333P50KT
	33000	30x40	0.50	5.38	ELK1CM333Q40KT
		35x35	0.50	5.33	ELK1CM333R35KT
		30x45	0.50	6.11	ELK1CM393Q45KT
	39000	35x35	0.50	6.01	ELK1CM393R35KT
		30x50	0.50	6.80	ELK1CM473Q50KT
	47000	35x40	0.50	6.80	ELK1CM473R40KT
		56000	35x45	0.50	7.62
25(1E)	5600	22x25	0.45	2.31	ELK1EM562O25KT
	6800	22x30	0.45	2.56	ELK1EM682O30KT
		22x35	0.45	2.81	ELK1EM822O35KT
	8200	25x25	0.45	2.78	ELK1EM822P25KT
		22x35	0.45	3.18	ELK1EM103O35KT
	10000	25x30	0.45	3.16	ELK1EM103P30KT
		22x40	0.45	3.53	ELK1EM123O40KT
	12000	25x35	0.45	3.48	ELK1EM123P35KT
		30x25	0.45	3.53	ELK1EM123Q25KT
		22x50	0.45	4.08	ELK1EM153O50KT
	15000	25x40	0.45	4.00	ELK1EM153P40KT
		30x30	0.45	4.00	ELK1EM153Q30KT

WV (Vdc)	Cap (µF)	Size DxDL(mm)	tan	Rated ripple current (Arms/85°C, 120Hz)	Part Number	
25(1E)	18000	25x45	0.45	4.68	ELK1EM183P45KT	
		30x35	0.45	4.66	ELK1EM183Q35KT	
		35x30	0.45	4.68	ELK1EM183R30KT	
	22000	30x40	0.45	5.19	ELK1EM223Q40KT	
		35x35	0.45	5.20	ELK1EM223R35KT	
		30x45	0.45	6.02	ELK1EM273Q45KT	
	27000	35x40	0.45	6.02	ELK1EM273R40KT	
		33000	35x45	0.45	6.75	ELK1EM333R45KT
		39000	35x50	0.45	7.56	ELK1EM393R50KT
35(1V)	3900	22x25	0.40	2.22	ELK1VM392O25KT	
	4700	22x30	0.40	2.46	ELK1VM472O30KT	
		25x25	0.40	2.43	ELK1VM472P25KT	
		22x35	0.40	2.79	ELK1VM562O35KT	
	5600	25x30	0.40	2.75	ELK1VM562P30KT	
		22x40	0.40	2.89	ELK1VM682O40KT	
		25x30	0.40	2.89	ELK1VM682P30KT	
	6800	30x25	0.40	3.09	ELK1VM682Q25KT	
		22x45	0.40	3.47	ELK1VM822O45KT	
		25x35	0.40	3.33	ELK1VM822P35KT	
	8200	30x30	0.40	3.29	ELK1VM822Q30KT	
		22x50	0.40	3.59	ELK1VM103O50KT	
		10000	25x40	0.40	3.59	ELK1VM103P40KT
	30x30		0.40	3.61	ELK1VM103Q30KT	
	25x45		0.40	4.01	ELK1VM123P45KT	
12000	30x35	0.40	4.01	ELK1VM123Q35KT		
	35x30	0.40	4.02	ELK1VM123R30KT		
	30x40	0.40	4.80	ELK1VM153Q40KT		
15000	35x35	0.40	4.80	ELK1VM153R35KT		
	30x45	0.40	5.18	ELK1VM183Q45KT		
	35x40	0.40	5.71	ELK1VM183R40KT		
18000	22000	35x45	0.40	6.38	ELK1VM223R45KT	
	27000	35x50	0.40	6.90	ELK1VM273R50KT	
	50(1H)	2200	22x25	0.35	1.93	ELK1HM222O25KT
2700		22x30	0.35	2.21	ELK1HM272O30KT	
		22x30	0.35	2.41	ELK1HM332O30KT	
		25x25	0.35	2.38	ELK1HM332P25KT	
3300		22x35	0.35	2.72	ELK1HM392O35KT	
		25x30	0.35	2.68	ELK1HM392P30KT	
		22x40	0.35	3.01	ELK1HM472O40KT	
3900		25x30	0.35	3.03	ELK1HM472P30KT	
		30x25	0.35	3.01	ELK1HM472Q25KT	
		22x45	0.35	3.43	ELK1HM562O45KT	
4700		25x35	0.35	3.37	ELK1HM562P35KT	
		30x30	0.35	3.43	ELK1HM562Q30KT	
	22x50	0.35	3.94	ELK1HM682O50KT		
5600	25x40	0.35	3.87	ELK1HM682P40KT		
	30x35	0.35	3.87	ELK1HM682Q35KT		
	25x45	0.35	4.37	ELK1HM822P45KT		
6800	30x35	0.35	4.42	ELK1HM822Q35KT		
	35x30	0.35	4.41	ELK1HM822R30KT		
	30x40	0.35	5.02	ELK1HM103Q40KT		
8200	35x35	0.35	4.92	ELK1HM103R35KT		
	30x50	0.35	5.60	ELK1HM123Q50KT		
	35x40	0.35	5.60	ELK1HM123R40KT		
10000	35x45	0.35	6.44	ELK1HM153R45KT		
	18000	35x50	0.35	6.71	ELK1HM183R50KT	
	63(1J)	1800	22x25	0.30	1.90	ELK1JM182O25KT
2200		22x30	0.30	2.35	ELK1JM222O30KT	
		25x25	0.30	2.30	ELK1JM222P25KT	
2700		22x35	0.30	2.50	ELK1JM272O35KT	
		25x30	0.30	2.49	ELK1JM272P30KT	

Snap-in&Lug Terminal Type

LK series

■ STANDARD RATINGS

WV (Vdc)	Cap (μF)	Size DxDL(mm)	tan	Rated ripple current (Arms/85°C, 120Hz)	Part Number	
63(1J)	3300	22x40	0.30	2.69	ELK1JM332O40KT	
		25x30	0.30	2.69	ELK1JM332P30KT	
		30x25	0.30	2.78	ELK1JM332Q25KT	
	3900	22x45	0.30	3.10	ELK1JM392O45KT	
		25x35	0.30	3.09	ELK1JM392P35KT	
		30x30	0.30	3.09	ELK1JM392Q30KT	
	4700	22x50	0.30	3.49	ELK1JM472O50KT	
		25x40	0.30	3.37	ELK1JM472P40KT	
		30x30	0.30	3.37	ELK1JM472Q30KT	
	5600	25x45	0.30	3.80	ELK1JM562P45KT	
		30x35	0.30	3.81	ELK1JM562Q35KT	
		35x30	0.30	3.75	ELK1JM562R30KT	
	6800	25x50	0.30	4.41	ELK1JM682P50KT	
		30x40	0.30	4.41	ELK1JM682Q40KT	
		35x35	0.30	4.33	ELK1JM682R35KT	
	8200	30x45	0.30	4.90	ELK1JM822Q45KT	
		35x35	0.30	4.80	ELK1JM822R35KT	
	10000	30x50	0.30	5.49	ELK1JM103Q50KT	
		35x40	0.30	5.47	ELK1JM103R40KT	
	12000	35x50	0.30	6.30	ELK1JM123R50KT	
	80(1B)	1200	22x25	0.25	1.77	ELK1BM122O25KT
		1500	22x30	0.25	2.01	ELK1BM152O30KT
		1800	22x35	0.25	2.25	ELK1BM182O35KT
			25x25	0.25	2.26	ELK1BM182P25KT
2200		22x40	0.25	2.53	ELK1BM222O40KT	
		25x30	0.25	2.53	ELK1BM222P30KT	
2700		30x25	0.25	2.50	ELK1BM222Q25KT	
		22x45	0.25	2.93	ELK1BM272O45KT	
3300		25x35	0.25	2.93	ELK1BM272P35KT	
		30x30	0.25	2.91	ELK1BM272Q30KT	
		22x50	0.25	3.25	ELK1BM332O50KT	
3900		25x40	0.25	3.25	ELK1BM332P40KT	
		30x30	0.25	3.23	ELK1BM332Q30KT	
4700		25x45	0.25	3.62	ELK1BM392P45KT	
		30x35	0.25	3.62	ELK1BM392Q35KT	
5600		25x50	0.25	4.28	ELK1BM472P50KT	
		30x40	0.25	4.15	ELK1BM472Q40KT	
6800		35x30	0.25	4.10	ELK1BM472R30KT	
		30x45	0.25	4.55	ELK1BM562Q45KT	
8200		35x35	0.25	4.51	ELK1BM562R35KT	
		30x50	0.25	5.18	ELK1BM682Q50KT	
		35x40	0.25	5.14	ELK1BM682R40KT	
		35x45	0.25	5.83	ELK1BM822R45KT	
100(1K)		820	22x25	0.20	1.86	ELK1KM821O25KT
	1000	22x30	0.20	2.02	ELK1KM102O30KT	
	1200	22x30	0.20	2.12	ELK1KM122O30KT	
		25x25	0.20	2.10	ELK1KM122P25KT	
	1500	22x35	0.20	2.45	ELK1KM152O35KT	
		25x30	0.20	2.43	ELK1KM152P30KT	
	1800	22x40	0.20	2.77	ELK1KM182O40KT	
		25x35	0.20	2.77	ELK1KM182P35KT	
	2200	30x25	0.20	2.65	ELK1KM182Q25KT	
		22x45	0.20	3.12	ELK1KM222O45KT	
	2700	25x40	0.20	3.20	ELK1KM222P40KT	
		30x30	0.20	3.10	ELK1KM222Q30KT	
	3300	25x45	0.20	3.61	ELK1KM272P45KT	
		30x35	0.20	3.60	ELK1KM272Q35KT	
	3900	35x30	0.20	3.71	ELK1KM272R30KT	
		25x50	0.20	4.06	ELK1KM332P50KT	
	4700	30x40	0.20	4.05	ELK1KM332Q40KT	
		35x35	0.20	4.07	ELK1KM332R35KT	
		30x45	0.20	4.60	ELK1KM392Q45KT	
		35x35	0.20	4.50	ELK1KM392R35KT	
		30x50	0.20	5.13	ELK1KM472Q50KT	
		35x40	0.20	5.12	ELK1KM472R40KT	

WV (Vdc)	Cap (μF)	Size DxDL(mm)	tan	Rated ripple current (Arms/85°C, 120Hz)	Part Number
100(1K)	5600	35x45	0.20	5.75	ELK1KM562R45KT
	6800	35x50	0.20	6.01	ELK1KM682R50KT
160(2C)	390	22x25	0.15	1.55	ELK2CM391O25KT
		22x30	0.15	1.77	ELK2CM471O30KT
	470	25x25	0.15	1.77	ELK2CM471P25KT
		22x35	0.15	2.05	ELK2CM561O35KT
	560	25x30	0.15	2.05	ELK2CM561P30KT
		22x40	0.15	2.24	ELK2CM681O40KT
	680	25x30	0.15	2.22	ELK2CM681P30KT
		30x25	0.15	2.22	ELK2CM681Q25KT
	820	22x45	0.15	2.55	ELK2CM821O45KT
		25x35	0.15	2.52	ELK2CM821P35KT
	1000	30x30	0.15	2.51	ELK2CM821Q30KT
		22x50	0.15	2.88	ELK2CM102O50KT
1200	25x40	0.15	2.86	ELK2CM102P40KT	
	30x30	0.15	2.82	ELK2CM102Q30KT	
1500	25x45	0.15	3.27	ELK2CM122P45KT	
	30x35	0.15	3.25	ELK2CM122Q35KT	
1800	35x30	0.15	3.24	ELK2CM122R30KT	
	30x40	0.15	3.77	ELK2CM152Q40KT	
2200	35x35	0.15	3.75	ELK2CM152R35KT	
	30x45	0.15	4.10	ELK2CM182Q45KT	
2700	35x35	0.15	4.08	ELK2CM182R35KT	
	35x45	0.15	4.72	ELK2CM222R45KT	
	35x50	0.15	5.30	ELK2CM272R50KT	
180(2L)	330	22x25	0.15	1.42	ELK2LM331O25KT
	390	22x30	0.15	1.61	ELK2LM391O30KT
	470	22x30	0.15	1.80	ELK2LM471O30KT
		25x25	0.15	1.80	ELK2LM471P25KT
	560	22x35	0.15	2.09	ELK2LM561O35KT
		25x30	0.15	2.05	ELK2LM561P30KT
	680	22x40	0.15	2.36	ELK2LM681O40KT
		25x35	0.15	2.34	ELK2LM681P35KT
	820	30x25	0.15	2.27	ELK2LM681Q25KT
		22x45	0.15	2.72	ELK2LM821O45KT
	1000	25x35	0.15	2.58	ELK2LM821P35KT
		30x30	0.15	2.56	ELK2LM821Q30KT
	1200	25x45	0.15	2.91	ELK2LM102P45KT
		30x35	0.15	2.95	ELK2LM102Q35KT
	1500	25x50	0.15	3.46	ELK2LM122P50KT
		30x40	0.15	3.38	ELK2LM122Q40KT
	1800	35x30	0.15	3.32	ELK2LM122R30KT
		30x45	0.15	3.90	ELK2LM152Q45KT
	2200	35x35	0.15	3.83	ELK2LM152R35KT
		30x50	0.15	4.33	ELK2LM182Q50KT
	2700	35x40	0.15	4.32	ELK2LM182R40KT
		35x45	0.15	4.60	ELK2LM222R45KT
		35x50	0.15	5.05	ELK2LM272R50KT
	200(2D)	270	22x25	0.15	1.30
330		22x25	0.15	1.44	ELK2DM331O25KT
390		22x30	0.15	1.65	ELK2DM391O30KT
		25x25	0.15	1.63	ELK2DM391P25KT
470		22x35	0.15	1.88	ELK2DM471O35KT
		25x35	0.15	1.86	ELK2DM471P35KT
560		22x40	0.15	2.08	ELK2DM561O40KT
		25x30	0.15	2.05	ELK2DM561P30KT
680		30x25	0.15	2.05	ELK2DM561Q25KT
		22x45	0.15	2.36	ELK2DM681O45KT
		25x35	0.15	2.36	ELK2DM681P35KT
		30x30	0.15	2.36	ELK2DM681Q30KT

LK series

■ STANDARD RATINGS

WV (Vdc)	Cap (µF)	Size DxL(mm)	tan	Rated ripple current (Arms/85°C, 120Hz)	Part Number
200(2D)	820	22x50	0.15	2.68	ELK2DM821O50KT
		25x40	0.15	2.66	ELK2DM821P40KT
		30x30	0.15	2.62	ELK2DM821Q30KT
	1000	25x45	0.15	3.12	ELK2DM102P45KT
		30x35	0.15	3.00	ELK2DM102Q35KT
		35x30	0.15	2.96	ELK2DM102R30KT
	1200	25x50	0.15	3.44	ELK2DM122P50KT
		30x40	0.15	3.44	ELK2DM122Q40KT
		35x35	0.15	3.40	ELK2DM122R35KT
	1500	30x50	0.15	3.93	ELK2DM152Q50KT
		35x40	0.15	3.87	ELK2DM152R40KT
	1800	35x45	0.15	4.37	ELK2DM182R45KT
2200	35x50	0.15	5.00	ELK2DM222R50KT	
220(2N)	220	22x25	0.15	1.18	ELK2NM221O25KT
	270	22x25	0.15	1.31	ELK2NM271O25KT
	330	22x30	0.15	1.58	ELK2NM331O30KT
		25x25	0.15	1.49	ELK2NM331P25KT
	390	22x35	0.15	1.69	ELK2NM391O35KT
		25x30	0.15	1.71	ELK2NM391P30KT
	470	22x40	0.15	1.99	ELK2NM471O40KT
		25x30	0.15	1.95	ELK2NM471P30KT
		30x25	0.15	1.89	ELK2NM471Q25KT
	560	22x45	0.15	2.28	ELK2NM561O45KT
		25x35	0.15	2.22	ELK2NM561P35KT
		30x30	0.15	2.19	ELK2NM561Q30KT
	680	22x50	0.15	2.46	ELK2NM681O50KT
		25x40	0.15	2.40	ELK2NM681P40KT
		30x30	0.15	2.39	ELK2NM681Q30KT
820	25x45	0.15	2.81	ELK2NM821P45KT	
	30x35	0.15	2.70	ELK2NM821Q35KT	
	35x30	0.15	2.62	ELK2NM821R30KT	
1000	25x50	0.15	3.13	ELK2NM102P50KT	
	30x40	0.15	3.08	ELK2NM102Q40KT	
	35x35	0.15	3.05	ELK2NM102R35KT	
1200	30x45	0.15	3.60	ELK2NM122Q45KT	
	35x40	0.15	3.51	ELK2NM122R40KT	
1500	35x45	0.15	3.92	ELK2NM152R45KT	
250(2E)	220	22x25	0.15	1.18	ELK2EM221O25KT
	270	22x30	0.15	1.43	ELK2EM271O30KT
	330	22x30	0.15	1.58	ELK2EM331O30KT
		25x25	0.15	1.53	ELK2EM331P25KT
	390	22x25	0.15	1.79	ELK2EM391O25KT
		25x30	0.15	1.79	ELK2EM391P30KT
	470	22x40	0.15	2.05	ELK2EM471O40KT
		25x35	0.15	2.05	ELK2EM471P35KT
		30x25	0.15	1.94	ELK2EM471Q25KT
	560	22x45	0.15	2.36	ELK2EM561O45KT
		25x35	0.15	2.24	ELK2EM561P35KT
		30x30	0.15	2.24	ELK2EM561Q30KT
	680	25x40	0.15	2.54	ELK2EM681P40KT
		30x35	0.15	2.58	ELK2EM681Q35KT
	820	25x50	0.15	2.87	ELK2EM821P50KT
		30x35	0.15	2.84	ELK2EM821Q35KT
		35x30	0.15	2.82	ELK2EM821R30KT
	1000	30x45	0.15	3.39	ELK2EM102Q45KT
35x35		0.15	3.31	ELK2EM102R35KT	
1200	30x50	0.15	3.80	ELK2EM122Q50KT	
	35x40	0.15	3.66	ELK2EM122R40KT	
1500	35x45	0.15	4.12	ELK2EM152R45KT	
1800	35x50	0.15	4.31	ELK2EM182R50KT	

WV (Vdc)	Cap (µF)	Size DxL(mm)	tan	Rated ripple current (Arms/85°C, 120Hz)	Part Number
315(2F)	180	22x30	0.15	1.23	ELK2FM181O30KT
		25x25	0.15	1.31	ELK2FM181P25KT
	220	22x35	0.15	1.34	ELK2FM221O35KT
		25x30	0.15	1.40	ELK2FM221P30KT
	270	22x40	0.15	1.60	ELK2FM271O40KT
		25x30	0.15	1.62	ELK2FM271P30KT
	330	22x45	0.15	1.82	ELK2FM331O45KT
		25x35	0.15	1.85	ELK2FM331P35KT
		30x30	0.15	1.89	ELK2FM331Q30KT
	390	22x50	0.15	1.97	ELK2FM391O50KT
		25x40	0.15	2.01	ELK2FM391P40KT
		30x30	0.15	2.05	ELK2FM391Q30KT
470	25x45	0.15	2.20	ELK2FM471P45KT	
	30x35	0.15	2.27	ELK2FM471Q35KT	
	35x30	0.15	2.25	ELK2FM471R30KT	
560	30x40	0.15	2.50	ELK2FM561Q40KT	
	35x35	0.15	2.56	ELK2FM561R35KT	
680	30x45	0.15	2.67	ELK2FM681Q45KT	
	35x40	0.15	2.90	ELK2FM681R40KT	
820	30x50	0.15	3.12	ELK2FM821Q50KT	
	35x45	0.15	3.29	ELK2FM821R45KT	
1000	35x50	0.15	3.40	ELK2FM102R50KT	
350(2V)	120	22x25	0.15	0.99	ELK2VM121O25KT
		22x30	0.15	1.44	ELK2VM151O30KT
	150	25x25	0.15	1.16	ELK2VM151P25KT
		22x35	0.15	1.28	ELK2VM181O35KT
	180	25x30	0.15	1.30	ELK2VM181P30KT
		22x40	0.15	1.40	ELK2VM221O40KT
	220	25x35	0.15	1.46	ELK2VM221P35KT
		30x25	0.15	1.47	ELK2VM221Q25KT
	270	22x45	0.15	1.62	ELK2VM271O45KT
		25x35	0.15	1.65	ELK2VM271P35KT
		30x30	0.15	1.71	ELK2VM271Q30KT
	330	22x50	0.15	1.78	ELK2VM331O50KT
25x40		0.15	1.88	ELK2VM331P40KT	
30x35		0.15	1.93	ELK2VM331Q35KT	
390	25x45	0.15	2.04	ELK2VM391P45KT	
	30x35	0.15	2.12	ELK2VM391Q35KT	
	35x30	0.15	2.19	ELK2VM391R30KT	
470	30x40	0.15	2.41	ELK2VM471Q40KT	
	35x35	0.15	2.43	ELK2VM471R35KT	
560	30x45	0.15	2.60	ELK2VM561Q45KT	
	35x35	0.15	2.62	ELK2VM561R35KT	
680	35x40	0.15	3.00	ELK2VM681R40KT	
	820	35x50	0.15	3.30	ELK2VM821R50KT
385(3B)	82	22x25	0.15	0.70	ELK3BM820O25KT
	100	22x30	0.15	0.82	ELK3BM101O30KT
	120	22x30	0.15	0.91	ELK3BM121O30KT
		25x25	0.15	0.95	ELK3BM121P25KT
	150	22x35	0.15	1.04	ELK3BM151O35KT
		25x30	0.15	1.08	ELK3BM151P30KT
	180	22x40	0.15	1.18	ELK3BM181O40KT
		25x35	0.15	1.20	ELK3BM181P35KT
		30x25	0.15	1.28	ELK3BM181Q25KT
	220	22x45	0.15	1.33	ELK3BM221O45KT
		25x35	0.15	1.44	ELK3BM221P35KT
	270	30x30	0.15	1.40	ELK3BM221Q30KT
25x40		0.15	1.56	ELK3BM271P40KT	
	30x35	0.15	1.62	ELK3BM271Q35KT	

Snap-in&Lug Terminal Type

LK series

■ STANDARD RATINGS

WV (Vdc)	Cap (μF)	Size DxL(mm)	tan	Rated ripple current (Arms/85°C, 120Hz)	Part Number
385(3B)	330	25x50	0.15	1.80	ELK3BM331P50KT
		30x40	0.15	1.85	ELK3BM331Q40KT
		35x30	0.15	1.85	ELK3BM331R30KT
	390	30x40	0.15	2.04	ELK3BM391Q40KT
		35x35	0.15	2.06	ELK3BM391R35KT
		30x50	0.15	2.27	ELK3BM471Q50KT
	470	35x40	0.15	2.30	ELK3BM471R40KT
		560	35x45	0.15	2.57
	680	35x50	0.15	2.80	ELK3BM681R50KT
400(2G)	82	22x25	0.15	0.80	ELK2GM820O25KT
	100	22x30	0.15	0.94	ELK2GM101O30KT
	120	22x30	0.15	1.04	ELK2GM121O30KT
		25x25	0.15	1.08	ELK2GM121P25KT
	150	22x35	0.15	1.18	ELK2GM151O35KT
		25x30	0.15	1.21	ELK2GM151P30KT
	180	22x40	0.15	1.34	ELK2GM181O40KT
		25x35	0.15	1.37	ELK2GM181P35KT
		30x25	0.15	1.45	ELK2GM181Q25KT
	220	22x50	0.15	1.50	ELK2GM221O50KT
		25x35	0.15	1.56	ELK2GM221P35KT
	270	30x30	0.15	1.58	ELK2GM221Q30KT
		25x40	0.15	1.70	ELK2GM271P40KT
	330	30x35	0.15	1.73	ELK2GM271Q35KT
		25x50	0.15	1.90	ELK2GM331P50KT
		30x40	0.15	1.95	ELK2GM331Q40KT
	390	35x30	0.15	1.95	ELK2GM331R30KT
		30x40	0.15	2.15	ELK2GM391Q40KT
		35x35	0.15	2.17	ELK2GM391R35KT
	470	30x50	0.15	2.39	ELK2GM471Q50KT
		35x40	0.15	2.42	ELK2GM471R40KT
	560	35x45	0.15	2.71	ELK2GM561R45KT
680	35x50	0.15	2.95	ELK2GM681R50KT	
820	35x60	0.15	3.25	ELK2GM821R60KT	
	40x50	0.15	3.20	ELK2GM821Y50PT	
1000	35x70	0.15	3.65	ELK2GM102R70KT	
	40x60	0.15	3.55	ELK2GM102Y60PT	
1200	35x80	0.15	4.20	ELK2GM122R80KT	
	40x70	0.15	4.20	ELK2GM122Y70PT	
1500	40x80	0.15	4.90	ELK2GM152Y80PT	
1800	40x90	0.15	5.75	ELK2GM182Y90PT	
2200	40x100	0.15	6.66	ELK2GM222YA0PT	
420(2T)	82	22x25	0.15	0.75	ELK2TM820O25KT
	100	22x30	0.15	0.87	ELK2TM101O30KT
		25x25	0.15	0.92	ELK2TM101P25KT
	120	22x30	0.15	1.01	ELK2TM121O30KT
		25x25	0.15	1.03	ELK2TM121P25KT
	150	22x35	0.15	1.19	ELK2TM151O35KT
		25x30	0.15	1.19	ELK2TM151P30KT
		30x25	0.15	1.14	ELK2TM151Q25KT
	180	22x45	0.15	1.36	ELK2TM181O45KT
		25x35	0.15	1.37	ELK2TM181P35KT
		30x25	0.15	1.35	ELK2TM181Q25KT
	220	22x50	0.15	1.69	ELK2TM221O50KT
		25x40	0.15	1.58	ELK2TM221P40KT
	270	30x30	0.15	1.56	ELK2TM221Q30KT
		25x45	0.15	1.83	ELK2TM271P45KT
		30x35	0.15	1.72	ELK2TM271Q35KT
	330	35x30	0.15	1.76	ELK2TM271R30KT
		25x50	0.15	2.18	ELK2TM331P50KT
		30x40	0.15	1.98	ELK2TM331Q40KT
		35x35	0.15	2.04	ELK2TM331R35KT

WV (Vdc)	Cap (μF)	Size DxL(mm)	tan	Rated ripple current (Arms/85°C, 120Hz)	Part Number
420(2T)	390	30x45	0.15	2.34	ELK2TM391Q45KT
		35x35	0.15	2.26	ELK2TM391R35KT
	470	30x50	0.15	2.67	ELK2TM471Q50KT
		35x40	0.15	2.60	ELK2TM471R40KT
	560	35x45	0.15	2.93	ELK2TM561R45KT
	680	35x50	0.15	3.25	ELK2TM681R50KT
	820	35x60	0.15	3.60	ELK2TM821R60KT
		40x50	0.15	3.59	ELK2TM821Y50PT
	1000	35x70	0.15	3.96	ELK2TM102R70KT
		40x60	0.15	3.80	ELK2TM102Y60PT
1200	35x80	0.15	4.60	ELK2TM122R80KT	
	40x70	0.15	4.49	ELK2TM122Y70PT	
1500	40x80	0.15	5.32	ELK2TM152Y80PT	
1800	40x100	0.15	5.95	ELK2TM182YA0PT	
2200	45x100	0.15	6.85	ELK2TM222IA0PT	
450(2W)	68	22x25	0.15	0.68	ELK2WM680O25KT
	82	22x30	0.15	0.82	ELK2WM820O30KT
	100	22x35	0.15	0.90	ELK2WM101O35KT
		25x25	0.15	0.92	ELK2WM101P25KT
	120	22x35	0.15	1.02	ELK2WM121O35KT
		25x30	0.15	1.04	ELK2WM121P30KT
	150	30x25	0.15	1.07	ELK2WM121Q25KT
		22x40	0.15	1.12	ELK2WM151O40KT
		25x35	0.15	1.19	ELK2WM151P35KT
	180	30x30	0.15	1.23	ELK2WM151Q30KT
		22x50	0.15	1.26	ELK2WM181O50KT
		25x40	0.15	1.33	ELK2WM181P40KT
	220	30x30	0.15	1.38	ELK2WM181Q30KT
		25x45	0.15	1.51	ELK2WM221P45KT
		30x35	0.15	1.56	ELK2WM221Q35KT
	270	35x30	0.15	1.58	ELK2WM221R30KT
		25x50	0.15	1.65	ELK2WM271P50KT
	330	30x40	0.15	1.80	ELK2WM271Q40KT
		35x35	0.15	1.81	ELK2WM271R35KT
	390	30x45	0.15	2.02	ELK2WM331Q45KT
		35x35	0.15	2.05	ELK2WM331R35KT
	470	30x50	0.15	2.24	ELK2WM391Q50KT
35x40		0.15	2.27	ELK2WM391R40KT	
560	35x45	0.15	2.55	ELK2WM471R45KT	
680	35x50	0.15	2.85	ELK2WM561R50KT	
820	35x60	0.15	3.15	ELK2WM681R50KT	
	40x55	0.15	3.60	ELK2WM821R60KT	
1000	40x55	0.15	3.69	ELK2WM821Y55PT	
	35x80	0.15	4.30	ELK2WM102R80KT	
1200	40x70	0.15	4.42	ELK2WM102Y70PT	
1500	40x85	0.15	4.80	ELK2WM122Y80PT	
1800	40x100	0.15	5.40	ELK2WM152Y85PT	
2200	45x100	0.15	5.90	ELK2WM182YA0PT	
			7.00	ELK2WM222IA0PT	

LK series

■ STANDARD RATINGS

WV (Vdc)	Cap (μF)	Size DxL(mm)	tan	Rated ripple current (Arms/85°C, 120Hz)	Part Number
500(2H)	56	22x25	0.15	0.63	ELK2HM560O25KT
	68	22x30	0.15	0.69	ELK2HM680O30KT
		25x25	0.15	0.68	ELK2HM680P25KT
	82	22x35	0.15	0.85	ELK2HM820O35KT
		25x30	0.15	0.88	ELK2HM820P30KT
	100	22x40	0.15	0.94	ELK2HM101O40KT
		25x35	0.15	0.96	ELK2HM101P35KT
	120	22x45	0.15	1.06	ELK2HM121O45KT
		25x40	0.15	1.09	ELK2HM121P40KT
		30x35	0.15	1.13	ELK2HM121Q35KT
	150	22x50	0.15	1.19	ELK2HM151O50KT
		25x45	0.15	1.23	ELK2HM151P45KT
		30x40	0.15	1.26	ELK2HM151Q40KT
	180	25x50	0.15	1.39	ELK2HM181P50KT
		30x45	0.15	1.43	ELK2HM181Q45KT
	220	30x50	0.15	1.60	ELK2HM221Q50KT
		35x35	0.15	1.62	ELK2HM221R35KT
	270	35x40	0.15	1.85	ELK2HM271R40KT
	330	35x50	0.15	2.08	ELK2HM331R50KT
	390	35x55	0.15	2.31	ELK2HM391R55KT
470	35x60	0.15	2.61	ELK2HM471R60KT	

LH series

- Withstand high temperature, for general purpose
- Endurance: 2,000 hours at 105°C
- RoHS Compliant

Upgrade



SPECIFICATIONS

Items	Characteristics											
Category Temperature Range	-40~+105°C						-25~+105°C					
Rated Voltage Range	10~100V.DC						160~500V.DC					
Capacitance Tolerance	±20% (M) (at 20°C, 120Hz)											
Leakage Current	$I \leq 3\sqrt{CV}$ Where, I: Max.leakage current (µA), C: Nominal capacitance (µF), V: Rated voltage (V) (at 20°C after 5 minutes)											
Dissipation Factor (tan δ)	Rated Voltage (V _{dc})	10	16	25	35	50	63	80	100	160 to 250	315 to 450	500
	tan δ (max.)	0.55	0.50	0.45	0.40	0.35	0.30	0.25	0.20	0.15	0.15	0.20
Low Temperature Characteristics (Max. Impedance Ratio)	Rated Voltage (V _{dc})	10	16	25	35	50	63	80	100	160 to 250	315 to 400	420 to 500
	Z(-25°C)/Z(+20°C)	4	4	3	3	2	2	2	2	4	8	8
	Z(-40°C)/Z(+20°C)	15	15	10	8	6	6	5	5	-	-	-
Endurance	The following specifications shall be satisfied when the capacitors are restored to 20°C after DC voltage plus the rated ripple current is applied for 2,000 hours at 105°C.											
	Capacitance Change	±20% of the initial value										
	D.F. (tan δ)	200% of the initial specified value										
	Leakage Current	The initial specified value										
Shelf Life	The following specifications shall be satisfied when the capacitors are restored to 20°C after exposing them for 1,000 hours at 105°C without voltage applied.											
	Capacitance Change	±20% of the initial value										
	D.F. (tan δ)	150% of the initial specified value										
	Leakage Current	200% of the initial specified value										

DIMENSIONS [mm]

- Terminal Code : K (22 to 35) : Standard

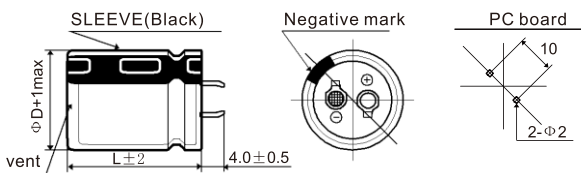

- Terminal Code: P (40 to 45)

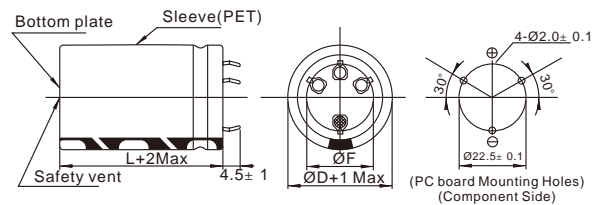

PART NUMBERING SYSTEM

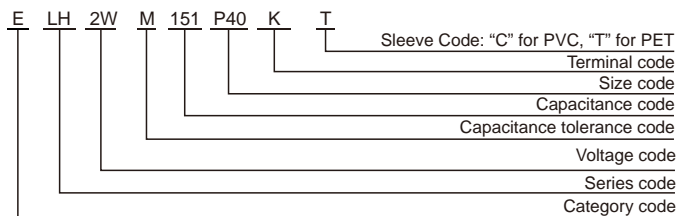

RATED RIPPLE CURRENT MULTIPLIERS

Frequency correction factor for ripple current

Rated voltage(V _{dc})	Freq.(Hz)			
	120	1k	10k	100k
10~50	1.00	1.03	1.05	1.08
63~100	1.00	1.07	1.13	1.19
160~250	1.00	1.32	1.45	1.50
315~500	1.00	1.30	1.41	1.43

The endurance of capacitors is shortened with internal heating produced by ripple current at the rate of halving the lifetime with every 5°C rise. When long life performance is required in actual use, the rms ripple current has to be reduced.

LH series

■ STANDARD RATINGS

WV (Vdc)	Cap (µF)	Size DxL(mm)	tan	Rated ripple current (Arms/105°C, 120Hz)	Part Number
10(1A)	10000	22x25	0.55	1.77	ELH1AM103O25KT
	12000	22x30	0.55	2.10	ELH1AM123O30KT
		25x25	0.55	1.94	ELH1AM123P25KT
		22x35	0.55	2.23	ELH1AM153O35KT
	15000	25x30	0.55	2.10	ELH1AM153P30KT
		22x40	0.55	2.41	ELH1AM183O40KT
	18000	25x30	0.55	2.34	ELH1AM183P30KT
		30x25	0.55	2.25	ELH1AM183Q25KT
		22x45	0.55	2.58	ELH1AM223O45KT
	22000	25x35	0.55	2.54	ELH1AM223P35KT
		30x30	0.55	2.50	ELH1AM223Q30KT
	27000	22x50	0.55	3.17	ELH1AM273O50KT
		25x40	0.55	3.07	ELH1AM273P40KT
		30x30	0.55	2.95	ELH1AM273Q30KT
	33000	25x45	0.55	3.39	ELH1AM333P45KT
		30x35	0.55	3.33	ELH1AM333Q35KT
		35x30	0.55	3.21	ELH1AM333R30KT
	39000	30x40	0.55	3.70	ELH1AM393Q40KT
		35x35	0.55	3.68	ELH1AM393R35KT
	47000	30x45	0.55	4.22	ELH1AM473Q45KT
35x40		0.55	4.16	ELH1AM473R40KT	
56000	35x45	0.55	5.00	ELH1AM563R45KT	
16(1C)	6800	22x25	0.50	1.75	ELH1CM682O25KT
	8200	22x30	0.50	2.00	ELH1CM822O30KT
	10000	22x30	0.50	2.10	ELH1CM103O30KT
		25x25	0.50	2.05	ELH1CM103P25KT
	12000	22x35	0.50	2.31	ELH1CM123O35KT
		25x30	0.50	2.30	ELH1CM123P30KT
		30x25	0.50	2.30	ELH1CM123Q25KT
	15000	22x40	0.50	2.68	ELH1CM153O40KT
		25x35	0.50	2.58	ELH1CM153P35KT
		30x30	0.50	2.57	ELH1CM153Q30KT
	18000	22x50	0.50	3.20	ELH1CM183O50KT
		25x40	0.50	3.16	ELH1CM183P40KT
		30x30	0.50	2.98	ELH1CM183Q30KT
		25x45	0.50	3.36	ELH1CM223P45KT
	22000	30x35	0.50	3.30	ELH1CM223Q35KT
		35x30	0.50	3.25	ELH1CM223R30KT
		25x50	0.50	3.85	ELH1CM273P50KT
	27000	30x40	0.50	3.80	ELH1CM273Q40KT
		35x35	0.50	3.93	ELH1CM273R35KT
	33000	30x45	0.50	4.30	ELH1CM333Q45KT
35x35		0.50	4.27	ELH1CM333R35KT	
39000	30x50	0.50	4.81	ELH1CM393Q50KT	
	35x40	0.50	4.80	ELH1CM393R40KT	
47000	35x45	0.50	5.53	ELH1CM473R45KT	
25(1E)	4700	22x25	0.45	1.61	ELH1EM472O25KT
	5600	22x30	0.45	1.80	ELH1EM562O30KT
	6800	22x35	0.45	2.09	ELH1EM682O35KT
		25x25	0.45	1.87	ELH1EM682P25KT
	8200	22x40	0.45	2.31	ELH1EM822O40KT
		25x30	0.45	2.34	ELH1EM822P30KT
		30x25	0.45	2.16	ELH1EM822Q25KT
	10000	22x45	0.45	2.65	ELH1EM103O45KT
		25x35	0.45	2.61	ELH1EM103P35KT
		30x30	0.45	2.61	ELH1EM103Q30KT
	12000	22x50	0.45	2.80	ELH1EM123O50KT
		25x40	0.45	2.81	ELH1EM123P40KT
30x30		0.45	2.74	ELH1EM123Q30KT	

WV (Vdc)	Cap (µF)	Size DxL(mm)	tan	Rated ripple current (Arms/105°C, 120Hz)	Part Number	
25(1E)	15000	25x45	0.45	3.27	ELH1EM153P45KT	
		30x35	0.45	3.13	ELH1EM153Q35KT	
		35x30	0.45	3.26	ELH1EM153R30KT	
		30x40	0.45	3.56	ELH1EM183Q40KT	
	18000	35x35	0.45	3.84	ELH1EM183R35KT	
		30x45	0.45	4.04	ELH1EM223Q45KT	
		35x35	0.45	3.75	ELH1EM223R35KT	
	22000	27000	35x45	0.45	4.74	ELH1EM273R45KT
		33000	35x50	0.45	5.50	ELH1EM333R50KT
	35(1V)	3300	22x25	0.40	1.45	ELH1VM332O25KT
3900		22x30	0.40	1.69	ELH1VM392O30KT	
		22x35	0.40	2.02	ELH1VM472O35KT	
4700		25x25	0.40	1.62	ELH1VM472P25KT	
		22x35	0.40	2.13	ELH1VM562O35KT	
5600		25x30	0.40	2.00	ELH1VM562P30KT	
		22x40	0.40	2.41	ELH1VM682O40KT	
6800		25x35	0.40	2.31	ELH1VM682P35KT	
		30x25	0.40	2.31	ELH1VM682Q25KT	
		22x50	0.40	2.85	ELH1VM822O50KT	
8200		25x40	0.40	2.73	ELH1VM822P40KT	
		30x30	0.40	2.75	ELH1VM822Q30KT	
		25x45	0.40	3.05	ELH1VM103P45KT	
		30x35	0.40	3.05	ELH1VM103Q35KT	
10000		25x50	0.40	3.37	ELH1VM123P50KT	
		12000	30x40	0.40	3.23	ELH1VM123Q40KT
			35x30	0.40	3.19	ELH1VM123R30KT
		15000	30x45	0.40	3.72	ELH1VM153Q45KT
35x35	0.40		3.67	ELH1VM153R35KT		
18000	35x40		0.40	4.37	ELH1VM183R40KT	
22000	35x45		0.40	4.92	ELH1VM223R45KT	
50(1H)	1800	22x25	0.35	1.34	ELH1HM182O25KT	
	2200	22x30	0.35	1.60	ELH1HM222O30KT	
	2700	22x30	0.35	1.70	ELH1HM272O30KT	
		25x25	0.35	1.70	ELH1HM272P25KT	
	3300	22x35	0.35	1.97	ELH1HM332O35KT	
		25x30	0.35	1.88	ELH1HM332P30KT	
		22x40	0.35	2.22	ELH1HM392O40KT	
	3900	25x30	0.35	2.20	ELH1HM392P30KT	
		30x25	0.35	1.95	ELH1HM392Q25KT	
		22x45	0.35	2.43	ELH1HM472O45KT	
	4700	25x35	0.35	2.43	ELH1HM472P35KT	
		30x30	0.35	2.25	ELH1HM472Q30KT	
		22x50	0.35	2.75	ELH1HM562O50KT	
	5600	25x40	0.35	2.72	ELH1HM562P40KT	
		30x30	0.35	2.64	ELH1HM562Q30KT	
		25x45	0.35	3.30	ELH1HM682P45KT	
	6800	30x35	0.35	3.30	ELH1HM682Q35KT	
		35x30	0.35	3.25	ELH1HM682R30KT	
30x40		0.35	3.60	ELH1HM822Q40KT		
8200	35x35	0.35	3.60	ELH1HM822R35KT		
	30x50	0.35	4.05	ELH1HM103Q50KT		
	35x40	0.35	4.04	ELH1HM103R40KT		
10000	12000	35x45	0.35	4.56	ELH1HM123R45KT	
	15000	35x50	0.35	4.77	ELH1HM153R50KT	
	63(1J)	1200	22x25	0.30	1.20	ELH1JM122O25KT
1500		22x30	0.30	1.47	ELH1JM152O30KT	
		22x30	0.30	1.58	ELH1JM182O30KT	
1800		25x25	0.30	1.52	ELH1JM182P25KT	
		22x35	0.30	1.82	ELH1JM222O35KT	
2200	25x30	0.30	1.75	ELH1JM222P30KT		

Snap-in&Lug Terminal Type

LH series

■ STANDARD RATINGS

WV (Vdc)	Cap (μF)	Size DxL(mm)	tan	Rated ripple current (Arms/105°C, 120Hz)	Part Number
63(1J)	2700	22x40	0.30	2.07	ELH1JM272O40KT
		25x35	0.30	2.11	ELH1JM272P35KT
		30x25	0.30	1.72	ELH1JM272Q25KT
	3300	22x45	0.30	2.33	ELH1JM332O45KT
		25x35	0.30	2.27	ELH1JM332P35KT
		30x30	0.30	2.24	ELH1JM332Q30KT
	3900	25x40	0.30	2.51	ELH1JM392P40KT
		30x35	0.30	2.55	ELH1JM392Q35KT
	4700	25x50	0.30	2.97	ELH1JM472P50KT
		30x40	0.30	2.86	ELH1JM472Q40KT
		35x30	0.30	2.80	ELH1JM472R30KT
	5600	30x40	0.30	3.22	ELH1JM562Q40KT
		35x35	0.30	3.20	ELH1JM562R35KT
	6800	30x50	0.30	3.65	ELH1JM682Q50KT
		35x40	0.30	3.65	ELH1JM682R40KT
	8200	35x45	0.30	4.04	ELH1JM822R45KT
10000	35x50	0.30	4.48	ELH1JM103R50KT	
80(1B)	1000	22x25	0.25	1.19	ELH1BM102O25KT
	1200	22x30	0.25	1.44	ELH1BM122O30KT
	1500	22x30	0.25	1.59	ELH1BM152O30KT
		25x25	0.25	1.59	ELH1BM152P25KT
	1800	22x35	0.25	1.79	ELH1BM182O35KT
		25x30	0.25	1.71	ELH1BM182P30KT
	2200	22x40	0.25	2.03	ELH1BM222O40KT
		25x35	0.25	1.98	ELH1BM222P35KT
		30x25	0.25	1.98	ELH1BM222Q25KT
	2700	22x45	0.25	2.39	ELH1BM272O45KT
		25x40	0.25	2.35	ELH1BM272P40KT
		30x30	0.25	2.35	ELH1BM272Q30KT
	3300	25x45	0.25	2.64	ELH1BM332P45KT
		30x35	0.25	2.61	ELH1BM332Q35KT
		35x30	0.25	2.74	ELH1BM332R30KT
	3900	25x50	0.25	2.92	ELH1BM392P50KT
		30x40	0.25	2.82	ELH1BM392Q40KT
		35x30	0.25	2.97	ELH1BM392R30KT
	4700	30x45	0.25	3.34	ELH1BM472Q45KT
		35x35	0.25	3.38	ELH1BM472R35KT
5600	30x50	0.25	3.80	ELH1BM562Q50KT	
	35x40	0.25	3.80	ELH1BM562R40KT	
6800	35x45	0.25	3.90	ELH1BM682R45KT	
8200	35x50	0.25	4.20	ELH1BM822R50KT	
100(1K)	680	22x25	0.20	1.09	ELH1KM681O25KT
	820	22x30	0.20	1.32	ELH1KM821O30KT
	1000	22x30	0.20	1.47	ELH1KM102O30KT
		25x25	0.20	1.45	ELH1KM102P25KT
	1200	22x35	0.20	1.69	ELH1KM122O35KT
		25x30	0.20	1.68	ELH1KM122P30KT
	1500	22x40	0.20	1.97	ELH1KM152O40KT
		25x35	0.20	1.98	ELH1KM152P35KT
		30x25	0.20	1.95	ELH1KM152Q25KT
	1800	22x45	0.20	2.23	ELH1KM182O45KT
		25x40	0.20	2.20	ELH1KM182P40KT
		30x30	0.20	2.20	ELH1KM182Q30KT
	2200	25x45	0.20	2.53	ELH1KM222P45KT
		30x35	0.20	2.55	ELH1KM222Q35KT
		35x30	0.20	2.50	ELH1KM222R30KT
	2700	25x50	0.20	2.82	ELH1KM272P50KT
		30x40	0.20	2.86	ELH1KM272Q40KT
		35x35	0.20	2.89	ELH1KM272R35KT
	3300	30x45	0.20	3.30	ELH1KM332Q45KT
		35x35	0.20	3.25	ELH1KM332R35KT

WV (Vdc)	Cap (μF)	Size DxL(mm)	tan	Rated ripple current (Arms/105°C, 120Hz)	Part Number	
100(1K)	3900	30x50	0.20	3.60	ELH1KM392Q50KT	
		35x40	0.20	3.67	ELH1KM392R40KT	
	4700	35x45	0.20	3.80	ELH1KM472R45KT	
		35x50	0.20	4.05	ELH1KM562R50KT	
160(2C)	220	22x25	0.15	0.92	ELH2CM221O25KT	
		330	22x25	0.15	1.03	ELH2CM331O25KT
		390	22x30	0.15	1.17	ELH2CM391O30KT
	470	22x30	0.15	1.28	ELH2CM471O30KT	
		25x25	0.15	1.29	ELH2CM471P25KT	
	560	22x35	0.15	1.45	ELH2CM561O35KT	
		25x30	0.15	1.49	ELH2CM561P30KT	
	680	22x40	0.15	1.64	ELH2CM681O40KT	
		25x35	0.15	1.70	ELH2CM681P35KT	
		30x25	0.15	1.63	ELH2CM681Q25KT	
	820	22x45	0.15	1.85	ELH2CM821O45KT	
			0.15	1.92	ELH2CM821P40KT	
30x30		0.15	1.91	ELH2CM821Q30KT		
		25x45	0.15	2.17	ELH2CM102P45KT	
1000	30x35	0.15	2.19	ELH2CM102Q35KT		
	25x50	0.15	2.43	ELH2CM122P50KT		
1200	30x40	0.15	2.48	ELH2CM122Q40KT		
	35x30	0.15	2.25	ELH2CM122R30KT		
1500	30x45	0.15	2.82	ELH2CM152Q45KT		
	35x35	0.15	2.62	ELH2CM152R35KT		
1800	30x50	0.15	3.13	ELH2CM182Q50KT		
	35x40	0.15	2.97	ELH2CM182R40KT		
2200	35x45	0.15	3.34	ELH2CM222R45KT		
180(2L)	270	22x25	0.15	0.97	ELH2LM271O25KT	
	330	22x30	0.15	1.13	ELH2LM331O30KT	
	390	22x30	0.15	1.32	ELH2LM391O30KT	
		25x25	0.15	1.33	ELH2LM391P25KT	
	470	22x35	0.15	1.39	ELH2LM471O35KT	
		25x30	0.15	1.43	ELH2LM471P30KT	
	560	22x40	0.15	1.56	ELH2LM561O40KT	
		25x30	0.15	1.53	ELH2LM561P30KT	
		30x25	0.15	1.56	ELH2LM561Q25KT	
	680	22x45	0.15	1.76	ELH2LM681O45KT	
		25x35	0.15	1.76	ELH2LM681P35KT	
		30x30	0.15	1.74	ELH2LM681Q30KT	
	820	22x50	0.15	1.97	ELH2LM821O50KT	
		25x40	0.15	1.99	ELH2LM821P40KT	
		30x30	0.15	1.93	ELH2LM821Q30KT	
		25x45	0.15	2.24	ELH2LM102P45KT	
	1000	30x35	0.15	2.24	ELH2LM102Q35KT	
		35x30	0.15	2.20	ELH2LM102R30KT	
		30x40	0.15	2.53	ELH2LM122Q40KT	
	1200	35x35	0.15	2.54	ELH2LM122R35KT	
30x50		0.15	3.03	ELH2LM152Q50KT		
1500	35x40	0.15	2.91	ELH2LM152R40KT		
	35x45	0.15	3.25	ELH2LM182R45KT		
2200	35x50	0.15	3.62	ELH2LM222R50KT		
200(2D)	270	22x25	0.15	0.99	ELH2DM271O25KT	
		22x30	0.15	1.20	ELH2DM331O30KT	
	330	25x25	0.15	1.20	ELH2DM331P25KT	
		22x35	0.15	1.30	ELH2DM391O35KT	
	390	25x30	0.15	1.34	ELH2DM391P30KT	
		22x40	0.15	1.44	ELH2DM471O40KT	
	470	25x30	0.15	1.44	ELH2DM471P30KT	
		30x25	0.15	1.48	ELH2DM471Q25KT	

LH series

■ STANDARD RATINGS

WV (Vdc)	Cap (μF)	Size DxL(mm)	tan	Rated ripple current (Arms/105°C, 120Hz)	Part Number	
200(2D)	560	22x45	0.15	1.60	ELH2DM561O45KT	
		25x35	0.15	1.60	ELH2DM561P35KT	
		30x30	0.15	1.60	ELH2DM561Q30KT	
	680	22x50	0.15	1.75	ELH2DM681O50KT	
		25x40	0.15	1.76	ELH2DM681P40KT	
		30x30	0.15	1.74	ELH2DM681Q30KT	
	820	25x45	0.15	2.10	ELH2DM821P45KT	
		30x35	0.15	2.11	ELH2DM821Q35KT	
		35x30	0.15	2.10	ELH2DM821R30KT	
	1000	25x50	0.15	2.36	ELH2DM102P50KT	
		30x40	0.15	2.40	ELH2DM102Q40KT	
		35x35	0.15	2.30	ELH2DM102R35KT	
	1200	30x45	0.15	2.69	ELH2DM122Q45KT	
		35x35	0.15	2.53	ELH2DM122R35KT	
	1500	35x40	0.15	2.97	ELH2DM152R40KT	
	1800	35x50	0.15	3.45	ELH2DM182R50KT	
	220(2N)	220	22x25	0.15	0.94	ELH2NM221O25KT
		270	22x30	0.15	1.09	ELH2NM271O30KT
330		22x35	0.15	1.24	ELH2NM331O35KT	
		25x25	0.15	1.14	ELH2NM331P25KT	
390		22x35	0.15	1.30	ELH2NM391O35KT	
		25x25	0.15	1.26	ELH2NM391P25KT	
470		22x40	0.15	1.41	ELH2NM471O40KT	
		25x30	0.15	1.39	ELH2NM471P30KT	
560		30x25	0.15	1.37	ELH2NM471Q25KT	
		22x45	0.15	1.60	ELH2NM561O45KT	
		25x35	0.15	1.56	ELH2NM561P35KT	
680		30x30	0.15	1.61	ELH2NM561Q30KT	
		35x25	0.15	1.52	ELH2NM561R25KT	
		25x40	0.15	1.75	ELH2NM681P40KT	
820		30x35	0.15	1.76	ELH2NM681Q35KT	
		35x30	0.15	1.72	ELH2NM681R30KT	
		25x45	0.15	1.97	ELH2NM821P45KT	
1000		30x40	0.15	2.06	ELH2NM821Q40KT	
		35x30	0.15	1.95	ELH2NM821R30KT	
		30x45	0.15	2.44	ELH2NM102Q45KT	
1200		35x35	0.15	2.20	ELH2NM102R35KT	
		35x40	0.15	2.37	ELH2NM122R40KT	
1500		30x45	0.15	2.64	ELH2NM152Q45KT	
250(2E)		180	22x25	0.15	0.84	ELH2EM181O25KT
	22x30		0.15	0.97	ELH2EM221O30KT	
	220	25x25	0.15	0.99	ELH2EM221P25KT	
		22x35	0.15	1.11	ELH2EM271O35KT	
	270	25x30	0.15	1.15	ELH2EM271P30KT	
		22x40	0.15	1.26	ELH2EM331O40KT	
	330	25x30	0.15	1.26	ELH2EM331P30KT	
		30x25	0.15	1.31	ELH2EM331Q25KT	
	390	22x45	0.15	1.41	ELH2EM391O45KT	
		25x35	0.15	1.42	ELH2EM391P35KT	
	470	30x30	0.15	1.50	ELH2EM391Q30KT	
		22x50	0.15	1.58	ELH2EM471O50KT	
	560	25x40	0.15	1.61	ELH2EM471P40KT	
		30x30	0.15	1.61	ELH2EM471Q30KT	
		25x45	0.15	1.80	ELH2EM561P45KT	
	680	30x35	0.15	1.84	ELH2EM561Q35KT	
		25x50	0.15	2.03	ELH2EM681P50KT	
		30x40	0.15	2.09	ELH2EM681Q40KT	
	820	35x30	0.15	1.96	ELH2EM681R30KT	
		30x45	0.15	2.35	ELH2EM821Q45KT	
			35x35	0.15	2.26	ELH2EM821R35KT

WV (Vdc)	Cap (μF)	Size DxL(mm)	tan	Rated ripple current (Arms/105°C, 120Hz)	Part Number
250(2E)	1000	30x50	0.15	2.64	ELH2EM102Q50KT
		35x40	0.15	2.57	ELH2EM102R40KT
	1200	35x45	0.15	2.88	ELH2EM122R45KT
		120	22x25	0.15	0.56
150	22x30	0.15	0.66	ELH2FM151O30KT	
	25x25	0.15	0.65	ELH2FM151P25KT	
180	22x35	0.15	0.78	ELH2FM181O35KT	
	25x30	0.15	0.71	ELH2FM181P30KT	
220	22x40	0.15	0.89	ELH2FM221O40KT	
	25x30	0.15	0.85	ELH2FM221P30KT	
270	30x25	0.15	0.83	ELH2FM221Q25KT	
	22x45	0.15	1.01	ELH2FM271O45KT	
315(2F)	270	25x35	0.15	0.98	ELH2FM271P35KT
		30x30	0.15	1.01	ELH2FM271Q30KT
330	330	22x50	0.15	1.14	ELH2FM331O50KT
		25x40	0.15	1.12	ELH2FM331P40KT
390	390	30x35	0.15	1.21	ELH2FM331Q35KT
		25x45	0.15	1.31	ELH2FM391P45KT
470	470	30x35	0.15	1.30	ELH2FM391Q35KT
		35x30	0.15	1.23	ELH2FM391R30KT
560	560	30x40	0.15	1.53	ELH2FM471Q40KT
		35x35	0.15	1.47	ELH2FM471R35KT
680	680	30x45	0.15	1.65	ELH2FM561Q45KT
		35x40	0.15	1.66	ELH2FM561R40KT
820	820	35x45	0.15	1.96	ELH2FM681R45KT
		35x50	0.15	2.19	ELH2FM821R50KT
350(2V)	100	22x25	0.15	0.53	ELH2VM101O25KT
		22x30	0.15	0.61	ELH2VM121O30KT
	120	25x25	0.15	0.62	ELH2VM121P25KT
		22x35	0.15	0.73	ELH2VM151O35KT
	150	25x30	0.15	0.73	ELH2VM151P30KT
		22x40	0.15	0.83	ELH2VM181O40KT
	180	25x30	0.15	0.80	ELH2VM181P30KT
		30x25	0.15	0.81	ELH2VM181Q25KT
	220	22x45	0.15	0.94	ELH2VM221O45KT
		25x35	0.15	0.92	ELH2VM221P35KT
	270	30x30	0.15	0.98	ELH2VM221Q30KT
		22x50	0.15	1.07	ELH2VM271O50KT
	330	25x40	0.15	1.05	ELH2VM271P40KT
		30x30	0.15	1.03	ELH2VM271Q30KT
	390	25x45	0.15	1.24	ELH2VM331P45KT
		30x35	0.15	1.24	ELH2VM331Q35KT
	470	35x30	0.15	1.18	ELH2VM331R30KT
		25x50	0.15	1.38	ELH2VM391P50KT
	560	30x40	0.15	1.39	ELH2VM391Q40KT
		35x35	0.15	1.39	ELH2VM391R35KT
	680	30x45	0.15	1.57	ELH2VM471Q45KT
		35x35	0.15	1.50	ELH2VM471R35KT
	820	30x50	0.15	1.75	ELH2VM561Q50KT
		35x40	0.15	1.69	ELH2VM561R40KT
385(3B)	100	22x25	0.15	0.45	ELH3BM680O25KT
		22x30	0.15	0.52	ELH3BM820Q30KT
120	22x30	0.15	0.58	ELH3BM101O30KT	
	25x25	0.15	0.57	ELH3BM101P25KT	
150	22x35	0.15	0.68	ELH3BM121O35KT	
	25x30	0.15	0.68	ELH3BM121P30KT	
200	22x40	0.15	0.79	ELH3BM151O40KT	
	25x30	0.15	0.78	ELH3BM151P30KT	
250	30x25	0.15	0.75	ELH3BM151Q25KT	

Snap-in&Lug Terminal Type

LH series

■ STANDARD RATINGS

WV (Vdc)	Cap (μF)	Size DxDL(mm)	tan	Rated ripple current (Arms/105°C, 120Hz)	Part Number
385(3B)	180	22x45	0.15	0.89	ELH3BM181O45KT
		25x35	0.15	0.86	ELH3BM181P35KT
		30x30	0.15	0.88	ELH3BM181Q30KT
	220	22x50	0.15	1.01	ELH3BM221O50KT
		25x40	0.15	1.00	ELH3BM221P40KT
		30x30	0.15	1.00	ELH3BM221Q30KT
	270	25x45	0.15	1.13	ELH3BM271P45KT
		30x40	0.15	1.14	ELH3BM271Q40KT
		35x30	0.15	1.10	ELH3BM271R30KT
	330	30x45	0.15	1.31	ELH3BM331Q45KT
		35x35	0.15	1.32	ELH3BM331R35KT
	390	30x50	0.15	1.48	ELH3BM391Q50KT
		35x40	0.15	1.48	ELH3BM391R40KT
	470	35x45	0.15	1.76	ELH3BM471R45KT
	560	35x50	0.15	1.95	ELH3BM561R50KT
400(2G)	68	22x25	0.15	0.49	ELH2GM680O25KT
	82	22x30	0.15	0.56	ELH2GM820O30KT
	100	22x30	0.15	0.62	ELH2GM101O30KT
		25x25	0.15	0.61	ELH2GM101P25KT
	120	22x35	0.15	0.73	ELH2GM121O35KT
		25x30	0.15	0.73	ELH2GM121P30KT
	150	22x40	0.15	0.85	ELH2GM151O40KT
		25x35	0.15	0.85	ELH2GM151P35KT
	180	30x25	0.15	0.79	ELH2GM151Q25KT
		22x45	0.15	0.95	ELH2GM181O45KT
	220	25x35	0.15	0.92	ELH2GM181P35KT
		30x30	0.15	0.95	ELH2GM181Q30KT
		22x50	0.15	1.08	ELH2GM221O50KT
	270	25x40	0.15	1.05	ELH2GM221P40KT
		30x35	0.15	1.24	ELH2GM221Q35KT
		25x50	0.15	1.29	ELH2GM271P50KT
	330	30x40	0.15	1.30	ELH2GM271Q40KT
		35x30	0.15	1.18	ELH2GM271R30KT
	390	30x45	0.15	1.47	ELH2GM331Q45KT
		35x35	0.15	1.40	ELH2GM331R35KT
	470	30x50	0.15	1.64	ELH2GM391Q50KT
		35x40	0.15	1.59	ELH2GM391R40KT
	560	35x45	0.15	1.68	ELH2GM471R45KT
	680	35x50	0.15	1.90	ELH2GM561R50KT
	820	35x50	0.15	2.03	ELH2GM681R50KT
	1000	35x60	0.15	2.36	ELH2GM821R60KT
		35x70	0.15	2.65	ELH2GM102R70KT
	1200	40x60	0.15	2.60	ELH2GM102Y60PT
1500	40x70	0.15	2.97	ELH2GM122Y70PT	
1800	40x80	0.15	3.48	ELH2GM152Y80PT	
1800	40x100	0.15	4.31	ELH2GM182YA0PT	
420(2T)	68	22x25	0.15	0.50	ELH2TM680O25KT
	82	22x30	0.15	0.56	ELH2TM820O30KT
		25x25	0.15	0.56	ELH2TM820P25KT
	100	22x30	0.15	0.63	ELH2TM101O30KT
		25x25	0.15	0.63	ELH2TM101P25KT
	120	22x35	0.15	0.73	ELH2TM121O35KT
		25x30	0.15	0.72	ELH2TM121P30KT
		30x25	0.15	0.75	ELH2TM121Q25KT
	150	22x45	0.15	0.86	ELH2TM151O45KT
		25x35	0.15	0.83	ELH2TM151P35KT
		30x25	0.15	0.83	ELH2TM151Q25KT
	180	22x50	0.15	1.02	ELH2TM181O50KT
		25x40	0.15	0.94	ELH2TM181P40KT
		30x30	0.15	0.95	ELH2TM181Q30KT
	35x25	0.15	0.90	ELH2TM181R25KT	

WV (Vdc)	Cap (μF)	Size DxDL(mm)	tan	Rated ripple current (Arms/105°C, 120Hz)	Part Number	
420(2T)	220	25x45	0.15	1.13	ELH2TM221P45KT	
		30x35	0.15	1.09	ELH2TM221Q35KT	
		35x30	0.15	1.05	ELH2TM221R30KT	
	270	25x50	0.15	1.37	ELH2TM271P50KT	
		30x40	0.15	1.25	ELH2TM271Q40KT	
		35x35	0.15	1.25	ELH2TM271R35KT	
	330	30x45	0.15	1.49	ELH2TM331Q45KT	
		35x35	0.15	1.42	ELH2TM331R35KT	
	390	30x50	0.15	1.67	ELH2TM391Q50KT	
		35x40	0.15	1.61	ELH2TM391R40KT	
		470	35x45	0.15	1.86	ELH2TM471R45KT
	1000	560	35x50	0.15	2.02	ELH2TM561R50KT
		680	35x50	0.15	2.20	ELH2TM681R50KT
		820	35x60	0.15	2.45	ELH2TM821R60KT
		35x70	0.15	2.82	ELH2TM102R70KT	
40x60		0.15	2.80	ELH2TM102Y60PT		
1200		40x70	0.15	3.20	ELH2TM122Y70PT	
1500		40x85	0.15	3.56	ELH2TM152Y85PT	
1800	40x100	0.15	4.31	ELH2TM182YA0PT		
450(2W)	56	22x25	0.15	0.42	ELH2WM560O25KT	
	68	22x30	0.15	0.50	ELH2WM680O30KT	
		25x25	0.15	0.50	ELH2WM680P25KT	
	82	22x35	0.15	0.56	ELH2WM820O35KT	
		25x30	0.15	0.57	ELH2WM820P30KT	
	100	22x40	0.15	0.64	ELH2WM101O40KT	
		25x30	0.15	0.63	ELH2WM101P30KT	
		30x25	0.15	0.67	ELH2WM101Q25KT	
	120	22x45	0.15	0.72	ELH2WM121O45KT	
		25x35	0.15	0.71	ELH2WM121P35KT	
		30x30	0.15	0.77	ELH2WM121Q30KT	
	150	22x50	0.15	0.80	ELH2WM151O50KT	
		25x40	0.15	0.82	ELH2WM151P40KT	
		30x30	0.15	0.85	ELH2WM151Q30KT	
	180	25x45	0.15	0.93	ELH2WM181P45KT	
		30x35	0.15	0.97	ELH2WM181Q35KT	
	220	25x50	0.15	1.05	ELH2WM221P50KT	
		30x40	0.15	1.10	ELH2WM221Q40KT	
		35x30	0.15	1.01	ELH2WM221R30KT	
	270	30x45	0.15	1.25	ELH2WM271Q45KT	
		35x35	0.15	1.26	ELH2WM271R35KT	
330	30x50	0.15	1.42	ELH2WM331Q50KT		
	35x40	0.15	1.44	ELH2WM331R40KT		
390	35x45	0.15	1.61	ELH2WM391R45KT		
470	35x50	0.15	1.80	ELH2WM471R50KT		
560	35x50	0.15	1.90	ELH2WM561R50KT		
680	35x55	0.15	2.12	ELH2WM681R55KT		
820	35x65	0.15	2.55	ELH2WM821R65KT		
1000	35x80	0.15	2.85	ELH2WM102R80KT		
	40x70	0.15	2.82	ELH2WM102Y70PT		
1200	40x80	0.15	3.22	ELH2WM122Y80PT		
1500	40x100	0.15	3.63	ELH2WM152YA0PT		
1800	45x100	0.15	4.35	ELH2WM182IA0PT		
500(2H)	47	22x25	0.20	0.41	ELH2HM470O25KT	
	56	22x30	0.20	0.43	ELH2HM560O30KT	
		22x30	0.20	0.52	ELH2HM680O30KT	
	68	25x25	0.20	0.55	ELH2HM680P25KT	
		22x35	0.20	0.62	ELH2HM820O35KT	
	82	25x30	0.20	0.57	ELH2HM820P30KT	
		22x45	0.20	0.68	ELH2HM101O45KT	
	100	25x30	0.20	0.72	ELH2HM101P30KT	

LH series

■ STANDARD RATINGS

WV (V _{dc})	Cap (μF)	Size DxL(mm)	tan	Rated ripple current (Arms/105°C, 120Hz)	Part Number
500(2H)	120	22x50	0.20	0.76	ELH2HM121O50KT
		25x35	0.20	0.79	ELH2HM121P35KT
		30x30	0.20	0.91	ELH2HM121Q30KT
	150	25x45	0.20	1.08	ELH2HM151P45KT
		30x35	0.20	1.04	ELH2HM151Q35KT
		35x25	0.20	0.99	ELH2HM151R25KT
	180	25x50	0.20	1.20	ELH2HM181P50KT
		30x40	0.20	1.17	ELH2HM181Q40KT
		35x30	0.20	1.10	ELH2HM181R30KT
	220	30x45	0.20	1.33	ELH2HM221Q45KT
		35x35	0.20	1.23	ELH2HM221R35KT
	270	30x50	0.20	1.50	ELH2HM271Q50KT
		35x40	0.20	1.42	ELH2HM271R40KT
	330	35x45	0.20	1.60	ELH2HM331R45KT
	390	35x50	0.20	1.78	ELH2HM391R50KT
	470	35x60	0.20	2.03	ELH2HM471R60KT

Snap-in&Lug Terminal Type

LC series

- Wide temperature range
- Miniaturized
- Endurance: 2,000 hours at 105°C
- Suitable for charging pile
- **RoHS Compliant**



SPECIFICATIONS

Items	Characteristics		
Category Temperature Range	-40~+105°C		
Rated Voltage Range	400~500V.DC		
Capacitance Tolerance	±20%(M) (at 20°C,120Hz)		
Leakage Current	$I \leq 3\sqrt{CV}$ Where, I:Max.leakage current (µA),C:Nominal capacitance (µF),V: Rated voltage (V) (at 20°C after 5 minutes)		
Dissipation Factor (tan δ)	Rated Voltage(V _{dc})	400	450,500
	tan (max.)	0.15	0.20
Low Temperature Characteristics (Max. Impedance Ratio)	Rated Voltage(V _{dc})	400~500	
	Z(-25°C)/Z(+20°C)	6	
	Z(-40°C)/Z(+20°C)	8	
Endurance	The following specifications shall be satisfied when the capacitors are restored to 20°C after DC voltage plus the rated ripple current is applied for 2,000 hours at 105 °C.		
	Capacitance Change	±20% of the initial value	
	D.F. (tan δ)	200% of the initial specified value	
	Leakage Current	The initial specified value	
Shelf Life	The following specifications shall be satisfied when the capacitors are restored to 20°C after exposing them for 1,000 hours at 105°C without voltage applied.		
	Capacitance Change	±15% of the initial value	
	D.F. (tan δ)	150% of the initial specified value	
	Leakage Current	200% of the initial specified value	

DIMENSIONS[mm]

• Terminal Code : K (22 to 35) : Standard

• Terminal Code : L (35)

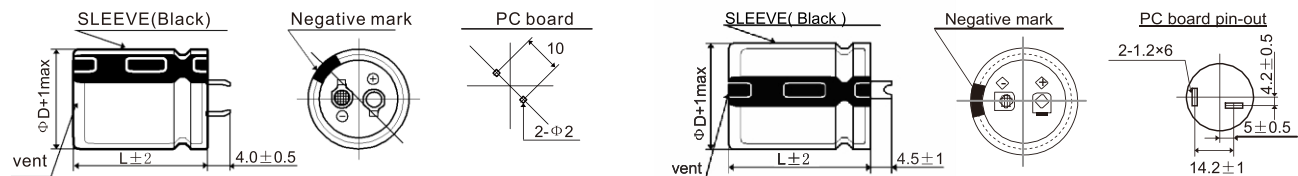

PART NUMBERING SYSTEM

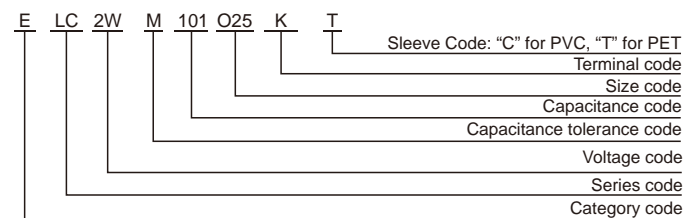

RATED RIPPLE CURRENT MULTIPLIERS

Frequency correction factor for ripple current

Rated voltage(V _{dc}) \ Freq.(Hz)	120	1k	10k	100k
400~500	1.00	1.30	1.41	1.43

The endurance of capacitors is shortened with internal heating produced by ripple current at the rate of halving the lifetime with every 5°C rise. When long life performance is required in actual use, the rms ripple current has to be reduced.

LC series

■ STANDARD RATINGS

WV (Vdc)	Cap (μF)	Size DxL(mm)	tan	Rated ripple current (Arms/105°C, 120Hz)	Part Number
400(2G)	100	22x25	0.15	0.70	ELC2GM101O25KT
	120	22x30	0.15	0.75	ELC2GM121O30KT
	150	22x30	0.15	0.88	ELC2GM151O30KT
		25x25	0.15	0.88	ELC2GM151P25KT
	180	22x35	0.15	0.95	ELC2GM181O35KT
		25x30	0.15	0.95	ELC2GM181P30KT
	220	22x45	0.15	1.10	ELC2GM221O45KT
		25x35	0.15	1.10	ELC2GM221P35KT
		30x25	0.15	1.10	ELC2GM221Q25KT
	270	22x50	0.15	1.22	ELC2GM271O50KT
		25x40	0.15	1.22	ELC2GM271P40KT
		30x30	0.15	1.22	ELC2GM271Q30KT
		35x25	0.15	1.22	ELC2GM271R25KT
	330	25x45	0.15	1.44	ELC2GM331P45KT
		30x35	0.15	1.44	ELC2GM331Q35KT
		35x30	0.15	1.44	ELC2GM331R30KT
	390	25x50	0.15	1.55	ELC2GM391P50KT
		30x40	0.15	1.55	ELC2GM391Q40KT
		35x30	0.15	1.55	ELC2GM391R30KT
	470	30x45	0.15	1.68	ELC2GM471Q45KT
		35x35	0.15	1.68	ELC2GM471R35KT
	560	30x50	0.15	1.90	ELC2GM561Q50KT
		35x40	0.15	1.90	ELC2GM561R40KT
	680	35x45	0.15	2.12	ELC2GM681R45KT
450(2W)	100	22x25	0.20	0.71	ELC2WM101O25KT
	120	22x30	0.20	0.82	ELC2WM121O30KT
	150	22x35	0.20	0.94	ELC2WM151O35KT
		25x30	0.20	0.89	ELC2WM151P30KT
	180	22x40	0.20	1.05	ELC2WM181O40KT
		25x30	0.20	1.00	ELC2WM181P30KT
	220	22x45	0.20	1.19	ELC2WM221O45KT
		25x35	0.20	1.16	ELC2WM221P35KT
		30x30	0.20	1.11	ELC2WM221Q30KT
	270	22x50	0.20	1.36	ELC2WM271O50KT
		25x40	0.20	1.32	ELC2WM271P40KT
		30x30	0.20	1.26	ELC2WM271Q30KT
		35x25	0.20	1.26	ELC2WM271R25KT
	330	25x50	0.20	1.52	ELC2WM331P50KT
		30x35	0.20	1.45	ELC2WM331Q35KT
		35x30	0.20	1.45	ELC2WM331R30KT
	390	30x40	0.20	1.63	ELC2WM391Q40KT
		30x45	0.20	1.85	ELC2WM471Q45KT
	470	30x50	0.20	1.90	ELC2WM471Q50KT
		35x35	0.20	1.77	ELC2WM471R35KT
		560	35x40	0.20	2.02
	680	35x50	0.20	2.36	ELC2WM681R50KT

WV (Vdc)	Cap (μF)	Size DxL(mm)	tan	Rated ripple current (Arms/105°C, 120Hz)	Part Number
500(2H)	47	22x25	0.20	0.51	ELC2HM470O25KT
	56	22x25	0.20	0.58	ELC2HM560O25KT
	68	25x25	0.20	0.65	ELC2HM680P25KT
	82	22x35	0.20	0.72	ELC2HM820O35KT
		25x30	0.20	0.74	ELC2HM820P30KT
	100	22x40	0.20	0.83	ELC2HM101O40KT
		25x30	0.20	0.82	ELC2HM101P30KT
	120	22x45	0.20	0.93	ELC2HM121O45KT
		25x35	0.20	0.93	ELC2HM121P35KT
		30x30	0.20	0.91	ELC2HM121Q30KT
	150	25x40	0.20	1.08	ELC2HM151P40KT
		30x35	0.20	1.04	ELC2HM151Q35KT
		35x25	0.20	0.99	ELC2HM151R25KT
		25x50	0.20	1.20	ELC2HM181P50KT
	180	30x40	0.20	1.17	ELC2HM181Q40KT
		35x30	0.20	1.10	ELC2HM181R30KT
		30x45	0.20	1.33	ELC2HM221Q45KT
	220	35x35	0.20	1.23	ELC2HM221R35KT
		30x50	0.20	1.50	ELC2HM271Q50KT
	270	35x40	0.20	1.42	ELC2HM271R40KT
		330	35x45	0.20	1.60
	390	35x50	0.20	1.78	ELC2HM391R50KT
	470	35x60	0.20	2.03	ELC2HM471R60KT

Snap-in&Lug Terminal Type

LS series

- Downsized, longer life series
- Endurance: 3,000 hours at 85°C
- Non solvent-proof type
- **RoHS Compliant**



SPECIFICATIONS

Items	Characteristics			
Category Temperature Range	-25~+85°C			
Rated Voltage Range	160~600V.DC			
Capacitance Tolerance	±20%(M) (at 20°C, 120Hz)			
Leakage Current	$I \leq 3\sqrt{CV}$ Where, I:Max.leakage current (µA), C:Nominal capacitance (µF), V: Rated voltage (V) (at 20°C after 5 minutes)			
Dissipation Factor (tan δ)	Rated Voltage(V _{dc})	160 to 400	420 to 550	600
	tan δ (max.)	0.15	0.20	0.30
Low Temperature Characteristics (Max. Impedance Ratio)	Rated Voltage(V _{dc})	160 to 400	420 to 550	600
	Z(-25°C)/Z(+20°C)	4	8	10
Endurance	The following specifications shall be satisfied when the capacitors are restored to 20°C after DC voltage plus the rated ripple current is applied for 3,000 hours at 85°C.			
	Capacitance Change	±20% of the initial value		
	D.F. (tan δ)	200% of the initial specified value		
	Leakage Current	The initial specified value		
Shelf Life	The following specifications shall be satisfied when the capacitors are restored to 20°C after exposing them for 1,000 hours at 85°C without voltage applied.			
	Capacitance Change	±15% of the initial value		
	D.F. (tan δ)	150% of the initial specified value		
	Leakage Current	200% of the initial specified value		

DIMENSIONS[mm]

- Terminal Code : K (22 to 35) : Standard

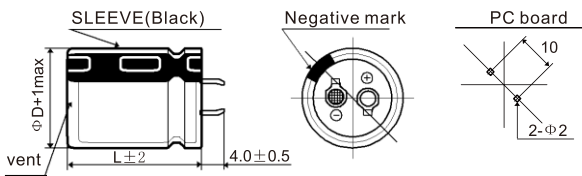

- Terminal Code : L (35)

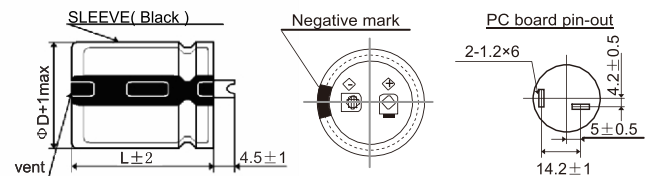

PART NUMBERING SYSTEM

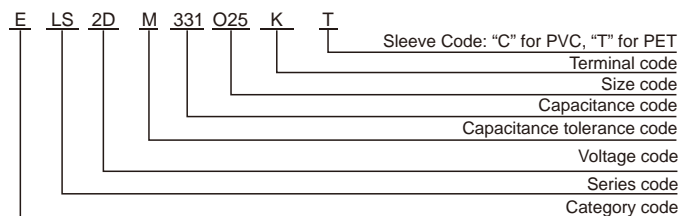

RATED RIPPLE CURRENT MULTIPLIERS

Frequency correction factor for ripple current

Rated voltage(V _{dc})	Freq.(Hz)			
	120	1k	10k	100k
160~250	1.00	1.32	1.45	1.50
315~600	1.00	1.30	1.41	1.43

The endurance of capacitors is shortened with internal heating produced by ripple current at the rate of halving the lifetime with every 5°C rise. When long life performance is required in actual use, the rms ripple current has to be reduced.

LS series

■ STANDARD RATINGS

WV (Vdc)	Cap (μF)	Size DxL(mm)	tan	Rated ripple current (Arms/85°C, 120Hz)	Part Number
160(2C)	270	22x20	0.15	1.30	ELS2CM271O20KT
	330	22x25	0.15	1.55	ELS2CM331O25KT
	390	22x25	0.15	1.63	ELS2CM391O25KT
		25x20	0.15	1.62	ELS2CM391P20KT
	470	22x30	0.15	1.86	ELS2CM471O30KT
		25x25	0.15	1.86	ELS2CM471P25KT
	560	22x30	0.15	2.15	ELS2CM561O30KT
		25x25	0.15	2.15	ELS2CM561P25KT
		30x20	0.15	2.05	ELS2CM561Q20KT
	680	22x35	0.15	2.35	ELS2CM681O35KT
		25x30	0.15	2.33	ELS2CM681P30KT
		30x25	0.15	2.33	ELS2CM681Q25KT
		35x20	0.15	2.26	ELS2CM681R20KT
	820	22x40	0.15	2.68	ELS2CM821O40KT
		25x30	0.15	2.65	ELS2CM821P30KT
		30x25	0.15	2.64	ELS2CM821Q25KT
		35x20	0.15	2.49	ELS2CM821R20KT
	1000	22x45	0.15	3.02	ELS2CM102O45KT
		25x35	0.15	3.00	ELS2CM102P35KT
		30x30	0.15	3.96	ELS2CM102Q30KT
		35x25	0.15	3.13	ELS2CM102R25KT
	1200	22x50	0.15	3.47	ELS2CM122O50KT
		25x40	0.15	3.43	ELS2CM122P40KT
		30x30	0.15	3.41	ELS2CM122Q30KT
	1500	35x25	0.15	3.40	ELS2CM122R25KT
		25x50	0.15	3.96	ELS2CM152P50KT
		30x35	0.15	3.96	ELS2CM152Q35KT
	1800	35x30	0.15	3.94	ELS2CM152R30KT
		30x40	0.15	4.31	ELS2CM182Q40KT
	2200	35x35	0.15	4.28	ELS2CM182R35KT
		30x50	0.15	4.96	ELS2CM222Q50KT
	2700	35x40	0.15	4.96	ELS2CM222R40KT
		35x45	0.15	5.57	ELS2CM272R45KT
3300	35x50	0.15	6.21	ELS2CM332R50KT	
180(2L)	220	22x20	0.15	1.18	ELS2LM221O20KT
	330	22x25	0.15	1.77	ELS2LM331O25KT
	390	25x20	0.15	1.49	ELS2LM331P20KT
		22x25	0.15	1.84	ELS2LM391O25KT
	470	22x30	0.15	1.91	ELS2LM471O30KT
		25x25	0.15	2.08	ELS2LM471P25KT
	560	30x20	0.15	1.88	ELS2LM471Q20KT
		22x35	0.15	2.25	ELS2LM561O35KT
		25x25	0.15	2.25	ELS2LM561P25KT
	680	22x35	0.15	2.48	ELS2LM681O35KT
		25x30	0.15	2.50	ELS2LM681P30KT
		30x25	0.15	2.46	ELS2LM681Q25KT
	820	35x20	0.15	2.26	ELS2LM681R20KT
		22x40	0.15	2.86	ELS2LM821O40KT
		25x35	0.15	2.75	ELS2LM821P35KT
		30x25	0.15	2.69	ELS2LM821Q25KT
	1000	22x50	0.15	3.10	ELS2LM102O50KT
		25x40	0.15	3.06	ELS2LM102P40KT
		30x30	0.15	3.10	ELS2LM102Q30KT
		35x25	0.15	2.98	ELS2LM102R25KT
	1200	25x45	0.15	3.63	ELS2LM122P45KT
		30x35	0.15	3.55	ELS2LM122Q35KT
	1500	35x30	0.15	3.49	ELS2LM122R30KT
		30x40	0.15	4.10	ELS2LM152Q40KT
	1800	35x35	0.15	4.02	ELS2LM152R35KT
		30x45	0.15	4.55	ELS2LM182Q45KT
	2200	35x35	0.15	4.54	ELS2LM182R35KT
		35x40	0.15	4.83	ELS2LM222R40KT
	2700	35x50	0.15	5.30	ELS2LM272R50KT

WV (Vdc)	Cap (μF)	Size DxL(mm)	tan	Rated ripple current (Arms/85°C, 120Hz)	Part Number
200(2D)	220	22x20	0.15	1.18	ELS2DM221O20KT
	270	22x25	0.15	1.37	ELS2DM271O25KT
		25x20	0.15	1.35	ELS2DM271P20KT
	330	22x25	0.15	1.51	ELS2DM331O25KT
		25x20	0.15	1.49	ELS2DM331P20KT
	390	22x30	0.15	1.73	ELS2DM391O30KT
		25x25	0.15	1.71	ELS2DM391P25KT
		30x20	0.15	1.71	ELS2DM391Q20KT
	470	22x30	0.15	1.97	ELS2DM471O30KT
		25x25	0.15	1.95	ELS2DM471P25KT
		30x20	0.15	1.88	ELS2DM471Q20KT
		22x35	0.15	2.18	ELS2DM561O35KT
	560	25x30	0.15	2.15	ELS2DM561P30KT
		30x25	0.15	2.15	ELS2DM561Q25KT
		35x20	0.15	2.05	ELS2DM561R20KT
		22x40	0.15	2.48	ELS2DM681O40KT
	680	25x30	0.15	2.48	ELS2DM681P30KT
		30x25	0.15	2.48	ELS2DM681Q25KT
		35x20	0.15	2.36	ELS2DM681R20KT
		22x45	0.15	2.81	ELS2DM821O45KT
	820	25x35	0.15	2.79	ELS2DM821P35KT
		30x30	0.15	2.80	ELS2DM821Q30KT
		35x25	0.15	2.83	ELS2DM821R25KT
	1000	22x50	0.15	3.28	ELS2DM102O50KT
		25x40	0.15	3.28	ELS2DM102P40KT
		30x35	0.15	3.15	ELS2DM102Q35KT
		35x30	0.15	3.26	ELS2DM102R30KT
	1200	25x45	0.15	3.61	ELS2DM122P45KT
		30x35	0.15	3.61	ELS2DM122Q35KT
		35x30	0.15	3.57	ELS2DM122R30KT
	1500	30x45	0.15	4.13	ELS2DM152Q45KT
		35x35	0.15	4.06	ELS2DM152R35KT
	1800	30x50	0.15	4.60	ELS2DM182O50KT
35x40		0.15	4.59	ELS2DM182R40KT	
2200	35x45	0.15	5.25	ELS2DM222R45KT	
220(2N)	180	22x20	0.15	1.06	ELS2NM181O20KT
	270	22x25	0.15	1.47	ELS2NM271O25KT
		25x20	0.15	1.35	ELS2NM271P20KT
	330	22x30	0.15	1.70	ELS2NM331O30KT
		25x25	0.15	1.69	ELS2NM331P25KT
		30x20	0.15	1.58	ELS2NM331Q20KT
	390	22x30	0.15	1.89	ELS2NM391O30KT
		25x25	0.15	1.84	ELS2NM391P25KT
		30x20	0.15	1.71	ELS2NM391Q20KT
	470	22x35	0.15	2.08	ELS2NM471O35KT
		25x30	0.15	2.08	ELS2NM471P30KT
		30x25	0.15	2.12	ELS2NM471Q25KT
		35x20	0.15	1.88	ELS2NM471R20KT
	560	22x40	0.15	2.33	ELS2NM561O40KT
		25x35	0.15	2.38	ELS2NM561P35KT
		30x25	0.15	2.31	ELS2NM561Q25KT
		35x20	0.15	2.14	ELS2NM561R20KT
	680	22x45	0.15	2.63	ELS2NM681O45KT
		25x35	0.15	2.68	ELS2NM681P35KT
		30x30	0.15	2.62	ELS2NM681Q30KT
	820	35x25	0.15	2.58	ELS2NM681R25KT
		25x45	0.15	3.01	ELS2NM821P45KT
		30x35	0.15	2.99	ELS2NM821Q35KT
		35x30	0.15	2.79	ELS2NM821R30KT
	1000	25x50	0.15	3.40	ELS2NM102P50KT
		30x35	0.15	3.42	ELS2NM102Q35KT
		35x30	0.15	3.29	ELS2NM102R30KT
	1200	30x40	0.15	3.88	ELS2NM122Q40KT
		35x35	0.15	3.68	ELS2NM122R35KT
	1500	30x50	0.15	4.44	ELS2NM152Q50KT
		35x40	0.15	4.10	ELS2NM152R40KT
	1800	35x45	0.15	4.52	ELS2NM182R45KT

Snap-in&Lug Terminal Type

LS series

■ STANDARD RATINGS

WV (Vdc)	Cap (μF)	Size DxL(mm)	tan	Rated ripple current (Arms/85°C, 120Hz)	Part Number
250(2E)	150	22x20	0.15	0.97	ELS2EM151O20KT
	180	22x20	0.15	1.06	ELS2EM181O20KT
	220	22x25	0.15	1.24	ELS2EM221O25KT
		25x20	0.15	1.22	ELS2EM221P20KT
	270	22x25	0.15	1.50	ELS2EM271O25KT
		22x30	0.15	1.66	ELS2EM331O30KT
	330	25x25	0.15	1.61	ELS2EM331P25KT
		30x20	0.15	1.58	ELS2EM331Q20KT
		22x35	0.15	1.88	ELS2EM391O35KT
	390	25x30	0.15	1.88	ELS2EM391P30KT
		30x25	0.15	1.86	ELS2EM391Q25KT
		35x20	0.15	1.71	ELS2EM391R20KT
	470	22x35	0.15	2.15	ELS2EM471O35KT
		25x35	0.15	2.15	ELS2EM471P35KT
		30x25	0.15	2.05	ELS2EM471Q25KT
	560	35x20	0.15	1.88	ELS2EM471R20KT
		22x40	0.15	2.48	ELS2EM561O40KT
		25x35	0.15	2.35	ELS2EM561P35KT
	680	30x25	0.15	2.35	ELS2EM561Q25KT
		22x50	0.15	2.61	ELS2EM681O50KT
		25x40	0.15	2.67	ELS2EM681P40KT
	820	30x30	0.15	2.71	ELS2EM681Q30KT
		35x25	0.15	2.58	ELS2EM681R25KT
		25x45	0.15	3.01	ELS2EM821P45KT
1000	30x35	0.15	2.98	ELS2EM821Q35KT	
	35x30	0.15	2.96	ELS2EM821R30KT	
	30x40	0.15	3.56	ELS2EM102Q40KT	
1200	35x35	0.15	3.48	ELS2EM102R35KT	
	30x45	0.15	3.99	ELS2EM122Q45KT	
1500	35x35	0.15	3.84	ELS2EM122R35KT	
	35x40	0.15	4.33	ELS2EM152R40KT	
1800	35x50	0.15	4.54	ELS2EM182R50KT	
315(2F)	100	22x20	0.15	0.79	ELS2FM101O20KT
	120	25x20	0.15	0.90	ELS2FM121P20KT
		22x25	0.15	1.06	ELS2FM151O25KT
	150	25x20	0.15	1.00	ELS2FM151P20KT
		22x30	0.15	1.29	ELS2FM181O30KT
	180	25x25	0.15	1.38	ELS2FM181P25KT
		30x20	0.15	1.16	ELS2FM181Q20KT
	220	22x30	0.15	1.41	ELS2FM221O30KT
		25x25	0.15	1.47	ELS2FM221P25KT
		30x20	0.15	1.28	ELS2FM221Q20KT
	270	22x35	0.15	1.68	ELS2FM271O35KT
		25x30	0.15	1.70	ELS2FM271P30KT
		30x25	0.15	1.55	ELS2FM271Q25KT
	330	35x20	0.15	1.43	ELS2FM271R20KT
		22x40	0.15	1.91	ELS2FM331O40KT
		25x35	0.15	1.94	ELS2FM331P35KT
	390	30x25	0.15	1.98	ELS2FM331Q25KT
		22x45	0.15	2.07	ELS2FM391O45KT
		25x40	0.15	2.11	ELS2FM391P40KT
	470	30x30	0.15	2.15	ELS2FM391Q30KT
		35x25	0.15	1.95	ELS2FM391R25KT
		25x45	0.15	2.31	ELS2FM471P45KT
	560	30x35	0.15	2.38	ELS2FM471Q35KT
		35x30	0.15	2.46	ELS2FM471R30KT
		25x50	0.15	2.46	ELS2FM561P50KT
	680	30x35	0.15	2.63	ELS2FM561P35KT
		35x30	0.15	2.69	ELS2FM561R30KT
		30x45	0.15	2.82	ELS2FM681Q45KT
	820	35x35	0.15	3.05	ELS2FM681R35KT
		30x50	0.15	3.28	ELS2FM821R40KT
	1000	35x40	0.15	3.45	ELS2FM821R40KT
	1000	35x45	0.15	3.59	ELS2FM102R45KT

WV (Vdc)	Cap (μF)	Size DxL(mm)	tan	Rated ripple current (Arms/85°C, 120Hz)	Part Number	
350(2V)	82	22x20	0.15	0.72	ELS2VM820O20KT	
	120	22x25	0.15	1.04	ELS2VM121O25KT	
		25x20	0.15	0.90	ELS2VM121P20KT	
	150	22x30	0.15	1.20	ELS2VM151O30KT	
		25x25	0.15	1.22	ELS2VM151P25KT	
		30x20	0.15	1.06	ELS2VM151Q20KT	
	180	22x30	0.15	1.34	ELS2VM181O30KT	
		25x25	0.15	1.37	ELS2VM181P25KT	
		30x20	0.15	1.16	ELS2VM181Q20KT	
	220	22x35	0.15	1.47	ELS2VM221O35KT	
		25x30	0.15	1.53	ELS2VM221P30KT	
		30x25	0.15	1.54	ELS2VM221Q25KT	
	270	35x20	0.15	1.29	ELS2VM221R20KT	
		22x40	0.15	1.70	ELS2VM271O40KT	
		25x35	0.15	1.73	ELS2VM271P35KT	
	330	30x25	0.15	1.80	ELS2VM271Q25KT	
		35x20	0.15	1.49	ELS2VM271R20KT	
		22x45	0.15	1.87	ELS2VM331O45KT	
	390	25x35	0.15	1.97	ELS2VM331P35KT	
		30x30	0.15	2.03	ELS2VM331Q30KT	
		35x25	0.15	1.80	ELS2VM331R25KT	
	470	25x40	0.15	2.14	ELS2VM391P40KT	
		30x35	0.15	2.23	ELS2VM391Q35KT	
		35x30	0.15	2.30	ELS2VM391R30KT	
	560	25x50	0.15	2.55	ELS2VM471P50KT	
		30x35	0.15	2.53	ELS2VM471Q35KT	
		35x30	0.15	2.55	ELS2VM471R30KT	
	680	30x40	0.15	2.73	ELS2VM561Q40KT	
		35x35	0.15	2.75	ELS2VM561R35KT	
		30x50	0.15	3.15	ELS2VM681Q50KT	
	820	35x40	0.15	3.15	ELS2VM681R40KT	
		35x45	0.15	3.47	ELS2VM821R45KT	
	1000	35x50	0.15	3.60	ELS2VM102R50KT	
	400(2G)	68	22x20	0.15	0.65	ELS2GM680O20KT
		82	22x25	0.15	0.84	ELS2GM820O25KT
			25x20	0.15	0.74	ELS2GM820P20KT
		100	22x25	0.15	0.99	ELS2GM101O25KT
			25x20	0.15	0.82	ELS2GM101P20KT
		120	22x30	0.15	1.09	ELS2GM121O30KT
			25x25	0.15	1.13	ELS2GM121P25KT
			30x20	0.15	0.95	ELS2GM121Q20KT
		150	22x35	0.15	1.24	ELS2GM151O35KT
25x30			0.15	1.27	ELS2GM151P30KT	
30x25			0.15	1.20	ELS2GM151Q25KT	
180		22x40	0.15	1.41	ELS2GM181O40KT	
		25x30	0.15	1.44	ELS2GM181P30KT	
		30x25	0.15	1.52	ELS2GM181Q25KT	
220		35x20	0.15	1.16	ELS2GM181R20KT	
		22x45	0.15	1.58	ELS2GM221O45KT	
		25x35	0.15	1.64	ELS2GM221P35KT	
270		30x30	0.15	1.66	ELS2GM221Q30KT	
		35x25	0.15	1.47	ELS2GM221R25KT	
		22x50	0.15	1.65	ELS2GM271O50KT	
330		25x40	0.15	1.79	ELS2GM271P40KT	
		30x30	0.15	1.82	ELS2GM271Q30KT	
		35x25	0.15	1.63	ELS2GM271R25KT	
390		25x45	0.15	2.00	ELS2GM331P45KT	
		30x35	0.15	2.05	ELS2GM331Q35KT	
		35x30	0.15	2.05	ELS2GM331R30KT	
470		25x50	0.15	2.12	ELS2GM391P50KT	
		30x40	0.15	2.26	ELS2GM391Q40KT	
		35x35	0.15	2.28	ELS2GM391R35KT	
560		30x45	0.15	2.51	ELS2GM471Q45KT	
		35x35	0.15	2.54	ELS2GM471R35KT	
		30x50	0.15	2.85	ELS2GM561Q50KT	
680		35x40	0.15	2.85	ELS2GM561R40KT	
		35x50	0.15	3.10	ELS2GM681R50KT	

LS series

■ STANDARD RATINGS

WV (Vdc)	Cap (μF)	Size DxL(mm)	tan	Rated ripple current (Arms/85°C, 120Hz)	Part Number	
420(2T)	47	22x20	0.20	0.54	ELS2TM470O20KT	
	56	22x20	0.20	0.59	ELS2TM560O20KT	
	68	25x20	0.20	0.68	ELS2TM680P20KT	
	82	22x25	0.20	0.85	ELS2TM820O25KT	
		25x20	0.20	0.74	ELS2TM820P20KT	
	100	22x30	0.20	0.97	ELS2TM101O30KT	
		25x25	0.20	0.98	ELS2TM101P25KT	
		30x20	0.20	0.87	ELS2TM101Q20KT	
	120	22x30	0.20	1.07	ELS2TM121O30KT	
		25x25	0.20	1.08	ELS2TM121P25KT	
		30x20	0.20	0.95	ELS2TM121Q20KT	
	150	22x35	0.20	1.21	ELS2TM151O35KT	
		25x30	0.20	1.26	ELS2TM151P30KT	
		30x25	0.20	1.30	ELS2TM151Q25KT	
		35x20	0.20	1.11	ELS2TM151R20KT	
	180	22x40	0.20	1.33	ELS2TM181O40KT	
		25x35	0.20	1.42	ELS2TM181P35KT	
		30x25	0.20	1.48	ELS2TM181Q25KT	
		35x20	0.20	1.16	ELS2TM181R20KT	
	220	22x45	0.20	1.55	ELS2TM221O45KT	
		25x35	0.20	1.58	ELS2TM221P35KT	
		30x30	0.20	1.65	ELS2TM221Q30KT	
		35x25	0.20	1.47	ELS2TM221R25KT	
	270	25x40	0.20	1.74	ELS2TM271P40KT	
		30x35	0.20	1.90	ELS2TM271Q35KT	
		35x30	0.20	1.94	ELS2TM271R30KT	
	330	25x50	0.20	2.20	ELS2TM331P50KT	
		30x35	0.20	1.98	ELS2TM331Q35KT	
		35x35	0.20	2.17	ELS2TM331R35KT	
	390	30x40	0.20	2.22	ELS2TM391Q40KT	
		35x35	0.20	2.27	ELS2TM391R35KT	
	470	30x45	0.20	2.50	ELS2TM471Q45KT	
		35x40	0.20	2.61	ELS2TM471R40KT	
	560	35x45	0.20	2.95	ELS2TM561R45KT	
	680	35x50	0.20	3.15	ELS2TM681R50KT	
	450(2W)	47	22x20	0.20	0.54	ELS2WM470O20KT
		56	22x20	0.20	0.59	ELS2WM560O20KT
		68	22x25	0.20	0.71	ELS2WM680O25KT
			25x20	0.20	0.68	ELS2WM680P20KT
		82	22x25	0.20	0.86	ELS2WM820O25KT
25x20			0.20	0.74	ELS2WM820P20KT	
30x20			0.20	0.79	ELS2WM820Q20KT	
100		22x30	0.20	0.95	ELS2WM101O30KT	
		25x25	0.20	0.97	ELS2WM101P25KT	
		30x20	0.20	0.87	ELS2WM101Q20KT	
120		22x35	0.20	1.07	ELS2WM121O35KT	
		25x30	0.20	1.09	ELS2WM121P30KT	
		30x25	0.20	1.12	ELS2WM121Q25KT	
		35x20	0.20	0.99	ELS2WM121R20KT	
150		22x40	0.20	1.18	ELS2WM151O40KT	
		25x30	0.20	1.25	ELS2WM151P30KT	
		30x25	0.20	1.29	ELS2WM151Q25KT	
		35x20	0.20	1.06	ELS2WM151R20KT	
180		22x45	0.20	1.32	ELS2WM181O45KT	
		25x35	0.20	1.40	ELS2WM181P35KT	
		30x30	0.20	1.45	ELS2WM181Q30KT	
		35x25	0.20	1.33	ELS2WM181R25KT	
220		22x50	0.20	1.48	ELS2WM221O50KT	
		25x40	0.20	1.59	ELS2WM221P40KT	
		30x30	0.20	1.64	ELS2WM221Q30KT	
		35x25	0.20	1.66	ELS2WM221R25KT	
270		25x45	0.20	1.73	ELS2WM271P45KT	
		30x35	0.20	1.89	ELS2WM271Q35KT	
		35x30	0.20	1.90	ELS2WM271R30KT	
330		25x50	0.20	2.12	ELS2WM331P50KT	
		30x40	0.20	2.12	ELS2WM331Q40KT	
		35x35	0.20	2.15	ELS2WM331R35KT	
390		30x45	0.20	2.35	ELS2WM391Q45KT	
		35x40	0.20	2.38	ELS2WM391R40KT	
470		30x50	0.20	2.65	ELS2WM471Q50KT	
		35x45	0.20	2.68	ELS2WM471R45KT	
560		35x50	0.20	2.88	ELS2WM561R50KT	

WV (Vdc)	Cap (μF)	Size DxL(mm)	tan	Rated ripple current (Arms/85°C, 120Hz)	Part Number	
500(2H)	47	22x20	0.20	0.59	ELS2HM470O20KT	
	56	22x25	0.20	0.61	ELS2HM560O25KT	
		25x20	0.20	0.62	ELS2HM560P20KT	
	68	22x30	0.20	0.75	ELS2HM680O30KT	
		25x25	0.20	0.78	ELS2HM680P25KT	
	82	22x30	0.20	0.92	ELS2HM820O30KT	
		25x25	0.20	0.95	ELS2HM820P25KT	
	100	22x35	0.20	1.02	ELS2HM101O35KT	
		25x30	0.20	1.06	ELS2HM101P30KT	
		30x25	0.20	1.01	ELS2HM101Q25KT	
	120	22x40	0.20	1.12	ELS2HM121O40KT	
		25x35	0.20	1.23	ELS2HM121P35KT	
		30x30	0.20	1.20	ELS2HM121Q30KT	
	150	22x45	0.20	1.22	ELS2HM151O45KT	
		25x40	0.20	1.26	ELS2HM151P40KT	
		30x30	0.20	1.34	ELS2HM151Q30KT	
		22x50	0.20	1.39	ELS2HM181O50KT	
	180	25x45	0.20	1.45	ELS2HM181P45KT	
		30x35	0.20	1.47	ELS2HM181Q35KT	
		25x50	0.20	1.52	ELS2HM221P50KT	
	220	30x40	0.20	1.60	ELS2HM221Q40KT	
		30x45	0.20	1.98	ELS2HM271Q45KT	
	270	35x35	0.20	2.02	ELS2HM271R35KT	
		30x50	0.20	2.25	ELS2HM331Q50KT	
	330	35x40	0.20	2.27	ELS2HM331R40KT	
		35x45	0.20	2.45	ELS2HM391R45KT	
	390	35x50	0.20	2.76	ELS2HM471R50KT	
		35x60	0.20	2.90	ELS2HM561R60KT	
	550(2J)	47	22x25	0.20	0.59	ELS2JM470O25KT
		56	22x30	0.20	0.63	ELS2JM560O30KT
		68	22x30	0.20	0.76	ELS2JM680O30KT
			25x25	0.20	0.72	ELS2JM680P25KT
		82	22x35	0.20	0.91	ELS2JM820O35KT
			25x30	0.20	0.89	ELS2JM820P30KT
			30x25	0.20	0.88	ELS2JM820Q25KT
		100	22x40	0.20	0.97	ELS2JM101O40KT
			25x35	0.20	0.97	ELS2JM101P35KT
			30x25	0.20	0.92	ELS2JM101Q25KT
			22x45	0.20	1.07	ELS2JM121O45KT
		120	25x40	0.20	1.16	ELS2JM121P40KT
30x30			0.20	1.12	ELS2JM121Q30KT	
25x45			0.20	1.25	ELS2JM151P45KT	
150		30x35	0.20	1.29	ELS2JM151Q35KT	
		35x30	0.20	1.29	ELS2JM151R30KT	
		25x50	0.20	1.40	ELS2JM181P50KT	
180		30x40	0.20	1.45	ELS2JM181Q40KT	
		35x30	0.20	1.36	ELS2JM181R30KT	
		30x45	0.20	1.61	ELS2JM221Q45KT	
220		35x35	0.20	1.60	ELS2JM221R35KT	
		35x40	0.20	2.00	ELS2JM271R40KT	
270		35x45	0.20	2.26	ELS2JM331R45KT	
		35x50	0.20	2.45	ELS2JM391R50KT	
470		35x60	0.20	2.80	ELS2JM471R60KT	
600(2K)		47	22x30	0.30	0.59	ELS2KM470O30KT
		56	22x35	0.30	0.63	ELS2KM560O35KT
			25x30	0.30	0.62	ELS2KM560P30KT
		68	22x40	0.30	0.76	ELS2KM680O40KT
			25x35	0.30	0.76	ELS2KM680P35KT
		82	22x45	0.30	0.92	ELS2KM820O45KT
			25x40	0.30	0.90	ELS2KM820P40KT
		100	25x45	0.30	1.01	ELS2KM101P45KT
			30x35	0.30	1.01	ELS2KM101Q35KT
			25x50	0.30	1.16	ELS2KM121P50KT
		120	30x40	0.30	1.16	ELS2KM121Q40KT
			30x45	0.30	1.29	ELS2KM151Q45KT
		150	30x50	0.30	1.45	ELS2KM181Q50KT
			35x40	0.30	1.45	ELS2KM181R40KT
		220	35x45	0.30	1.61	ELS2KM221R45KT
	35x50		0.30	2.02	ELS2KM271R50KT	
	330	35x60	0.30	2.27	ELS2KM331R60KT	

Snap-in&Lug Terminal Type

LM series

- Downsized, longer life
- Endurance: 3,000 hours at 105°C
- RoHS Compliant



SPECIFICATIONS

Items	Characteristics		
Category Temperature Range	-25~+105°C		
Rated Voltage Range	160~550V.DC		
Capacitance Tolerance	±20%(M) (at 20°C, 120Hz)		
Leakage Current	$I \leq 3\sqrt{CV}$ Where, I:Max.leakage current (µA), C:Nominal capacitance (µF), V: Rated voltage (V) (at 20°C after 5 minutes)		
Dissipation Factor (tan δ)	Rated Voltage(V _{dc})	160 to 400	420 to 550
	tan δ (max.)	0.15	0.20
Low Temperature Characteristics (Max. Impedance Ratio)	Rated Voltage(V _{dc})	160 to 250	315 to 550
	Z(-25°C)/Z(+20°C)	4	8
Endurance	The following specifications shall be satisfied when the capacitors are restored to 20°C after DC voltage plus the rated ripple current is applied for 3,000 hours at 105 °C.		
	Capacitance Change	±20% of the initial value	
	D.F. (tan δ)	200% of the initial specified value	
	Leakage Current	The initial specified value	
Shelf Life	The following specifications shall be satisfied when the capacitors are restored to 20°C after exposing them for 1,000 hours at 105°C without voltage applied.		
	Capacitance Change	±15% of the initial value	
	D.F. (tan δ)	150% of the initial specified value	
	Leakage Current	200% of the initial specified value	

DIMENSIONS[mm]

- Terminal Code : K (22 to 35) : Standard

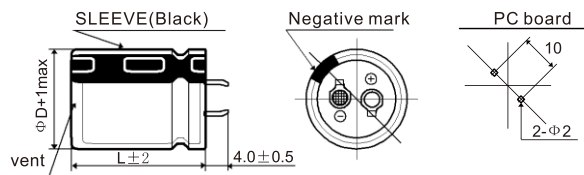

- Terminal Code : L (35)

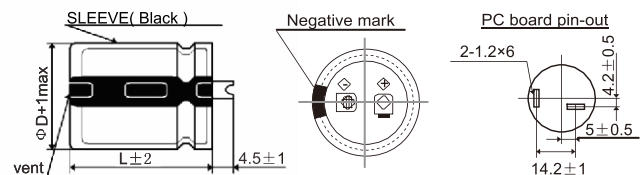

PART NUMBERING SYSTEM

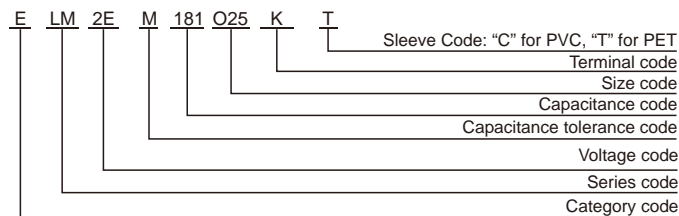

RATED RIPPLE CURRENT MULTIPLIERS

Frequency correction factor for ripple current

Rated voltage(V _{dc}) \ Freq.(Hz)	120	1k	10k	100k
160~250	1.00	1.32	1.45	1.50
315~550	1.00	1.30	1.41	1.43

The endurance of capacitors is shortened with internal heating produced by ripple current at the rate of halving the lifetime with every 5°C rise. When long life performance is required in actual use, the rms ripple current has to be reduced.

LM series

■ STANDARD RATINGS

VV (Vdc)	Cap (μF)	Size DxL(mm)	tan	Rated ripple current (Arms/105°C, 120Hz)	Part Number
160(2C)	220	22x20	0.15	0.81	ELM2CM221O20KT
	270	25x20	0.15	0.98	ELM2CM271P20KT
	330	22x25	0.15	1.20	ELM2CM331O25KT
	330	25x20	0.15	1.02	ELM2CM331P20KT
		22x25	0.15	1.30	ELM2CM391O25KT
		25x25	0.15	1.26	ELM2CM391P25KT
	390	30x20	0.15	1.25	ELM2CM391Q20KT
		22x30	0.15	1.55	ELM2CM471O30KT
		25x25	0.15	1.55	ELM2CM471P25KT
	470	30x20	0.15	1.30	ELM2CM471Q20KT
		22x35	0.15	1.67	ELM2CM561O35KT
		25x30	0.15	1.67	ELM2CM561P30KT
	560	30x25	0.15	1.67	ELM2CM561Q25KT
		35x20	0.15	1.46	ELM2CM561R20KT
		22x40	0.15	1.82	ELM2CM681O40KT
	680	25x30	0.15	1.82	ELM2CM681P30KT
		30x25	0.15	1.82	ELM2CM681Q25KT
		35x20	0.15	1.51	ELM2CM681R20KT
	820	22x45	0.15	2.04	ELM2CM821O45KT
		25x35	0.15	2.04	ELM2CM821P35KT
		30x30	0.15	2.04	ELM2CM821Q30KT
	1000	35x25	0.15	2.04	ELM2CM821R25KT
		22x50	0.15	2.25	ELM2CM102O50KT
		25x40	0.15	2.25	ELM2CM102P40KT
	1200	30x30	0.15	2.25	ELM2CM102Q30KT
		35x25	0.15	2.25	ELM2CM102R25KT
		25x45	0.15	2.49	ELM2CM122P45KT
	1500	30x35	0.15	2.49	ELM2CM122Q35KT
		35x30	0.15	2.49	ELM2CM122R30KT
		25x60	0.15	2.97	ELM2CM152P60KT
	1800	30x40	0.15	2.84	ELM2CM152Q40KT
		35x30	0.15	2.84	ELM2CM152R30KT
		30x45	0.15	3.32	ELM2CM182Q45KT
2200	35x35	0.15	3.00	ELM2CM182R35KT	
	30x60	0.15	3.86	ELM2CM222Q60KT	
	35x45	0.15	3.50	ELM2CM222R45KT	
2700	35x50	0.15	4.00	ELM2CM272R50KT	
3300	35x60	0.15	4.63	ELM2CM332R60KT	
180(2L)	180	22x20	0.15	0.80	ELM2LM181O20KT
	220	25x20	0.15	0.90	ELM2LM221P20KT
	270	22x25	0.15	1.00	ELM2LM271O25KT
	270	25x20	0.15	0.95	ELM2LM271P20KT
		22x25	0.15	1.20	ELM2LM331O25KT
		25x25	0.15	1.16	ELM2LM331P25KT
	330	30x20	0.15	1.15	ELM2LM331Q20KT
		22x30	0.15	1.35	ELM2LM391O30KT
		25x25	0.15	1.35	ELM2LM391P25KT
	390	30x20	0.15	1.20	ELM2LM391Q20KT
		22x35	0.15	1.50	ELM2LM471O35KT
		25x30	0.15	1.50	ELM2LM471P30KT
	470	30x25	0.15	1.50	ELM2LM471Q25KT
		35x20	0.15	1.36	ELM2LM471R20KT
		22x40	0.15	1.67	ELM2LM561O40KT
	560	25x30	0.15	1.67	ELM2LM561P30KT
		30x25	0.15	1.67	ELM2LM561Q25KT
		35x20	0.15	1.43	ELM2LM561R20KT
	680	22x45	0.15	1.78	ELM2LM681O45KT
		25x35	0.15	1.78	ELM2LM681P35KT
		30x30	0.15	1.78	ELM2LM681Q30KT
	820	35x25	0.15	1.83	ELM2LM681R25KT
		22x50	0.15	2.04	ELM2LM821O50KT
		25x40	0.15	2.04	ELM2LM821P40KT
	1000	30x30	0.15	2.04	ELM2LM821Q30KT
		35x25	0.15	2.04	ELM2LM821R25KT
		25x45	0.15	2.30	ELM2LM102P45KT
	1200	30x35	0.15	2.30	ELM2LM102Q35KT
		35x30	0.15	2.30	ELM2LM102R30KT
		25x50	0.15	2.55	ELM2LM122P50KT
	1500	30x40	0.15	2.55	ELM2LM122Q40KT
		35x30	0.15	2.55	ELM2LM122R30KT
		30x45	0.15	2.90	ELM2LM152Q45KT
1800	35x35	0.15	2.90	ELM2LM152R35KT	
	30x60	0.15	3.49	ELM2LM182Q60KT	
	35x40	0.15	3.30	ELM2LM182R40KT	
2200	35x50	0.15	3.65	ELM2LM222R50KT	
2700	35x60	0.15	4.19	ELM2LM272R60KT	

VV (Vdc)	Cap (μF)	Size DxL(mm)	tan	Rated ripple current (Arms/105°C, 120Hz)	Part Number
200(2D)	150	22x20	0.15	0.73	ELM2DM151O20KT
	180	22x20	0.15	0.80	ELM2DM181O20KT
	220	25x20	0.15	0.85	ELM2DM221P20KT
	270	22x25	0.15	1.10	ELM2DM271O25KT
		30x20	0.15	1.05	ELM2DM271Q20KT
		22x30	0.15	1.25	ELM2DM331O30KT
	330	25x25	0.15	1.25	ELM2DM331P25KT
		30x20	0.15	1.10	ELM2DM331Q20KT
		22x30	0.15	1.35	ELM2DM391O30KT
	390	25x25	0.15	1.35	ELM2DM391P25KT
		35x20	0.15	1.30	ELM2DM391R20KT
		22x35	0.15	1.50	ELM2DM471O35KT
	470	25x30	0.15	1.50	ELM2DM471P30KT
		30x25	0.15	1.50	ELM2DM471Q25KT
		35x20	0.15	1.41	ELM2DM471R20KT
	560	22x40	0.15	1.67	ELM2DM561O40KT
		25x30	0.15	1.67	ELM2DM561P30KT
		30x25	0.15	1.67	ELM2DM561Q25KT
	680	22x45	0.15	1.78	ELM2DM681O45KT
		25x35	0.15	1.78	ELM2DM681P35KT
		30x30	0.15	1.78	ELM2DM681Q30KT
	820	35x25	0.15	1.78	ELM2DM681R25KT
		25x45	0.15	2.04	ELM2DM821P45KT
		30x30	0.15	2.04	ELM2DM821Q30KT
	1000	35x25	0.15	2.04	ELM2DM821R25KT
		25x50	0.15	2.30	ELM2DM102P50KT
		30x35	0.15	2.30	ELM2DM102Q35KT
	1200	35x30	0.15	2.30	ELM2DM102R30KT
		25x60	0.15	2.66	ELM2DM122P60KT
		30x40	0.15	2.65	ELM2DM122Q40KT
	1500	35x35	0.15	2.65	ELM2DM122R35KT
		30x50	0.15	3.08	ELM2DM152Q50KT
		35x40	0.15	3.08	ELM2DM152R40KT
1800	30x60	0.15	3.49	ELM2DM182Q60KT	
	35x45	0.15	3.48	ELM2DM182R45KT	
	2200	35x50	0.15	3.78	ELM2DM222R50KT
220(2N)	150	22x20	0.15	0.67	ELM2NM151O20KT
	180	25x20	0.15	0.76	ELM2NM181P20KT
	220	22x25	0.15	1.00	ELM2NM221O25KT
	270	25x20	0.15	0.84	ELM2NM221P20KT
		22x30	0.15	1.15	ELM2NM271O30KT
		25x25	0.15	1.08	ELM2NM271P25KT
	330	30x20	0.15	0.98	ELM2NM271Q20KT
		22x35	0.15	1.25	ELM2NM331O35KT
		25x25	0.15	1.25	ELM2NM331P25KT
	390	35x20	0.15	1.13	ELM2NM331R20KT
		22x35	0.15	1.40	ELM2NM391O35KT
		25x30	0.15	1.40	ELM2NM391P30KT
	470	30x25	0.15	1.36	ELM2NM391Q25KT
		35x20	0.15	1.23	ELM2NM391R20KT
		22x40	0.15	1.51	ELM2NM471O40KT
	560	25x35	0.15	1.54	ELM2NM471P35KT
		30x25	0.15	1.50	ELM2NM471Q25KT
		22x45	0.15	1.70	ELM2NM561O45KT
	680	25x40	0.15	1.72	ELM2NM561P40KT
		30x30	0.15	1.70	ELM2NM561Q30KT
		35x25	0.15	1.71	ELM2NM561R25KT
	820	25x45	0.15	1.94	ELM2NM681P45KT
		30x35	0.15	1.93	ELM2NM681Q35KT
		35x25	0.15	1.89	ELM2NM681R25KT
	1000	25x50	0.15	2.18	ELM2NM821P50KT
		30x40	0.15	2.19	ELM2NM821Q40KT
		35x30	0.15	2.16	ELM2NM821R30KT
	1200	35x30	0.15	2.16	ELM2NM821R30KT
		25x60	0.15	2.54	ELM2NM102P60KT
		30x45	0.15	2.50	ELM2NM102Q45KT
	1500	35x35	0.15	2.44	ELM2NM102R35KT
		30x50	0.15	2.81	ELM2NM122Q50KT
		35x40	0.15	2.79	ELM2NM122R40KT
1800	30x60	0.15	3.30	ELM2NM152Q60KT	
	35x45	0.15	3.22	ELM2NM152R45KT	
	2200	35x50	0.15	3.63	ELM2NM182R50KT
2700	35x60	0.15	4.23	ELM2NM222R60KT	

Snap-in Lug Terminal Type

LM series

■ STANDARD RATINGS

WV (Vdc)	Cap (μF)	Size DxL(mm)	tan	Rated ripple current (Arms/105°C, 120Hz)	Part Number
250(2E)	120	22x20	0.15	0.60	ELM2EM121O20KT
	150	25x20	0.15	0.74	ELM2EM151P20KT
	180	22x25	0.15	0.78	ELM2EM181O25KT
		25x20	0.15	0.75	ELM2EM181P20KT
	220	22x25	0.15	1.00	ELM2EM221O25KT
		25x25	0.15	0.95	ELM2EM221P25KT
		30x20	0.15	0.95	ELM2EM221Q20KT
	270	22x30	0.15	1.18	ELM2EM271O30KT
		25x25	0.15	1.18	ELM2EM271P25KT
		30x20	0.15	1.00	ELM2EM271Q20KT
	330	22x35	0.15	1.30	ELM2EM331O35KT
		25x30	0.15	1.30	ELM2EM331P30KT
		30x25	0.15	1.30	ELM2EM331Q25KT
		35x20	0.15	1.16	ELM2EM331R20KT
	390	22x40	0.15	1.49	ELM2EM391O40KT
		25x35	0.15	1.49	ELM2EM391P35KT
		30x25	0.15	1.49	ELM2EM391Q25KT
	470	22x45	0.15	1.65	ELM2EM471O45KT
		25x35	0.15	1.65	ELM2EM471P35KT
		30x30	0.15	1.65	ELM2EM471Q30KT
		35x25	0.15	1.65	ELM2EM471R25KT
	560	22x50	0.15	1.67	ELM2EM561O50KT
		25x40	0.15	1.80	ELM2EM561P40KT
		30x30	0.15	1.80	ELM2EM561Q30KT
35x25		0.15	1.80	ELM2EM561R25KT	
680	25x50	0.15	2.00	ELM2EM681P50KT	
	30x35	0.15	2.00	ELM2EM681Q35KT	
	35x30	0.15	2.00	ELM2EM681R30KT	
820	25x60	0.15	2.20	ELM2EM821P60KT	
	30x40	0.15	2.30	ELM2EM821Q40KT	
	35x35	0.15	2.30	ELM2EM821R35KT	
1000	30x50	0.15	2.47	ELM2EM102R40KT	
	35x40	0.15	2.47	ELM2EM102R40KT	
1200	30x60	0.15	2.85	ELM2EM122Q60KT	
	35x45	0.15	2.60	ELM2EM122R45KT	
1500	35x50	0.15	3.00	ELM2EM152R50KT	
1800	35x60	0.15	3.42	ELM2EM182R60KT	
315(2F)	68	22x20	0.15	0.45	ELM2FM680O20KT
	82	22x20	0.15	0.47	ELM2FM820O20KT
	100	22x25	0.15	0.61	ELM2FM101O25KT
		25x20	0.15	0.56	ELM2FM101P20KT
	120	22x25	0.15	0.75	ELM2FM121O25KT
		25x20	0.15	0.62	ELM2FM121P20KT
	150	30x20	0.15	0.65	ELM2FM121Q20KT
		22x30	0.15	0.82	ELM2FM151O30KT
		25x25	0.15	0.82	ELM2FM151P25KT
	180	30x20	0.15	0.70	ELM2FM151Q20KT
		35x20	0.15	0.76	ELM2FM151R20KT
		22x35	0.15	0.92	ELM2FM181O35KT
	220	25x25	0.15	0.92	ELM2FM181P25KT
		30x25	0.15	0.90	ELM2FM181Q25KT
		35x20	0.15	0.85	ELM2FM181R20KT
	270	22x40	0.15	1.04	ELM2FM221O40KT
		25x30	0.15	1.04	ELM2FM221P30KT
		30x25	0.15	1.04	ELM2FM221Q25KT
	330	35x20	0.15	0.90	ELM2FM221R20KT
		22x45	0.15	1.16	ELM2FM271O45KT
		25x35	0.15	1.16	ELM2FM271P35KT
	390	30x25	0.15	1.16	ELM2FM271Q25KT
		35x25	0.15	1.15	ELM2FM271R25KT
		22x50	0.15	1.33	ELM2FM331O50KT
	470	25x40	0.15	1.33	ELM2FM331P40KT
		30x30	0.15	1.33	ELM2FM331Q30KT
		35x25	0.15	1.33	ELM2FM331R25KT
	560	25x45	0.15	1.47	ELM2FM391P45KT
		30x35	0.15	1.47	ELM2FM391Q35KT
		35x30	0.15	1.47	ELM2FM391R30KT
	680	25x50	0.15	1.70	ELM2FM471P50KT
		30x40	0.15	1.70	ELM2FM471Q40KT
		35x30	0.15	1.70	ELM2FM471R30KT
	820	30x45	0.15	2.05	ELM2FM561Q45KT
		35x35	0.15	2.05	ELM2FM561R35KT
		30x50	0.15	2.17	ELM2FM681Q50KT
	1000	35x40	0.15	2.17	ELM2FM681R40KT
		35x45	0.15	2.20	ELM2FM821R45KT
	1200	35x60	0.15	2.55	ELM2FM102R60KT

WV (Vdc)	Cap (μF)	Size DxL(mm)	tan	Rated ripple current (Arms/105°C, 120Hz)	Part Number
350(2V)	56	22x20	0.15	0.41	ELM2VM560O20KT
	68	25x20	0.15	0.46	ELM2VM680P20KT
	82	22x25	0.15	0.55	ELM2VM820O25KT
		25x20	0.15	0.51	ELM2VM820P20KT
	100	22x30	0.15	0.69	ELM2VM101O30KT
		30x20	0.15	0.60	ELM2VM101Q20KT
	120	22x30	0.15	0.75	ELM2VM121O30KT
		25x25	0.15	0.75	ELM2VM121P25KT
		30x20	0.15	0.65	ELM2VM121Q20KT
	150	22x35	0.15	0.82	ELM2VM151O35KT
		25x30	0.15	0.83	ELM2VM151P30KT
		30x25	0.15	0.82	ELM2VM151Q25KT
		35x20	0.15	0.76	ELM2VM151R20KT
	180	22x40	0.15	0.92	ELM2VM181O40KT
		25x30	0.15	0.92	ELM2VM181P30KT
		30x25	0.15	0.90	ELM2VM181Q25KT
	220	22x45	0.15	1.05	ELM2VM221O45KT
		25x35	0.15	1.04	ELM2VM221P35KT
		30x30	0.15	1.02	ELM2VM221Q30KT
		35x25	0.15	1.04	ELM2VM221R25KT
	270	22x50	0.15	1.16	ELM2VM271O50KT
		25x40	0.15	1.18	ELM2VM271P40KT
		30x30	0.15	1.17	ELM2VM271Q30KT
	330	35x25	0.15	1.20	ELM2VM271R25KT
25x45		0.15	1.29	ELM2VM331P45KT	
30x35		0.15	1.34	ELM2VM331Q35KT	
390	35x30	0.15	1.22	ELM2VM331R30KT	
	25x50	0.15	1.51	ELM2VM391P50KT	
	30x40	0.15	1.51	ELM2VM391Q40KT	
470	35x35	0.15	1.47	ELM2VM391R35KT	
	25x60	0.15	1.66	ELM2VM471P60KT	
	30x45	0.15	1.65	ELM2VM471Q45KT	
560	35x35	0.15	1.69	ELM2VM471R35KT	
	30x50	0.15	1.85	ELM2VM561Q50KT	
	35x40	0.15	1.90	ELM2VM561R40KT	
680	30x60	0.15	2.15	ELM2VM681Q60KT	
	35x50	0.15	1.99	ELM2VM681R50KT	
820	35x60	0.15	2.31	ELM2VM821R60KT	
400(2G)	47	22x20	0.15	0.37	ELM2GM470O20KT
	56	25x20	0.15	0.42	ELM2GM560P20KT
	68	22x25	0.15	0.50	ELM2GM680O25KT
		25x20	0.15	0.46	ELM2GM680P20KT
	82	22x25	0.15	0.64	ELM2GM820O25KT
		30x20	0.15	0.55	ELM2GM820Q20KT
	100	22x30	0.15	0.70	ELM2GM101O30KT
		25x25	0.15	0.70	ELM2GM101P25KT
		30x20	0.15	0.60	ELM2GM101Q20KT
	120	22x35	0.15	0.75	ELM2GM121O35KT
		25x25	0.15	0.75	ELM2GM121P25KT
		30x25	0.15	0.73	ELM2GM121Q25KT
	150	35x20	0.15	0.75	ELM2GM121R20KT
		22x40	0.15	0.88	ELM2GM151O40KT
		25x30	0.15	0.88	ELM2GM151P30KT
	180	30x25	0.15	0.88	ELM2GM151Q25KT
		35x20	0.15	0.80	ELM2GM151R20KT
		22x45	0.15	0.98	ELM2GM181O45KT
	220	25x35	0.15	0.98	ELM2GM181P35KT
		30x30	0.15	0.98	ELM2GM181Q30KT
		35x25	0.15	0.98	ELM2GM181R25KT
	270	22x50	0.15	1.10	ELM2GM221O50KT
		25x40	0.15	1.10	ELM2GM221P40KT
		30x30	0.15	1.10	ELM2GM221Q30KT
	330	35x25	0.15	1.10	ELM2GM221R25KT
		25x45	0.15	1.22	ELM2GM271P45KT
		30x35	0.15	1.22	ELM2GM271Q35KT
	390	35x30	0.15	1.22	ELM2GM271R30KT
		25x50	0.15	1.44	ELM2GM331P50KT
		30x40	0.15	1.44	ELM2GM331Q40KT
	470	35x30	0.15	1.44	ELM2GM331R30KT
		25x60	0.15	1.51	ELM2GM391P60KT
		30x45	0.15	1.60	ELM2GM391Q45KT
	560	35x35	0.15	1.60	ELM2GM391R35KT
		30x50	0.15	1.90	ELM2GM471Q50KT
		35x40	0.15	1.90	ELM2GM471R40KT
	680	30x60	0.15	2.10	ELM2GM561Q60KT
		35x45	0.15	2.12	ELM2GM561R45KT
	820	35x60	0.15	2.27	ELM2GM681R60KT

LM series

■ STANDARD RATINGS

WV (Vdc)	Cap (μF)	Size DxL(mm)	tan	Rated ripple current (Arms/105°C, 120Hz)	Part Number	
420(2T)	47	22x20	0.20	0.37	ELM2TM470O20KT	
	56	25x20	0.20	0.42	ELM2TM560P20KT	
	68	22x25	0.20	0.50	ELM2TM680O25KT	
		25x20	0.20	0.46	ELM2TM680P20KT	
	82	22x25	0.20	0.64	ELM2TM820O25KT	
		25x25	0.20	0.58	ELM2TM820P25KT	
		30x20	0.20	0.53	ELM2TM820Q20KT	
		22x30	0.20	0.70	ELM2TM101O30KT	
	100	25x25	0.20	0.70	ELM2TM101P25KT	
		30x20	0.20	0.59	ELM2TM101Q20KT	
	120	22x35	0.20	0.75	ELM2TM121O35KT	
		25x30	0.20	0.75	ELM2TM121P30KT	
		30x25	0.20	0.73	ELM2TM121Q25KT	
		35x20	0.20	0.67	ELM2TM121R20KT	
	150	22x40	0.20	0.88	ELM2TM151O40KT	
		25x35	0.20	0.88	ELM2TM151P35KT	
		30x25	0.20	0.88	ELM2TM151Q25KT	
	180	22x45	0.20	0.95	ELM2TM181O45KT	
		25x35	0.20	0.95	ELM2TM181P35KT	
		30x30	0.20	0.95	ELM2TM181Q30KT	
		35x25	0.20	0.94	ELM2TM181R25KT	
	220	22x50	0.20	1.10	ELM2TM221O50KT	
		25x45	0.20	1.10	ELM2TM221P45KT	
		30x35	0.20	1.10	ELM2TM221Q35KT	
		35x25	0.20	1.10	ELM2TM221R25KT	
	270	25x50	0.20	1.22	ELM2TM271P50KT	
		30x40	0.20	1.22	ELM2TM271Q40KT	
		35x30	0.20	1.22	ELM2TM271R30KT	
	330	25x60	0.20	1.41	ELM2TM331P60KT	
		30x45	0.20	1.45	ELM2TM331Q45KT	
		35x35	0.20	1.45	ELM2TM331R35KT	
	390	30x50	0.20	1.55	ELM2TM391Q50KT	
		35x40	0.20	1.55	ELM2TM391R40KT	
	470	30x60	0.20	1.79	ELM2TM471Q60KT	
		35x45	0.20	1.90	ELM2TM471R45KT	
	560	35x50	0.20	2.15	ELM2TM561R50KT	
	680	35x60	0.20	2.27	ELM2TM681R60KT	
	450(2W)	56	22x25	0.20	0.40	ELM2WM560O25KT
		68	22x30	0.20	0.53	ELM2WM680O30KT
			25x25	0.20	0.50	ELM2WM680P25KT
		82	22x30	0.20	0.64	ELM2WM820O30KT
			25x25	0.20	0.64	ELM2WM820P25KT
100		22x35	0.20	0.69	ELM2WM101O35KT	
		25x30	0.20	0.69	ELM2WM101P30KT	
120		30x25	0.20	0.64	ELM2WM101Q25KT	
		22x40	0.20	0.80	ELM2WM121O40KT	
		25x30	0.20	0.80	ELM2WM121P30KT	
		30x25	0.20	0.80	ELM2WM121Q25KT	
150		35x25	0.20	0.73	ELM2WM121R25KT	
		22x45	0.20	0.88	ELM2WM151O45KT	
		25x35	0.20	0.88	ELM2WM151P35KT	
		30x30	0.20	0.88	ELM2WM151Q30KT	
180		35x25	0.20	0.75	ELM2WM151R25KT	
		22x50	0.20	1.00	ELM2WM181O50KT	
		25x40	0.20	1.00	ELM2WM181P40KT	
220		30x30	0.20	1.00	ELM2WM181Q30KT	
		25x45	0.20	1.12	ELM2WM221P45KT	
		30x35	0.20	1.12	ELM2WM221Q35KT	
270		35x30	0.20	1.12	ELM2WM221R30KT	
		25x60	0.20	1.18	ELM2WM271P60KT	
		30x40	0.20	1.28	ELM2WM271Q40KT	
330		35x35	0.20	1.28	ELM2WM271R35KT	
		30x50	0.20	1.45	ELM2WM331Q50KT	
		35x40	0.20	1.45	ELM2WM331R40KT	
390		30x60	0.20	1.51	ELM2WM391Q60KT	
		35x40	0.20	1.55	ELM2WM391R40KT	
470		35x50	0.20	1.85	ELM2WM471R50KT	
560		35x60	0.20	1.91	ELM2WM561R60KT	

WV (Vdc)	Cap (μF)	Size DxL(mm)	tan	Rated ripple current (Arms/105°C, 120Hz)	Part Number	
500(2H)	47	22x25	0.20	0.51	ELM2HM470O25KT	
	56	22x30	0.20	0.58	ELM2HM560O30KT	
	68	22x25	0.20	0.65	ELM2HM680P25KT	
		25x25	0.20	0.72	ELM2HM820O35KT	
	82	22x35	0.20	0.74	ELM2HM820P30KT	
		25x30	0.20	0.74	ELM2HM820Q30KT	
	100	22x45	0.20	0.83	ELM2HM101O45KT	
		30x25	0.20	0.82	ELM2HM101Q25KT	
	120	22x50	0.20	0.93	ELM2HM121O50KT	
		25x35	0.20	0.93	ELM2HM121P35KT	
		30x30	0.20	0.91	ELM2HM121Q30KT	
		25x45	0.20	1.08	ELM2HM151P45KT	
	150	30x35	0.20	1.04	ELM2HM151Q35KT	
		35x25	0.20	0.99	ELM2HM151R25KT	
		25x50	0.20	1.20	ELM2HM181P50KT	
	180	30x40	0.20	1.17	ELM2HM181Q40KT	
		35x30	0.20	1.10	ELM2HM181R30KT	
	220	30x45	0.20	1.33	ELM2HM221Q45KT	
		35x35	0.20	1.23	ELM2HM221R35KT	
	270	30x50	0.20	1.50	ELM2HM271O50KT	
		35x40	0.20	1.42	ELM2HM271R40KT	
	330	35x45	0.20	1.60	ELM2HM331R45KT	
	390	35x50	0.20	1.78	ELM2HM391R50KT	
	470	35x60	0.20	2.03	ELM2HM471R60KT	
	550(2J)	82	22x35	0.20	0.72	ELM2JM820O35KT
			25x30	0.20	0.74	ELM2JM820P30KT
		100	22x45	0.20	0.83	ELM2JM101O45KT
			25x35	0.20	0.85	ELM2JM101P35KT
			30x25	0.20	0.82	ELM2JM101Q25KT
		120	22x50	0.20	0.93	ELM2JM121O50KT
			25x40	0.20	0.95	ELM2JM121P40KT
			30x30	0.20	0.91	ELM2JM121Q30KT
		150	35x25	0.20	0.88	ELM2JM121R25KT
			25x45	0.20	1.08	ELM2JM151P45KT
			30x35	0.20	1.04	ELM2JM151Q35KT
			25x50	0.20	1.20	ELM2JM181P50KT
		180	30x40	0.20	1.17	ELM2JM181Q40KT
			35x30	0.20	1.10	ELM2JM181R30KT
		220	30x45	0.20	1.33	ELM2JM221Q45KT
			35x35	0.20	1.23	ELM2JM221R35KT
			30x50	0.20	1.50	ELM2JM271Q50KT
		270	35x40	0.20	1.42	ELM2JM271R40KT
330			35x45	0.20	1.60	ELM2JM331R45KT
390		35x50	0.20	1.64	ELM2JM391R50KT	
470		35x60	0.20	2.03	ELM2JM471R60KT	

Snap-in&Lug Terminal Type

LP series

- Longer life, high ripple current series
- Endurance: 3,000 hours at 105°C
- RoHS Compliant



SPECIFICATIONS

Items	Characteristics		
Category Temperature Range	-40~+105°C		
Rated Voltage Range	400~450V.DC		
Capacitance Tolerance	±20%(M) (at 20°C, 120Hz)		
Leakage Current	$I \leq 3\sqrt{CV}$ Where, I:Max.leakage current (μA), C:Nominal capacitance (μF), V: Rated voltage (V) (at 20°C after 5 minutes)		
Dissipation Factor (tan δ)	Rated Voltage(V _{dc})	400	420,450
	tan δ (max.)	0.15	0.20
Low Temperature Characteristics (Max. Impedance Ratio)	Rated Voltage(V _{dc})	400~450	
	Z(-25°C)/Z(+20°C)	6	
	Z(-40°C)/Z(+20°C)	8	
Endurance	The following specifications shall be satisfied when the capacitors are restored to 20°C after DC voltage plus the rated ripple current is applied for 3,000 hours at 105°C.		
	Capacitance Change	±20% of the initial value	
	D.F. (tan δ)	200% of the initial specified value	
	Leakage Current	The initial specified value	
Shelf Life	The following specifications shall be satisfied when the capacitors are restored to 20°C after exposing them for 1,000 hours at 105°C without voltage applied.		
	Capacitance Change	±15% of the initial value	
	D.F. (tan δ)	150% of the initial specified value	
	Leakage Current	200% of the initial specified value	

DIMENSIONS[mm]

- Terminal Code : K (22 to 35) : Standard

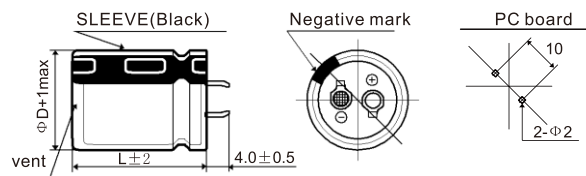

- Terminal Code : L (35)

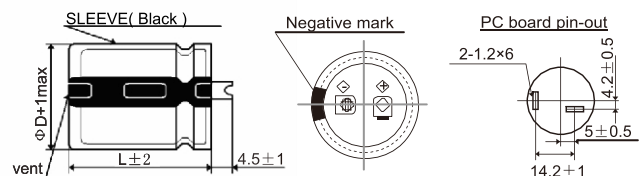

PART NUMBERING SYSTEM

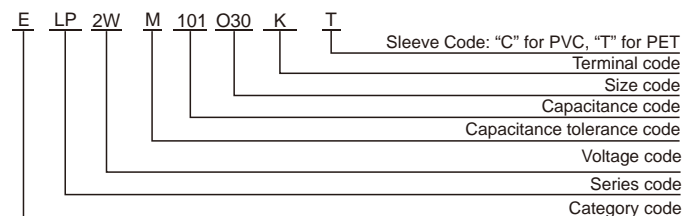

RATED RIPPLE CURRENT MULTIPLIERS

Frequency correction factor for ripple current

Rated voltage(V _{dc})	Freq.(Hz)			
	120	1k	10k	100k
400~450	1.00	1.30	1.41	1.43

The endurance of capacitors is shortened with internal heating produced by ripple current at the rate of halving the lifetime with every 5°C rise. When long life performance is required in actual use, the rms ripple current has to be reduced.

LP series

■ STANDARD RATINGS

WV (Vdc)	Cap (μF)	Size DxL(mm)	tan	Rated ripple current (Arms/105°C, 120Hz)	Part Number	
400(2G)	100	22x25	0.15	0.85	ELP2GM101O25KT	
	120	22x30	0.15	1.01	ELP2GM121O30KT	
		25x25	0.15	1.04	ELP2GM121P25KT	
	150	22x35	0.15	1.15	ELP2GM151O35KT	
		180	22x40	0.15	1.27	ELP2GM181O40KT
	25x30		0.15	1.22	ELP2GM181P30KT	
	180	30x25	0.15	1.35	ELP2GM181Q25KT	
		220	22x45	0.15	1.40	ELP2GM221O45KT
			25x35	0.15	1.40	ELP2GM221P35KT
	220	30x30	0.15	1.56	ELP2GM221Q30KT	
		270	22x50	0.15	1.55	ELP2GM271O50KT
			25x40	0.15	1.55	ELP2GM271P40KT
	270	30x35	0.15	1.78	ELP2GM271Q35KT	
		35x25	0.15	1.78	ELP2GM271R25KT	
		330	25x50	0.15	1.83	ELP2GM331P50KT
	30x40		0.15	2.00	ELP2GM331Q40KT	
	35x30		0.15	1.95	ELP2GM331R30KT	
	390	30x45	0.15	2.20	ELP2GM391Q45KT	
		35x35	0.15	2.20	ELP2GM391R35KT	
	470	30x50	0.15	2.38	ELP2GM471Q50KT	
35x40		0.15	2.49	ELP2GM471R40KT		
560	35x45	0.15	2.74	ELP2GM561R45KT		
680	35x50	0.15	2.95	ELP2GM681R50KT		
420(2T)	100	22x25	0.20	0.89	ELP2TM101O25KT	
	120	22x30	0.20	1.06	ELP2TM121O30KT	
		25x25	0.20	1.09	ELP2TM121P25KT	
	150	22x35	0.20	1.21	ELP2TM151O35KT	
		180	22x40	0.20	1.34	ELP2TM181O40KT
	25x30		0.20	1.28	ELP2TM181P30KT	
	180	30x25	0.20	1.42	ELP2TM181Q25KT	
		220	22x45	0.20	1.47	ELP2TM221O45KT
			22x50	0.20	1.60	ELP2TM221O50KT
	220	25x35	0.20	1.47	ELP2TM221P35KT	
		30x30	0.20	1.64	ELP2TM221Q30KT	
		35x25	0.20	1.64	ELP2TM221R25KT	
	270	25x40	0.20	1.63	ELP2TM271P40KT	
		25x45	0.20	1.79	ELP2TM271P45KT	
		30x35	0.20	1.87	ELP2TM271Q35KT	
	330	25x50	0.20	1.93	ELP2TM331P50KT	
		30x40	0.20	2.10	ELP2TM331Q40KT	
		35x30	0.20	2.05	ELP2TM331R30KT	
	390	30x45	0.20	2.32	ELP2TM391Q45KT	
		35x35	0.20	2.32	ELP2TM391R35KT	
470	30x50	0.20	2.51	ELP2TM471Q50KT		
	35x40	0.20	2.62	ELP2TM471R40KT		
560	35x45	0.20	2.88	ELP2TM561R45KT		
680	35x50	0.20	3.10	ELP2TM681R50KT		
820	35x60	0.20	3.50	ELP2TM821R60KT		

WV (Vdc)	Cap (μF)	Size DxL(mm)	tan	Rated ripple current (Arms/105°C, 120Hz)	Part Number	
450(2W)	82	22x25	0.20	0.81	ELP2WM820O25KT	
	100	22x30	0.20	0.97	ELP2WM101O30KT	
		25x25	0.20	1.04	ELP2WM101P25KT	
	120	22x35	0.20	1.08	ELP2WM121O35KT	
		150	22x40	0.20	1.22	ELP2WM151O40KT
	25x35		0.20	1.31	ELP2WM151P35KT	
	150	30x25	0.20	1.31	ELP2WM151Q25KT	
		180	22x45	0.20	1.35	ELP2WM181O45KT
			22x50	0.20	1.42	ELP2WM181O50KT
	180	25x40	0.20	1.35	ELP2WM181P40KT	
		30x30	0.20	1.49	ELP2WM181Q30KT	
		35x25	0.20	1.60	ELP2WM181R25KT	
	220	25x45	0.20	1.55	ELP2WM221P45KT	
		30x35	0.20	1.71	ELP2WM221Q35KT	
		270	25x50	0.20	1.74	ELP2WM271P50KT
	30x40		0.20	1.90	ELP2WM271Q40KT	
	35x30		0.20	1.90	ELP2WM271R30KT	
	330	30x45	0.20	2.20	ELP2WM331Q45KT	
		35x35	0.20	2.20	ELP2WM331R35KT	
	390	30x50	0.20	2.40	ELP2WM391Q50KT	
35x40		0.20	2.42	ELP2WM391R40KT		
470	35x45	0.20	2.67	ELP2WM471R45KT		
560	35x50	0.20	2.85	ELP2WM561R50KT		
680	35x60	0.20	3.15	ELP2WM681R60KT		
820	35x70	0.20	3.48	ELP2WM821R70KT		

Snap-in&Lug Terminal Type

LQ series

- Longer life series
- Endurance: 5,000 hours at 85°C
- Non solvent-proof type
- **RoHS Compliant**



SPECIFICATIONS

Items	Characteristics		
Category Temperature Range	-25~+85°C		
Rated Voltage Range	160~450V.DC		
Capacitance Tolerance	±20%(M) (at 20°C,120Hz)		
Leakage Current	$I \leq 3\sqrt{CV}$ Where, I:Max.leakage current (µA),C:Nominal capacitance (µF),V: Rated voltage (V) (at 20°C after 5 minutes)		
Dissipation Factor (tan δ)	Rated Voltage(V _{dc})	160~400	420~450
	tan δ (max.)	0.15	0.20
Low Temperature Characteristics (Max. Impedance Ratio)	Rated Voltage(V _{dc})	160~400	420~450
	Z(-25°C)/Z(+20°C)	4	8
Endurance	The following specifications shall be satisfied when the capacitors are restored to 20°C after DC voltage plus the rated ripple current is applied for 5,000 hours at 85 °C.		
	Capacitance Change	±20% of the initial value	
	D.F. (tan δ)	200% of the initial specified value	
	Leakage Current	The initial specified value	
Shelf Life	The following specifications shall be satisfied when the capacitors are restored to 20°C after exposing them for 1,000 hours at 85°C without voltage applied.		
	Capacitance Change	±15% of the initial value	
	D.F. (tan δ)	150% of the initial specified value	
	Leakage Current	The initial specified value	

DIMENSIONS[mm]

- Terminal Code : K (22 to 35) : Standard

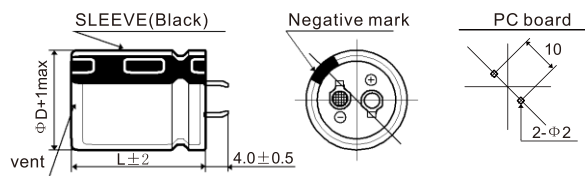

- Terminal Code : L (35)

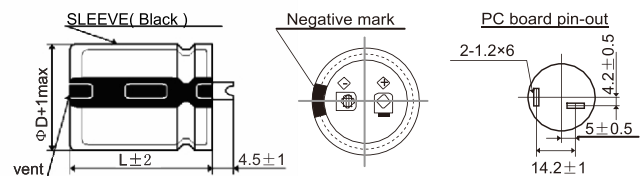

PART NUMBERING SYSTEM

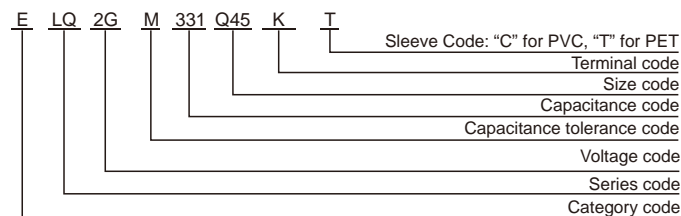

RATED RIPPLE CURRENT MULTIPLIERS

Frequency correction factor for ripple current

Rated voltage(V _{dc}) \ Freq.(Hz)	120	1k	10k	100k
160~250	1.00	1.32	1.45	1.50
315~450	1.00	1.30	1.41	1.43

The endurance of capacitors is shortened with internal heating produced by ripple current at the rate of halving the lifetime with every 5°C rise. When long life performance is required in actual use, the rms ripple current has to be reduced.

LQ series

■ STANDARD RATINGS

WV (Vdc)	Cap (μF)	Size DxL(mm)	tan	Rated ripple current (Arms/85°C, 120Hz)	Part Number
160(2C)	220	22x25	0.15	1.00	ELQ2CM221O25KT
	270	22x25	0.15	1.10	ELQ2CM271O25KT
	330	22x25	0.15	1.30	ELQ2CM331O25KT
	390	22x30	0.15	1.50	ELQ2CM391O30KT
		25x25	0.15	1.51	ELQ2CM391P25KT
	470	22x30	0.15	1.65	ELQ2CM471O30KT
		25x25	0.15	1.70	ELQ2CM471P25KT
	560	22x35	0.15	1.91	ELQ2CM561O35KT
		25x30	0.15	1.90	ELQ2CM561P30KT
		30x25	0.15	2.01	ELQ2CM561Q25KT
	680	22x40	0.15	2.10	ELQ2CM681O40KT
		25x35	0.15	2.20	ELQ2CM681P35KT
		30x30	0.15	2.22	ELQ2CM681Q30KT
	820	22x50	0.15	2.48	ELQ2CM821O50KT
		25x40	0.15	2.43	ELQ2CM821P40KT
		30x30	0.15	2.49	ELQ2CM821Q30KT
		35x25	0.15	2.45	ELQ2CM821R25KT
	1000	25x45	0.15	2.69	ELQ2CM102P45KT
		30x35	0.15	2.79	ELQ2CM102Q35KT
		35x30	0.15	2.71	ELQ2CM102R30KT
	1200	25x50	0.15	3.09	ELQ2CM122P50KT
		30x40	0.15	3.11	ELQ2CM122Q40KT
35x35		0.15	3.05	ELQ2CM122R35KT	
1500	30x45	0.15	3.68	ELQ2CM152Q45KT	
	35x40	0.15	3.51	ELQ2CM152R40KT	
1800	35x45	0.15	3.88	ELQ2CM182R45KT	
2200	35x50	0.15	4.52	ELQ2CM222R50KT	
180(2L)	270	22x25	0.15	1.19	ELQ2LM271O25KT
	330	22x30	0.15	1.38	ELQ2LM331O30KT
	390	22x30	0.15	1.45	ELQ2LM391O30KT
		25x25	0.15	1.49	ELQ2LM391P25KT
	470	22x35	0.15	1.68	ELQ2LM471O35KT
		25x30	0.15	2.69	ELQ2LM471P30KT
	560	30x25	0.15	1.81	ELQ2LM471Q25KT
		22x40	0.15	1.89	ELQ2LM561O40KT
		25x35	0.15	2.01	ELQ2LM561P35KT
	680	30x30	0.15	2.10	ELQ2LM561Q30KT
		22x50	0.15	2.29	ELQ2LM681O50KT
		25x40	0.15	2.21	ELQ2LM681P40KT
	820	30x30	0.15	2.31	ELQ2LM681Q30KT
		35x25	0.15	2.22	ELQ2LM681R25KT
		25x45	0.15	2.51	ELQ2LM821P45KT
	1000	30x35	0.15	2.60	ELQ2LM821Q35KT
		35x30	0.15	2.66	ELQ2LM821R30KT
		25x50	0.15	2.91	ELQ2LM102P50KT
	1200	30x40	0.15	2.90	ELQ2LM102Q40KT
		35x35	0.15	2.94	ELQ2LM102R35KT
	1500	30x45	0.15	3.29	ELQ2LM122Q45KT
		35x35	0.15	3.19	ELQ2LM122R35KT
1800	35x45	0.15	3.60	ELQ2LM152R45KT	
1800	35x50	0.15	4.11	ELQ2LM182R50KT	

WV (Vdc)	Cap (μF)	Size DxL(mm)	tan	Rated ripple current (Arms/85°C, 120Hz)	Part Number
200(2D)	220	22x25	0.15	1.11	ELQ2DM221O25KT
	270	22x25	0.15	1.21	ELQ2DM271O25KT
	330	22x30	0.15	1.41	ELQ2DM331O30KT
		25x25	0.15	1.40	ELQ2DM331P25KT
	390	22x35	0.15	1.59	ELQ2DM391O35KT
		25x30	0.15	1.61	ELQ2DM391P30KT
	470	22x40	0.15	1.78	ELQ2DM471O40KT
		25x35	0.15	1.85	ELQ2DM471P35KT
		30x25	0.15	1.88	ELQ2DM471Q25KT
	560	22x45	0.15	2.11	ELQ2DM561O45KT
		25x35	0.15	2.13	ELQ2DM561P35KT
		30x30	0.15	2.10	ELQ2DM561Q30KT
		35x25	0.15	2.05	ELQ2DM561R25KT
	680	25x40	0.15	2.33	ELQ2DM681P40KT
		30x35	0.15	2.40	ELQ2DM681Q35KT
		35x30	0.15	2.48	ELQ2DM681R30KT
	820	25x50	0.15	2.59	ELQ2DM821P50KT
		30x40	0.15	2.78	ELQ2DM821Q40KT
		35x30	0.15	2.59	ELQ2DM821R30KT
	1000	30x45	0.15	3.06	ELQ2DM102Q45KT
		35x35	0.15	2.80	ELQ2DM102R35KT
	1200	30x50	0.15	3.41	ELQ2DM122Q50KT
35x40		0.15	3.18	ELQ2DM122R40KT	
1500	35x50	0.15	3.80	ELQ2DM152R50KT	
220(2N)	180	22x25	0.15	1.06	ELQ2NM181O25KT
	220	22x25	0.15	1.10	ELQ2NM221O25KT
	270	22x30	0.15	1.19	ELQ2NM271O30KT
		25x25	0.15	1.20	ELQ2NM271P25KT
	330	22x35	0.15	1.40	ELQ2NM331O35KT
		25x30	0.15	1.42	ELQ2NM331P30KT
		30x25	0.15	1.42	ELQ2NM331Q25KT
	390	22x40	0.15	1.57	ELQ2NM391O40KT
		25x35	0.15	1.58	ELQ2NM391P35KT
		30x30	0.15	1.55	ELQ2NM391Q30KT
	470	22x45	0.15	1.77	ELQ2NM471O45KT
		25x40	0.15	1.79	ELQ2NM471P40KT
		30x30	0.15	1.81	ELQ2NM471Q30KT
	560	22x50	0.15	2.12	ELQ2NM561O50KT
		25x45	0.15	2.22	ELQ2NM561P45KT
		30x35	0.15	2.28	ELQ2NM561Q35KT
		35x30	0.15	2.26	ELQ2NM561R30KT
	680	25x50	0.15	2.35	ELQ2NM681P50KT
		30x40	0.15	2.30	ELQ2NM681Q40KT
		35x30	0.15	2.36	ELQ2NM681R30KT
	820	30x45	0.15	2.81	ELQ2NM821Q45KT
		35x35	0.15	2.79	ELQ2NM821R35KT
1000	30x50	0.15	3.12	ELQ2NM102Q50KT	
	35x40	0.15	3.29	ELQ2NM102R40KT	
1200	35x45	0.15	3.40	ELQ2NM122R45KT	
1500	35x50	0.15	3.86	ELQ2NM152R50KT	

Snap-in&Lug Terminal Type

LQ series

■ STANDARD RATINGS

WV (Vdc)	Cap (μF)	Size DxL(mm)	tan	Rated ripple current (Arms/85°C, 120Hz)	Part Number
250(2E)	180	22x25	0.15	0.94	ELQ2EM181O25KT
	220	22x30	0.15	1.09	ELQ2EM221O30KT
		25x25	0.15	1.10	ELQ2EM221P25KT
		22x35	0.15	1.19	ELQ2EM271O35KT
	270	25x30	0.15	1.21	ELQ2EM271P30KT
		22x40	0.15	1.38	ELQ2EM331O40KT
		25x30	0.15	1.39	ELQ2EM331P30KT
	330	30x25	0.15	1.48	ELQ2EM331Q25KT
		22x45	0.15	1.61	ELQ2EM391O45KT
		25x35	0.15	1.60	ELQ2EM391P35KT
	390	30x30	0.15	1.63	ELQ2EM391Q30KT
		22x50	0.15	1.79	ELQ2EM471O50KT
		25x40	0.15	1.78	ELQ2EM471P40KT
	470	30x30	0.15	1.81	ELQ2EM471Q30KT
		25x45	0.15	2.01	ELQ2EM561P45KT
	560	30x35	0.15	2.10	ELQ2EM561Q35KT
30x40		0.15	2.25	ELQ2EM681Q40KT	
680	35x35	0.15	2.39	ELQ2EM681R35KT	
	30x45	0.15	2.61	ELQ2EM821Q45KT	
820	35x40	0.15	2.59	ELQ2EM821R40KT	
	1000	35x45	0.15	2.87	ELQ2EM102R45KT
1200	35x50	0.15	3.32	ELQ2EM122R50KT	
315(2F)	100	22x25	0.15	0.79	ELQ2FM101O25KT
	120	22x30	0.15	0.90	ELQ2FM121O30KT
	150	22x30	0.15	1.06	ELQ2FM151O30KT
		25x25	0.15	1.00	ELQ2FM151P25KT
	180	22x35	0.15	1.29	ELQ2FM181O35KT
		25x30	0.15	1.32	ELQ2FM181P30KT
	220	22x40	0.15	1.41	ELQ2FM221O40KT
		25x35	0.15	1.45	ELQ2FM221P35KT
		30x25	0.15	1.28	ELQ2FM221Q25KT
	270	22x45	0.15	1.68	ELQ2FM271O45KT
		25x40	0.15	1.62	ELQ2FM271P40KT
		30x30	0.15	1.55	ELQ2FM271Q30KT
	330	35x25	0.15	1.43	ELQ2FM271R25KT
		25x45	0.15	1.94	ELQ2FM331P45KT
		30x35	0.15	1.98	ELQ2FM331Q35KT
	390	35x30	0.15	1.91	ELQ2FM331R30KT
		25x50	0.15	2.11	ELQ2FM391P50KT
		30x40	0.15	2.15	ELQ2FM391Q40KT
	470	35x30	0.15	1.95	ELQ2FM391R30KT
		30x45	0.15	2.38	ELQ2FM471Q45KT
	560	35x35	0.15	2.46	ELQ2FM471R35KT
		30x50	0.15	2.63	ELQ2FM561Q50KT
	680	35x40	0.15	2.69	ELQ2FM561R40KT
		35x45	0.15	3.05	ELQ2FM681R45KT

WV (Vdc)	Cap (μF)	Size DxL(mm)	tan	Rated ripple current (Arms/85°C, 120Hz)	Part Number
350(2V)	82	22x25	0.15	0.64	ELQ2VM820O25KT
	100	22x25	0.15	0.86	ELQ2VM101O25KT
	120	22x30	0.15	1.04	ELQ2VM121O30KT
		25x25	0.15	0.90	ELQ2VM121P25KT
	150	22x35	0.15	1.20	ELQ2VM151O35KT
		25x30	0.15	1.22	ELQ2VM151P30KT
	180	22x40	0.15	1.34	ELQ2VM181O40KT
		25x30	0.15	1.37	ELQ2VM181P30KT
	220	22x45	0.15	1.47	ELQ2VM221O45KT
		25x35	0.15	1.53	ELQ2VM221P35KT
		30x30	0.15	1.54	ELQ2VM221Q30KT
	270	35x25	0.15	1.29	ELQ2VM221R25KT
		25x45	0.15	1.73	ELQ2VM271P45KT
		30x35	0.15	1.80	ELQ2VM271Q35KT
	330	35x30	0.15	1.49	ELQ2VM271R30KT
		25x50	0.15	1.97	ELQ2VM331P50KT
30x40		0.15	2.03	ELQ2VM331Q40KT	
390	35x30	0.15	1.80	ELQ2VM331R30KT	
	30x40	0.15	2.23	ELQ2VM391Q40KT	
	35x35	0.15	2.30	ELQ2VM391R35KT	
470	30x45	0.15	2.53	ELQ2VM471Q45KT	
	35x40	0.15	2.55	ELQ2VM471R40KT	
560	35x45	0.15	2.75	ELQ2VM561R45KT	
680	35x50	0.15	3.15	ELQ2VM681R50KT	
400(2G)	68	22x25	0.15	0.65	ELQ2GM680O25KT
	82	22x25	0.15	0.84	ELQ2GM820O25KT
	100	22x30	0.15	0.99	ELQ2GM101O30KT
		25x25	0.15	0.82	ELQ2GM101P25KT
	120	22x35	0.15	1.09	ELQ2GM121O35KT
		25x30	0.15	1.13	ELQ2GM121P30KT
	150	22x40	0.15	1.24	ELQ2GM151O40KT
		25x30	0.15	1.27	ELQ2GM151P30KT
		30x25	0.15	1.20	ELQ2GM151Q25KT
	180	22x45	0.15	1.41	ELQ2GM181O45KT
		25x35	0.15	1.44	ELQ2GM181P35KT
		30x30	0.15	1.52	ELQ2GM181Q30KT
	220	35x25	0.15	1.16	ELQ2GM181R25KT
		22x50	0.15	1.58	ELQ2GM221O50KT
		25x40	0.15	1.64	ELQ2GM221P40KT
	270	30x35	0.15	1.66	ELQ2GM221Q35KT
		35x30	0.15	1.47	ELQ2GM221R30KT
		25x45	0.15	1.79	ELQ2GM271P45KT
	330	30x40	0.15	1.82	ELQ2GM271Q40KT
		35x30	0.15	1.63	ELQ2GM271R30KT
		30x45	0.15	2.05	ELQ2GM331Q45KT
	390	35x35	0.15	2.05	ELQ2GM331R35KT
		30x50	0.15	2.26	ELQ2GM391Q50KT
		35x40	0.15	2.28	ELQ2GM391R40KT
470	35x45	0.15	2.54	ELQ2GM471R45KT	
560	35x50	0.15	2.85	ELQ2GM561R50KT	

LQ series

■ STANDARD RATINGS

WV (V _{dc})	Cap (μF)	Size DxL(mm)	tan	Rated ripple current (Arms/85°C, 120Hz)	Part Number
420(2T)	100	22x30	0.20	0.97	ELQ2TM101O30KT
		25x25	0.20	0.98	ELQ2TM101P25KT
	120	22x30	0.20	1.07	ELQ2TM121O30KT
		25x30	0.20	1.08	ELQ2TM121P30KT
	150	22x40	0.20	1.21	ELQ2TM151O40KT
		25x35	0.20	1.26	ELQ2TM151P35KT
	180	25x35	0.20	1.42	ELQ2TM181P35KT
		30x30	0.20	1.48	ELQ2TM181Q30KT
	220	25x40	0.20	1.58	ELQ2TM221P40KT
		30x35	0.20	1.65	ELQ2TM221Q35KT
	270	30x35	0.20	1.90	ELQ2TM271Q35KT
		35x30	0.20	1.94	ELQ2TM271R30KT
	330	35x35	0.20	2.17	ELQ2TM331R35KT
	390	30x50	0.20	2.22	ELQ2TM391Q50KT
		35x45	0.20	2.23	ELQ2TM391R45KT
560	35x50	0.20	2.93	ELQ2TM561R50KT	
450(2W)	68	22x30	0.20	0.71	ELQ2WM680O30KT
	82	22x35	0.20	0.86	ELQ2WM820O35KT
	100	22x35	0.20	0.95	ELQ2WM101O35KT
		25x30	0.20	0.97	ELQ2WM101P30KT
	120	22x40	0.20	1.07	ELQ2WM121O40KT
		25x35	0.20	1.09	ELQ2WM121P35KT
	150	22x50	0.20	1.18	ELQ2WM151O50KT
		25x40	0.20	1.25	ELQ2WM151P40KT
		30x30	0.20	1.29	ELQ2WM151Q30KT
	180	25x45	0.20	1.40	ELQ2WM181P45KT
		30x35	0.20	1.45	ELQ2WM181Q35KT
		35x25	0.20	1.30	ELQ2WM181R25KT
	220	25x50	0.20	1.59	ELQ2WM221P50KT
		30x40	0.20	1.64	ELQ2WM221Q40KT
		35x30	0.20	1.60	ELQ2WM221R30KT
	270	30x45	0.20	1.88	ELQ2WM271Q45KT
		35x35	0.20	1.89	ELQ2WM271R35KT
	330	30x50	0.20	2.12	ELQ2WM331Q50KT
		35x40	0.20	2.15	ELQ2WM331R40KT
	390	35x45	0.20	2.35	ELQ2WM391R45KT
	470	35x50	0.20	2.65	ELQ2WM471R50KT

Snap-in&Lug Terminal Type

LG series

- Longer life, high ripple current series
- Endurance: 12,000 hours at 85°C
- RoHS Compliant



SPECIFICATIONS

Items	Characteristics	
Category Temperature Range	-25~+85°C	
Rated Voltage Range	350~450V.DC	
Capacitance Tolerance	±20%(M) (at 20°C,120Hz)	
Leakage Current	$I \leq 3\sqrt{CV}$ Where, I:Max.leakage current (µA),C:Nominal capacitance (µF),V: Rated voltage (V) (at 20°C after 5 minutes)	
Dissipation Factor (tan)	Rated Voltage(V _{dc})	350~450
	tan (max.)	0.20 (at 20°C,120Hz)
Low Temperature Characteristics (Max. Impedance Ratio)	Rated Voltage(V _{dc})	350~450
	Z(-25°C)/Z(+20°C)	8 (at 120Hz)
Endurance	The following specifications shall be satisfied when the capacitors are restored to 20°C after DC voltage plus the rated ripple current is applied for 12,000 hours at 85 °C.	
	Capacitance Change	±20% of the initial value
	D.F. (tan)	200% of the initial specified value
	Leakage Current	The initial specified value
Shelf Life	The following specifications shall be satisfied when the capacitors are restored to 20°C after exposing them for 1,000 hours at 85°C without voltage applied.	
	Capacitance Change	±15% of the initial value
	D.F. (tan)	150% of the initial specified value
	Leakage Current	200% of the initial specified value

DIMENSIONS[mm]

- Terminal Code: K (35)

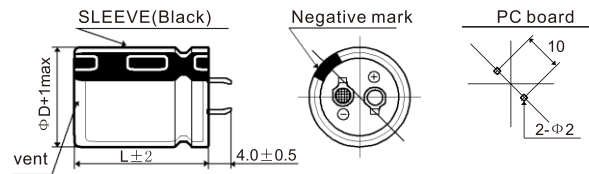

- Terminal Code: P (35 to 45)

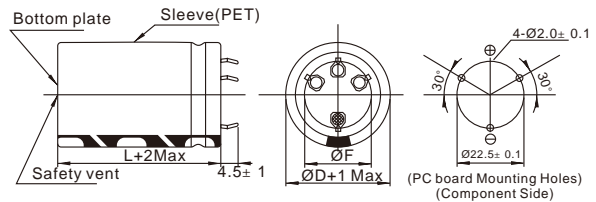

PART NUMBERING SYSTEM

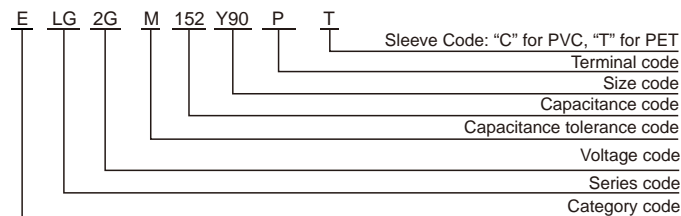

RATED RIPPLE CURRENT MULTIPLIERS

Frequency correction factor for ripple current

Rated voltage(V _{dc}) \ Freq.(Hz)	50	120	300	1k	10k	100k
350~450	0.77	1.00	1.16	1.30	1.41	1.43

The endurance of capacitors is shortened with internal heating produced by ripple current at the rate of halving the lifetime with every 5°C rise. When long life performance is required in actual use, the rms ripple current has to be reduced.

LG series

■ STANDARD RATINGS

WV (V _{dc})	Cap (μF)	Size D×L(mm)	tan	Rated ripple current (Arms/85°C, 120Hz)	Part Number
350(2V)	680	35×50	0.20	3.62	ELG2VM681R50KT
	820	35×55	0.20	3.97	ELG2VM821R55KT
		40×50	0.20	4.08	ELG2VM821Y50PT
	1000	35×65	0.20	4.54	ELG2VM102R65KT
		40×55	0.20	4.46	ELG2VM102Y55PT
	1200	35×75	0.20	5.09	ELG2VM122R75PT
		40×60	0.20	4.82	ELG2VM122Y60PT
		45×50	0.20	4.43	ELG2VM122I50PT
	1500	35×95	0.20	5.98	ELG2VM152R95PT
		40×70	0.20	5.47	ELG2VM152Y70PT
		45×60	0.20	5.20	ELG2VM152I60PT
	1800	40×90	0.20	6.51	ELG2VM182Y90PT
		45×65	0.20	5.53	ELG2VM182I65PT
	2200	45×85	0.20	6.73	ELG2VM222I85PT
2700	45×100	0.20	7.62	ELG2VM272IA0PT	
400(2G)	560	35×50	0.20	3.45	ELG2GM561R50KT
	680	35×60	0.20	3.98	ELG2GM681R60KT
		40×50	0.20	3.90	ELG2GM681Y50PT
		35×65	0.20	4.32	ELG2GM821R65KT
	820	40×55	0.20	4.25	ELG2GM821Y55PT
		45×50	0.20	4.27	ELG2GM821I50PT
		35×80	0.20	5.02	ELG2GM102R80PT
	1000	40×65	0.20	4.88	ELG2GM102Y65PT
		45×55	0.20	4.64	ELG2GM102I55PT
		35×90	0.20	5.54	ELG2GM122R90PT
	1200	40×75	0.20	5.47	ELG2GM122Y75PT
		45×60	0.20	4.99	ELG2GM122I60PT
		40×90	0.20	6.30	ELG2GM152Y90PT
	1500	45×70	0.20	5.65	ELG2GM152I70PT
		1800	45×80	0.20	6.28
	2200	45×95	0.20	7.18	ELG2GM222I95PT

WV (V _{dc})	Cap (μF)	Size D×L(mm)	tan	Rated ripple current (Arms/85°C, 120Hz)	Part Number
420(2T)	560	35×50	0.20	3.39	ELG2TM561R50KT
	680	35×60	0.20	3.92	ELG2TM681R60KT
		40×50	0.20	3.85	ELG2TM681Y50PT
	820	35×65	0.20	4.26	ELG2TM821R65KT
		40×55	0.20	4.21	ELG2TM821Y55PT
	1000	35×80	0.20	4.94	ELG2TM102R80PT
		40×65	0.20	4.82	ELG2TM102Y65PT
		45×50	0.20	4.23	ELG2TM102I50PT
	1200	35×95	0.20	5.58	ELG2TM122R95PT
		40×75	0.20	5.42	ELG2TM122Y75PT
		45×60	0.20	4.97	ELG2TM122I60PT
	1500	40×90	0.20	6.19	ELG2TM152Y90PT
		45×70	0.20	5.63	ELG2TM152I70PT
	1800	45×85	0.20	6.50	ELG2TM182I85PT
2200	45×100	0.20	7.36	ELG2TM222IA0PT	
450(2W)	470	35×50	0.20	3.25	ELG2WM471R50KT
	560	35×55	0.20	3.56	ELG2WM561R55KT
		40×50	0.20	3.70	ELG2WM561Y50PT
	680	35×65	0.20	4.07	ELG2WM681R65KT
		40×55	0.20	4.06	ELG2WM681Y55PT
	820	35×75	0.20	4.55	ELG2WM821R75PT
		40×60	0.20	4.41	ELG2WM821Y60PT
		45×50	0.20	4.14	ELG2WM821I50PT
	1000	35×85	0.20	5.07	ELG2WM102R85PT
		40×70	0.20	5.00	ELG2WM102Y70PT
		45×60	0.20	4.84	ELG2WM102I60PT
	1200	35×100	0.20	5.71	ELG2WM122RA0PT
		40×80	0.20	5.57	ELG2WM122Y80PT
		45×65	0.20	5.18	ELG2WM122I65PT
	1500	40×95	0.20	6.36	ELG2WM152Y95PT
		45×80	0.20	6.13	ELG2WM152I80PT
	1800	45×90	0.20	6.71	ELG2WM182I90PT

LT series

- Downsized and long life series
- Endurance: 5,000 hours at 105°C
- RoHS Compliant



SPECIFICATIONS

Items	Characteristics			
Category Temperature Range	-25~+105°C			
Rated Voltage Range	160~550V.DC			
Capacitance Tolerance	±20%(M) (at 20°C, 120Hz)			
Leakage Current	$I \leq 3\sqrt{CV}$ Where, I:Max.leakage current (µA), C:Nominal capacitance (µF), V: Rated voltage (V) (at 20°C after 5 minutes)			
Dissipation Factor (tan δ)	Rated Voltage(V _{dc})	160~400	420~550	(at 20°C, 120Hz)
	tan δ (max.)	0.15	0.20	
Low Temperature Characteristics (Max. Impedance Ratio)	Rated Voltage(V _{dc})	160~250	315~550	(at 120Hz)
	Z(-25°C)/Z(+20°C)	4	8	
Endurance	The following specifications shall be satisfied when the capacitors are restored to 20°C after DC voltage plus the rated ripple current is applied for 5,000 hours at 105°C.			
	Capacitance Change	±20% of the initial value		
	D.F. (tan δ)	200% of the initial specified value (500V _{dc} : 250%; 550V _{dc} : 300%)		
	Leakage Current	The initial specified value		
Shelf Life	The following specifications shall be satisfied when the capacitors are restored to 20°C after exposing them for 1,000 hours at 105°C without voltage applied.			
	Capacitance Change	±15% of the initial value		
	D.F. (tan δ)	150% of the initial specified value		
	Leakage Current	200% of the initial specified value		

DIMENSIONS[mm]

- Terminal Code : K (22 to 35) : Standard

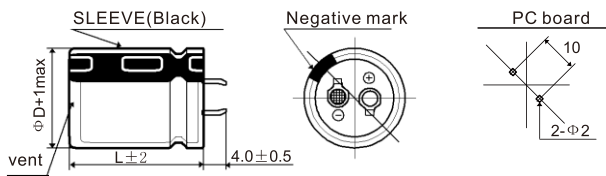

- Terminal Code : L (35)

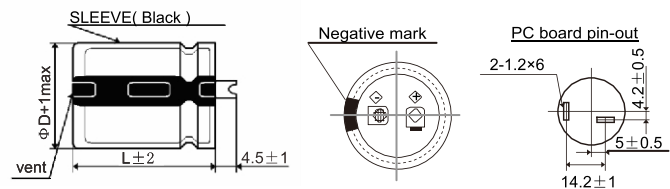

PART NUMBERING SYSTEM

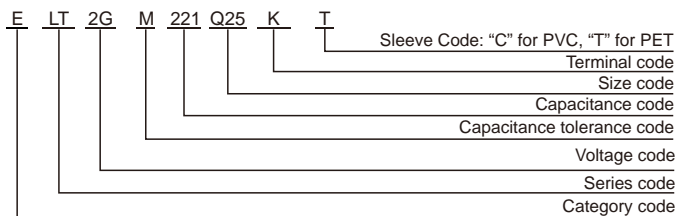

RATED RIPPLE CURRENT MULTIPLIERS

Frequency correction factor for ripple current

Rated voltage(V _{dc}) \ Freq.(Hz)	120	1k	10k	100k
160~250	1.00	1.32	1.45	1.50
315~550	1.00	1.30	1.41	1.43

The endurance of capacitors is shortened with internal heating produced by ripple current at the rate of halving the lifetime with every 5°C rise. When long life performance is required in actual use, the rms ripple current has to be reduced.

LT series

■ STANDARD RATINGS

WV (Vdc)	Cap (μF)	Size DxL(mm)	tan	Rated ripple current (Arms/105°C, 120Hz)	Part Number
160(2C)	390	22x25	0.15	1.32	ELT2CM391O25KT
	560	22x30	0.15	1.66	ELT2CM561O30KT
		25x25	0.15	1.68	ELT2CM561P25KT
	680	22x35	0.15	1.87	ELT2CM681O35KT
		25x30	0.15	1.88	ELT2CM681P30KT
		30x25	0.15	1.96	ELT2CM681Q25KT
	820	22x40	0.15	2.09	ELT2CM821O40KT
	1000	22x50	0.15	2.41	ELT2CM102O50KT
		25x35	0.15	2.38	ELT2CM102P35KT
		30x30	0.15	2.40	ELT2CM102Q30KT
		35x25	0.15	2.55	ELT2CM102R25KT
	1200	25x45	0.15	2.71	ELT2CM122P45KT
		30x40	0.15	2.77	ELT2CM122Q40KT
		35x30	0.15	2.86	ELT2CM122R30KT
	1500	25x50	0.15	3.08	ELT2CM152P50KT
		30x45	0.15	3.17	ELT2CM152Q45KT
	1800	35x35	0.15	3.22	ELT2CM152R35KT
		30x50	0.15	3.53	ELT2CM182Q50KT
	2200	35x40	0.15	3.66	ELT2CM182R40KT
		35x45	0.15	4.14	ELT2CM222R45KT
2700	35x50	0.15	4.68	ELT2CM272R50KT	
180(2L)	330	22x25	0.15	1.21	ELT2LM331O25KT
	470	22x30	0.15	1.52	ELT2LM471O30KT
		25x25	0.15	1.52	ELT2LM471P25KT
	560	22x35	0.15	1.70	ELT2LM561O35KT
		25x30	0.15	1.78	ELT2LM561P30KT
	680	22x40	0.15	1.91	ELT2LM681O40KT
		25x30	0.15	1.88	ELT2LM681P30KT
	820	22x45	0.15	1.99	ELT2LM821O45KT
		25x35	0.15	2.16	ELT2LM821P35KT
		30x30	0.15	2.17	ELT2LM821Q30KT
	1000	35x25	0.15	2.31	ELT2LM821R25KT
		22x50	0.15	2.25	ELT2LM102O50KT
		25x45	0.15	2.47	ELT2LM102P45KT
	1200	30x35	0.15	2.46	ELT2LM102Q35KT
		25x50	0.15	2.75	ELT2LM122P50KT
		30x40	0.15	2.77	ELT2LM122Q40KT
	1500	35x30	0.15	2.86	ELT2LM122R30KT
		30x50	0.15	3.22	ELT2LM152Q50KT
		35x35	0.15	3.22	ELT2LM152R35KT
	1800	35x45	0.15	3.74	ELT2LM182R45KT
2200	35x50	0.15	4.22	ELT2LM222R50KT	

WV (Vdc)	Cap (μF)	Size DxL(mm)	tan	Rated ripple current (Arms/105°C, 120Hz)	Part Number
200(2D)	270	22x25	0.15	1.10	ELT2DM271O25KT
	390	22x30	0.15	1.38	ELT2DM391O30KT
		25x25	0.15	1.39	ELT2DM391P25KT
	470	22x35	0.15	1.55	ELT2DM471O35KT
	560	22x40	0.15	1.73	ELT2DM561O40KT
		25x30	0.15	1.71	ELT2DM561P30KT
		30x25	0.15	1.78	ELT2DM561Q25KT
	680	22x45	0.15	1.81	ELT2DM681O45KT
		25x35	0.15	1.87	ELT2DM681P35KT
		30x30	0.15	1.98	ELT2DM681Q30KT
		35x25	0.15	2.10	ELT2DM681R25KT
	820	22x50	0.15	2.18	ELT2DM821O50KT
		25x40	0.15	2.09	ELT2DM821P40KT
		30x35	0.15	2.22	ELT2DM821Q35KT
	1000	25x50	0.15	2.39	ELT2DM102P50KT
		30x40	0.15	2.53	ELT2DM102Q40KT
		35x30	0.15	2.61	ELT2DM102R30KT
	1200	30x50	0.15	2.88	ELT2DM122Q50KT
		35x35	0.15	2.88	ELT2DM122R35KT
	1500	35x40	0.15	3.34	ELT2DM152R40KT
1800	35x50	0.15	3.82	ELT2DM182R50KT	
220(2N)	270	22x25	0.15	1.10	ELT2NM271O25KT
	330	22x30	0.15	1.19	ELT2NM331O30KT
	390	25x25	0.15	1.39	ELT2NM391P25KT
	470	22x35	0.15	1.55	ELT2NM471O35KT
		25x30	0.15	1.56	ELT2NM471P30KT
		30x25	0.15	1.63	ELT2NM471Q25KT
	560	22x40	0.15	1.73	ELT2NM561O40KT
		30x30	0.15	1.79	ELT2NM561Q30KT
		22x50	0.15	1.99	ELT2NM681O50KT
	680	25x35	0.15	1.96	ELT2NM681P35KT
		30x35	0.15	2.02	ELT2NM681Q35KT
		35x25	0.15	2.10	ELT2NM681R25KT
		25x45	0.15	2.24	ELT2NM821P45KT
	820	30x40	0.15	2.29	ELT2NM821Q40KT
		35x30	0.15	2.36	ELT2NM821R30KT
		25x50	0.15	2.51	ELT2NM102P50KT
	1000	30x45	0.15	2.59	ELT2NM102Q45KT
		35x35	0.15	2.63	ELT2NM102R35KT
		30x50	0.15	2.88	ELT2NM122Q50KT
	1200	35x40	0.15	2.98	ELT2NM122R40KT
1500		35x45	0.15	3.41	ELT2NM152R45KT
1800	35x50	0.15	3.82	ELT2NM182R50KT	

Snap-in&Lug Terminal Type

LT series

■ STANDARD RATINGS

WV (Vdc)	Cap (μF)	Size D×L(mm)	tan	Rated ripple current (Arms/105°C, 120Hz)	Part Number
250(2E)	220	22×25	0.15	1.01	ELT2EM221O25KT
	270	22×30	0.15	1.20	ELT2EM271O30KT
	330	25×25	0.15	1.32	ELT2EM331P25KT
	390	22×35	0.15	1.44	ELT2EM391O35KT
		25×30	0.15	1.43	ELT2EM391P30KT
		30×25	0.15	1.51	ELT2EM391Q25KT
	470	22×40	0.15	1.62	ELT2EM471O40KT
	560	22×50	0.15	1.84	ELT2EM561O50KT
		25×35	0.15	1.78	ELT2EM561P35KT
		30×30	0.15	1.83	ELT2EM561Q30KT
		35×25	0.15	1.91	ELT2EM561R25KT
	680	25×45	0.15	2.04	ELT2EM681P45KT
		30×35	0.15	2.06	ELT2EM681Q35KT
		35×30	0.15	2.15	ELT2EM681R30KT
	820	25×50	0.15	2.28	ELT2EM821P50KT
		30×45	0.15	2.39	ELT2EM821Q45KT
		35×35	0.15	2.38	ELT2EM821R35KT
	1000	30×50	0.15	2.68	ELT2EM102Q50KT
		35×40	0.15	2.72	ELT2EM102R40KT
	1200	35×45	0.15	3.05	ELT2EM122R45KT
1500	35×50	0.15	3.49	ELT2EM152R50KT	
315(2F)	150	22×25	0.15	0.80	ELT2FM151O25KT
	180	22×30	0.15	0.92	ELT2FM181O30KT
		25×25	0.15	0.94	ELT2FM181P25KT
	220	22×35	0.15	1.04	ELT2FM221O35KT
		30×25	0.15	1.17	ELT2FM221Q25KT
	270	22×40	0.15	1.18	ELT2FM271O40KT
		25×30	0.15	1.19	ELT2FM271P30KT
	330	22×45	0.15	1.33	ELT2FM331O45KT
		25×35	0.15	1.37	ELT2FM331P35KT
		30×30	0.15	1.40	ELT2FM331Q30KT
		35×25	0.15	1.49	ELT2FM331R25KT
	390	22×50	0.15	1.48	ELT2FM391O50KT
		25×40	0.15	1.52	ELT2FM391P40KT
	470	25×45	0.15	1.70	ELT2FM471P45KT
		30×35	0.15	1.71	ELT2FM471Q35KT
		35×30	0.15	1.82	ELT2FM471R30KT
	560	25×50	0.15	1.88	ELT2FM561P50KT
		30×45	0.15	1.97	ELT2FM561Q45KT
		35×35	0.15	2.00	ELT2FM561R35KT
	680	30×50	0.15	2.21	ELT2FM681Q50KT
35×40		0.15	2.29	ELT2FM681R40KT	
820	35×45	0.15	2.57	ELT2FM821R45KT	
1000	35×50	0.15	2.89	ELT2FM102R50KT	

WV (Vdc)	Cap (μF)	Size D×L(mm)	tan	Rated ripple current (Arms/105°C, 120Hz)	Part Number
350(2V)	120	22×25	0.15	0.72	ELT2VM121O25KT
	150	22×30	0.15	0.84	ELT2VM151O30KT
	180	25×25	0.15	0.94	ELT2VM181P25KT
	220	22×40	0.15	1.06	ELT2VM221O40KT
		25×30	0.15	1.07	ELT2VM221P30KT
		30×25	0.15	1.13	ELT2VM221Q25KT
	270	22×45	0.15	1.20	ELT2VM271O45KT
		25×35	0.15	1.24	ELT2VM271P35KT
		30×30	0.15	1.27	ELT2VM271Q30KT
		35×25	0.15	1.35	ELT2VM271R25KT
	330	22×50	0.15	1.36	ELT2VM331O50KT
		25×40	0.15	1.39	ELT2VM331P40KT
		30×35	0.15	1.43	ELT2VM331Q35KT
	390	25×45	0.15	1.55	ELT2VM391P45KT
		30×40	0.15	1.60	ELT2VM391Q40KT
		35×30	0.15	1.66	ELT2VM391R30KT
	470	25×50	0.15	1.72	ELT2VM471P50KT
		30×45	0.15	1.81	ELT2VM471Q45KT
		35×35	0.15	1.83	ELT2VM471R35KT
	560	30×50	0.15	2.00	ELT2VM561Q50KT
35×40		0.15	2.07	ELT2VM561R40KT	
680	35×45	0.15	2.34	ELT2VM681R45KT	
820	35×50	0.15	2.62	ELT2VM821R50KT	
400(2G)	100	22×25	0.15	0.66	ELT2GM101O25KT
	120	22×30	0.15	0.75	ELT2GM121O30KT
	150	22×35	0.15	0.86	ELT2GM151O35KT
		25×25	0.15	0.86	ELT2GM151P25KT
	180	22×40	0.15	0.96	ELT2GM181O40KT
		25×30	0.15	0.97	ELT2GM181P30KT
		30×25	0.15	1.02	ELT2GM181Q25KT
	220	22×45	0.15	1.09	ELT2GM221O45KT
		25×35	0.15	1.12	ELT2GM221P35KT
	270	30×25	0.15	1.22	ELT2GM221Q25KT
		22×50	0.15	1.23	ELT2GM271O50KT
		25×45	0.15	1.29	ELT2GM271P45KT
	330	30×30	0.15	1.27	ELT2GM271Q30KT
		25×50	0.15	1.44	ELT2GM331P50KT
		30×35	0.15	1.43	ELT2GM331Q35KT
	390	35×30	0.15	1.52	ELT2GM331R30KT
		30×40	0.15	1.60	ELT2GM391Q40KT
	470	35×35	0.15	1.67	ELT2GM391R35KT
		30×50	0.15	1.84	ELT2GM471Q50KT
	560	35×40	0.15	1.90	ELT2GM471R40KT
35×45		0.15	2.12	ELT2GM561R45KT	
680	35×50	0.15	2.39	ELT2GM681R50KT	

LT series

■ STANDARD RATINGS

WV (V _{dc})	Cap (μF)	Size D×L(mm)	tan	Rated ripple current (Arms/105°C, 120Hz)	Part Number
420(2T)	100	22×25	0.20	0.66	ELT2TM101O25KT
	120	22×30	0.20	0.75	ELT2TM121O30KT
		25×25	0.20	0.77	ELT2TM121P25KT
	150	22×35	0.20	0.86	ELT2TM151O35KT
	180	22×45	0.20	0.98	ELT2TM181O45KT
		25×35	0.20	1.01	ELT2TM181P35KT
		30×25	0.20	1.02	ELT2TM181Q25KT
	220	22×50	0.20	1.11	ELT2TM221O50KT
		25×40	0.20	1.14	ELT2TM221P40KT
		30×30	0.20	1.14	ELT2TM221Q30KT
	270	35×25	0.20	1.22	ELT2TM221R25KT
		25×45	0.20	1.29	ELT2TM271P45KT
		30×35	0.20	1.30	ELT2TM271Q35KT
		35×30	0.20	1.38	ELT2TM271R30KT
	330	25×50	0.20	1.44	ELT2TM331P50KT
		30×40	0.20	1.48	ELT2TM331Q40KT
		35×35	0.20	1.54	ELT2TM331R35KT
	390	30×45	0.20	1.64	ELT2TM391Q45KT
		35×40	0.20	1.73	ELT2TM391R40KT
	470	30×50	0.20	1.84	ELT2TM471Q50KT
35×45		0.20	1.94	ELT2TM471R45KT	
560	35×50	0.20	2.17	ELT2TM561R50KT	
450(2W)	82	22×25	0.20	0.59	ELT2WM820O25KT
	100	22×30	0.20	0.69	ELT2WM101O30KT
		25×25	0.20	0.70	ELT2WM101P25KT
	120	22×35	0.20	0.77	ELT2WM121O35KT
	150	22×45	0.20	0.90	ELT2WM151O45KT
		25×35	0.20	0.92	ELT2WM151P35KT
		30×25	0.20	0.93	ELT2WM151Q25KT
	180	22×50	0.20	1.01	ELT2WM181O50KT
		25×40	0.20	1.03	ELT2WM181P40KT
		30×30	0.20	1.03	ELT2WM181Q30KT
35×25		0.20	1.10	ELT2WM181R25KT	

WV (V _{dc})	Cap (μF)	Size D×L(mm)	tan	Rated ripple current (Arms/105°C, 120Hz)	Part Number
450(2W)	220	25×45	0.20	1.16	ELT2WM221P45KT
		30×35	0.20	1.17	ELT2WM221Q35KT
		35×30	0.20	1.24	ELT2WM221R30KT
	270	25×50	0.20	1.31	ELT2WM271P50KT
		30×40	0.20	1.33	ELT2WM271Q40KT
		35×35	0.20	1.39	ELT2WM271R35KT
	330	30×45	0.20	1.51	ELT2WM331Q45KT
	390	30×50	0.20	1.67	ELT2WM391Q50KT
		35×45	0.20	1.77	ELT2WM391R45KT
	470	35×50	0.20	1.98	ELT2WM471R50KT
500(2H)	100	30×25	0.20	0.82	ELT2HM101Q25KT
	120	30×30	0.20	0.91	ELT2HM121Q30KT
		35×25	0.20	0.88	ELT2HM121R25KT
	150	30×35	0.20	1.04	ELT2HM151Q35KT
	180	30×40	0.20	1.17	ELT2HM181Q40KT
		35×30	0.20	1.10	ELT2HM181R30KT
	220	30×45	0.20	1.33	ELT2HM221Q45KT
		35×35	0.20	1.23	ELT2HM221R35KT
	270	30×50	0.20	1.50	ELT2HM271Q50KT
		35×40	0.20	1.42	ELT2HM271R40KT
330	35×45	0.20	1.60	ELT2HM331R45KT	
390	35×50	0.20	1.78	ELT2HM391R50KT	
470	35×60	0.20	2.03	ELT2HM471R60KT	
550(2J)	120	30×30	0.20	0.91	ELT2JM121Q30KT
	150	30×35	0.20	1.04	ELT2JM151Q35KT
	180	30×40	0.20	1.17	ELT2JM181Q40KT
		35×30	0.20	1.10	ELT2JM181R30KT
	220	30×50	0.20	1.35	ELT2JM221Q50KT
		35×40	0.20	1.28	ELT2JM221R40KT
	270	35×45	0.20	1.45	ELT2JM271R45KT
	330	35×50	0.20	1.64	ELT2JM331R50KT
390	35×60	0.20	1.85	ELT2JM391R60KT	

LX series

- Extremely long life
- Endurance: 7,000 hours at 105°C
- RoHS Compliant



SPECIFICATIONS

Items	Characteristics		
Category Temperature Range	-25~+105°C		
Rated Voltage Range	160~450V.DC		
Capacitance Tolerance	±20%(M) (at 20°C,120Hz)		
Leakage Current	$I \leq 3\sqrt{CV}$ Where, I:Max.leakage current (µA),C:Nominal capacitance (µF),V: Rated voltage (V) (at 20°C after 5 minutes)		
Dissipation Factor (tan δ)	Rated Voltage(V _{dc})	160~400	420~450
	tan δ (max.)	0.15	0.20
Low Temperature Characteristics (Max. Impedance Ratio)	Rated Voltage(V _{dc})	160~400	420~450
	Z(-25°C)/Z(+20°C)	4	8
Endurance	The following specifications shall be satisfied when the capacitors are restored to 20°C after DC voltage plus the rated ripple current is applied for 7,000 hours at 105 °C.		
	Capacitance Change	±20% of the initial value	
	D.F. (tan δ)	250% of the initial specified value	
	Leakage Current	The initial specified value	
Shelf Life	The following specifications shall be satisfied when the capacitors are restored to 20°C after exposing them for 1,000 hours at 105°C without voltage applied.		
	Capacitance Change	±15% of the initial value	
	D.F. (tan δ)	150% of the initial specified value	
	Leakage Current	150% of the initial specified value	

DIMENSIONS[mm]

- Terminal Code : K (22 to 35) : Standard

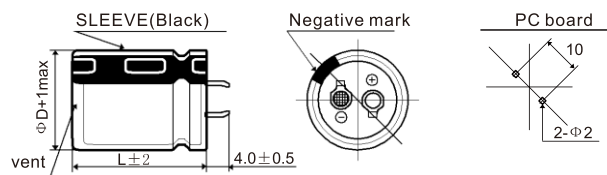

- Terminal Code : L (35)

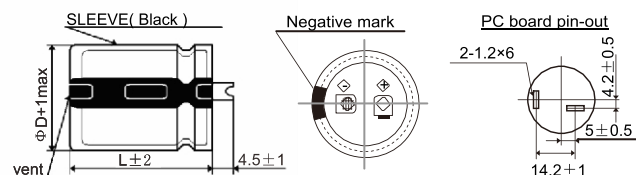

PART NUMBERING SYSTEM

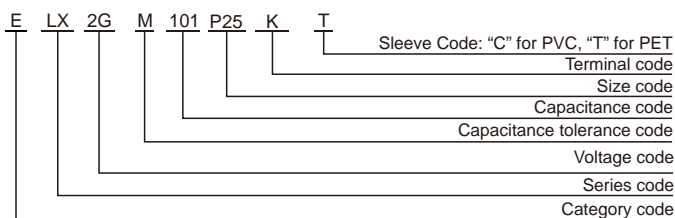

RATED RIPPLE CURRENT MULTIPLIERS

Frequency correction factor for ripple current

Rated voltage(V _{dc}) \ Freq.(Hz)	120	1k	10k	100k
160~250	1.00	1.32	1.45	1.50
315~450	1.00	1.30	1.41	1.43

The endurance of capacitors is shortened with internal heating produced by ripple current at the rate of halving the lifetime with every 5°C rise. When long life performance is required in actual use, the rms ripple current has to be reduced.

LX series

■ STANDARD RATINGS

WV (Vdc)	Cap (μF)	Size DxL(mm)	tan	Rated ripple current (Arms/105°C, 120Hz)	Part Number
160(2C)	330	22x25	0.15	1.11	ELX2CM331O25KT
	390	22x30	0.15	1.26	ELX2CM391O30KT
	470	22x30	0.15	1.39	ELX2CM471O30KT
		25x25	0.15	1.38	ELX2CM471P25KT
	560	22x35	0.15	1.55	ELX2CM561O35KT
		25x30	0.15	1.55	ELX2CM561P30KT
	680	22x40	0.15	1.75	ELX2CM681O40KT
		25x35	0.15	1.78	ELX2CM681P35KT
		30x25	0.15	1.74	ELX2CM681Q25KT
	820	22x50	0.15	1.97	ELX2CM821O50KT
		25x40	0.15	2.01	ELX2CM821P40KT
		30x30	0.15	1.96	ELX2CM821Q30KT
	1000	25x45	0.15	2.27	ELX2CM102P45KT
		30x35	0.15	2.26	ELX2CM102Q35KT
		25x50	0.15	2.54	ELX2CM122P50KT
	1200	30x40	0.15	2.56	ELX2CM122Q40KT
		35x30	0.15	2.52	ELX2CM122R30KT
		30x45	0.15	2.96	ELX2CM152Q45KT
	1500	35x35	0.15	2.89	ELX2CM152R35KT
		30x50	0.15	3.32	ELX2CM182Q50KT
1800	35x40	0.15	3.30	ELX2CM182R40KT	
	2200	35x50	0.15	3.87	ELX2CM222R50KT
180(2L)	270	22x25	0.15	1.00	ELX2LM271O25KT
	330	22x30	0.15	1.16	ELX2LM331O30KT
	390	22x30	0.15	1.26	ELX2LM391O30KT
		25x25	0.15	1.26	ELX2LM391P25KT
	470	22x35	0.15	1.42	ELX2LM471O35KT
		25x30	0.15	1.42	ELX2LM471P30KT
	560	22x40	0.15	1.59	ELX2LM561O40KT
		25x30	0.15	1.55	ELX2LM561P30KT
	680	30x25	0.15	1.58	ELX2LM561Q25KT
		22x45	0.15	1.79	ELX2LM681O45KT
		25x35	0.15	1.78	ELX2LM681P35KT
	820	30x30	0.15	1.79	ELX2LM681Q30KT
		25x40	0.15	2.01	ELX2LM821P40KT
		30x35	0.15	2.04	ELX2LM821Q35KT
	1000	25x50	0.15	2.32	ELX2LM102P50KT
		30x35	0.15	2.26	ELX2LM102Q35KT
		35x30	0.15	2.30	ELX2LM102R30KT
	1200	30x45	0.15	2.65	ELX2LM122Q45KT
		35x35	0.15	2.58	ELX2LM122R35KT
		30x50	0.15	3.03	ELX2LM152Q50KT
1500	35x40	0.15	3.01	ELX2LM152R40KT	
	1800	35x45	0.15	3.41	ELX2LM182R45KT
2200	35x50	0.15	3.87	ELX2LM222R50KT	
200(2D)	220	22x25	0.15	0.90	ELX2DM221O25KT
	270	22x30	0.15	1.05	ELX2DM271O30KT
		22x30	0.15	1.16	ELX2DM331O30KT
	330	25x25	0.15	1.16	ELX2DM331P25KT
		22x35	0.15	1.29	ELX2DM391O35KT
	390	25x30	0.15	1.29	ELX2DM391P30KT
		22x40	0.15	1.46	ELX2DM471O40KT
	470	25x30	0.15	1.42	ELX2DM471P30KT
		30x25	0.15	1.45	ELX2DM471Q25KT
		22x45	0.15	1.63	ELX2DM561O45KT
	560	25x35	0.15	1.62	ELX2DM561P35KT
		30x30	0.15	1.62	ELX2DM561Q30KT

WV (Vdc)	Cap (μF)	Size DxL(mm)	tan	Rated ripple current (Arms/105°C, 120Hz)	Part Number
200(2D)	680	25x40	0.15	1.83	ELX2DM681P40KT
		30x30	0.15	1.79	ELX2DM681Q30KT
	820	25x45	0.15	2.06	ELX2DM821P45KT
		30x35	0.15	2.04	ELX2DM821Q35KT
	1000	30x45	0.15	2.42	ELX2DM102Q45KT
		35x30	0.15	2.30	ELX2DM102R30KT
		30x50	0.15	2.71	ELX2DM122Q50KT
	1200	35x40	0.15	2.70	ELX2DM122R40KT
		1500	35x45	0.15	3.11
	1800	35x50	0.15	3.50	ELX2DM182R50KT
220(2N)	220	22x25	0.15	0.90	ELX2NM221O25KT
	270	22x30	0.15	1.05	ELX2NM271O30KT
	330	22x35	0.15	1.19	ELX2NM331O35KT
		25x25	0.15	1.16	ELX2NM331P25KT
	390	22x40	0.15	1.33	ELX2NM391O40KT
		25x30	0.15	1.29	ELX2NM391P30KT
	470	22x45	0.15	1.49	ELX2NM471O45KT
		25x35	0.15	1.48	ELX2NM471P35KT
		30x25	0.15	1.45	ELX2NM471Q25KT
		22x50	0.15	1.63	ELX2NM561O50KT
		25x40	0.15	1.71	ELX2NM561P40KT
	560	30x30	0.15	1.62	ELX2NM561Q30KT
		25x45	0.15	1.87	ELX2NM681P45KT
		30x35	0.15	1.86	ELX2NM681Q35KT
	820	25x50	0.15	2.10	ELX2NM821P50KT
30x40		0.15	2.12	ELX2NM821Q40KT	
35x30		0.15	2.08	ELX2NM821R30KT	
30x50		0.15	2.48	ELX2NM102Q50KT	
35x40		0.15	2.46	ELX2NM102R40KT	
1200	35x45	0.15	2.78	ELX2NM122R45KT	
1500	35x50	0.15	3.20	ELX2NM152R50KT	
250(2E)	180	22x25	0.15	0.82	ELX2EM181O25KT
	220	22x30	0.15	0.95	ELX2EM221O30KT
		22x35	0.15	1.08	ELX2EM271O35KT
	270	25x25	0.15	1.05	ELX2EM271P25KT
		22x40	0.15	1.22	ELX2EM331O40KT
	330	25x30	0.15	1.19	ELX2EM331P30KT
		22x45	0.15	1.36	ELX2EM391O45KT
	390	25x35	0.15	1.35	ELX2EM391P35KT
		30x25	0.15	1.32	ELX2EM391Q25KT
		22x50	0.15	1.49	ELX2EM471O50KT
	470	25x40	0.15	1.52	ELX2EM471P40KT
		30x30	0.15	1.49	ELX2EM471Q30KT
		25x45	0.15	1.70	ELX2EM561P45KT
	560	30x35	0.15	1.69	ELX2EM561Q35KT
		25x50	0.15	1.91	ELX2EM681P50KT
30x40		0.15	1.93	ELX2EM681Q40KT	
820	35x30	0.15	1.90	ELX2EM681R30KT	
	30x45	0.15	2.19	ELX2EM821Q45KT	
	35x35	0.15	2.13	ELX2EM821R35KT	
1000	35x40	0.15	2.46	ELX2EM102R40KT	
1200	35x50	0.15	2.86	ELX2EM122R50KT	
315(2F)	100	22x25	0.15	0.67	ELX2FM101O25KT
	120	22x30	0.15	0.77	ELX2FM121O30KT
	150	22x30	0.15	0.86	ELX2FM151O30KT
25x25		0.15	0.85	ELX2FM151P25KT	

Snap-in&Lug Terminal Type

LX series

■ STANDARD RATINGS

WV (Vdc)	Cap (μF)	Size DxL(mm)	tan	Rated ripple current (Arms/105°C, 120Hz)	Part Number	
315(2F)	180	22x35	0.15	0.96	ELX2FM181O35KT	
		25x30	0.15	0.96	ELX2FM181P30KT	
	220	220	22x40	0.15	1.09	ELX2FM221O40KT
			25x30	0.15	1.06	ELX2FM221P30KT
		30x25	0.15	1.08	ELX2FM221Q25KT	
	270	220	22x45	0.15	1.24	ELX2FM271O45KT
			25x35	0.15	1.23	ELX2FM271P35KT
		30x30	0.15	1.23	ELX2FM271Q30KT	
	330	250	25x40	0.15	1.40	ELX2FM331P40KT
			30x35	0.15	1.42	ELX2FM331Q35KT
		35x30	0.15	1.45	ELX2FM331R30KT	
	390	250	25x50	0.15	1.59	ELX2FM391P50KT
			30x35	0.15	1.54	ELX2FM391Q35KT
	470	350	35x30	0.15	1.57	ELX2FM391R35KT
			30x45	0.15	1.81	ELX2FM471Q45KT
	560	470	35x35	0.15	1.77	ELX2FM471R35KT
			30x50	0.15	2.03	ELX2FM561Q50KT
		560	35x40	0.15	2.02	ELX2FM561R40KT
680			35x45	0.15	2.29	ELX2FM681R45KT
820	35x50	0.15	2.59	ELX2FM821R50KT		
350(2V)	100	22x25	0.15	0.67	ELX2VM101O25KT	
		22x30	0.15	0.77	ELX2VM121O30KT	
	120	220	25x25	0.15	0.76	ELX2VM121P25KT
			22x35	0.15	0.88	ELX2VM151O35KT
	150	250	25x30	0.15	0.88	ELX2VM151P30KT
			22x40	0.15	0.99	ELX2VM181O40KT
	180	250	25x30	0.15	0.96	ELX2VM181P30KT
			30x25	0.15	0.98	ELX2VM181Q25KT
		22x45	0.15	1.12	ELX2VM221O45KT	
	220	250	25x35	0.15	1.11	ELX2VM221P35KT
			30x30	0.15	1.11	ELX2VM221Q30KT
		25x40	0.15	1.26	ELX2VM271P40KT	
	270	300	30x35	0.15	1.28	ELX2VM271Q35KT
			25x45	0.15	1.40	ELX2VM331P45KT
	330	300	30x35	0.15	1.42	ELX2VM331Q35KT
			35x30	0.15	1.45	ELX2VM331R30KT
		30x40	0.15	1.60	ELX2VM391Q40KT	
	390	350	35x35	0.15	1.61	ELX2VM391R35KT
30x50			0.15	1.86	ELX2VM471Q50KT	
470	350	35x40	0.15	1.85	ELX2VM471R40KT	
		560	35x40	0.15	2.02	ELX2VM561R40KT
680	35x50	0.15	2.36	ELX2VM681R50KT		
400(2G)	68	22x25	0.15	0.55	ELX2GM680O25KT	
		82	22x30	0.15	0.63	ELX2GM820O30KT
	100	220	22x30	0.15	0.70	ELX2GM101O30KT
			25x25	0.15	0.70	ELX2GM101P25KT
	120	250	22x35	0.15	0.79	ELX2GM121O35KT
			25x30	0.15	0.79	ELX2GM121P30KT
	150	220	22x40	0.15	0.90	ELX2GM151O40KT
			25x30	0.15	0.88	ELX2GM151P30KT
	180	300	30x25	0.15	0.90	ELX2GM151Q25KT
			22x45	0.15	0.99	ELX2GM181O45KT
	220	250	25x35	0.15	1.01	ELX2GM181P35KT
			30x30	0.15	1.01	ELX2GM181Q30KT
	270	350	25x40	0.15	1.14	ELX2GM221P40KT
			30x35	0.15	1.16	ELX2GM221Q35KT

WV (Vdc)	Cap (μF)	Size DxL(mm)	tan	Rated ripple current (Arms/105°C, 120Hz)	Part Number	
400(2G)	270	25x50	0.15	1.32	ELX2GM271P50KT	
		30x40	0.15	1.33	ELX2GM271Q40KT	
		35x30	0.15	1.31	ELX2GM271R30KT	
	330	300	30x45	0.15	1.52	ELX2GM331Q45KT
			35x35	0.15	1.48	ELX2GM331R35KT
		30x50	0.15	1.69	ELX2GM391Q50KT	
	390	350	35x40	0.15	1.68	ELX2GM391R40KT
			470	35x45	0.15	1.91
	560	35x50	0.15	2.14	ELX2GM561R50KT	
	420(2T)	56	22x25	0.20	0.50	ELX2TM560O25KT
68			22x30	0.20	0.58	ELX2TM680O30KT
82		220	22x30	0.20	0.63	ELX2TM820O30KT
			25x25	0.20	0.63	ELX2TM820P25KT
100		250	22x35	0.20	0.72	ELX2TM101O35KT
			25x30	0.20	0.72	ELX2TM101P30KT
120		220	22x40	0.20	0.81	ELX2TM121O40KT
			25x30	0.20	0.79	ELX2TM121P30KT
		30x25	0.20	0.80	ELX2TM121Q25KT	
150		220	22x45	0.20	0.92	ELX2TM151O45KT
			25x35	0.20	0.92	ELX2TM151P35KT
		30x30	0.20	0.92	ELX2TM151Q30KT	
180		250	25x40	0.20	1.03	ELX2TM181P40KT
			30x35	0.20	1.05	ELX2TM181Q35KT
		25x50	0.20	1.19	ELX2TM221P50KT	
220		300	30x35	0.20	1.16	ELX2TM221Q35KT
			35x30	0.20	1.18	ELX2TM221R30KT
		30x45	0.20	1.38	ELX2TM271Q45KT	
270	350	35x35	0.20	1.34	ELX2TM271R35KT	
		30x50	0.20	1.56	ELX2TM331Q50KT	
330	350	35x40	0.20	1.55	ELX2TM331R40KT	
		390	35x45	0.20	1.74	ELX2TM391R45KT
470	35x50	0.20	1.96	ELX2TM471R50KT		
450(2W)	47	22x25	0.20	0.46	ELX2WM470O25KT	
		56	22x30	0.20	0.52	ELX2WM560O30KT
	68	220	22x30	0.20	0.58	ELX2WM680O30KT
			25x25	0.20	0.58	ELX2WM680P25KT
	82	250	22x35	0.20	0.65	ELX2WM820O35KT
			25x30	0.20	0.65	ELX2WM820P30KT
	100	220	22x40	0.20	0.74	ELX2WM101O40KT
			25x30	0.20	0.72	ELX2WM101P30KT
		30x25	0.20	0.73	ELX2WM101Q25KT	
	120	220	22x45	0.20	0.83	ELX2WM121O45KT
			25x35	0.20	0.82	ELX2WM121P35KT
		30x30	0.20	0.82	ELX2WM121Q30KT	
	150	250	25x40	0.20	0.94	ELX2WM151P40KT
			30x35	0.20	0.96	ELX2WM151Q35KT
	180	250	25x45	0.20	1.06	ELX2WM181P45KT
			30x35	0.20	1.05	ELX2WM181Q35KT
	220	300	35x30	0.20	1.07	ELX2WM181R30KT
			30x40	0.20	1.20	ELX2WM221Q40KT
270	350	35x35	0.20	1.21	ELX2WM221R35KT	
		30x50	0.20	1.41	ELX2WM271Q50KT	
330	350	35x40	0.20	1.40	ELX2WM271R40KT	
		390	35x45	0.20	1.60	ELX2WM331R45KT
390	35x50	0.20	1.79	ELX2WM391R50KT		

LB series

- High reliability. Extremely long life series
- Endurance with ripple current: 10,000 hours at 105°C
- RoHS Compliant



SPECIFICATIONS

Items	Characteristics		
Category Temperature Range	-25~+105°C		
Rated Voltage Range	200~450V.DC		
Capacitance Tolerance	±20%(M) (at 20°C,120Hz)		
Leakage Current	$I \leq 3\sqrt{CV}$ Where, I:Max.leakage current (μA),C:Nominal capacitance (μF),V: Rated voltage (V) (at 20°C after 5 minutes)		
Dissipation Factor (tan δ)	Rated Voltage(V _{dc})	200~400	450
	tan δ (max.)	0.15	0.20
Low Temperature Characteristics (Max. Impedance Ratio)	Rated Voltage(V _{dc})	200~400	450
	Z(-25°C)/Z(+20°C)	4	8
Endurance	The following specifications shall be satisfied when the capacitors are restored to 20°C after DC voltage plus the rated ripple current is applied for 10,000 hours at 105 °C.		
	Capacitance Change	±20% of the initial value	
	D.F. (tan δ)	250% of the initial specified value	
	Leakage Current	The initial specified value	
Shelf Life	The following specifications shall be satisfied when the capacitors are restored to 20°C after exposing them for 1,000 hours at 105°C without voltage applied.		
	Capacitance Change	±15% of the initial value	
	D.F. (tan δ)	150% of the initial specified value	
	Leakage Current	200% of the initial specified value	

DIMENSIONS[mm]

- Terminal Code : K (22 to 35) : Standard

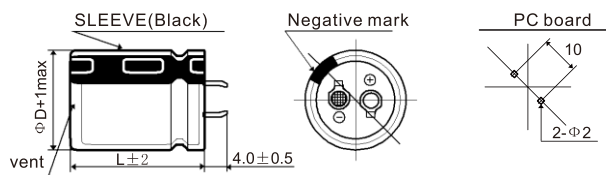

- Terminal Code : L (35)

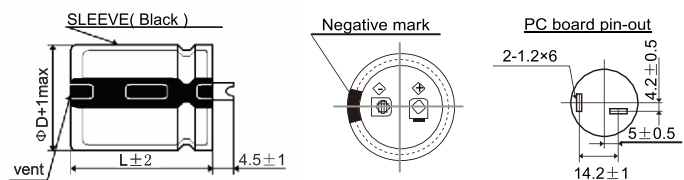

PART NUMBERING SYSTEM

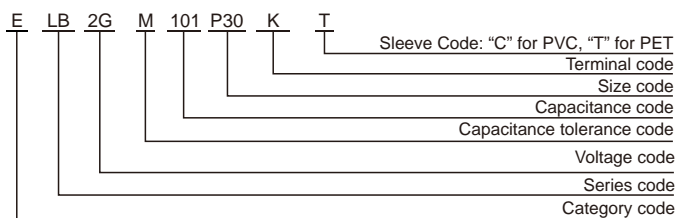

RATED RIPPLE CURRENT MULTIPLIERS

Frequency correction factor for ripple current

Rated voltage(V _{dc}) \ Freq.(Hz)	120	1k	10k	100k
200, 250	1.00	1.32	1.45	1.50
400, 450	1.00	1.30	1.41	1.43

The endurance of capacitors is shortened with internal heating produced by ripple current at the rate of halving the lifetime with every 5°C rise. When long life performance is required in actual use, the rms ripple current has to be reduced.

LB series

■ STANDARD RATINGS

WV (Vdc)	Cap (μF)	Size DxL(mm)	tan	Rated ripple current (Arms/105°C, 120Hz)	Part Number
200(2D)	220	22x25	0.15	1.01	ELB2DM221O25KT
	270	22x30	0.15	1.09	ELB2DM271O30KT
		25x25	0.15	1.12	ELB2DM271P25KT
	330	22x30	0.15	1.21	ELB2DM331O30KT
		25x25	0.15	1.21	ELB2DM331P25KT
	390	22x35	0.15	1.32	ELB2DM391O35KT
		25x30	0.15	1.29	ELB2DM391P30KT
		30x25	0.15	1.31	ELB2DM391Q25KT
	470	22x40	0.15	1.41	ELB2DM471O40KT
		25x35	0.15	1.42	ELB2DM471P35KT
		30x30	0.15	1.40	ELB2DM471Q30KT
	560	22x45	0.15	1.52	ELB2DM561O45KT
		25x35	0.15	1.51	ELB2DM561P35KT
		30x30	0.15	1.52	ELB2DM561Q30KT
	680	25x40	0.15	1.72	ELB2DM681P40KT
		30x35	0.15	1.71	ELB2DM681Q35KT
	820	25x50	0.15	2.01	ELB2DM821P50KT
		30x40	0.15	2.02	ELB2DM821Q40KT
		35x30	0.15	2.01	ELB2DM821R30KT
	1000	30x45	0.15	2.20	ELB2DM102Q45KT
35x35		0.15	2.21	ELB2DM102R35KT	
1200	30x50	0.15	2.32	ELB2DM122Q50KT	
	35x40	0.15	2.31	ELB2DM122R40KT	
1500	35x50	0.15	2.51	ELB2DM152R50KT	
250(2E)	180	22x30	0.15	0.91	ELB2EM181O30KT
		25x25	0.15	0.90	ELB2EM181P25KT
	220	22x30	0.15	1.01	ELB2EM221O30KT
		25x25	0.15	1.00	ELB2EM221P25KT
	270	22x35	0.15	1.11	ELB2EM271O35KT
		25x30	0.15	1.10	ELB2EM271P30KT
		30x25	0.15	1.12	ELB2EM271Q25KT
	330	22x40	0.15	1.20	ELB2EM331O40KT
		25x35	0.15	1.21	ELB2EM331P35KT
		30x25	0.15	1.20	ELB2EM331Q25KT
	390	22x45	0.15	1.30	ELB2EM391O45KT
		25x35	0.15	1.32	ELB2EM391P35KT
		30x30	0.15	1.33	ELB2EM391Q30KT
	470	25x45	0.15	1.40	ELB2EM471P45KT
		30x35	0.15	1.42	ELB2EM471Q35KT
		35x30	0.15	1.40	ELB2EM471R30KT
	560	25x50	0.15	1.51	ELB2EM561P50KT
		30x35	0.15	1.50	ELB2EM561Q35KT
		35x30	0.15	1.52	ELB2EM561R30KT
	680	30x45	0.15	1.72	ELB2EM681Q45KT
35x35		0.15	1.71	ELB2EM681R35KT	
820	30x50	0.15	2.01	ELB2EM821Q50KT	
	35x40	0.15	2.01	ELB2EM821R40KT	
1000	35x45	0.15	2.22	ELB2EM102R45KT	
1200	35x50	0.15	2.32	ELB2EM122R50KT	

WV (Vdc)	Cap (μF)	Size DxL(mm)	tan	Rated ripple current (Arms/105°C, 120Hz)	Part Number
400(2G)	56	22x25	0.15	0.51	ELB2GM560O25KT
	68	22x30	0.15	0.55	ELB2GM680O30KT
		25x25	0.15	0.56	ELB2GM680P25KT
	82	22x35	0.15	0.64	ELB2GM820O35KT
		25x25	0.15	0.65	ELB2GM820P25KT
	100	22x35	0.15	0.70	ELB2GM101O35KT
		25x30	0.15	0.69	ELB2GM101P30KT
	120	22x40	0.15	0.75	ELB2GM121O40KT
		25x35	0.15	0.76	ELB2GM121P35KT
		30x25	0.15	0.75	ELB2GM121Q25KT
	150	22x50	0.15	0.82	ELB2GM151O50KT
		25x40	0.15	0.83	ELB2GM151P40KT
		30x30	0.15	0.82	ELB2GM151Q30KT
	180	25x45	0.15	0.90	ELB2GM181P45KT
		30x35	0.15	0.91	ELB2GM181Q35KT
		35x25	0.15	0.90	ELB2GM181R25KT
	220	25x50	0.15	1.01	ELB2GM221P50KT
		30x40	0.15	1.02	ELB2GM221Q40KT
		35x30	0.15	1.00	ELB2GM221R30KT
	270	30x45	0.15	1.10	ELB2GM271Q45KT
35x35		0.15	1.10	ELB2GM271R35KT	
330	30x50	0.15	1.20	ELB2GM331Q50KT	
	35x40	0.15	1.21	ELB2GM331R40KT	
390	35x45	0.15	1.29	ELB2GM391R45KT	
470	35x50	0.15	1.35	ELB2GM471R50KT	
450(2W)	39	22x25	0.20	0.37	ELB2WM390O25KT
	47	22x30	0.20	0.40	ELB2WM470O30KT
	56	22x35	0.20	0.47	ELB2WM560O35KT
		25x25	0.20	0.48	ELB2WM560P25KT
	68	22x40	0.20	0.53	ELB2WM680O40KT
		25x30	0.20	0.53	ELB2WM680P30KT
	82	22x45	0.20	0.56	ELB2WM820O45KT
		25x35	0.20	0.56	ELB2WM820P35KT
		30x25	0.20	0.56	ELB2WM820Q25KT
	100	22x50	0.20	0.64	ELB2WM101O50KT
		25x40	0.20	0.64	ELB2WM101P40KT
		30x30	0.20	0.64	ELB2WM101Q30KT
	120	25x45	0.20	0.72	ELB2WM121P45KT
		30x30	0.20	0.72	ELB2WM121Q30KT
		25x50	0.20	0.79	ELB2WM151P50KT
	150	30x40	0.20	0.79	ELB2WM151Q40KT
		35x30	0.20	0.78	ELB2WM151R30KT
	180	30x45	0.20	0.87	ELB2WM181Q45KT
		35x35	0.20	0.87	ELB2WM181R35KT
	220	30x50	0.20	1.00	ELB2WM221Q50KT
35x40		0.20	1.01	ELB2WM221R40KT	
270	35x45	0.20	1.19	ELB2WM271R45KT	
330	35x50	0.20	1.38	ELB2WM331R50KT	

LU series

- No sparks against DC over-voltage
- Endurance: 2,000 hours at 105°C
- RoHS Compliant



SPECIFICATIONS

Items	Characteristics			
Category Temperature Range	-25~+105°C			
Rated Voltage Range	200~450V.DC			
Capacitance Tolerance	±20%(M) (at 20°C, 120Hz)			
Leakage Current	$I \leq 3\sqrt{CV}$ Where, I: Max.leakage current (μA), C: Nominal capacitance (μF), V: Rated voltage(V) (at 20°C after 5 minutes)			
ESL	50nH max. (at 20°C, 1MHz)			
Dissipation Factor (tan δ)	200V.DC: 0.15 max. (0.02 max. for D=35mm) 400V.DC: 0.15 max. (at 20°C, 120Hz)			
Low Temperature Characteristics (Max. Impedance Ratio)	Rated Voltage(V.DC)	200~250	400~450	(at 120Hz)
	Z(-25°C)/Z(+20°C)	4	8	
Endurance	The following specifications shall be satisfied when the capacitors are restored to 20°C after DC voltage plus the rated ripple current is applied for 2,000 hours at 105 °C.			
	Capacitance Change	±20% of the initial value		
	D.F. (tan δ)	200% of the initial specified value		
	Leakage Current	The initial specified value		
Shelf Life	The following specifications shall be satisfied when the capacitors are restored to 20°C after exposing them for 1,000 hours at 105°C without voltage applied.			
	Capacitance Change	±15% of the initial value		
	D.F. (tan δ)	150% of the initial specified value		
	Leakage Current	200% of the initial specified value		

DIMENSIONS[mm]

- Terminal Code : K (22 to 35) : Standard

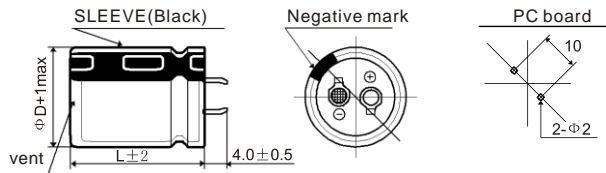

PART NUMBERING SYSTEM

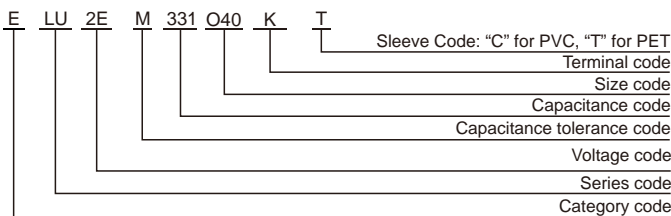

RATED RIPPLE CURRENT MULTIPLIERS

Frequency correction factor for ripple current

Rated voltage(V _{dc})	Freq.(Hz)			
	120	1k	10k	100k
200~250	1.00	1.32	1.45	1.50
400~450	1.00	1.30	1.41	1.43

The endurance of capacitors is shortened with internal heating produced by ripple current at the rate of halving the lifetime with every 5°C rise. When long life performance is required in actual use, the rms ripple current has to be reduced.

LU series

■ STANDARD RATINGS

WV (Vdc)	Cap (μF)	Size DxL(mm)	tan	Rated ripple current (Arms/105°C, 120Hz)	Part Number
200(2D)	180	22x20	0.15	0.82	ELU2DM181O20KT
	220	22x20	0.15	0.90	ELU2DM221O20KT
	270	22x25	0.15	1.02	ELU2DM271O25KT
	330	22x30	0.15	1.20	ELU2DM331O30KT
		25x25	0.15	1.20	ELU2DM331P25KT
	390	22x30	0.15	1.35	ELU2DM391O30KT
		25x25	0.15	1.35	ELU2DM391P25KT
	470	22x35	0.15	1.45	ELU2DM471O35KT
		25x30	0.15	1.45	ELU2DM471P30KT
		30x25	0.15	1.47	ELU2DM471Q25KT
	560	22x40	0.15	1.62	ELU2DM561O40KT
		25x30	0.15	1.60	ELU2DM561P30KT
		30x25	0.15	1.60	ELU2DM561Q25KT
	680	25x35	0.15	1.82	ELU2DM681P35KT
		30x30	0.15	1.81	ELU2DM681Q30KT
		35x25	0.20	1.86	ELU2DM681R25KT
	820	25x45	0.15	2.11	ELU2DM821P45KT
		30x35	0.15	2.11	ELU2DM821Q35KT
		35x25	0.20	2.11	ELU2DM821R25KT
	1000	30x35	0.15	2.40	ELU2DM102Q35KT
		35x30	0.20	2.40	ELU2DM102R30KT
	1200	30x45	0.15	2.69	ELU2DM122Q45KT
		35x35	0.20	2.65	ELU2DM122R35KT
	250(2E)	120	22x20	0.15	0.68
180		22x25	0.15	0.87	ELU2EM181O25KT
		25x20	0.15	0.93	ELU2EM181P20KT
220		22x30	0.15	1.00	ELU2EM221O30KT
270		22x35	0.15	1.14	ELU2EM271O35KT
		25x25	0.15	1.13	ELU2EM271P25KT
		30x20	0.15	1.25	ELU2EM271Q20KT
330		22x40	0.15	1.28	ELU2EM331O40KT
		25x30	0.15	1.29	ELU2EM331P30KT
390		22x45	0.15	1.42	ELU2EM391O45KT
		25x35	0.15	1.46	ELU2EM391P35KT
		30x25	0.15	1.52	ELU2EM391Q25KT

WV (Vdc)	Cap (μF)	Size DxL(mm)	tan	Rated ripple current (Arms/105°C, 120Hz)	Part Number
250(2E)	390	35x20	0.20	1.62	ELU2EM391R20KT
	470	25x40	0.15	1.64	ELU2EM471P40KT
		30x30	0.15	1.67	ELU2EM471Q30KT
	560	25x45	0.15	1.82	ELU2EM561P45KT
		30x35	0.15	1.87	ELU2EM561Q35KT
		35x25	0.20	1.99	ELU2EM561R25KT
	680	30x40	0.15	2.12	ELU2EM681Q40KT
		35x30	0.20	2.19	ELU2EM681R30KT
	820	30x45	0.15	2.39	ELU2EM821Q45KT
		35x35	0.20	2.42	ELU2EM821R35KT
400(2G)	56	22x20	0.15	0.45	ELU2GM560O20KT
	68	22x20	0.15	0.51	ELU2GM680O20KT
	82	22x25	0.15	0.58	ELU2GM820O25KT
	100	22x25	0.15	0.66	ELU2GM101O25KT
		25x25	0.15	0.66	ELU2GM101P25KT
	120	22x30	0.15	0.76	ELU2GM121O30KT
		25x25	0.15	0.76	ELU2GM121P25KT
	150	22x35	0.15	0.85	ELU2GM151O35KT
		25x30	0.15	0.85	ELU2GM151P30KT
		30x25	0.15	0.85	ELU2GM151Q25KT
	180	22x40	0.15	0.94	ELU2GM181O40KT
		25x35	0.15	0.95	ELU2GM181P35KT
		30x25	0.15	0.95	ELU2GM181Q25KT
		25x35	0.15	1.24	ELU2GM221P35KT
	220	30x30	0.15	1.24	ELU2GM221Q30KT
		35x25	0.15	1.24	ELU2GM221R25KT
		25x45	0.15	1.30	ELU2GM271P45KT
	270	30x35	0.15	1.30	ELU2GM271Q35KT
35x25		0.15	1.30	ELU2GM271R25KT	
330	30x40	0.15	1.47	ELU2GM331Q40KT	
	35x30	0.15	1.47	ELU2GM331R30KT	
450(2W)	180	30x35	0.20	1.00	ELU2WM181Q35KT
	220	30x40	0.20	1.20	ELU2WM221Q40KT
	390	35x40	0.20	1.60	ELU2WM391R40KT

■ DC OVERVOLTAGE TEST CONDITIONS

The vent will operate and the capacitor shall become open-circuited without burning materials when the following excess DC voltage is applied.

■ Test DC voltage

Rated Voltage	Nominal Capacitance	Current Limit	Test DC Voltage
200Vdc	<330μF	4A	300/375Vdc
	330μF C<470μF	5A	
	470μF	7A	
250Vdc	<100μF	4A	350/450Vdc
	100μF C<220μF	5A	
	220μF	7A	
400Vdc	<100μF	2A	500/600Vdc
	100μF C<220μF	4A	
	220μF	7A	
450Vdc	<100μF	2A	550/675Vdc
	100μF C<220μF	4A	
	220μF	7A	

■ Test Circuit

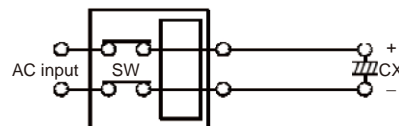

Constant DC voltage/current power supply

NR series

- Endurance with ripple current: 2,000 hours at 85°C
- Applications: Uninterruptible power supplies and frequency converters
- Detail specification: IEC 60384-4
- RoHS Compliant



SPECIFICATIONS

Items	Characteristics	
Category Temperature Range	-25~+85°C(350~550 V _{dc})	
Surge Voltage	1.10* V _R	
Rated Capacitance Range	1000~15000µF	
Rated Voltage Range	350~550 V _{dc}	
Capacitance Tolerance	±20% (M) (at 20°C, 120Hz)	
Leakage Current	I=0.02CV [µA] or 5mA, whichever is smaller. Where, I: Max.leakage current (µA), C : Rated capacitance (µF), V : Rated voltage (V) (at 20°C after 5 minutes)	
Dissipation Factor (tan δ)	0.20 (at 20°C, 120Hz)	
Low Temperature Characteristics	Capacitance Change C(-25°C)/C(+20°C) 0.7 (at 120Hz)	
Insulation Resistance	When measured between the terminals shorted each other and the mounting clamp on the insulating sleeve covering the case by using an insulation resistance meter of 500V _{dc} , the insulation resistance shall not be less than 100MΩ.	
Insulation Withstanding Voltage	When a voltage of 2,000Vac is applied for 1 minute between the terminals shorted each other and the mounting clamp on the insulating sleeve covering the case, there shall not be electrical damage.	
Endurance	The following specifications shall be satisfied when the capacitors are restored to 20°C after DC voltage plus the rated ripple current is applied for 2,000 hours at 85°C.	
	Capacitance Change	±20% of the initial value
	D.F. (tan δ)	200% of the initial specified value
Shelf Life	The following specifications shall be satisfied when the capacitors are restored to 20°C after exposing them for 1,000 hours at 85°C without voltage applied.	
	Capacitance Change	±20% of the initial value
	D.F. (tan δ)	150% of the initial specified value
	Leakage Current	The initial specified value

DIMENSIONS(Screw-Mount)[mm]

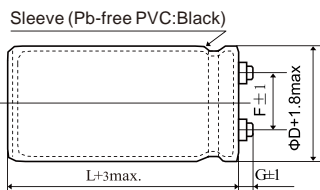

Ø35 to Ø51.6:G=7
Ø64.3 to Ø91:G=6.5

• Mounting Clamp Type:I

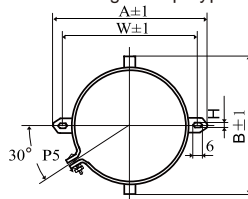

ØD	A	B	W	F
35	58.0	44.0	48.0	12.7
51.6	80.0	62.0	68.0	22.2
64.3	93.0	82.0	81.0	28.5
77	106.0	94.0	93.5	31.7

• Mounting Clamp Type:Y

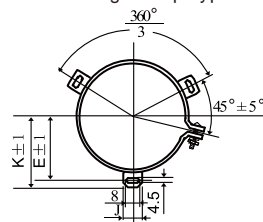

ØD	E	K	J	F
51.6	32.5	35.8	14.0	22.2
64.3	38.4	42.5	14.0	28.5
77	44.5	47.5	14.0	31.7
91	50.8	54.7	14.0	31.7

<Screw specifications>
Plus hexagon-headed screw:
M5x0.8x10 or M6x1.0x12
Maximum screw tightening torque:3.23Nm

* The screw and the mounting clamp are separately supplied and not attached to the product.

PART NUMBERING SYSTEM

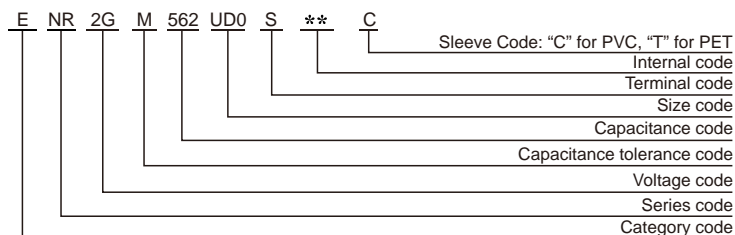

RATED RIPPLE CURRENT MULTIPLIERS

- Frequency Coefficient

Frequency(Hz)	50	120	300	1k	3k
Coefficient	0.8	1.0	1.1	1.3	1.4

The endurance of capacitors is shortened with internal heating produced by ripple current at the rate of halving the lifetime with every 5 or 10°C rise. When long life performance is required in actual use, the rms ripple current has to be reduced.

NR series

■ STANDARD RATINGS

WV (V _{dc})	Cap (μF)	Case size D×L(mm)	tan	ESR typ. 120Hz 20°C m	ESR max. 120Hz 20°C m	Rated ripple current (Arms/85°C, 120Hz)	Part Number
350(2V)	1000	51.6×65	0.20	82	123	3.6	ENR2VM102S65*00C
	2200	51.6×105	0.20	51	77	7.6	ENR2VM222SA5*00C
	2700	64.3×96	0.20	46	68	8.9	ENR2VM272T96*00C
	3300	64.3×105	0.20	35	52	10.0	ENR2VM332TA5*00C
	3900	64.3×115	0.20	31	46	11.4	ENR2VM392TB5*00C
	4700	76.9×105	0.20	28	42	13.5	ENR2VM472UA5*00C
	5600	76.9×115	0.20	24	35	15.4	ENR2VM562UB5*00C
	6800	76.9×143	0.20	21	31	17.3	ENR2VM682UE3*00C
	8200	76.9×168	0.20	18	27	19.8	ENR2VM822UG8*00C
	10000	91×157	0.20	15	22	23.7	ENR2VM103VF7*00C
	12000	91×168	0.20	13	19	24.3	ENR2VM123VG8*00C
15000	91×196	0.20	11	16	29.2	ENR2VM153VJ6*00C	
400(2G)	1000	51.6×65	0.20	88	131	3.7	ENR2GM102S65*00C
	2200	51.6×115	0.20	58	87	7.5	ENR2GM222SB5*00C
	2700	64.3×96	0.20	47	71	9.0	ENR2GM272T96*00C
	3300	64.3×115	0.20	39	58	10.6	ENR2GM332TB5*00C
	3900	64.3×130	0.20	33	49	12.5	ENR2GM392TD0*00C
	4700	76.9×115	0.20	30	45	14.1	ENR2GM472UB5*00C
	5600	76.9×130	0.20	26	39	16.8	ENR2GM562UD0*00C
	6800	76.9×155	0.20	24	35	17.6	ENR2GM682UF5*00C
	8200	91×157	0.20	19	29	21.5	ENR2GM822VF7*00C
	10000	91×168	0.20	17	26	22.8	ENR2GM103VG8*00C
	12000	91×196	0.20	15	22	26.6	ENR2GM123VJ6*00C
15000	91×220	0.20	13	18	27.4	ENR2GM153VM0*00C	
450(2W)	1800	51.6×130	0.20	68	102	6.5	ENR2WM182SD0*00C
	2200	64.3×96	0.20	56	83	7.8	ENR2WM222T96*00C
	2700	64.3×115	0.20	45	68	8.8	ENR2WM272TB5*00C
	3300	64.3×130	0.20	37	55	10.7	ENR2WM332TD0*00C
	3900	76.9×115	0.20	31	46	12.0	ENR2WM392UB5*00C
	4700	76.9×130	0.20	27	41	14.1	ENR2WM472UD0*00C
	5600	76.9×155	0.20	25	38	16.0	ENR2WM562UF5*00C
	6800	91×157	0.20	21	31	18.8	ENR2WM682VF7*00C
	8200	91×157	0.20	17	28	19.1	ENR2WM822VF7*00C
	10000	91×196	0.20	13	25	21.2	ENR2WM103VJ6*00C
	12000	91×220	0.20	11	22	23.7	ENR2WM123VM0*00C
500(2H)	2200	64.3×115	0.25	54	80	7.3	ENR2HM222TB5*00C
	2700	64.3×130	0.25	43	64	8.5	ENR2HM272TD0*00C
	3300	76.9×115	0.25	36	53	10.0	ENR2HM332UB5*00C
	3900	76.9×130	0.25	30	47	11.4	ENR2HM392UD0*00C
	4700	76.9×155	0.25	27	40	13.3	ENR2HM472UF5*00C
	5600	91×157	0.25	25	38	14.8	ENR2HM562VF7*00C
	8200	91×196	0.25	16	26	18.1	ENR2HM822VJ6*00C
	10000	91×220	0.25	15	24	22.2	ENR2HM103VM0*00V
550(2J)	1500	64.3×115	0.30	60	95	7.0	ENR2JM152TB5*00C
	2200	76.9×105	0.30	52	78	8.1	ENR2JM222UA5*00C
	2700	76.9×115	0.30	42	62	9.0	ENR2JM272UB5*00C
	3300	76.9×130	0.30	35	51	10.5	ENR2JM332UD0*00C
	3900	76.9×155	0.30	29	45	11.0	ENR2JM392UF5*00C
	4700	91×157	0.30	26	38	12.9	ENR2JM472VF7*00C

Note: "*" may be "A" or "B" or "S" or "T".
S: Ring clip mounting special design

A: Ring clip mounting standard design
T: Threaded stud special design

B: Threaded stud standard design

NS series

- Endurance with ripple current: 2,000 hours at 105°C
- Applications: Uninterruptible power supplies and frequency converters
- Detail specification: IEC 60384-4
- RoHS Compliant



SPECIFICATIONS

Items	Characteristics
Category Temperature Range	-25~+105°C(350~450 V _{dc})
Surge Voltage	1.10* V _R
Rated Capacitance Range	1000~15000µF
Rated Voltage Range	350~450 V _{dc}
Capacitance Tolerance	±20% (M) (at 20°C, 120Hz)
Leakage Current	I=0.02CV [µA] or 5mA, whichever is smaller. Where, I: Max.leakage current (µA), C : Rated capacitance (µF), V : Rated voltage (V) (at 20°C after 5 minutes)
Dissipation Factor (tan)	0.20 (at 20°C, 120Hz)
Low Temperature Characteristics	Capacitance Change C(-25°C)/C(+20°C) 0.7 (at 120Hz)
Insulation Resistance	When measured between the terminals shorted each other and the mounting clamp on the insulating sleeve covering the case by using an insulation resistance meter of 500V _{dc} , the insulation resistance shall not be less than 100M .
Insulation Withstanding Voltage	When a voltage of 2,000Vac is applied for 1 minute between the terminals shorted each other and the mounting clamp on the insulating sleeve covering the case, there shall not be electrical damage.
Endurance	The following specifications shall be satisfied when the capacitors are restored to 20°C after DC voltage plus the rated ripple current is applied for 2,000 hours at 105°C.
	Capacitance Change ±20% of the initial value
	D.F. (tan) 200% of the initial specified value
Shelf Life	The following specifications shall be satisfied when the capacitors are restored to 20°C after exposing them for 1,000 hours at 105°C without voltage applied.
	Capacitance Change ±20% of the initial value
	D.F. (tan) 150% of the initial specified value
	Leakage Current The initial specified value

DIMENSIONS(Screw-Mount)[mm]

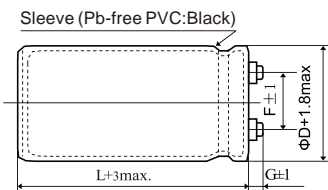

Ø35 to Ø51.6:G=7
Ø64.3 to Ø91:G=6.5

● Mounting Clamp Type:I

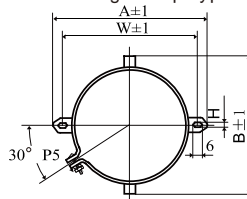

ØD	A	B	W	F
35	58.0	44.0	48.0	12.7
51.6	80.0	62.0	68.0	22.2
64.3	93.0	82.0	81.0	28.5
77	106.0	94.0	93.5	31.7

● Mounting Clamp Type:Y

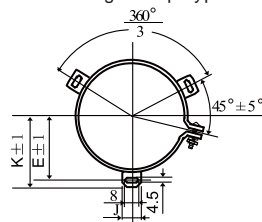

ØD	E	K	J	F
51.6	32.5	35.8	14.0	22.2
64.3	38.4	42.5	14.0	28.5
77	44.5	47.5	14.0	31.7
91	50.8	54.7	14.0	31.7

<Screw specifications>
Plus hexagon-headed screw:
M5x0.8x10 or M6x1.0x12
Maximum screw tightening torque:3.23Nm

* The screw and the mounting clamp are separately supplied and not attached to the product.

PART NUMBERING SYSTEM

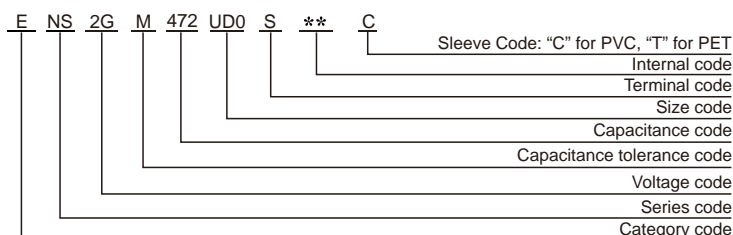

RATED RIPPLE CURRENT MULTIPLIERS

- Frequency Coefficient

Frequency(Hz)	50	120	300	1k	3k
Coefficient	0.8	1.0	1.1	1.3	1.4

The endurance of capacitors is shortened with internal heating produced by ripple current at the rate of halving the lifetime with every 5 or 10°C rise. When long life performance is required in actual use, the rms ripple current has to be reduced.

NS series

■ STANDARD RATINGS

WV (V _{dc})	Cap (μF)	Case size D×L(mm)	tan	ESR typ. 120Hz 20°C m	ESR max. 120Hz 20°C m	Rated ripple current (Arms/105°C, 120Hz)	Part Number
350(2V)	1000	51.6×80	0.20	108	157	2.6	ENS2VM102S80*00C
	1500	51.6×80	0.20	79	116	3.2	ENS2VM152S80*00C
	2200	51.6×96	0.20	57	81	4.2	ENS2VM222S96*00C
	3300	64.3×105	0.20	43	59	5.1	ENS2VM332TA5*00C
	3900	64.3×115	0.20	39	54	6.7	ENS2VM392TB5*00C
	4700	64.3×143	0.20	35	48	7.2	ENS2VM472TE3*00C
	5600	76.9×130	0.20	30	40	8.5	ENS2VM562UD0*00C
	6800	76.9×143	0.20	27	36	10.0	ENS2VM682UE3*00C
	8200	76.9×168	0.20	23	31	11.7	ENS2VM822UG8*00C
	10000	76.9×196	0.20	19	28	14.3	ENS2VM103UJ6*00C
	12000	76.9×220	0.20	17	25	16.8	ENS2VM123UM0*00C
15000	91.0×196	0.20	16	24	18.3	ENS2VM153VJ6*00C	
400(2G)	1000	51.6×80	0.20	109	158	3.0	ENS2GM102S80*00C
	1500	51.6×96	0.20	75	107	3.7	ENS2GM152S96*00C
	2200	64.3×105	0.20	35	76	4.6	ENS2GM222TA5*00C
	3300	64.3×130	0.20	31	53	6.4	ENS2GM332TD0*00C
	3900	76.9×115	0.20	28	46	7.9	ENS2GM392UB5*00C
	4700	76.9×130	0.20	23	40	8.0	ENS2GM472UD0*00C
	5600	76.9×143	0.20	21	36	9.8	ENS2GM562UE3*00C
	6800	76.9×168	0.20	14	31	10.5	ENS2GM682UG8*00C
	8200	76.9×196	0.20	14	30	13.3	ENS2GM822UJ6*00C
	10000	76.9×220	0.20	12	25	17.5	ENS2GM103UM0*00C
	12000	91.0×196	0.20	11	23	21.3	ENS2GM123VJ6*00C
450(2W)	1000	51.6×105	0.20	95	153	4.3	ENS2WM102SA5*00C
	1500	51.6×115	0.20	63	102	5.8	ENS2WM152SB5*00C
	2200	64.3×115	0.20	43	75	7.3	ENS2WM222TB5*00C
	3300	76.9×130	0.20	27	51	10.1	ENS2WM332UD0*00C
	3900	76.9×143	0.20	23	45	10.9	ENS2WM392UE3*00C
	4700	76.9×168	0.20	20	40	12.7	ENS2WM472UG8*00C
	5600	76.9×196	0.20	17	36	15.9	ENS2WM562UJ6*00C
	6800	76.9×220	0.20	14	32	16.4	ENS2WM682UM0*00C
	8200	91.0×196	0.20	11	24	17.0	ENS2WM822VJ6*00C
	10000	91.0×220	0.20	9	21	18.8	ENS2WM103VM0*00C

Note: "*" may be "A" or "B" or "S" or "T".
 A: Ring clip mounting standard design
 B: Threaded stud standard design
 S: Ring clip mounting special design
 T: Threaded stud special design

NX series

- Endurance with ripple current: 5,000 hours at 85°C
- Applications: Professional power supplies, Solar and wind generator and frequency converters
- Detail specification: IEC 60384-4
- RoHS Compliant



SPECIFICATIONS

Items	Characteristics
Category Temperature Range	-25~+85°C(350~500 V _{dc})
Surge Voltage	1.10* V _R
Rated Capacitance Range	1000~12000µF
Rated Voltage Range	350~500 V _{dc}
Capacitance Tolerance	±20% (M) (at 20°C, 120Hz)
Leakage Current	I=0.02CV [µA] or 5mA, whichever is smaller. Where, I: Max.leakage current (µA), C : Rated capacitance (µF), V : Rated voltage (V) (at 20°C after 5 minutes)
Dissipation Factor (tan)	0.20 (at 20°C, 120Hz)
Low Temperature Characteristics	Capacitance Change C(-25°C)/C(+20°C) 0.7 (at 120Hz)
Insulation Resistance	When measured between the terminals shorted each other and the mounting clamp on the insulating sleeve covering the case by using an insulation resistance meter of 500V _{dc} , the insulation resistance shall not be less than 100M .
Insulation Withstanding Voltage	When a voltage of 2,000Vac is applied for 1 minute between the terminals shorted each other and the mounting clamp on the insulating sleeve covering the case, there shall not be electrical damage.
Endurance	The following specifications shall be satisfied when the capacitors are restored to 20°C after DC voltage plus the rated ripple current is applied for 5,000 hours at 85°C.
	Capacitance Change ±20% of the initial value
	D.F. (tan) 200% of the initial specified value
Shelf Life	The following specifications shall be satisfied when the capacitors are restored to 20°C after exposing them for 1,000 hours at 85°C without voltage applied.
	Capacitance Change ±20% of the initial value
	D.F. (tan) 150% of the initial specified value
	Leakage Current The initial specified value

DIMENSIONS(Screw-Mount)[mm]

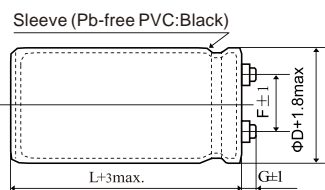

∅35 to ∅51.6:G=7
∅64.3 to ∅91:G=6.5

• Mounting Clamp Type:I

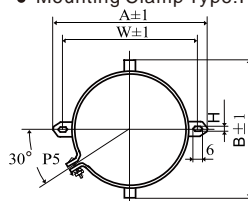

∅D	A	B	W	F
35	58.0	44.0	48.0	12.7
51.6	80.0	62.0	68.0	22.2
64.3	93.0	82.0	81.0	28.5
77	106.0	94.0	93.5	31.7

• Mounting Clamp Type:Y

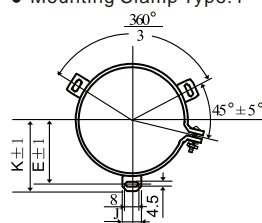

∅D	E	K	J	F
51.6	32.5	35.8	14.0	22.2
64.3	38.4	42.5	14.0	28.5
77	44.5	47.5	14.0	31.7
91	50.8	54.7	14.0	31.7

<Screw specifications>
Plus hexagon-headed screw:
M5x0.8x10 or M6x1.0x12
Maximum screw tightening torque:3.23Nm

* The screw and the mounting clamp are separately supplied and not attached to the product.

PART NUMBERING SYSTEM

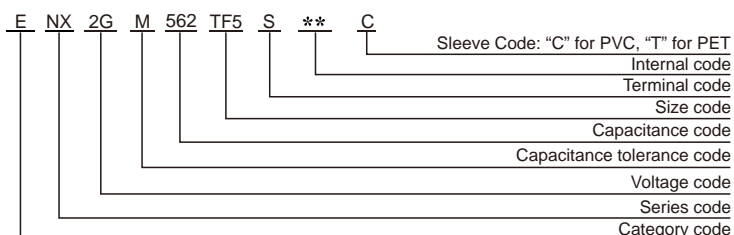

RATED RIPPLE CURRENT MULTIPLIERS

- Frequency Coefficient

Frequency(Hz)	50	120	300	1k	3k
Coefficient	0.8	1.0	1.1	1.3	1.4

The endurance of capacitors is shortened with internal heating produced by ripple current at the rate of halving the lifetime with every 5 or 10°C rise. When long life performance is required in actual use, the rms ripple current has to be reduced.

NX series

■ STANDARD RATINGS

WV (V _{dc})	Cap (μF)	Case size D×L(mm)	tan	ESR typ. 120Hz 20°C m	ESR max. 120Hz 20°C m	Rated ripple current (Arms/85°C, 120Hz)	Part Number
350(2V)	1500	51.6×80	0.20	86	130	6.0	ENX2VM152S80*00C
	2200	51.6×105	0.20	59	89	7.9	ENX2VM222SA5*00C
	2700	64.3×96	0.20	47	70	9.3	ENX2VM272T96*00C
	3300	64.3×105	0.20	39	58	10.9	ENX2VM332TA5*00C
	3900	64.3×115	0.20	33	49	12.3	ENX2VM392TB5*00C
	4700	64.3×130	0.20	29	45	14.2	ENX2VM472TD0*00C
	5600	76.9×115	0.20	26	39	16.6	ENX2VM562UB5*00C
	6800	76.9×130	0.20	21	32	19.0	ENX2VM682UD0*00C
	8200	76.9×155	0.20	18	26	22.3	ENX2VM822UF5*00C
	10000	91×157	0.20	14	19	25.2	ENX2VM103VF7*00C
12000	91×168	0.20	12	17	29.3	ENX2VM123VG8*00C	
400(2G)	1000	51.6×75	0.20	92	153	4.7	ENX2GM102S75*00C
	1500	51.6×80	0.20	63	113	6.1	ENX2GM152S80*00C
	2200	51.6×115	0.20	41	85	8.9	ENX2GM222SB5*00C
	2700	64.3×96	0.20	31	69	10.3	ENX2GM272T96*00C
	3300	64.3×115	0.20	28	58	11.3	ENX2GM332TB5*00C
	3900	64.3×130	0.20	25	49	13.0	ENX2GM392TD0*00C
	4700	64.3×143	0.20	22	40	15.4	ENX2GM472TE3*00C
	5600	64.3×155	0.20	21	35	18.3	ENX2GM562TF5*00C
	6800	76.9×155	0.20	19	30	20.4	ENX2GM682UF5*00C
	8200	76.9×168	0.20	15	26	22.8	ENX2GM822UG8*00C
10000	91×157	0.20	13	21	26.9	ENX2GM103VF7*00C	
12000	91×196	0.20	10	18	30.5	ENX2GM123VJ6*00C	
450(2W)	1000	51.6×80	0.20	115	169	5.0	ENX2WM102S80*00C
	1500	51.6×105	0.20	75	112	6.5	ENX2WM152SA5*00C
	2200	64.3×105	0.20	58	90	8.9	ENX2WM222TA5*00C
	2700	64.3×115	0.20	39	74	10.3	ENX2WM272TB5*00C
	3300	64.3×130	0.20	28	58	12.0	ENX2WM332TD0*00C
	3900	76.9×115	0.20	23	48	13.9	ENX2WM392UB5*00C
	4700	76.9×130	0.20	20	39	16.0	ENX2WM472UD0*00C
	5600	76.9×155	0.20	16	36	18.5	ENX2WM562UF5*00C
	6800	76.9×168	0.20	14	30	20.8	ENX2WM682UG8*00C
	8200	91×157	0.20	13	25	24.5	ENX2WM822VF7*00C
10000	91×196	0.20	11	22	28.0	ENX2WM103VJ6*00C	
500(2H)	1000	51.6×105	0.25	110	165	4.9	ENX2HM102SA5*00C
	1500	64.3×105	0.25	74	110	7.8	ENX2HM152TA5*00C
	2200	64.3×130	0.25	56	88	10.0	ENX2HM222TD0*00C
	2700	64.3×143	0.25	48	72	11.6	ENX2HM272TE3*00C
	3300	76.9×130	0.25	37	56	13.1	ENX2HM332UD0*00C
	3900	76.9×155	0.25	32	46	14.5	ENX2HM392UF5*00C
	4700	76.9×168	0.25	25	38	16.6	ENX2HM472UG8*00C

Note: "*" may be "A" or "B" or "S" or "T".
A: Ring clip mounting standard design
B: Threaded stud standard design
S: Ring clip mounting special design
T: Threaded stud special design

NL series

- Endurance with ripple current: 12,000 hours at 85°C
- Applications: Professional power supplies, Solar and wind generator and frequency converters
- Detail specification: IEC 60384-4
- RoHS Compliant



SPECIFICATIONS

Items	Characteristics
Category Temperature Range	-25~+85°C(350~450 V _{dc})
Surge Voltage	1.10* V _R
Rated Capacitance Range	1500~15000μF
Rated Voltage Range	350~450 V _{dc}
Capacitance Tolerance	±20% (M) (at 20°C, 120Hz)
Leakage Current	I=0.02CV [μA] or 5mA, whichever is smaller. Where, I: Max.leakage current (μA), C : Rated capacitance (μF), V : Rated voltage (V) (at 20°C after 5 minutes)
Dissipation Factor (tan)	0.20 (at 20°C, 120Hz)
Low Temperature Characteristics	Capacitance Change C(-25°C)/C(+20°C) 0.7 (at 120Hz)
Insulation Resistance	When measured between the terminals shorted each other and the mounting clamp on the insulating sleeve covering the case by using an insulation resistance meter of 500V _{dc} , the insulation resistance shall not be less than 100M .
Insulation Withstanding Voltage	When a voltage of 2,000Vac is applied for 1 minute between the terminals shorted each other and the mounting clamp on the insulating sleeve covering the case, there shall not be electrical damage.
Endurance	The following specifications shall be satisfied when the capacitors are restored to 20°C after DC voltage plus the rated ripple current is applied for 12,000 hours at 85°C.
	Capacitance Change ±20% of the initial value
	D.F. (tan) 200% of the initial specified value
	Leakage Current The initial specified value
Shelf Life	The following specifications shall be satisfied when the capacitors are restored to 20°C after exposing them for 1,000 hours at 85°C without voltage applied.
	Capacitance Change ±20% of the initial value
	D.F. (tan) 150% of the initial specified value
	Leakage current The initial specified value

DIMENSIONS(Screw-Mount)[mm]

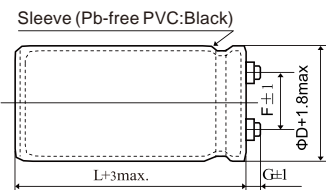

Ø35 to Ø51.6:G=7
Ø64.3 to Ø91:G=6.5

● Mounting Clamp Type:I

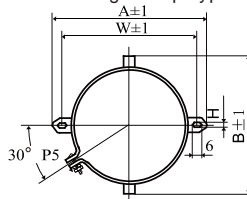

ØD	A	B	W	F
35	58.0	44.0	48.0	12.7
51.6	80.0	62.0	68.0	22.2
64.3	93.0	82.0	81.0	28.5
77	106.0	94.0	93.5	31.7

● Mounting Clamp Type:Y

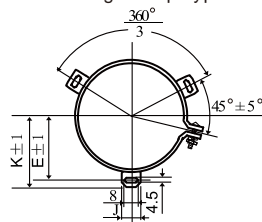

ØD	E	K	J	F
51.6	32.5	35.8	14.0	22.2
64.3	38.4	42.5	14.0	28.5
77	44.5	47.5	14.0	31.7
91	50.8	54.7	14.0	31.7

<Screw specifications>
Plus hexagon-headed screw:
M5x0.8x10 or M6x1.0x12
Maximum screw tightening torque:3.23Nm

* The screw and the mounting clamp are separately supplied and not attached to the product.

PART NUMBERING SYSTEM

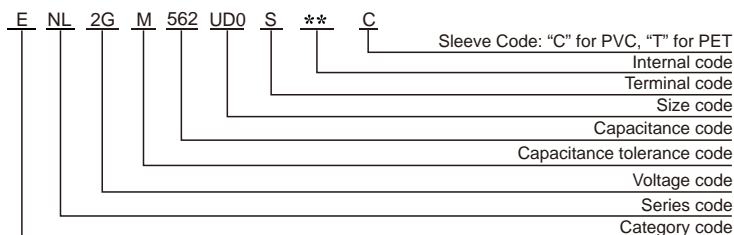

RATED RIPPLE CURRENT MULTIPLIERS

- Frequency Coefficient

Frequency(Hz)	50	120	300	1k	3k
Coefficient	0.8	1.0	1.1	1.3	1.4

The endurance of capacitors is shortened with internal heating produced by ripple current at the rate of halving the lifetime with every 5 or 10°C rise. When long life performance is required in actual use, the rms ripple current has to be reduced.

NL series

■ STANDARD RATINGS

WV (V _{dc})	Cap (μF)	Case size D×L(mm)	tan	ESR typ. 120Hz 20°C m	ESR max. 120Hz 20°C m	Rated ripple current (Arms/85°C,120Hz)	Part Number
350(2V)	1500	51.6×80	0.20	57	98	6.0	ENL2VM152S80*00C
	2200	51.6×105	0.20	45	78	7.8	ENL2VM222SA5*00C
	3300	64.3×115	0.20	36	53	10.5	ENL2VM332TB5*00C
	3900	64.3×130	0.20	32	47	12.6	ENL2VM392TD0*00C
	4700	76.9×105	0.20	30	43	14.0	ENL2VM472UA5*00C
	5600	76.9×115	0.20	27	37	15.5	ENL2VM562UB5*00C
	6800	76.9×130	0.20	23	34	18.1	ENL2VM682UD0*00C
	8200	76.9×155	0.20	20	28	21.5	ENL2VM822UF5*00C
	10000	91.0×157	0.20	16	24	24.6	ENL2VM103VF7*00C
	12000	91.0×196	0.20	14	22	29.0	ENL2VM123VJ6*00C
15000	91.0×220	0.20	11	18	34.1	ENL2VM153VM0*00C	
400(2G)	1500	51.6×80	0.20	58	89	6.1	ENL2GM152S80*00C
	2200	51.6×115	0.20	56	81	8.2	ENL2GM222SB5*00C
	3300	64.3×130	0.20	37	55	11.6	ENL2GM332TD0*00C
	3900	64.3×155	0.20	29	49	15.5	ENL2GM392TF5*00C
	4700	76.9×115	0.20	26	43	19.4	ENL2GM472UB5*00C
	5600	76.9×130	0.20	25	40	21.3	ENL2GM562UD0*00C
	6800	76.9×155	0.20	20	34	23.4	ENL2GM682UF5*00C
	8200	91.0×157	0.20	19	29	24.2	ENL2GM822VF7*00C
	10000	91.0×168	0.20	13	23	30.3	ENL2GM103VG8*00C
	12000	91.0×196	0.20	11	19	35.5	ENL2GM123VJ6*00C
450(2W)	1500	51.6×115	0.20	56	97	7.1	ENL2WM152SB5*00C
	2200	64.3×115	0.20	43	65	10.5	ENL2WM222TB5*00C
	3300	64.3×143	0.20	33	49	14.8	ENL2WM332TE3*00C
	3900	64.3×155	0.20	29	41	16.5	ENL2WM392TF5*00C
	4700	76.9×143	0.20	22	39	19.8	ENL2WM472UE3*00C
	5600	76.9×168	0.20	20	35	21.9	ENL2WM562UG8*00C
	6800	76.9×196	0.20	18	30	26.4	ENL2WM682UJ6*00C
	8200	91.0×168	0.20	16	24	29.6	ENL2WM822VG8*00C
	10000	91.0×196	0.20	15	21	31.8	ENL2WM103VJ6*00C

Note: "*" may be "A" or "B" or "S" or "T".
A: Ring clip mounting standard design
B: Threaded stud standard design
S: Ring clip mounting special design
T: Threaded stud special design

NE series

- Endurance of 20,000 hours application of rated ripple current at 85°C
- Applications: Professional power supplies, solar and wind generator and frequency converters
- Detail specification: IEC 60384-4
- RoHS Compliant



SPECIFICATIONS

Items	Characteristics
Category Temperature Range	-25~+85°C(350~450 V _{dc})
Surge Voltage	1.10* V _R
Rated Capacitance Range	1500~15000µF
Rated Voltage Range	350~450 V _{dc}
Capacitance Tolerance	±20% (M) (at 20°C, 120Hz)
Leakage Current	I=0.02CV [µA] or 5mA, whichever is smaller. Where, I: Max.leakage current (µA), C : Rated capacitance (µF), V : Rated voltage (V) (at 20°C after 5 minutes)
Dissipation Factor (tan)	0.20 (at 20°C, 120Hz)
Low Temperature Characteristics	Capacitance Change C(-25°C)/C(+20°C) 0.7 (at 120Hz)
Insulation Resistance	When measured between the terminals shorted each other and the mounting clamp on the insulating sleeve covering the case by using an insulation resistance meter of 500V _{dc} , the insulation resistance shall not be less than 100M .
Insulation Withstanding Voltage	When a voltage of 2,000Vac is applied for 1 minute between the terminals shorted each other and the mounting clamp on the insulating sleeve covering the case, there shall not be electrical damage.
Endurance	The following specifications shall be satisfied when the capacitors are restored to 20°C after DC voltage plus the rated ripple current is applied for 20,000 hours at 85°C.
	Capacitance Change ±20% of the initial value
	D.F. (tan) 200% of the initial specified value
Shelf Life	The following specifications shall be satisfied when the capacitors are restored to 20°C after exposing them for 1,000 hours at 85°C without voltage applied.
	Capacitance Change ±20% of the initial value
	D.F. (tan) 150% of the initial specified value
	Leakage Current The initial specified value

DIMENSIONS(Screw-Mount)[mm]

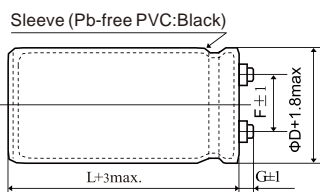

Ø35 to Ø51.6:G=7
Ø64.3 to Ø91:G=6.5

• Mounting Clamp Type:I

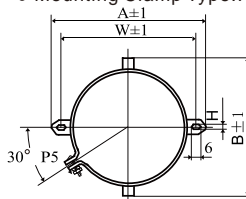

ØD	A	B	W	F
35	58.0	44.0	48.0	12.7
51.6	80.0	62.0	68.0	22.2
64.3	93.0	82.0	81.0	28.5
77	106.0	94.0	93.5	31.7

• Mounting Clamp Type:Y

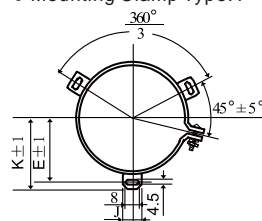

ØD	E	K	J	F
51.6	32.5	35.8	14.0	22.2
64.3	38.4	42.5	14.0	28.5
77	44.5	47.5	14.0	31.7
91	50.8	54.7	14.0	31.7

<Screw specifications>
Plus hexagon-headed screw:
M5x0.8x10 or M6x1.0x12
Maximum screw tightening torque:3.23Nm

* The screw and the mounting clamp are separately supplied and not attached to the product.

PART NUMBERING SYSTEM

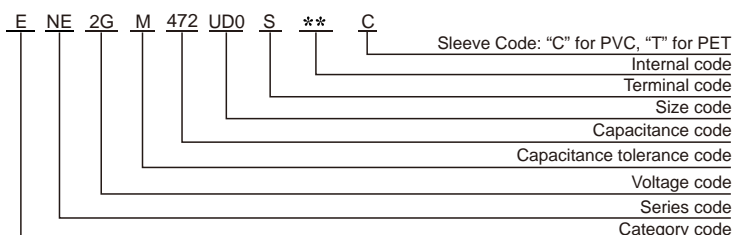

RATED RIPPLE CURRENT MULTIPLIERS

- Frequency Coefficient

Frequency(Hz)	50	120	300	1k	3k
Coefficient	0.8	1.0	1.1	1.3	1.4

The endurance of capacitors is shortened with internal heating produced by ripple current at the rate of halving the lifetime with every 5 or 10°C rise. When long life performance is required in actual use, the rms ripple current has to be reduced.

NE series

■ STANDARD RATINGS

WV (V _{dc})	Cap (μF)	Case size D×L(mm)	tan	ESR typ. 120Hz 20°C m	ESR max. 120Hz 20°C m	Rated ripple current (Arms/85°C, 120Hz)	Part Number
350(2V)	1500	51.6×96	0.20	67	98	5.4	ENE2VM152S96*00C
	2200	51.6×130	0.20	53	78	7.3	ENE2VM222SD0*00C
	3300	64.3×115	0.20	36	53	11.3	ENE2VM332TB5*00C
	3900	64.3×130	0.20	32	47	13.0	ENE2VM392TD0*00C
	4700	64.3×155	0.20	29	43	15.1	ENE2VM472TF5*00C
	5600	76.9×130	0.20	26	37	17.0	ENE2VM562UD0*00C
	6800	76.9×155	0.20	23	34	20.4	ENE2VM682UF5*00C
	8200	76.9×168	0.20	19	28	23.2	ENE2VM822UG8*00C
	10000	76.9×220	0.20	16	24	26.9	ENE2VM103UM0*00C
	12000	91.0×196	0.20	14	22	30.3	ENE2VM123VJ6*00C
15000	91.0×220	0.20	11	18	32.1	ENE2VM153VM0*00C	
400(2G)	1500	51.6×105	0.20	71	101	5.9	ENE2GM152SA5*00C
	2200	51.6×130	0.20	56	81	7.2	ENE2GM222SD0*00C
	3300	64.3×130	0.20	37	55	11.9	ENE2GM332TD0*00C
	3900	76.9×115	0.20	34	49	14.1	ENE2GM392UB5*00C
	4700	76.9×130	0.20	29	43	15.7	ENE2GM472UD0*00C
	5600	76.9×155	0.20	27	40	18.3	ENE2GM562UF5*00C
	6800	76.9×168	0.20	22	34	21.1	ENE2GM682UG8*00C
	8200	91.0×157	0.20	19	29	24.3	ENE2GM822VF7*00C
	10000	91.0×196	0.20	16	23	27.2	ENE2GM103VJ6*00C
	12000	91.0×220	0.20	14	19	30.2	ENE2GM123VM0*00C
450(2W)	1500	51.6×130	0.20	74	108	5.9	ENE2WM152SD0*00C
	2200	64.3×115	0.20	49	78	9.2	ENE2WM222TB5*00C
	3300	64.3×155	0.20	38	49	12.8	ENE2WM332TF5*00C
	3900	64.3×168	0.20	32	41	14.4	ENE2WM392TG8*00C
	4700	76.9×155	0.20	27	39	16.8	ENE2WM472UF5*00C
	5600	76.9×196	0.20	24	35	20.3	ENE2WM562UJ6*00C
	6800	91.0×196	0.20	21	30	23.1	ENE2WM682VJ6*00C
	8200	91.0×196	0.20	18	26	26.6	ENE2WM822VJ6*00C
	10000	91.0×220	0.20	15	21	27.8	ENE2WM103VM0*00C

Note: "*" may be "A" or "B" or "S" or "T".

- A: Ring clip mounting standard design
- B: Threaded stud standard design
- S: Ring clip mounting special design
- T: Threaded stud special design

NT series

- Endurance with ripple current: 3,000 hours at 105°C
- Applications: Uninterruptible power supplies and frequency converters
- Detail specification: IEC 60384-4
- RoHS Compliant



SPECIFICATIONS

Items	Characteristics
Category Temperature Range	-25~+105°C(350~450 V _{dc})
Surge Voltage	1.10* V _R
Rated Capacitance Range	1000~12000μF
Rated Voltage Range	350~450 V _{dc}
Capacitance Tolerance	±20% (M) (at 20°C, 120Hz)
Leakage Current	I=0.02CV [μA] or 5mA, whichever is smaller. Where, I: Max.leakage current (μA), C : Rated capacitance (μF), V : Rated voltage (V) (at 20°C after 5 minutes)
Dissipation Factor (tan δ)	0.20 (at 20°C, 120Hz)
Low Temperature Characteristics	Capacitance Change C(-25°C)/C(+20°C) 0.7 (at 120Hz)
Insulation Resistance	When measured between the terminals shorted each other and the mounting clamp on the insulating sleeve covering the case by using an insulation resistance meter of 500V _{dc} , the insulation resistance shall not be less than 100MΩ.
Insulation Withstanding Voltage	When a voltage of 2,000Vac is applied for 1 minute between the terminals shorted each other and the mounting clamp on the insulating sleeve covering the case, there shall not be electrical damage.
Endurance	The following specifications shall be satisfied when the capacitors are restored to 20°C after DC voltage plus the rated ripple current is applied for 3,000 hours at 105°C.
	Capacitance Change ±20% of the initial value
	D.F. (tan δ) 200% of the initial specified value
Shelf Life	The following specifications shall be satisfied when the capacitors are restored to 20°C after exposing them for 1,000 hours at 105°C without voltage applied.
	Capacitance Change ±20% of the initial value
	D.F. (tan δ) 150% of the initial specified value

DIMENSIONS(Screw-Mount)[mm]

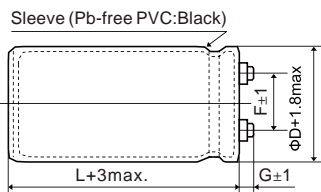

Ø35 to Ø51.6:G=7
Ø64.3 to Ø91:G=6.5

• Mounting Clamp Type:I

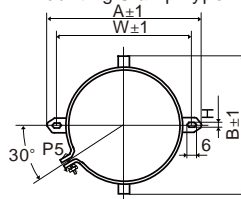

ØD	A	B	W	F
35	58.0	44.0	48.0	12.7
51.6	80.0	62.0	68.0	22.2
64.3	93.0	82.0	81.0	28.5
77	106.0	94.0	93.5	31.7

• Mounting Clamp Type:Y

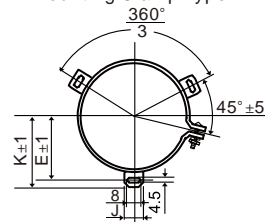

ØD	E	K	J	F
51.6	32.5	35.8	14.0	22.2
64.3	38.4	42.5	14.0	28.5
77	44.5	47.5	14.0	31.7
91	50.8	54.7	14.0	31.7

<Screw specifications>
Plus hexagon-headed screw:
M5x0.8x10 or M6x1.0x12
Maximum screw tightening torque:3.23Nm

* The screw and the mounting clamp are separately supplied and not attached to the product.

PART NUMBERING SYSTEM

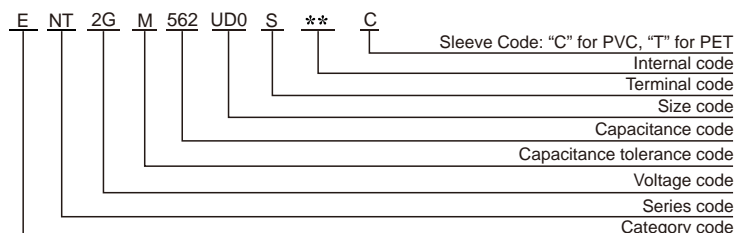

RATED RIPPLE CURRENT MULTIPLIERS

- Frequency Coefficient

Frequency(Hz)	50	120	300	1k	3k
Coefficient	0.8	1.0	1.1	1.3	1.4

The endurance of capacitors is shortened with internal heating produced by ripple current at the rate of halving the lifetime with every 5 or 10°C rise. When long life performance is required in actual use, the rms ripple current has to be reduced.

NT series

■ STANDARD RATINGS

WV (V _{dc})	Cap (μF)	Case size D×L(mm)	tan	ESR typ. 120Hz 20°C m	ESR max. 120Hz 20°C m	Rated ripple current (Arms/105°C,120Hz)	Part Number
350(2V)	1000	51.6×80	0.20	108	157	2.4	ENT2VM102S80*00C
	1500	51.6×80	0.20	79	116	3.0	ENT2VM152S80*00C
	2200	51.6×96	0.20	57	81	4.1	ENT2VM222S96*00C
	3300	64.3×105	0.20	43	59	4.8	ENT2VM332TA5*00C
	3900	64.3×115	0.20	39	54	6.5	ENT2VM392TB5*00C
	4700	64.3×130	0.20	35	48	7.0	ENT2VM472TD0*00C
	5600	76.9×130	0.20	30	40	8.5	ENT2VM562UD0*00C
	6800	76.9×143	0.20	27	36	10.0	ENT2VM682UE3*00C
	8200	76.9×168	0.20	23	31	11.4	ENT2VM822UG8*00C
	10000	91.0×170	0.20	19	28	14.1	ENT2VM103VH0*00C
12000	91.0×220	0.20	17	25	16.2	ENT2VM123VM0*00C	
400(2G)	1000	51.6×80	0.20	109	158	3.0	ENT2GM102S80*00C
	1500	51.6×96	0.20	75	107	3.7	ENT2GM152S96*00C
	2200	64.3×105	0.20	35	76	4.6	ENT2GM222TA5*00C
	3300	64.3×130	0.20	31	53	6.4	ENT2GM332TD0*00C
	3900	76.9×115	0.20	28	46	7.9	ENT2GM392UB5*00C
	4700	76.9×130	0.20	23	40	8.0	ENT2GM472UD0*00C
	5600	76.9×143	0.20	21	36	9.8	ENT2GM562UE3*00C
	6800	76.9×155	0.20	14	31	10.5	ENT2GM682UF5*00C
	8200	91.0×155	0.20	12	30	13.3	ENT2GM822VF5*00C
	10000	91.0×170	0.20	11	23	18.0	ENT2GM103VH0*00C
12000	91.0×196	0.20	10	21	22.6	ENT2GM123VJ6*00C	
450(2W)	1000	51.6×105	0.20	95	153	4.3	ENT2WM102SA5*00C
	1500	51.6×115	0.20	63	102	5.8	ENT2WM152SB5*00C
	2200	64.3×115	0.20	40	70	7.6	ENT2WM222TB5*00C
	3300	76.9×115	0.20	25	48	10.5	ENT2WM332UB5*00C
	3900	76.9×130	0.20	22	42	11.3	ENT2WM392UD0*00C
	4700	76.9×155	0.20	20	40	12.7	ENT2WM472UF5*00C
	5600	91.0×130	0.20	17	36	16.0	ENT2WM562VD0*00C
	6800	91.0×155	0.20	14	32	16.9	ENT2WM682VF5*00C
	8200	91.0×196	0.20	10	22	17.5	ENT2WM822VJ6*00C
	10000	91.0×220	0.20	8	20	18.1	ENT2WM103VM0*00C

Note: "*" may be "A" or "B" or "S" or "T".
A: Ring clip mounting standard design
B: Threaded stud standard design
S: Ring clip mounting special design
T: Threaded stud special design

NF series

- Endurance with ripple current: 5,000 hours at 105°C
- Applications: Professional power supplies, Frequency converters and Traction
- Detail specification: IEC 60384-4
- RoHS Compliant



SPECIFICATIONS

Items	Characteristics
Category Temperature Range	-25~+105°C(350~450 V _{dc})
Surge Voltage	1.10* V _R
Rated Capacitance Range	1000~15000µF
Rated Voltage Range	350~450 V _{dc}
Capacitance Tolerance	±20% (M) (at 20°C, 120Hz)
Leakage Current	I=0.02CV [µA] or 5mA, whichever is smaller. Where, I: Max.leakage current (µA), C : Rated capacitance (µF), V : Rated voltage (V) (at 20°C after 5 minutes)
Dissipation Factor (tan δ)	0.20 (at 20°C, 120Hz)
Low Temperature Characteristics	Capacitance Change C(-25°C)/C(+20°C) 0.7 (at 120Hz)
Insulation Resistance	When measured between the terminals shorted each other and the mounting clamp on the insulating sleeve covering the case by using an insulation resistance meter of 500V _{dc} , the insulation resistance shall not be less than 100MΩ.
Insulation Withstanding Voltage	When a voltage of 2,000Vac is applied for 1 minute between the terminals shorted each other and the mounting clamp on the insulating sleeve covering the case, there shall not be electrical damage.
Endurance	The following specifications shall be satisfied when the capacitors are restored to 20°C after DC voltage plus the rated ripple current is applied for 5,000 hours at 105°C.
	Capacitance Change ±20% of the initial value
	D.F. (tan δ) 200% of the initial specified value
Shelf Life	The following specifications shall be satisfied when the capacitors are restored to 20°C after exposing them for 1,000 hours at 105°C without voltage applied.
	Capacitance Change ±20% of the initial value
	D.F. (tan δ) 150% of the initial specified value
	Leakage Current The initial specified value

DIMENSIONS(Screw-Mount)[mm]

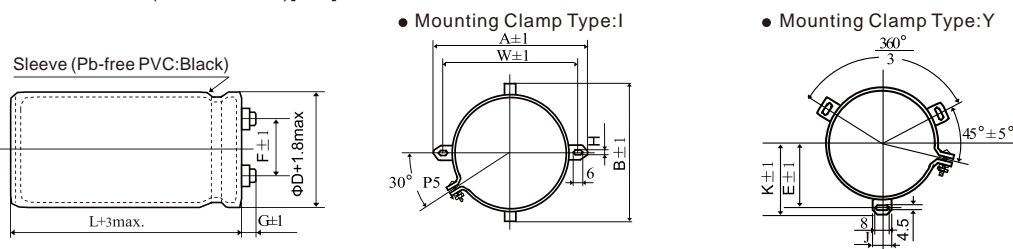

Ø35 to Ø51.6:G=7
Ø64.3 to Ø91:G=6.5

ØD	A	B	W	F
35	58.0	44.0	48.0	12.7
51.6	80.0	62.0	68.0	22.2
64.3	93.0	82.0	81.0	28.5
77	106.0	94.0	93.5	31.7

ØD	E	K	J	F
51.6	32.5	35.8	14.0	22.2
64.3	38.4	42.5	14.0	28.5
77	44.5	47.5	14.0	31.7
91	50.8	54.7	14.0	31.7

<Screw specifications>
Plus hexagon-headed screw:
M5x0.8x10 or M6x1.0x12
Maximum screw tightening torque:3.23Nm

* The screw and the mounting clamp are separately supplied and not attached to the product.

PART NUMBERING SYSTEM

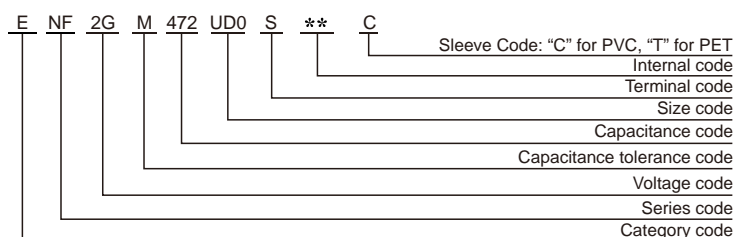

RATED RIPPLE CURRENT MULTIPLIERS

- Frequency Coefficient

Frequency(Hz)	50	120	300	1k	3k
Coefficient	0.8	1.0	1.1	1.3	1.4

The endurance of capacitors is shortened with internal heating produced by ripple current at the rate of halving the lifetime with every 5 or 10°C rise. When long life performance is required in actual use, the rms ripple current has to be reduced.

Screw-mount Terminal Type

NF series

■ STANDARD RATINGS

WV (V _{dc})	Cap (μF)	Case size D×L(mm)	tan	ESR typ. 120Hz 20°C m	ESR max. 120Hz 20°C m	Rated ripple current (Arms/105°C,120Hz)	Part Number
350(2V)	1000	51.6×80	0.20	99	148	4.2	ENF2VM102S80*00C
	1500	51.6×96	0.20	71	107	5.3	ENF2VM152S96*00C
	2200	51.6×105	0.20	49	72	7.2	ENF2VM222SA5*00C
	3300	64.3×115	0.20	34	50	10.0	ENF2VM332TB5*00C
	3900	64.3×130	0.20	30	45	11.7	ENF2VM392TD0*00C
	4700	64.3×143	0.20	26	39	12.6	ENF2VM472TE3*00C
	5600	76.9×143	0.20	21	32	14.9	ENF2VM562UE3*00C
	6800	76.9×168	0.20	19	28	17.0	ENF2VM682UG8*00C
	8200	76.9×196	0.20	15	25	19.8	ENF2VM822UJ6*00C
	10000	76.9×220	0.20	13	20	23.2	ENF2VM103UM0*00C
	12000	91×196	0.20	11	16	26.9	ENF2VM123VJ6*00C
15000	91×220	0.20	9	13	30.9	ENF2VM153VM0*00C	
400(2G)	1000	51.6×80	0.20	101	151	4.4	ENF2GM102S80*00C
	1500	51.6×96	0.20	67	98	5.9	ENF2GM152S96*00C
	2200	64.3×105	0.20	48	68	7.4	ENF2GM222TA5*00C
	3300	64.3×130	0.20	30	45	10.5	ENF2GM332TD0*00C
	3900	76.9×115	0.20	27	39	11.3	ENF2GM392UB5*00C
	4700	76.9×130	0.20	22	32	14.0	ENF2GM472UD0*00C
	5600	76.9×143	0.20	20	28	15.1	ENF2GM562UE3*00C
	6800	76.9×168	0.20	17	23	18.0	ENF2GM682UG8*00C
	8200	76.9×196	0.20	15	21	21.3	ENF2GM822UJ6*00C
	10000	76.9×220	0.20	13	19	22.1	ENF2GM103UM0*00C
	12000	91×220	0.20	9	13	27.6	ENF2GM123VM0*00C
450(2W)	1000	51.6×105	0.20	97	145	4.3	ENF2WM102SA5*00C
	1500	51.6×130	0.20	65	97	6.1	ENF2WM152SD0*00C
	2200	64.3×115	0.20	45	67	7.8	ENF2WM222TB5*00C
	3300	76.9×130	0.20	29	43	10.8	ENF2WM332UD0*00C
	3900	76.9×143	0.20	25	37	12.9	ENF2WM392UE3*00C
	4700	76.9×168	0.20	22	32	14.3	ENF2WM472UG8*00C
	5600	76.9×196	0.20	19	28	14.7	ENF2WM562UJ6*00C
	6800	76.9×220	0.20	16	23	18.1	ENF2WM682UM0*00C
	8200	91×196	0.20	12	17	19.7	ENF2WM822VJ6*00C
	10000	91×220	0.20	10	15	23.5	ENF2WM103VM0*00C

Note: "*" may be "A" or "B" or "S" or "T".
A: Ring clip mounting standard design
B: Threaded stud standard design
S: Ring clip mounting special design
T: Threaded stud special design

NK series

- Endurance with ripple current: 5,000 hours at 105°C
- High ripple and long life series
- Detail specification: IEC 60384-4
- RoHS Compliant



SPECIFICATIONS

Items	Characteristics
Category Temperature Range	-25~+105°C(350~450 V _{dc})
Surge Voltage	1.10* V _R
Rated Capacitance Range	1000~15000µF
Rated Voltage Range	350~450 V _{dc}
Capacitance Tolerance	±20% (M) (at 20°C, 120Hz)
Leakage Current	I=0.02CV [µA] or 5mA, whichever is smaller. Where, I: Max.leakage current (µA), C : Rated capacitance (µF), V : Rated voltage (V) (at 20°C after 5 minutes)
Dissipation Factor (tan δ)	0.20 (at 20°C, 120Hz)
Low Temperature Characteristics	Capacitance Change C(-25°C)/C(+20°C) 0.7 (at 120Hz)
Insulation Resistance	When measured between the terminals shorted each other and the mounting clamp on the insulating sleeve covering the case by using an insulation resistance meter of 500V _{dc} , the insulation resistance shall not be less than 100MΩ.
Insulation Withstanding Voltage	When a voltage of 2,000Vac is applied for 1 minute between the terminals shorted each other and the mounting clamp on the insulating sleeve covering the case, there shall not be electrical damage.
Endurance	The following specifications shall be satisfied when the capacitors are restored to 20°C after DC voltage plus the rated ripple current is applied for 5,000 hours at 105°C.
	Capacitance Change ±20% of the initial value
	D.F. (tan δ) 200% of the initial specified value
	Leakage Current The initial specified value
Shelf Life	The following specifications shall be satisfied when the capacitors are restored to 20°C after exposing them for 1,000 hours at 105°C without voltage applied.
	Capacitance Change ±20% of the initial value
	D.F. (tan δ) 150% of the initial specified value
	Leakage Current The initial specified value

DIMENSIONS(Screw-Mount)[mm]

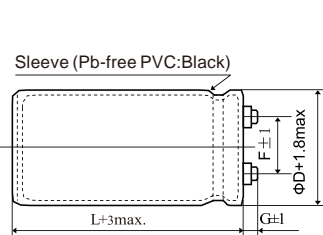

Ø35 to Ø51.6:G=7
Ø64.3 to Ø91:G=6.5

● Mounting Clamp Type:I

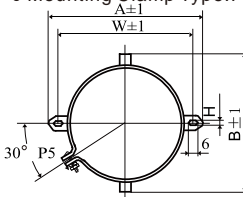

ØD	A	B	W	F
35	58.0	44.0	48.0	12.7
51.6	80.0	62.0	68.0	22.2
64.3	93.0	82.0	81.0	28.5
77	106.0	94.0	93.5	31.7

● Mounting Clamp Type:Y

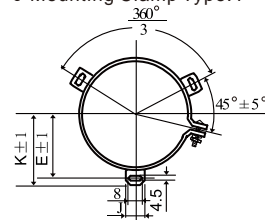

ØD	E	K	J	F
51.6	32.5	35.8	14.0	22.2
64.3	38.4	42.5	14.0	28.5
77	44.5	47.5	14.0	31.7
91	50.8	54.7	14.0	31.7

<Screw specifications>
Plus hexagon-headed screw:
M5x0.8x10 or M6x1.0x12
Maximum screw tightening torque:3.23Nm

* The screw and the mounting clamp are separately supplied and not attached to the product.

PART NUMBERING SYSTEM

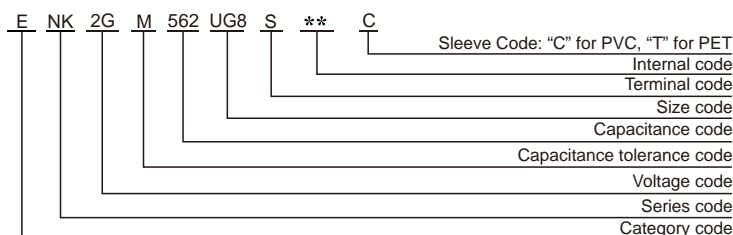

RATED RIPPLE CURRENT MULTIPLIERS

- Frequency Coefficient

Frequency(Hz)	50	120	300	1k	3k
Coefficient	0.8	1.0	1.1	1.3	1.4

The endurance of capacitors is shortened with internal heating produced by ripple current at the rate of halving the lifetime with every 5 or 10°C rise. When long life performance is required in actual use, the rms ripple current has to be reduced.

NK series

■ STANDARD RATINGS

WV (V _{dc})	Cap (μF)	Case size D×L(mm)	tan	ESR typ. 120Hz 20°C m	ESR max. 120Hz 20°C m	Rated ripple current (Arms/105°C,120Hz)	Part Number
350(2V)	1000	51.6×80	0.20	88	140	5.3	ENK2VM102S80*00C
	1500	51.6×80	0.20	65	99	7.9	ENK2VM152S80*00C
	2200	51.6×105	0.20	40	68	10.2	ENK2VM222SA5*00C
	3300	64.3×115	0.20	26	45	14.5	ENK2VM332TB5*00C
	3900	64.3×130	0.20	23	41	16.4	ENK2VM392TD0*00C
	4700	64.3×155	0.20	20	36	19.2	ENK2VM472TF5*00C
	5600	76.9×143	0.20	18	29	21.9	ENK2VM562UE3*00C
	6800	76.9×168	0.20	15	25	26.3	ENK2VM682UG8*00C
	8200	76.9×196	0.20	13	23	30.2	ENK2VM822UJ6*00C
	10000	76.9×220	0.20	11	18	33.7	ENK2VM103UM0*00C
	12000	100×196	0.20	10	14	38.0	ENK2VM123AJ6*00C
	15000	100×250	0.20	8	12	47.9	ENK2VM153AP0*00C
400(2G)	1000	51.6×80	0.20	90	141	5.2	ENK2GM102S80*00C
	1500	51.6×96	0.20	61	92	7.1	ENK2GM152S96*00C
	2200	64.3×105	0.20	45	61	10.4	ENK2GM222TA5*00C
	3300	64.3×130	0.20	29	42	15.2	ENK2GM332TD0*00C
	3900	76.9×130	0.20	25	35	18.0	ENK2GM392UD0*00C
	4700	76.9×143	0.20	20	29	20.6	ENK2GM472UE3*00C
	5600	76.9×168	0.20	19	26	23.9	ENK2GM562UG8*00C
	6800	76.9×196	0.20	16	21	27.5	ENK2GM682UJ6*00C
	8200	91×196	0.20	13	19	30.8	ENK2GM822VJ6*00C
	10000	100×196	0.20	11	17	34.9	ENK2GM103AJ6*00C
	12000	100×220	0.20	7	11	40	ENK2GM123AM0*00C
	450(2W)	1000	51.6×105	0.20	87	138	5.3
1500		51.6×115	0.20	60	92	7.1	ENK2WM152SB5*00C
2200		64.3×115	0.20	41	62	11.9	ENK2WM222TB5*00C
3300		76.9×130	0.20	25	39	16.7	ENK2WM332UD0*00C
3900		76.9×143	0.20	23	34	18.9	ENK2WM392UE3*00C
4700		76.9×168	0.20	20	29	21.9	ENK2WM472UG8*00C
5600		76.9×196	0.20	17	26	24.4	ENK2WM562UJ6*00C
6800		76.9×220	0.20	13	20	28.0	ENK2WM682UM0*00C
8200		91×196	0.20	10	15	32.3	ENK2WM822VJ6*00C
10000		100×220	0.20	8	13	36.9	ENK2WM103AM0*00C

Note: "*" may be "A" or "B" or "S" or "T".

- A: Ring clip mounting standard design
- B: Threaded stud standard design
- S: Ring clip mounting special design
- T: Threaded stud special design

X-ON Electronics

Largest Supplier of Electrical and Electronic Components

Click to view similar products for [Aluminium Electrolytic Capacitors - Radial Leaded](#) category:

Click to view products by [Aishi](#) manufacturer:

Other Similar products are found below :

[LXY50VB4.7M-5X11](#) [RFO-100V471MJ7P#](#) [ECE-A1EGE220](#) [B41041A7226M8](#) [B41044A7157M6](#) [NCD681K10KVY5PF](#)

[NEV1000M25EF-BULK](#) [NEV100M35DC](#) [NEV100M63DE](#) [NEV220M25DD-BULK](#) [NEV.33M100AA](#) [NEV4700M50HB](#) [NEV.47M100AA](#)

[NEVH1.0M250AB](#) [NEVH3.3M250BB](#) [NEVH3.3M450CC](#) [KME50VB100M-8X11.5](#) [SG220M1CSA-0407](#) [ES5107M016AE1DA](#)

[ESMG160ETD102MJ16S](#) [ESX472M16B](#) [227RZS050M](#) [476CKH100MSA](#) [477RZS050M](#) [B41793A9108Q1](#) [UVX1V101KPA1FA](#)

[UVX1V222MHA1CA](#) [KME25VB100M-6.3X11](#) [VTL100S10](#) [VTL470S10](#) [VTL470S16A](#) [511D336M250EK5D](#) [052687X](#) [ECE-A1CF471](#)

[NRE-S560M16V6.3X7TBSTF](#) [RGA221M1CTA-0611G](#) [ERZA630VHN182UP54N](#) [UPL1A331MPH](#) [NEV1000M6.3DE](#) [NEV100M16CB](#)

[NEV100M50DD-BULK](#) [NEV2200M16FF](#) [NEV220M50EE](#) [NEV2.2M50AA](#) [NEV330M63EF](#) [NEV4700M35HI](#) [NEV4.7M100BA](#)

[NEV47M16BA](#) [NEV47M50CB-BULK](#) [NEVH1.0M350AB](#)