

UPA30 / UPA41

DIN 96x96 multifunction meter for energy monitoring

- DIN 96x96 compact version
- Main electrical parameters measured and displayed for a cost-effective consumption analysis
- For current transformers (not included)
- Programmable VT
- Wiring error detection
- Display of predictive power values
- Available optional plug-in modules for communication, inputs/outputs, temperature
- Active energy class 0,5 S according to IEC 62053-22
- Compliant with IEC 61557-12, the reference standard for PMDs (Performance Metering & monitoring Devices)
- UL listed product - UL no. E231725 (only UPA30)



» General features

UPA30 and UPA41 are performance metering & monitoring devices that provide all of the measurements needed to complete energy efficiency projects and to assure the monitoring of electrical distribution. It is particularly suitable for consumption analysis and control, with an excellent quality/price ratio.

With its large backlit multiple-display screen with 6 hot keys, the instrument is easy to use. Furthermore, it is provided with a correction function for CT wiring errors.

The instrument can be equipped with additional modules that give flexibility throughout the service life of the product. Modules for RS485 communication, additional digital or analogue inputs/outputs and temperature detection can be used to increase its range of functionality.

The instrument is compliant with IEC 61557-12, the reference standard for PMDs (Performance Metering & monitoring Devices). It guarantees performance levels and satisfactory performance from the PMDs under the environmental conditions typical of industrial and tertiary applications.

» Benefits

- User-friendly operation
- Detection of wiring errors
- Display of predictive power values
- Flexibility throughout the service life of the product with additional modules
- Compliant with IEC 61557-12
- Active energy class 0,5 S according to IEC 62053-22
- UL listed product

» Applications

- Industry
- Building
- Infrastructures

» Related Products

- 485-MDB-30-41
- 2PULSE-30-41
- 2DO-2DI-30-41
- 2AO-30-41
- TEMP-30-41

» Measurements

INSTANTANEOUS VALUES	
VOLTAGE	$V_{L1-N} - V_{L2-N} - V_{L3-N} - V_{L1-L2} - V_{L2-L3} - V_{L3-L1} - V_{\Sigma}$ [V]
CURRENT	$I_{L1} - I_{L2} - I_{L3} - I_N - I_{\Sigma}$ [A]
ACTIVE POWER	$P_{L1} - P_{L2} - P_{L3} - P_{\Sigma}$ [W]
REACTIVE POWER	$Q_{L1} - Q_{L2} - Q_{L3} - Q_{\Sigma}$ [var]
APPARENT POWER	$S_{L1} - S_{L2} - S_{L3} - S_{\Sigma}$ [VA]
POWER FACTOR	$PF_{L1} - PF_{L2} - PF_{L3} - PF_{\Sigma}$
K FACTOR	
VOLTAGE THD	$THDV_{L1} - THDV_{L2} - THDV_{L3} - THDV_{L1,L2} - THDV_{L2,L3} - THDV_{L3,L1}$ [M]
CURRENT THD	$THDA_{L1} - THDA_{L2} - THDA_{L3} - THDA_N$ [A]
FREQUENCY	f [Hz]
AVERAGE VALUES (AVG)	
AVG VOLTAGE	$V_{L1-NAVG} - V_{L2-NAVG} - V_{L3-NAVG} - V_{L1-L2AVG} - V_{L2-L3AVG} - V_{L3-L1AVG}$ [V]
AVG CURRENT	$I_{L1AVG} - I_{L2AVG} - I_{L3AVG} - I_{NAVG}$ [A]
AVG POWER FACTOR	$PF_{\Sigma AVG}$
AVG FREQUENCY	f_{AVG} [Hz]
MAX AVERAGE VALUES (MAX AVG)	
MAX AVG VOLTAGE	$V_{L1-NMAXAVG} - V_{L2-NMAXAVG} - V_{L3-NMAXAVG} - V_{L1-L2MAXAVG} - V_{L2-L3MAXAVG} - V_{L3-L1MAXAVG}$ [V]
MAX AVG CURRENT	$I_{L1MAXAVG} - I_{L2MAXAVG} - I_{L3MAXAVG} - I_{NMAXAVG}$ [A]
MAX AVG ACTIVE POWER	$P_{\Sigma MAXAVG}$ [W]
MAX AVG REACTIVE POWER	$Q_{\Sigma MAXAVG}$ [var]
MAX AVG APPARENT POWER	$S_{\Sigma MAXAVG}$ [VA]
MAX AVG POWER FACTOR	$PF_{\Sigma MAXAVG}$
MAX AVG FREQUENCY	f_{MAXAVG} [Hz]
PREDICTIVE VALUES	
PREDECTIVE ACTIVE POWER	$P_{\Sigma PRED}$ [W]
PREDECTIVE REACTIVE POWER	$Q_{\Sigma PRED}$ [var]
PREDECTIVE APPARENT POWER	$S_{\Sigma PRED}$ [VA]
COUNTERS	
ACTIVE ENERGY	+/-kWh
REACTIVE ENERGY	+/-kvarh
APPARENT ENERGY	kVAh
TIMETABLE	
HARMONIC ANALYSIS UP TO 63 rd on communication, UP TO 25 th on display	
VOLTAGE HARMONICS	$V_{L1-N} - V_{L2-N} - V_{L3-N} - V_{L1-L2} - V_{L2-L3} - V_{L3-L1}$ [V]
CURRENT HARMONICS	$I_{L1} - I_{L2} - I_{L3} - I_N$ [A]

Please note that:

- UPA30 provides a neutral current (N) value CALCULATED automatically
- UPA41 provides a neutral current (N) value MEASURED thanks to the permanent module

» Technical drawing

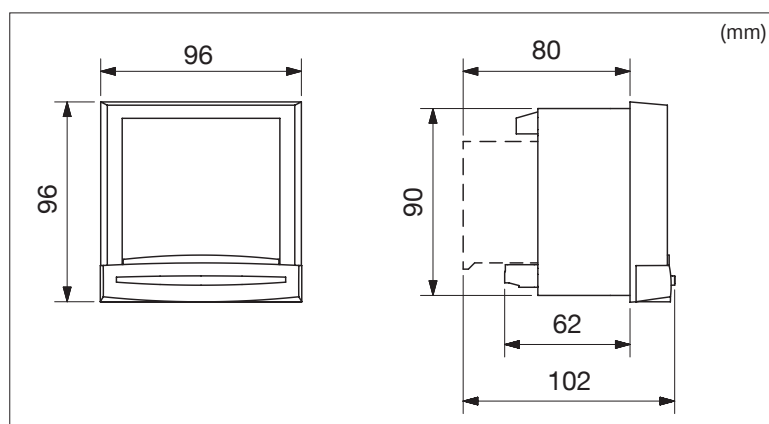

» Case

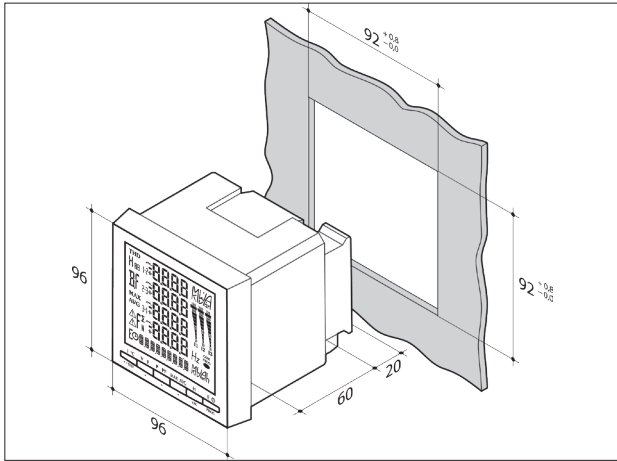

Type	Panel mounting
Dimensions W x H x D	96 x 96 x 60 mm
Case degree of protection	IP30
Front degree of protection	IP52
Display type	Backlit LCD display
Type of terminal strips	Fixed or detachable
Section of connection for voltages and other terminals	0,2 ... 2.5 mm ²
Section of connection for currents	0.5 ... 6 mm ²
Weight	400 g

» Plug-in modules to be combined to UPA30/UPA41

Available plug-in modules	Description
485-MDB-30-41	RS485 communication with MODBUS protocol (speed up to 38400 baud)
2PULSE-30-41	2 configurable pulse outputs (type, weight and run) on \pm kwh, \pm kvarh and kVAh
2DO-2DI-30-41	2 digital inputs for pulse counting and 2 digital outputs which can be allocated to: <ul style="list-style-type: none"> monitoring: $I_{L1}, I_{L2}, I_{L3}, I_N, V_{L1-N}, V_{L2-N}, V_{L3-N}, V_{L1-L2}, V_{L2-L3}, V_{L3-L1}, f, \pm P, \pm Q, S, PF, THDA_{L1}, THDA_{L2}, THDA_{L3}, THDA_N, THDV_{L1}, THDV_{L2}, THDV_{L3}, THDV_{L1-L2}, THDV_{L2-L3}, THDV_{L3-L1}, P_{PRED}, Q_{PRED}, S_{PRED}, T^{\circ}C$ internal, $T^{\circ}C1$ external, $T^{\circ}C2$ external, $T^{\circ}C3$ external, time counter remote control timed remote control
2AO-30-41	2 analog outputs which can be allocated to: <ul style="list-style-type: none"> $I_{L1}, I_{L2}, I_{L3}, I_N, V_{L1-N}, V_{L2-N}, V_{L3-N}, V_{L1-L2}, V_{L2-L3}, V_{L3-L1}, f, \pm P, \pm Q, S, PF, I_2, V_2, P_{PRED}, Q_{PRED}, S_{PRED}, T^{\circ}C$ internal, $T^{\circ}C1$ external, $T^{\circ}C2$ external, $T^{\circ}C3$ external, 30 VDC power supply
TEMP-30-41	Detection of internal temperature ($T^{\circ}C$ internal) and up to 3 external temperature through PT100 probes ($T^{\circ}C1$ external, $T^{\circ}C2$ external, $T^{\circ}C3$ external)

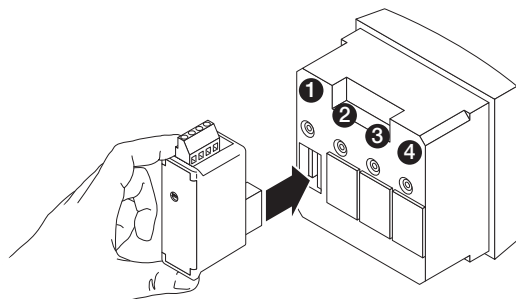

Module name	Max module number	1 <small>▲ only for UPA30</small>	2	3	4
485-MDB-30-41	1	x	x	x	x
2PULSE-30-41	4	x	x	x	x
2DO-2DI-30-41	3	x	x	x	x
2AO-30-41	2	x*	x*	x*	x*
TEMP-30-41	1		x	x	

* If two modules are used they must be placed on slots 1 and 2

Please note that UPA41 is provided with a permanent module on slot 1. This module allows to measure the neutral current (N) and it cannot be removed.

» Specifications

UPA30/UPA41

Measurement of currents on insulated inputs (TRMS)	
Via CT primary	9,999 A
Via CT secondary	1 or 5 A
Measurement range	0 ... 11 kA
Input consumption	≤ 0,1 VA
Measurement updating period	1 s
Accuracy	0.2%
Permanent overload	6 A
Intermittent overload	10 In for 1 s
Voltage measurements (TRMS)	
Direct measurement between phases	50 to 1039 VAC
Direct measurement between phase and neutral	28 to 600 VAC
VT primary measurement	500,000 VAC
VT secondary measurement	60, 100, 110, 173, 190 VAC
Frequency	50 / 60 Hz
Input consumption	≤ 0,1 VA
Measurement updating period	1 s
Accuracy	0.2%
Current - voltage product	
Limitation for CT 1 A	10,000,000
Limitation for CT 5 A	10,000,000
Power measurement	
Measurement updating period	1 s
Accuracy	0.5%
Power factor measurement	
Measurement updating period	1 s
Accuracy	0.5%
Frequency measurement	
Measurement range	45 ... 65 Hz
Measurement updating period	1 s
Accuracy	0.1%
Energy accuracy	
Active (according to IEC 62053-22)	Class 0.5 S
Reactive (according to IEC 62053-23)	Class 2
Auxiliary power supply	
Alternative voltage	110 ... 400 VAC
AC tolerance	± 10 %
Direct current	120 ... 350 VDC / 12 ... 48 VDC
DC tolerance	± 20 % / - 6 ... + 20 %
Frequency	50 / 60 Hz
Power consumption	≤ 10 VA
Operating conditions	
Operating temperature range	-10 to +55°C
Storage temperature	-20 to 85°C
Relative humidity	95%

Optional plug-in modules

Module 2 inputs - 2 outputs: outputs (alarms / control)	
Number of relays	2(1)
Type	250 VAC - 5 A - 1150 VA
Module 2 inputs - 2 outputs: optical coupler inputs	
Number	2(1)
Power supply	10 ... 30 VDC
Minimum width of signal	10 ms
Minimum length between 2 pulses	18 ms
Type	Optical couplers
Pulse output module	
Number of relays	2
Type	100 VDC - 0.5 A - 10 VA
Max. number of manoeuvres	≤ 108
Analogue output module	
Number of outputs	2(2)
Type	Insulated
Scale	0 / 4 ... 20 mA
Load resistance	600 Ω
Maximum current	30 mA
MODBUS communication module	
Link	RS485
Type	2 to 3 half duplex wires
Protocol	MODBUS® RTU
MODBUS® speed	4800 to 38400 baud
Temperature module (inputs)	
Type	PT100
Connection	2, 3 or 4 wires
Dynamic	- 20°C ... 150°C
Accuracy	± 1 digit
Maximum length	300 cm

ORDER CODE	MODEL	POWER SUPPLY	MEASURED NEUTRAL CURRENT	CERTIFICATION
	Name	Auxiliary	Permanent module	UL
UPA30				
1214.0001.0001	UPA30	110...400VAC/120...350VDC		●
1214.0002.0001	UPA30	12...48VDC		●
UPA41				
1215.0001.0001	UPA41	110...400VAC/120...350VDC	●	
1215.0002.0001	UPA41	12...48VDC	●	

ORDER CODE	MODEL	TYPE	CERTIFICATION
	Name	Description	UL
PLUG-IN MODULES FOR UPA30/UPA41			
1216.0004.0001	485-MDB-30-41	RS485 Modbus communication	●
1216.0005.0001	2PULSE-30-41	1 digital output configurable for pulse	●
1216.0006.0001	2DO-2DI-30-41	2 digital outputs configurable for pulses/alarms, 2 digital inputs	●
1216.0007.0001	2AO-30-41	2 analog output	●
1216.0008.0001	TEMP-30-41	Temperature detection	
ACCESSORIES FOR TEMP-30-41 MODULE			
7502.0004.0001	PT100 screw	PT100 temperature probe, M6 screw	
7502.0005.0001	PT100 lug	PT100 temperature probe, M6 lug	
ACCESSORIES FOR UPA30/UPA41			
7502.0006.0001	ADAPT96_144	Integration kit to adapt 144mm cutout to 96mm instrument	

NOTE: Subject to change without notice



algodue
ELETTRONICA

Innovative Electronic Systems

Via P. Gobetti, 16/F - 28014 Maggiora (NO) - Italy - Tel.: +39 0322 89307

sales@algodue.it - www.algodue.com

72PG01_2_201905_5

X-ON Electronics

Largest Supplier of Electrical and Electronic Components

Click to view similar products for [ALGODUE](#) manufacturer:

Other Similar products are found below :

[1101.0005.0001](#) [1109.0004.0001](#) [1107.0011.0001](#) [1107.0012.0001](#) [1107.0005.0001](#) [1107.0007.0001](#) [1107.0001.0001](#) [1107.0003.0001](#)

[1104.0011.0001](#) [1104.0003.0001](#) [1104.0007.0001](#) [1208.0002.0001](#) [1211.0001.0001](#) [1211.0002.0001](#) [1101.0003.0001](#) [1109.0001.0001](#)

[1104.0005.0001](#)