

TO-92 Plastic-Encapsulate Transistors

ALJB772P01 PNP Transistors

Features

- Low speed switching

Marking: ALJB772P01

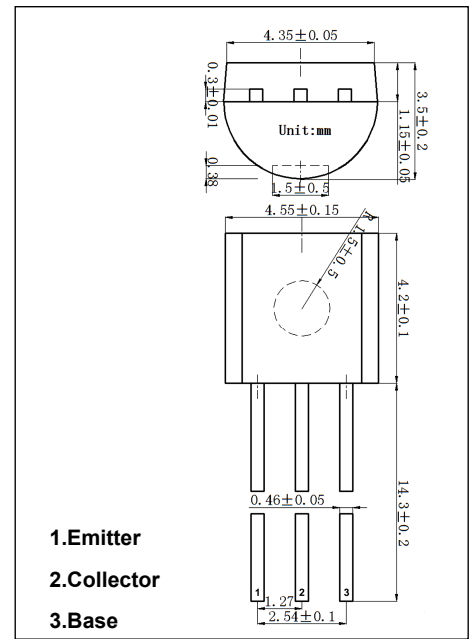

Maximum Ratings (T_a=25°C unless otherwise noted)

Symbol	Parameter	Value	Unit
V _{CB0}	Collector Base Voltage	-40	V
V _{CE0}	Collector Emitter Voltage	-30	V
V _{EBO}	Emitter Base Voltage	-6	V
I _c	Collector Current	-2	A
P _c	Collector Power Dissipation	625	mW
R _{θJA}	Thermal Resistance From Junction To Ambient	200	°C/W
T _j	Junction Temperature	150	°C
T _{stg}	Storage Temperature	- 55 to +150	°C

Electrical Characteristics (T_a=25°C unless otherwise specified)

Symbol	Parameter	Test Conditions	Min	Typ	Max	Unit
V _{(BR)CBO}	Collector-base breakdown voltage	I _c =-100μA, I _E =0	-40			V
V _{(BR)CEO}	Collector-emitter breakdown voltage	I _c =-10mA, I _B =0	-30			V
V _{(BR)EBO}	Emitter-base breakdown voltage	I _E =-100μA, I _c =0	-6			V
I _{cBO}	Collector cut-off current	V _{CB} =-40V, I _E =0			-1	μA
I _{cEO}	Collector cut-off current	V _{CE} =-30V, I _B =0			-10	μA
I _{EBO}	Emitter cut-off current	V _{EB} =-6V, I _c =0			-1	μA
h _{FE(1)}	DC current gain	V _{CE} =-5V, I _c =-1mA	60			
h _{FE(1)}		V _{CE} =-2V, I _c =-1A	60		400	
V _{CE(sat)}	Collector-emitter saturation voltage	I _c =-2A, I _B =-0.2A			-0.5	V
V _{BE(sat)}	Base-emitter saturation voltage	I _c =-2A, I _B =-0.2A			-1.5	V
f _T	Transition frequency	V _{CE} =-5V, I _c =-0.1A, f=10MHz	50	80		MHz

Classification OF h_{FE(1)}

Rank	R	O	Y	GR
Range	60-120	100-200	160-320	200-400

Typical Characteristics

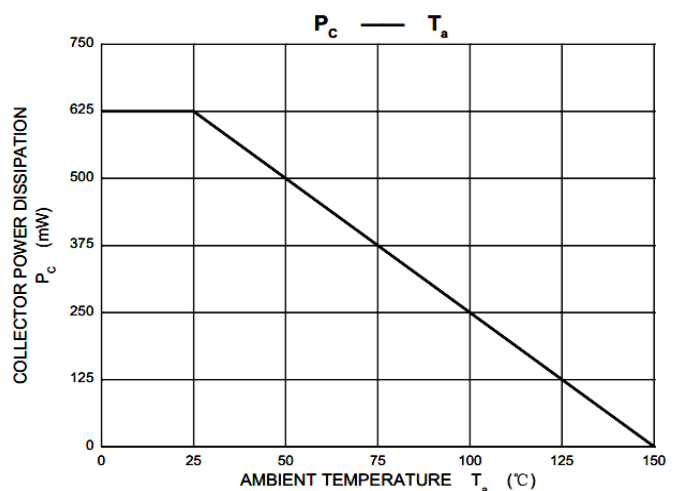
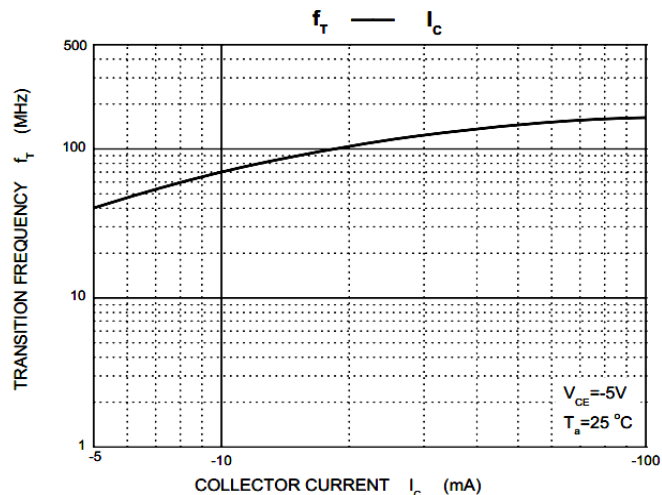
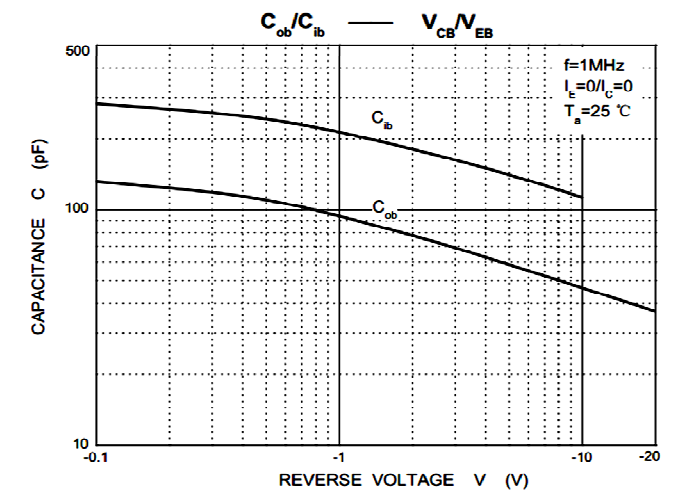
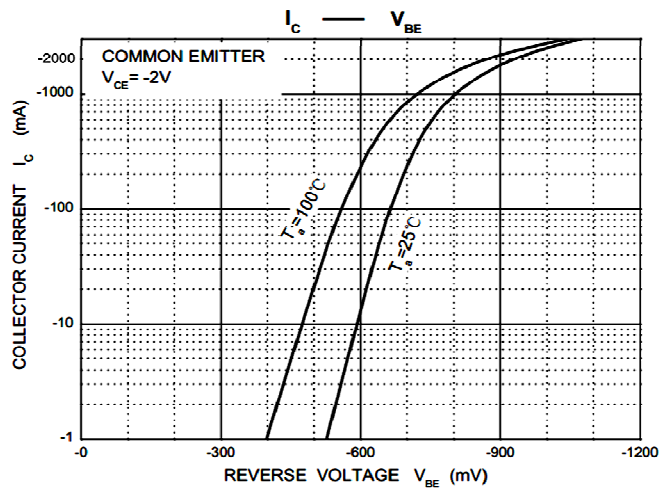
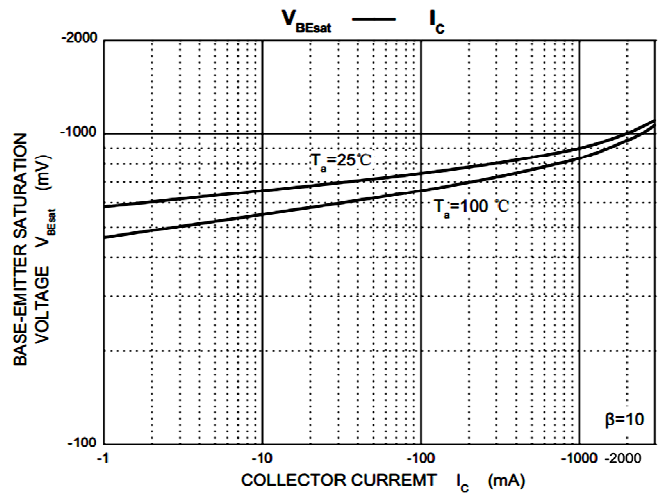
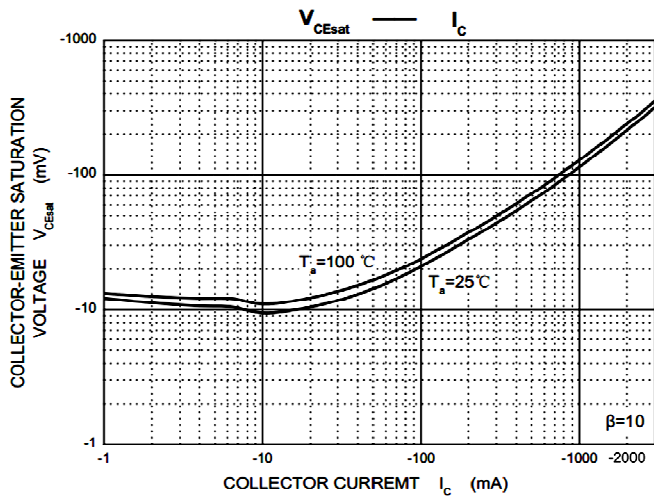
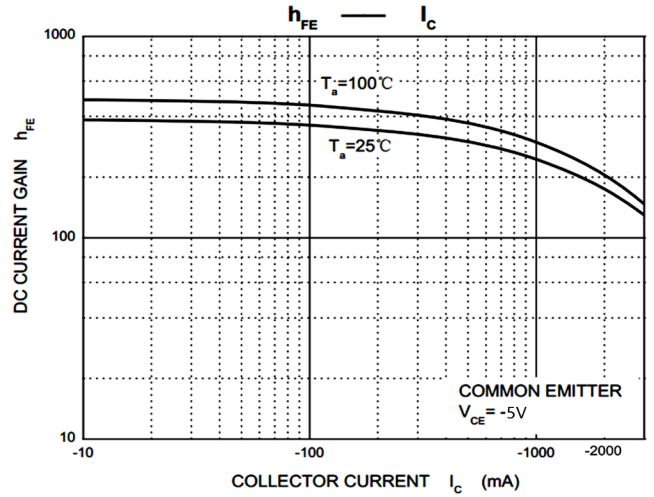
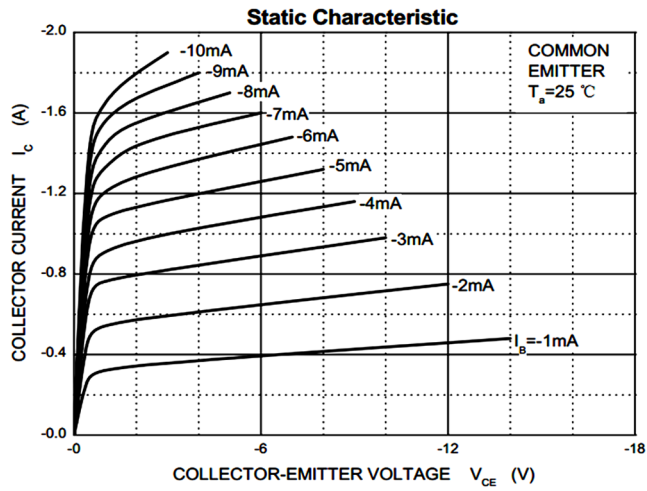

X-ON Electronics

Largest Supplier of Electrical and Electronic Components

Click to view similar products for [Bipolar Transistors - BJT category](#):

Click to view products by [ALJ manufacturer](#):

Other Similar products are found below :

[BC559C](#) [MCH4017-TL-H](#) [MMBT-2369-TR](#) [BC546/116](#) [NJVMJD148T4G](#) [NTE16](#) [NTE195A](#) [IMX9T110](#) [2N4401-A](#) [2N6728](#) [2SA1419T-TD-H](#) [2SB1204S-TL-E](#) [2SC5488A-TL-H](#) [FMC5AT148](#) [2N2369ADCSM](#) [2N2907A](#) [2N3904-NS](#) [2N5769](#) [2SC4618TLN](#) [CPH6501-TL-E](#) [BC856BW-13-F](#) [US6T6TR](#) [BAX18/A52R](#) [BC556/112](#) [IMZ2AT108](#) [MMST8098T146](#) [MCH6102-TL-E](#) [2N3879](#) [30A02MH-TL-E](#) [NTE13](#) [NTE282](#) [NTE323](#) [NTE350](#) [NTE81](#) [JANTX2N2920L](#) [JANSR2N2907AUB](#) [CMLT3946EG TR](#) [SNSS40600CF8T1G](#) [CMLT3906EG TR](#) [GRP-DATA-JANS2N2907AUB](#) [GRP-DATA-JANS2N2222AUA](#) [MMDT3946FL3-7](#) [2N4240](#) [JANS2N3019](#) [MSB30KH-13](#) [2N2221AUB](#) [2SD1815T-TL-E](#) [2N6678](#) [2N2907Ae4](#) [JAN2N3507](#)