



## SOT-23-3L Plastic-Encapsulate MOSFETS

### A03407 P-Channel Enhancement Mode Field Effect Transistor

#### General Description

The 3407 uses advanced trench technology to provide excellent  $R_{DS(on)}$  with low gate charge. This device is suitable for use as a load switch or in PWM applications.

#### Maximum ratings (Ta=25°C unless otherwise noted)

Parameter	Symbol	Value	Units
Drain-Source voltage	$V_{DS}$	-30	V
Gate-Source Voltage	$V_{GS}$	$\pm 20$	V
Continuous Drain Current	$I_D$	-4.6	A
Drain Current-Pulsed	$I_{DM}$	-20	A
Power Dissipation	$P_D$	1.5	W
Thermal Resistance from Junction to Ambient	$R_{\theta JA}$	84	°C/W
Junction Temperature	$T_J$	150	°C
Storage Temperature	$T_{STG}$	-55~ +150	°C

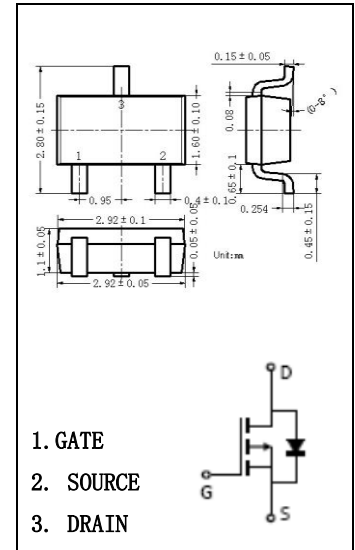

#### Electrical characteristics (Ta=25°C unless otherwise noted)

Parameter	Symbol	Test Condition	Min	Typ	Max	Unit
<b>Static characteristics</b>						
Drain-source breakdown voltage	$V_{(BR) DSS}$	$V_{GS} = 0V, I_D = -250\mu A$	-30			V
Zero gate voltage drain current	$I_{DSS}$	$V_{DS} = -24V, V_{GS} = 0V$			-1	$\mu A$
Gate -source leakage current	$I_{GSS}$	$V_{GS} = \pm 20V, V_{DS} = 0V$			$\pm 100$	nA
Drain-source on-resistance (note 1)	$R_{DS(on)}$	$V_{GS} = -10V, I_D = -4.1A$		55	60	m $\Omega$
		$V_{GS} = -4.5V, I_D = -3A$		75	87	m $\Omega$
Forward transconductance (note 1)	$g_{FS}$	$V_{DS} = -5V, I_D = -4A$	5.5			S
Gate threshold voltage	$V_{GS(th)}$	$V_{DS} = V_{GS}, I_D = -250\mu A$	-1	1.5	-3	V
Diode forward voltage (note 1)	$V_{SD}$	$I_S = -1A, V_{GS} = 0V$			-1	V
<b>Dynamic characteristics (note 2)</b>						
Input capacitance	$C_{iss}$	$V_{DS} = -15V, V_{GS} = 0V, f = 1MHz$		700		pF
Output capacitance	$C_{oss}$			120		pF
Reverse transfer capacitance	$C_{rss}$			75		pF
<b>Switching characteristics (note 2)</b>						
Turn-on delay time	$t_{d(on)}$	$V_{GS} = -10V, V_{DS} = -15V, R_L = 3.6\Omega, R_{GEN} = 3\Omega$		8.6		ns
Turn-on rise time	$t_r$			5.0		ns
Turn-off delay time	$t_{d(off)}$			28.2		ns
Turn-off fall time	$t_f$			13.5		ns

#### Notes:

1. Pulse test: Pulse width  $\leq 300\mu s$ , Duty cycle  $\leq 2\%$ .
2. These parameter have no way to verify.

# Typical Characteristics

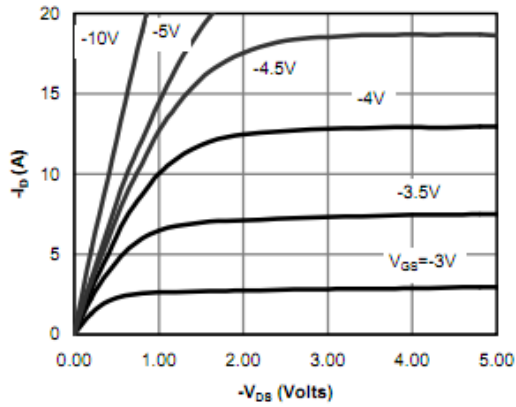

Figure 1: On-Region Characteristics

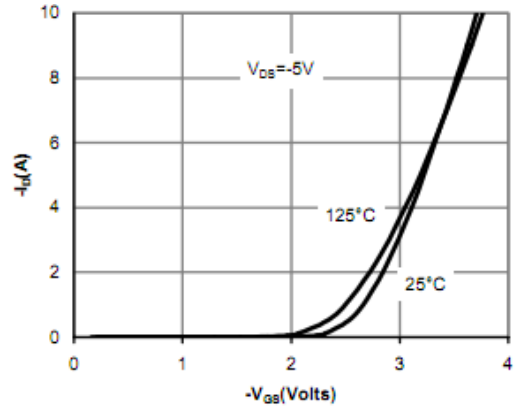

Figure 2: Transfer Characteristics

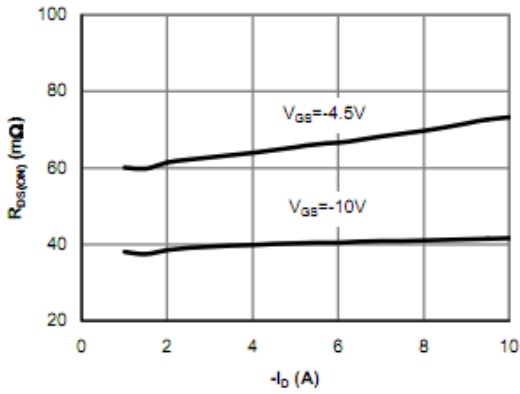

Figure 3: On-Resistance vs. Drain Current and Gate Voltage

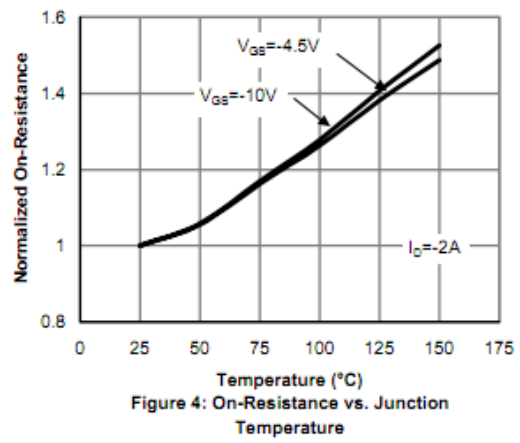

Figure 4: On-Resistance vs. Junction Temperature

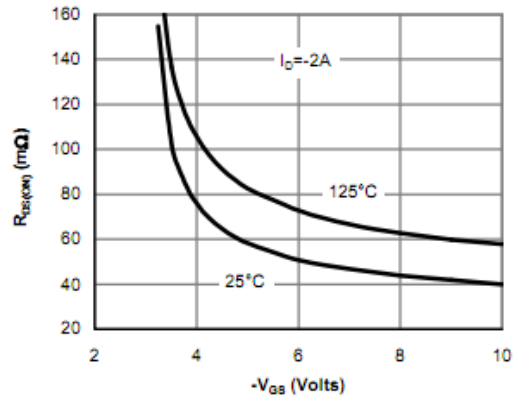

Figure 5: On-Resistance vs. Gate-Source Voltage

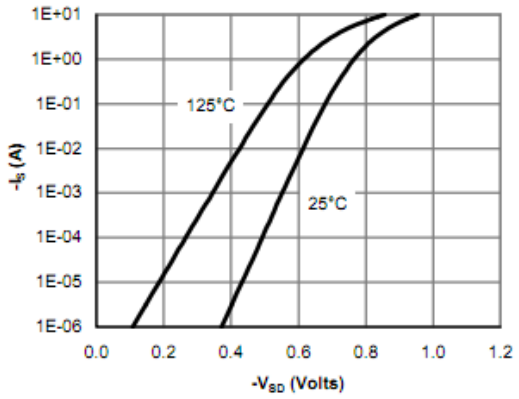

Figure 6: Body-Diode Characteristics

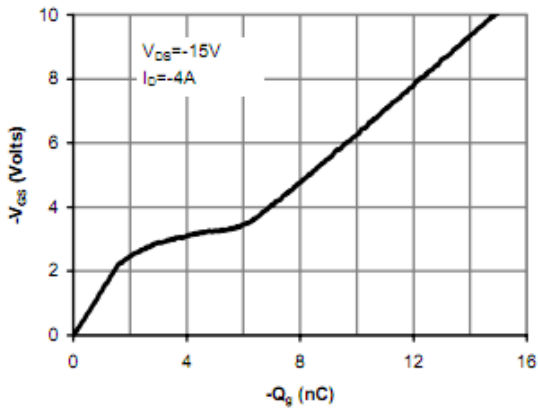

Figure 7: Gate-Charge Characteristics

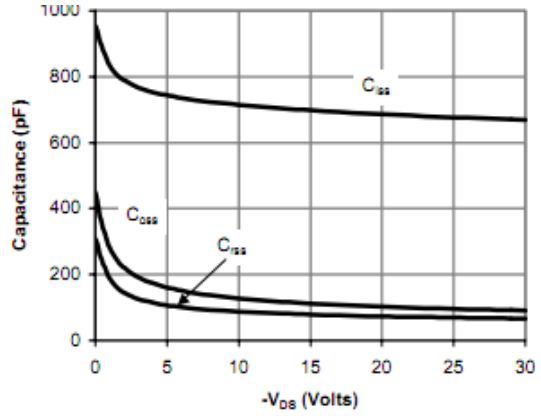

Figure 8: Capacitance Characteristics

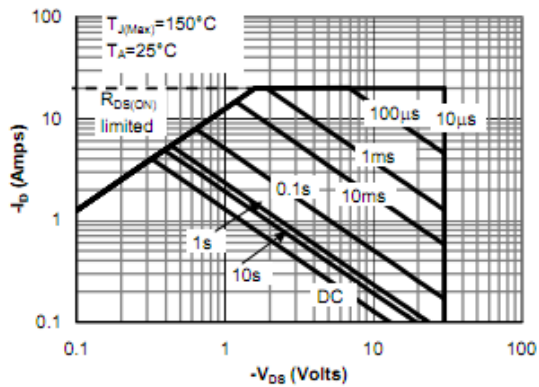

Figure 9: Maximum Forward Biased Safe Operating Area (Note E)

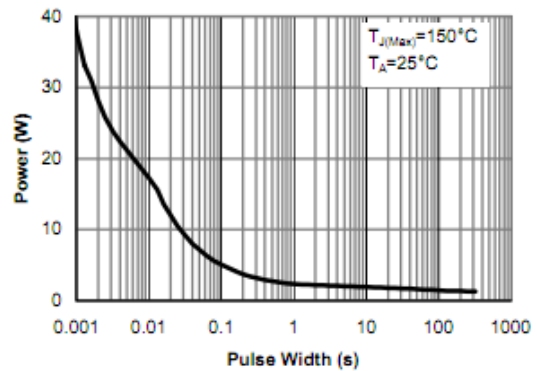

Figure 10: Single Pulse Power Rating Junction-to-Ambient (Note E)

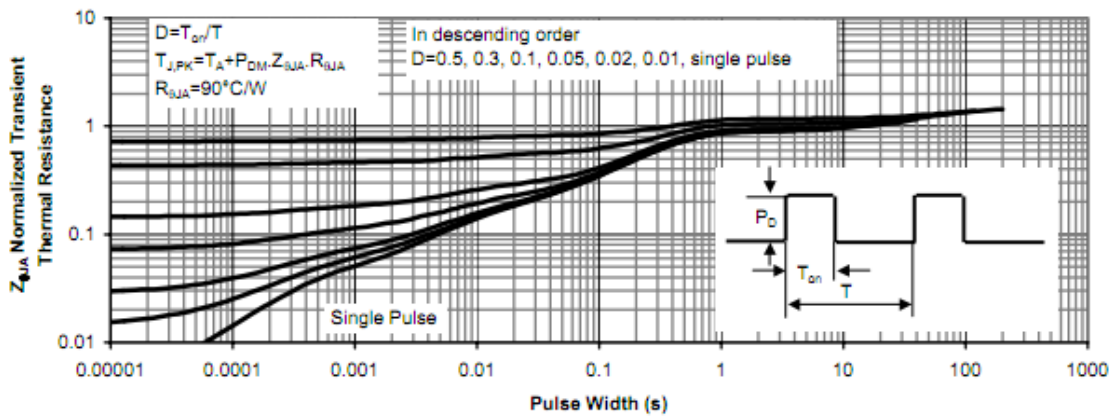

Figure 11: Normalized Maximum Transient Thermal Impedance

## X-ON Electronics

Largest Supplier of Electrical and Electronic Components

*Click to view similar products for [MOSFET](#) category:*

*Click to view products by [ALJ](#) manufacturer:*

Other Similar products are found below :

[IRFD120](#) [IRFY240C](#) [JANTX2N5237](#) [2SK2267\(Q\)](#) [BUK455-60A/B](#) [MIC4420CM-TR](#) [VN1206L](#) [NDP4060](#) [SI4482DY](#)  
[IPS70R2K0CEAKMA1](#) [SQD23N06-31L-GE3](#) [TK16J60W,S1VQ\(O](#) [2SK2614\(TE16L1,Q\)](#) [DMN1017UCP3-7](#) [EFC2J004NUZTDG](#)  
[DMN1053UCP4-7](#) [SQJ469EP-T1-GE3](#) [NTE2384](#) [DMC2700UDMQ-7](#) [DMN2080UCB4-7](#) [DMN61D9UWQ-13](#) [US6M2GTR](#)  
[DMN31D5UDJ-7](#) [DMP22D4UFO-7B](#) [DMN1006UCA6-7](#) [DMN16M9UCA6-7](#) [STF5N65M6](#) [IRF40H233XTMA1](#) [STU5N65M6](#)  
[DMN6022SSD-13](#) [DMN13M9UCA6-7](#) [DMTH10H4M6SPS-13](#) [DMN2990UFB-7B](#) [IPB80P04P405ATMA2](#) [2N7002W-G](#) [MCAC30N06Y-](#)  
[TP](#) [MCQ7328-TP](#) [NTMC083NP10M5L](#) [NVMFS2D3P04M8LT1G](#) [BXP7N65D](#) [BXP4N65F](#) [AOL1454G](#) [WMJ80N60C4](#) [BXP2N20L](#)  
[BXP2N65D](#) [BXT1150N10J](#) [BXT1700P06M](#) [TSM60NB380CP](#) [ROG](#) [RQ7L055BGTCR](#) [DMNH15H110SK3-13](#)