



SOT-23 Plastic-Encapsulate Transistors

BC848A NPN Transistors

Features

- Ideally suited for automatic insertion
- For switching and AF amplifier applications

Marking

- BC848A: 1J
- BC848B: 1K
- BC848C: 1L

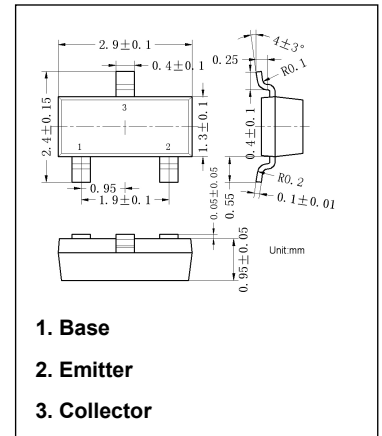

Maximum Ratings ($T_a=25^\circ\text{C}$ unless otherwise noted)

Symbol	Parameter	Value	Unit
V_{CB0}	Collector Base Voltage	30	V
V_{CE0}	Collector Emitter Voltage	30	V
V_{EB0}	Emitter Base Voltage	6	V
I_c	Collector Current	0.1	A
P_c	Collector Power Dissipation	200	mW
$R_{\theta JA}$	Thermal Resistance from Junction to Ambient	625	$^\circ\text{C}/\text{W}$
T_j	Junction Temperature	150	$^\circ\text{C}$
T_{stg}	Storage Temperature	- 55 to +150	$^\circ\text{C}$

Electrical Characteristics ($T_a=25^\circ\text{C}$ unless otherwise specified)

Symbol	Parameter	Test Conditions	Min	Typ	Max	Unit
$V_{(BR)CBO}$	Collector-base breakdown voltage	$I_c=10\mu\text{A}, I_E=0$	30			V
$V_{(BR)CEO}$	Collector-emitter breakdown voltage	$I_c=10\text{mA}, I_B=0$	30			V
$V_{(BR)EBO}$	Emitter-base breakdown voltage	$I_E=10\mu\text{A}, I_c=0$	6			V
I_{CBO}	Collector cut-off current	$V_{CB}=30\text{V}, I_E=0$			100	nA
I_{CEO}	Collector cut-off current	$V_{CE}=30\text{V}, I_B=0$			100	nA
I_{EBO}	Emitter cut-off current	$V_{EB}=5\text{V}, I_c=0$			100	nA
h_{FE}	DC current gain	BC848A	110		220	
		BC848B				
		BC848C				
		$V_{CE} = 5\text{V}, I_c = 2\text{mA}$	110			
$V_{CE(sat)}$	Collector-emitter saturation voltage	$I_c = 100\text{mA}, I_B = 5\text{mA}$			0.5	V
$V_{BE(sat)}$	Base-emitter saturation voltage	$I_c = 100\text{mA}, I_B = 5\text{mA}$			1.1	V
f_T	Transition frequency	$V_{CE}=5\text{V}, I_c=10\text{mA}, f=100\text{MHz}$	100			MHz
C_{ob}	Collector output capacitance	$V_{CB} = 10\text{V}, f = 1\text{MHz}$			4.5	pF

Typical Characteristics

Static Characteristic

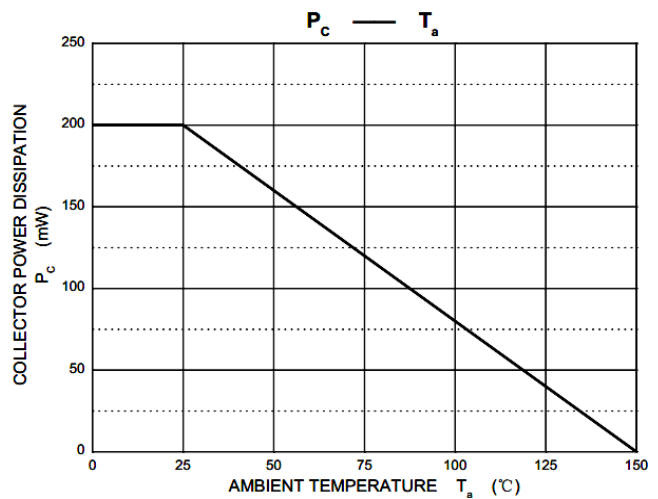
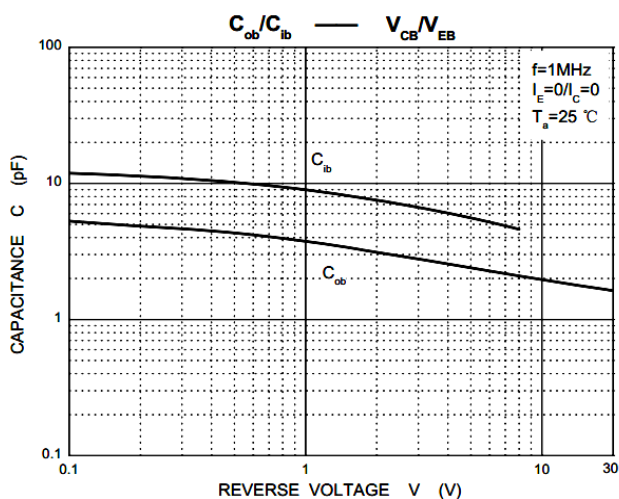
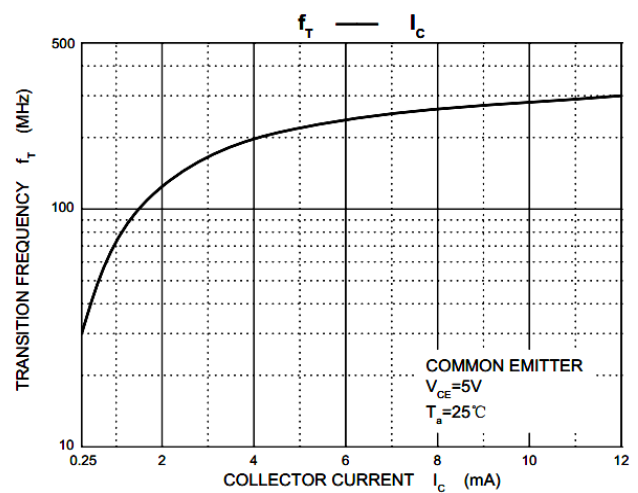
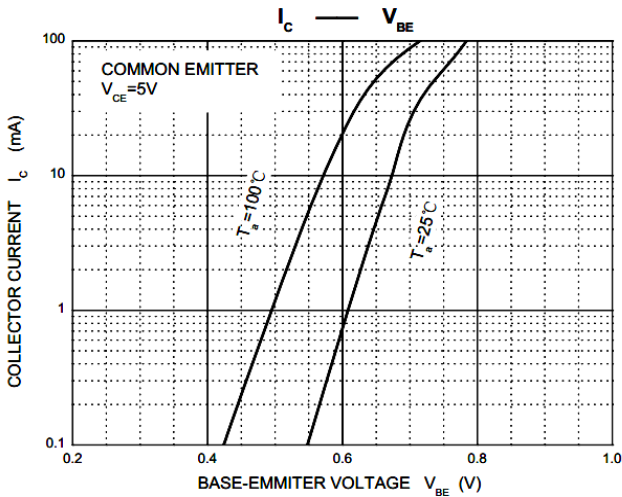
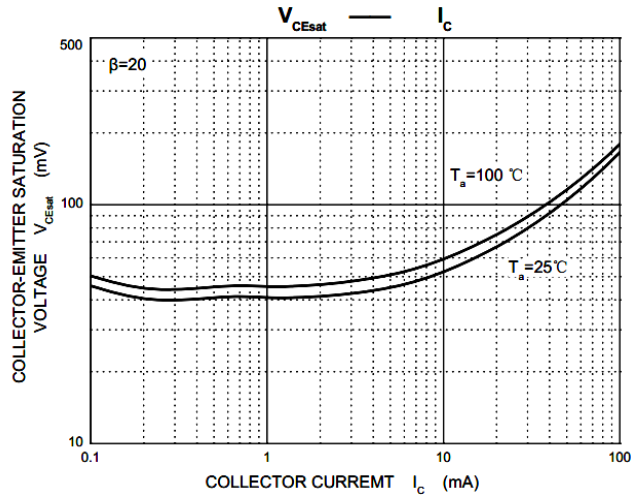
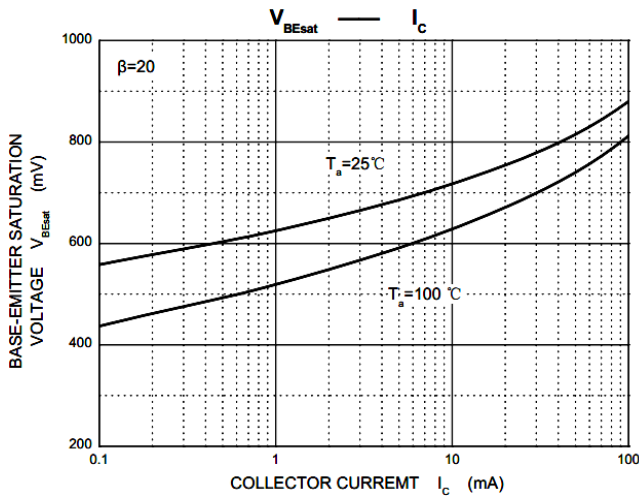
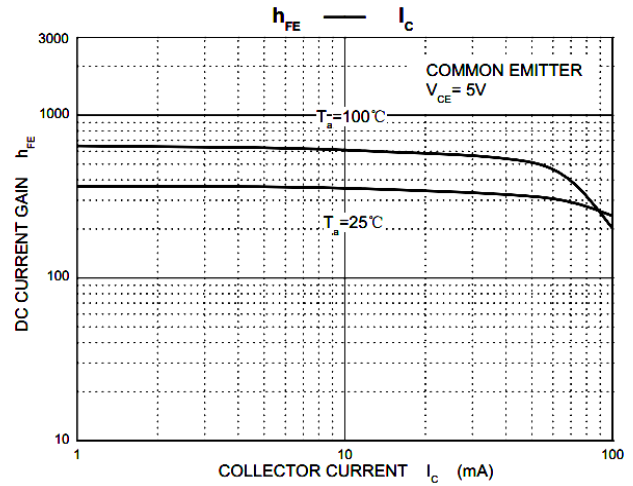
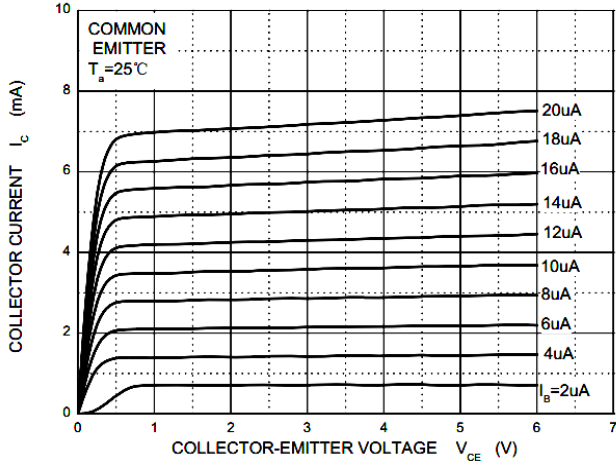

X-ON Electronics

Largest Supplier of Electrical and Electronic Components

Click to view similar products for [Bipolar Transistors - BJT category](#):

Click to view products by [ALJ manufacturer](#):

Other Similar products are found below :

[BC559C](#) [MCH4017-TL-H](#) [MMBT-2369-TR](#) [BC546/116](#) [NJVMJD148T4G](#) [NTE16](#) [NTE195A](#) [IMX9T110](#) [2N4401-A](#) [2N6728](#) [2SA1419T-TD-H](#) [2SB1204S-TL-E](#) [2SC5488A-TL-H](#) [FMC5AT148](#) [2N2369ADCSM](#) [2N2907A](#) [2N3904-NS](#) [2N5769](#) [2SC4618TLN](#) [CPH6501-TL-E](#) [BC856BW-13-F](#) [US6T6TR](#) [BAX18/A52R](#) [BC556/112](#) [IMZ2AT108](#) [MMST8098T146](#) [MCH6102-TL-E](#) [BC846B-13-F](#) [2N3879](#) [30A02MH-TL-E](#) [NTE13](#) [NTE282](#) [NTE323](#) [NTE350](#) [NTE81](#) [JANTX2N2920L](#) [JANSR2N2907AUB](#) [CMLT3946EG TR](#) [SNSS40600CF8T1G](#) [CMLT3906EG TR](#) [GRP-DATA-JANS2N2907AUB](#) [GRP-DATA-JANS2N2222AUA](#) [MMDT3946FL3-7](#) [2N4240](#) [JANS2N3019](#) [MSB30KH-13](#) [2N2221AUB](#) [2SD1815T-TL-E](#) [2N6678](#) [2N2907Ae4](#)