



## SOT-23 Plastic-Encapsulate Transistors

### BC857B PNP Transistors

#### Features

- Ideally suited for automatic insertion
- For switching and AF amplifier applications

#### Marking

- BC857A: 3E
- BC857B: 3F
- BC857C: 3G

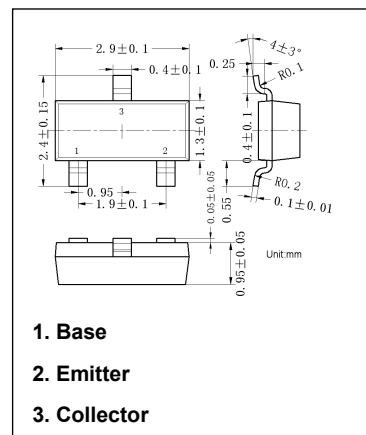

#### Maximum Ratings ( $T_a=25^\circ\text{C}$ unless otherwise noted)

Symbol	Parameter	Value	Unit
$V_{CB0}$	Collector Base Voltage	-50	V
$V_{CEO}$	Collector Emitter Voltage	-45	V
$V_{EBO}$	Emitter Base Voltage	-5	V
$I_c$	Collector Current	-0.1	A
$P_c$	Collector Power Dissipation	200	mW
$R_{\theta JA}$	Thermal Resistance from Junction to Ambient	625	$^\circ\text{C/W}$
$T_j$	Junction Temperature	150	$^\circ\text{C}$
$T_{stg}$	Storage Temperature	- 55 to +150	$^\circ\text{C}$

#### Electrical Characteristics ( $T_a=25^\circ\text{C}$ unless otherwise specified)

Symbol	Parameter	Test Conditions	Min	Typ	Max	Unit
$V_{(BR)CBO}$	Collector-base breakdown voltage	$I_c = -10\mu\text{A}, I_E = 0$	-50			V
$V_{(BR)CEO}$	Collector-emitter breakdown voltage	$I_c = -10\text{mA}, I_B = 0$	-45			V
$V_{(BR)EBO}$	Emitter-base breakdown voltage	$I_E = -1\mu\text{A}, I_C = 0$	-5			V
$I_{CBO}$	Collector cut-off current	$V_{CB} = -45\text{V}, I_E = 0$			-100	nA
$I_{CEO}$	Collector cut-off current	$V_{CE} = -40\text{V}, I_B = 0$			-100	nA
$I_{EBO}$	Emitter cut-off current	$V_{EB} = -5\text{V}, I_C = 0$			-100	nA
$h_{FE}$	DC current gain	BC857A	125	210	250	
		BC857B				
		BC857C				
		$V_{CE} = -5\text{V}, I_C = -2\text{mA}$		125		
$V_{CE(sat)}$	Collector-emitter saturation voltage	$I_c = -100\text{mA}, I_B = -5\text{mA}$			-0.5	V
$V_{BE(sat)}$	Base-emitter saturation voltage	$I_c = -100\text{mA}, I_B = -5\text{mA}$			-1.1	V
$f_r$	Transition frequency	$V_{CE} = -5\text{V}, I_c = -10\text{mA}, f = 100\text{MHz}$	100			MHz
$C_{ob}$	Collector output capacitance	$V_{CB} = -10\text{V}, f = 1\text{MHz}$			4.5	pF

# Typical Characteristics

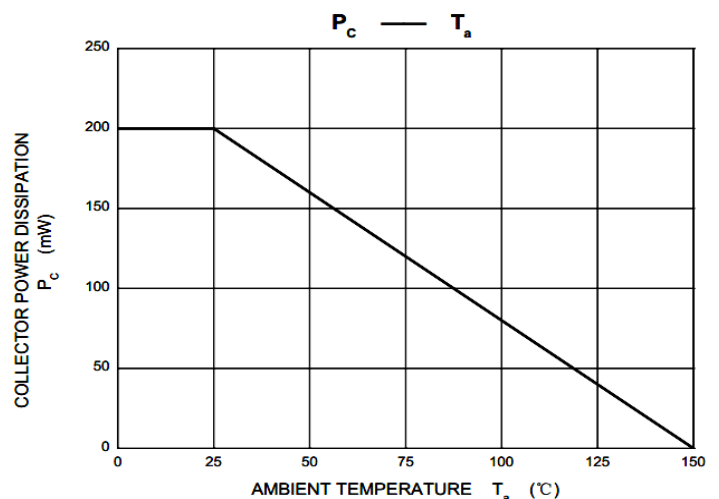
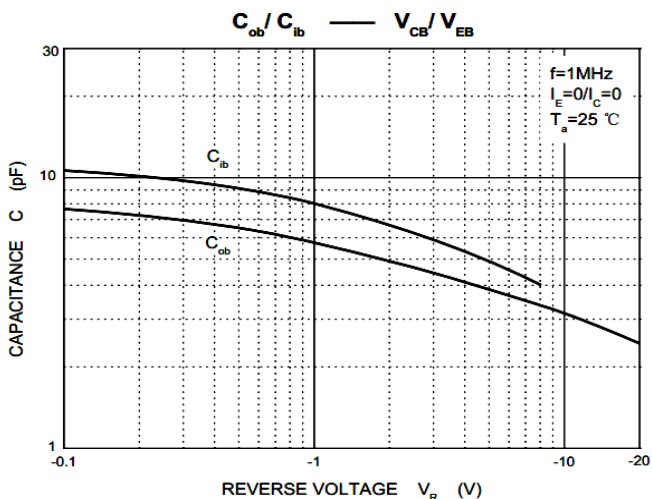
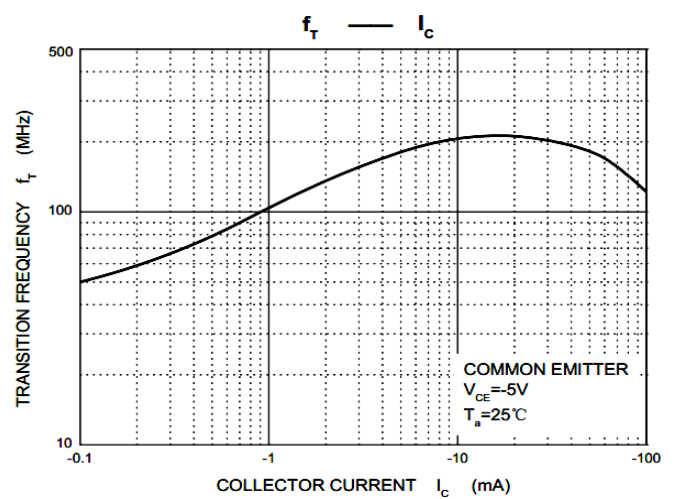
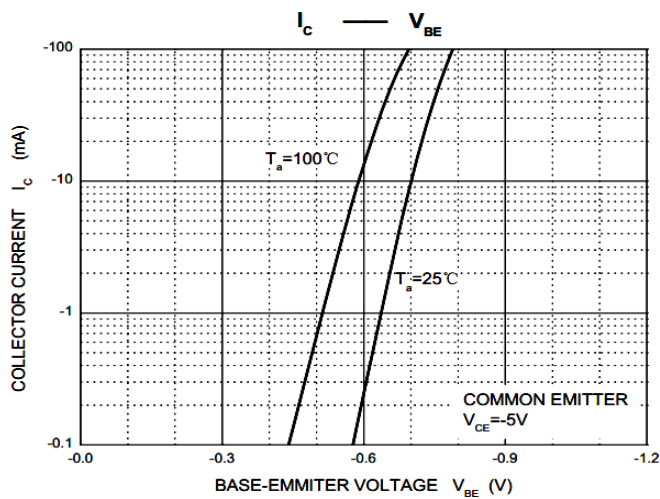
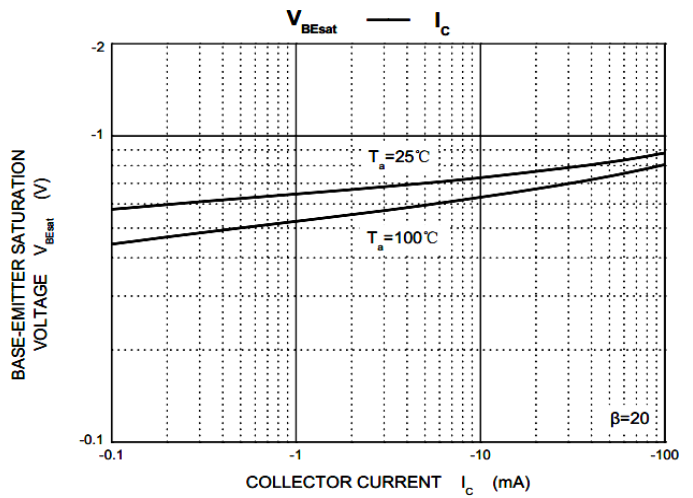
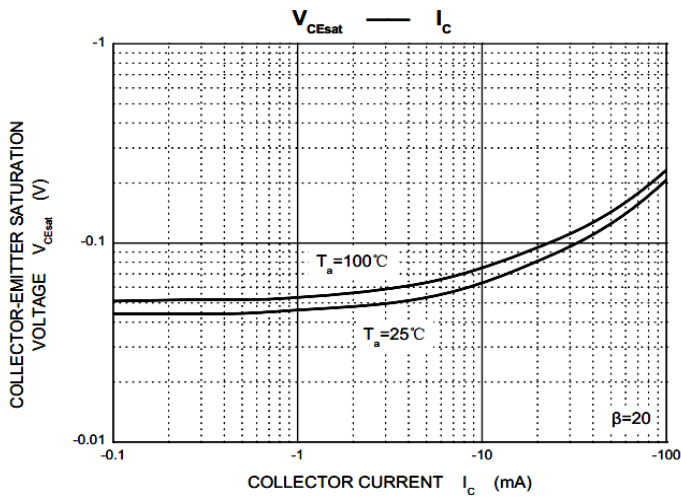
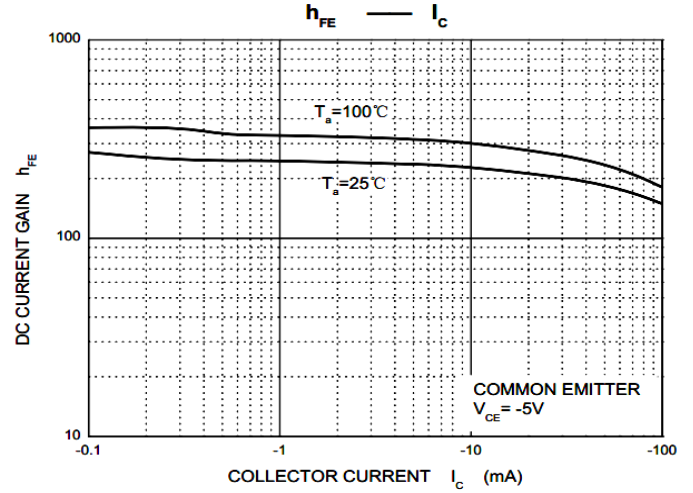
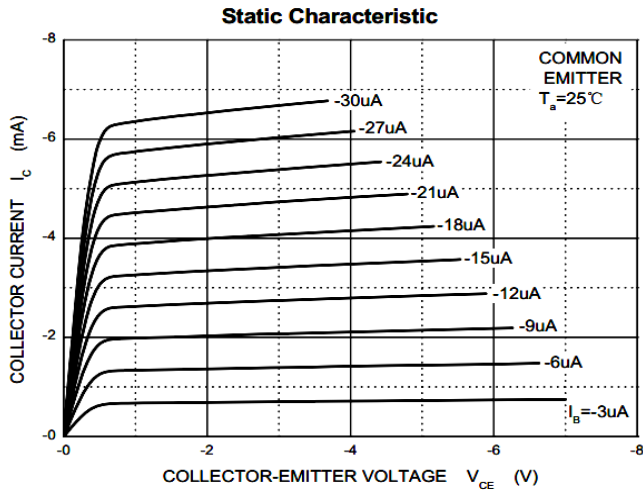

## X-ON Electronics

Largest Supplier of Electrical and Electronic Components

*Click to view similar products for [Bipolar Transistors - BJT category](#):*

*Click to view products by [ALJ manufacturer](#):*

Other Similar products are found below :

[BC559C](#) [MCH4017-TL-H](#) [MMBT-2369-TR](#) [BC546/116](#) [NJVMJD148T4G](#) [NTE16](#) [NTE195A](#) [IMX9T110](#) [2N4401-A](#) [2N6728](#) [2SA1419T-TD-H](#) [2SB1204S-TL-E](#) [2SC5488A-TL-H](#) [FMC5AT148](#) [2N2369ADCSM](#) [2N2907A](#) [2N3904-NS](#) [2N5769](#) [2SC4618TLN](#) [CPH6501-TL-E](#) [BC856BW-13-F](#) [US6T6TR](#) [BAX18/A52R](#) [BC556/112](#) [IMZ2AT108](#) [MMST8098T146](#) [MCH6102-TL-E](#) [2N3879](#) [30A02MH-TL-E](#) [NTE13](#) [NTE282](#) [NTE323](#) [NTE350](#) [NTE81](#) [JANTX2N2920L](#) [JANSR2N2907AUB](#) [CMLT3946EG TR](#) [SNSS40600CF8T1G](#) [CMLT3906EG TR](#) [GRP-DATA-JANS2N2907AUB](#) [GRP-DATA-JANS2N2222AUA](#) [MMDT3946FL3-7](#) [2N4240](#) [JANS2N3019](#) [MSB30KH-13](#) [2N2221AUB](#) [2SD1815T-TL-E](#) [2N6678](#) [2N2907Ae4](#) [JAN2N3507](#)