

## Chopper-Stabilized Precision Hall-Effect Switches

### FEATURES AND BENEFITS

- AEC-Q100 automotive qualified
- Unipolar switch points
- Resistant to physical stress
- Superior temperature stability
- Output short-circuit protection
- Operation from unregulated supply
- Reverse-battery protection
- Solid-state reliability
- Small package sizes

### PACKAGES:

Not to scale

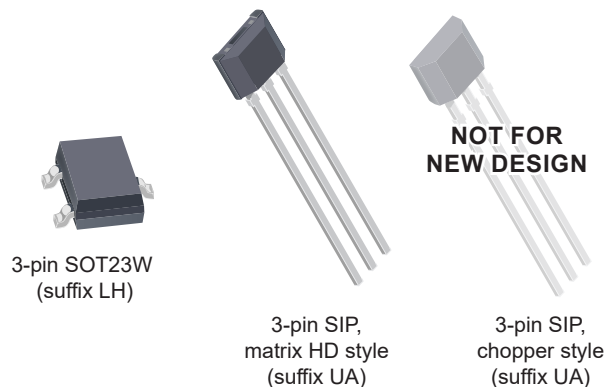

### DESCRIPTION

The A1120, A1121, A1122, A1123, and A1125 Hall-effect unipolar switches are extremely temperature-stable and stress-resistant sensor ICs, especially suited for operation over extended temperature ranges to 150°C. Superior high-temperature performance is made possible through dynamic offset cancellation, which reduces the residual offset voltage normally caused by device overmolding, temperature dependencies, and thermal stress.

Each device includes on a single silicon chip a voltage regulator, Hall-voltage generator, small-signal amplifier, chopper stabilization, Schmitt trigger, and a short-circuit protected open-drain output to sink up to 25 mA.

An on-board regulator permits operation with supply voltages of 3 to 24 V. The advantage of operating down to 3 V is that the device can be used in 3 V applications or with additional external resistance in series with the supply pin for greater protection against high-voltage transient events.

For the A1120, A1121, A1122, and A1123, a south pole of sufficient strength turns the output on. Removal of the magnetic field turns the output off. The A1125 is complementary, in that for these devices, a south pole turns the A1125 output off, and removal of the magnetic field turns the output on.

Two package styles provide a magnetically optimized package for most applications. Package type LH is a modified SOT23W, surface-mount package, while UA is a three-lead ultra-mini SIP for through-hole mounting. Each package type is lead (Pb) free (suffix, -T), with a 100% matte-tin-plated leadframe.

### Functional Block Diagram

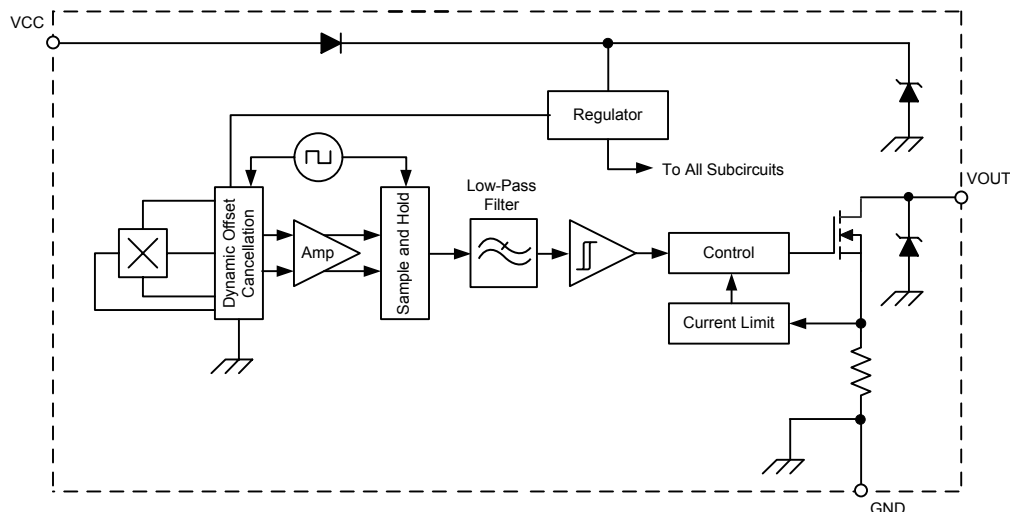

## SELECTION GUIDE

Part Number	Packing [1]	Mounting	Ambient, T <sub>A</sub> (°C)	Switchpoints (Typ.) (G)		Output In South (Positive) Magnetic Field
				B <sub>OP</sub>	B <sub>RP</sub>	
A1120ELHLX-T	13-in. reel, 10000 pieces/reel	3-pin SOT23W surface mount	-40 to 85	35	25	On (logic low)
A1120ELHLT-T <sup>[2]</sup>	7-in. reel, 3000 pieces/reel	3-pin SOT23W surface mount				
A1120EUA-T <sup>[3]</sup>	Bulk, 500 pieces/bag	3-pin SIP through hole				
A1120LLHLX-T	13-in. reel, 10000 pieces/reel	3-pin SOT23W surface mount	-40 to 150			
A1120LLHLT-T <sup>[2]</sup>	7-in. reel, 3000 pieces/reel	3-pin SOT23W surface mount				
A1120LUA-T <sup>[3]</sup>	Bulk, 500 pieces/bag	3-pin SIP through hole				
A1121ELHLX-T	13-in. reel, 10000 pieces/reel	3-pin SOT23W surface mount	-40 to 85	95	70	
A1121ELHLT-T <sup>[2]</sup>	7-in. reel, 3000 pieces/reel	3-pin SOT23W surface mount				
A1121EUA-T <sup>[3]</sup>	Bulk, 500 pieces/bag	3-pin SIP through hole				
A1121LLHLX-T	13-in. reel, 10000 pieces/reel	3-pin SOT23W surface mount	-40 to 150			
A1121LLHLT-T <sup>[2]</sup>	7-in. reel, 3000 pieces/reel	3-pin SOT23W surface mount				
A1121LUA-T <sup>[3]</sup>	Bulk, 500 pieces/bag	3-pin SIP through hole				
A1122ELHLX-T	13-in. reel, 10000 pieces/reel	3-pin SOT23W surface mount	-40 to 85	150	125	
A1122ELHLT-T <sup>[2]</sup>	7-in. reel, 3000 pieces/reel	3-pin SOT23W surface mount				
A1122EUA-T <sup>[3]</sup>	Bulk, 500 pieces/bag	3-pin SIP through hole				
A1122LLHLX-T	13-in. reel, 10000 pieces/reel	3-pin SOT23W surface mount	-40 to 150			
A1122LLHLT-T <sup>[2]</sup>	7-in. reel, 3000 pieces/reel	3-pin SOT23W surface mount				
A1122LUA-T <sup>[3]</sup>	Bulk, 500 pieces/bag	3-pin SIP through hole				
A1123LLHLX-T	13-in. reel, 10000 pieces/reel	3-pin SOT23W surface mount	-40 to 150	280	225	
A1123LLHLT-T <sup>[2]</sup>	7-in. reel, 3000 pieces/reel	3-pin SOT23W surface mount				
A1123LUA-T <sup>[3]</sup>	Bulk, 500 pieces/bag	3-pin SIP through hole				
A1125ELHLX-T	13-in. reel, 10000 pieces/reel	3-pin SOT23W surface mount	-40 to 85	35	25	Off (logic high)
A1125ELHLT-T <sup>[2]</sup>	7-in. reel, 3000 pieces/reel	3-pin SOT23W surface mount				
A1125EUA-T <sup>[3]</sup>	Bulk, 500 pieces/bag	3-pin SIP through hole				
A1125LLHLX-T	13-in. reel, 10000 pieces/reel	3-pin SOT23W surface mount	-40 to 150			
A1125LLHLT-T <sup>[2]</sup>	7-in. reel, 3000 pieces/reel	3-pin SOT23W surface mount				
A1125LUA-T <sup>[3]</sup>	Bulk, 500 pieces/bag	3-pin SIP through hole				

[1] Contact Allegro for additional packing options.

[2] Available through authorized Allegro distributors only.

[3] The chopper-style UA package is not for new design; the matrix HD style UA package is recommended for new designs.



## ABSOLUTE MAXIMUM RATINGS

Characteristic	Symbol	Notes	Rating	Units
Forward Supply Voltage	$V_{CC}$		26.5	V
Reverse Supply Voltage	$V_{RCC}$		-30	V
Output Off Voltage	$V_{OUT}$		26	V
Continuous Output Current	$I_{OUT}$		25	mA
Reverse Output Current	$I_{ROUT}$		-50	mA
Operating Ambient Temperature	$T_A$	Range E	-40 to 85	°C
		Range L	-40 to 150	°C
Maximum Junction Temperature	$T_J(max)$		165	°C
Storage Temperature	$T_{stg}$		-65 to 170	°C

## PINOUT DIAGRAMS AND TERMINAL LIST TABLE

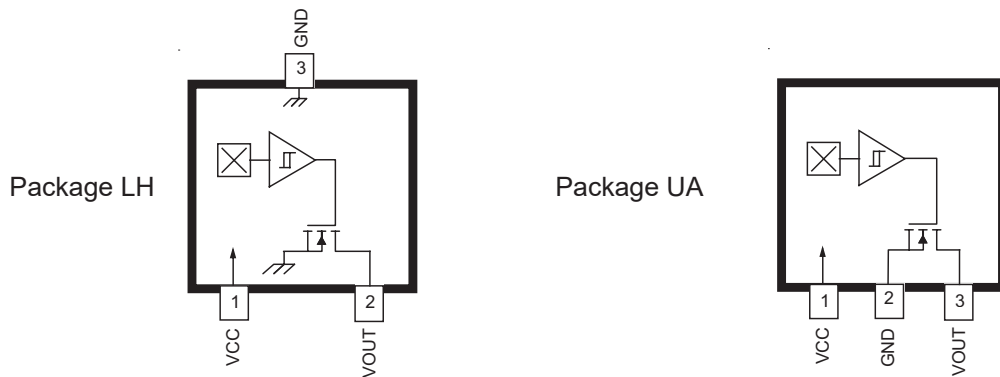

### Terminal List

Name	Description	Number	
		Package LH	Package UA
VCC	Connects power supply to chip	1	1
VOUT	Output from circuit	2	3
GND	Ground	3	2

**ELECTRICAL CHARACTERISTICS: Valid over full operating voltage and ambient temperature ranges, unless otherwise noted**

Characteristics	Symbol	Test Conditions		Min.	Typ. [1]	Max.	Unit [2]
<b>ELECTRICAL CHARACTERISTICS</b>							
Forward Supply Voltage	$V_{CC}$	Operating, $T_J < 165^\circ\text{C}$		3	–	24	V
Output Leakage Current	$I_{OUTOFF}$	A1120 A1121 A1122 A1123	$V_{OUT} = 24\text{ V}, B < B_{RP}$	–	–	10	$\mu\text{A}$
		A1125	$V_{OUT} = 24\text{ V}, B > B_{OP}$	–	–	10	$\mu\text{A}$
Output Saturation Voltage	$V_{OUT(SAT)}$	A1120 A1121 A1122 A1123	$I_{OUT} = 20\text{ mA}, B > B_{OP}$	–	185	500	mV
		A1125	$I_{OUT} = 20\text{ mA}, B < B_{RP}$	–	185	500	mV
Output Current Limit	$I_{OM}$	A1120 A1121 A1122 A1123	$B > B_{OP}$	30	–	60	mA
		A1125	$B < B_{RP}$	30	–	60	mA
Power-On Time [3]	$t_{PO}$	$V_{CC} > 3.0\text{ V}, B < B_{RP}(\text{min}) - 10\text{ G},$ $B > B_{OP}(\text{max}) + 10\text{ G}$		–	–	25	$\mu\text{s}$
Chopping Frequency	$f_C$			–	800	–	kHz
Output Rise Time [3][4]	$t_r$	$R_L = 820\ \Omega, C_S = 20\ \text{pF}$		–	0.2	2	$\mu\text{s}$
Output Fall Time [3][4]	$t_f$	$R_L = 820\ \Omega, C_S = 20\ \text{pF}$		–	0.1	2	$\mu\text{s}$
Supply Current	$I_{CC(ON)}$	A1120 A1121 A1122 A1123	$V_{CC} = 12\text{ V}, B > B_{OP}$	–	–	4	mA
		A1125	$V_{CC} = 12\text{ V}, B < B_{RP}$	–	–	4	mA
	$I_{CC(OFF)}$	A1120 A1121 A1122 A1123	$V_{CC} = 12\text{ V}, B < B_{RP}$	–	–	4	mA
		A1125	$V_{CC} = 12\text{ V}, B > B_{OP}$	–	–	4	mA
Reverse Supply Current	$I_{RCC}$	$V_{RCC} = -30\text{ V}$		–	–	-5	mA
Supply Zener Clamp Voltage	$V_Z$	$I_{CC} = 5\text{ mA}; T_A = 25^\circ\text{C}$		28	–	–	V
Zener Impedance	$I_Z$	$I_{CC} = 5\text{ mA}; T_A = 25^\circ\text{C}$		–	50	–	$\Omega$

Continued on the next page...

**ELECTRICAL CHARACTERISTICS (continued):** Valid over full operating voltage and ambient temperature ranges, unless otherwise noted

Characteristics	Symbol	Test Conditions	Min.	Typ. [1]	Max.	Unit [2]	
<b>MAGNETIC CHARACTERISTICS</b>							
Operate Point	B <sub>OP</sub>	A1120	–	35	50	G	
		A1121	50	95	135	G	
		A1122	120	150	200	G	
		A1123	205	280	355	G	
		A1125	–	35	50	G	
Release Point	B <sub>RP</sub>	A1120	5	25	–	G	
		A1121	40	70	110	G	
		A1122	110	125	190	G	
		A1123	150	225	300	G	
		A1125	5	25	–	G	
Hysteresis	B <sub>HYS</sub>	(B <sub>OP</sub> – B <sub>RP</sub> )	A1120	–	10	–	G
			A1121	10	25	42	G
			A1122	10	25	42	G
			A1123	30	55	80	G
			A1125	–	10	–	G

[1] Typical data are at T<sub>A</sub> = 25°C and V<sub>CC</sub> = 12 V, and are for initial design estimations only.

[2] 1 G (gauss) = 0.1 mT (millitesla).

[3] Guaranteed by device design and characterization.

[4] C<sub>S</sub> = oscilloscope probe capacitance.

**THERMAL CHARACTERISTICS: May require derating at maximum conditions; see application information**

Characteristic	Symbol	Test Conditions	Value	Units
Package Thermal Resistance	$R_{\theta JA}$	Package LH, 1-layer PCB with copper limited to solder pads	228	°C/W
		Package LH, 2-layer PCB with 0.463 in <sup>2</sup> of copper area each side connected by thermal vias	110	°C/W
		Package UA, 1-layer PCB with copper limited to solder pads	165	°C/W

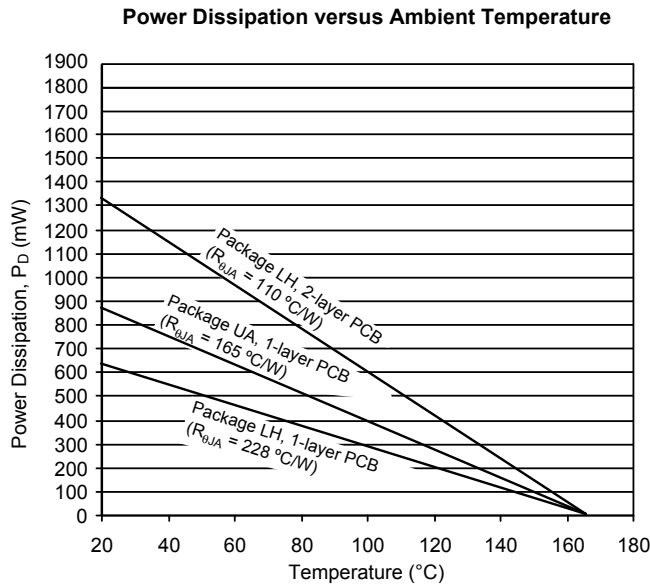
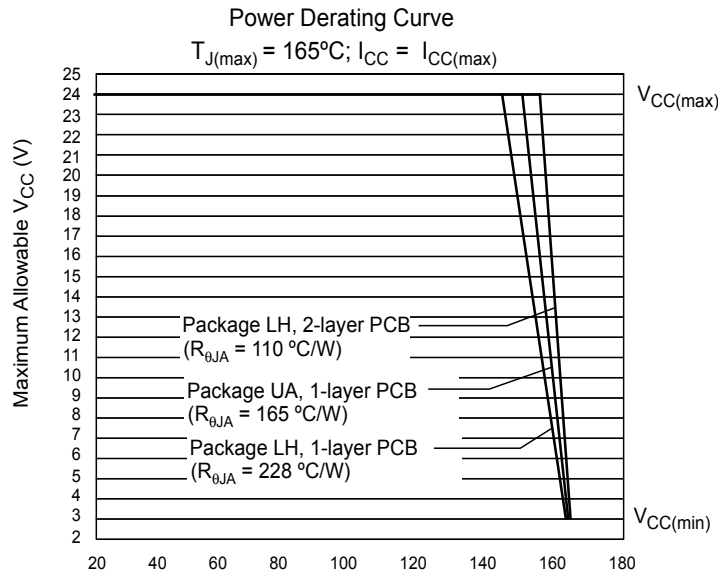

## CHARACTERISTIC PERFORMANCE A1120, A1121, A1122, A1123, and A1125 Electrical Characteristics

Average Supply Current (On) versus Ambient Temperature

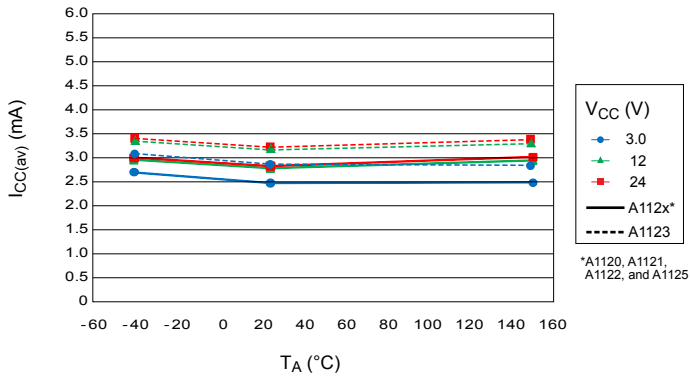

Average Supply Current (On) versus Average Supply Voltage

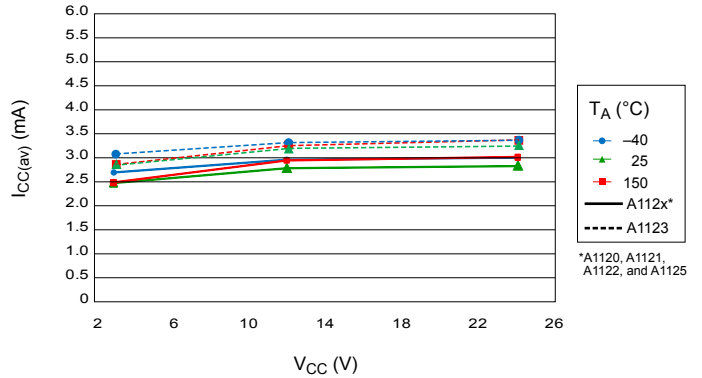

Average Supply Current (Off) versus Ambient Temperature

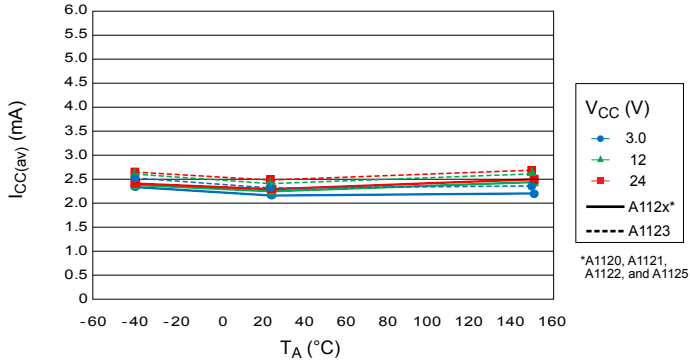

Average Supply Current (Off) versus Average Supply Voltage

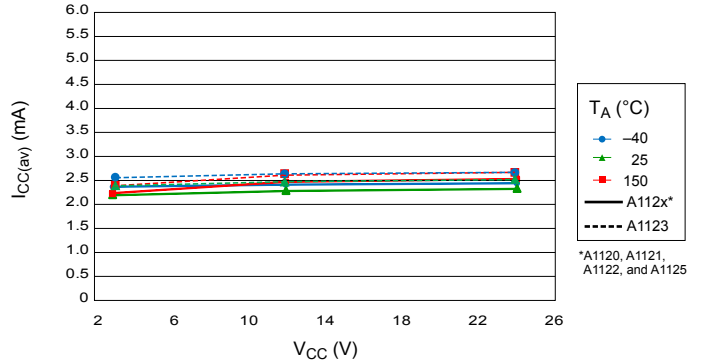

Average Output Saturation Voltage versus Ambient Temperature

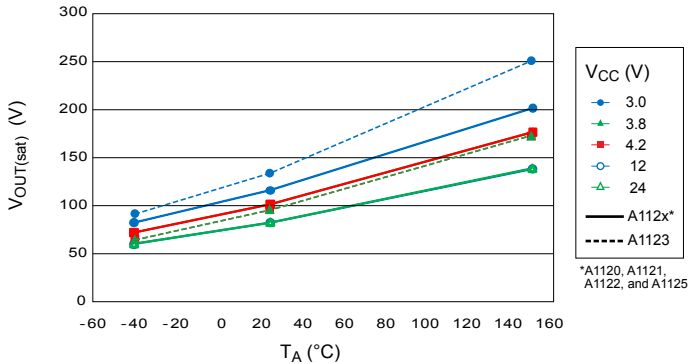

Average Output Saturation Voltage versus Supply Voltage

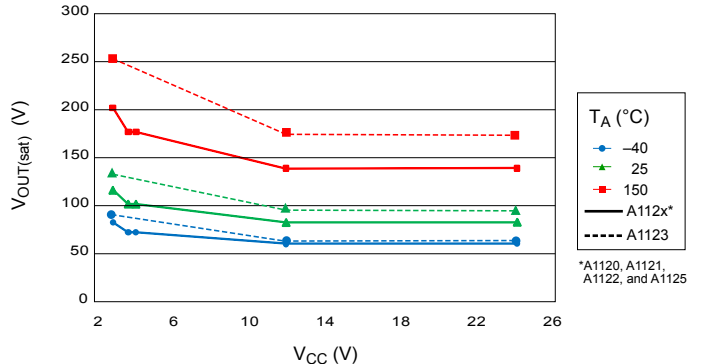

## A1120 and A1125 Magnetic Characteristics

Average Operate Point versus Ambient Temperature

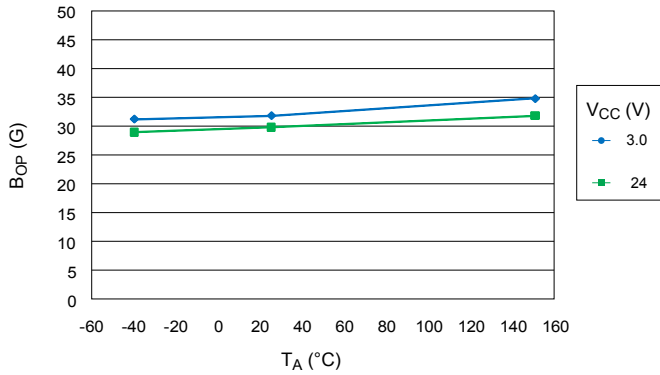

Average Operate Point versus Average Supply Voltage

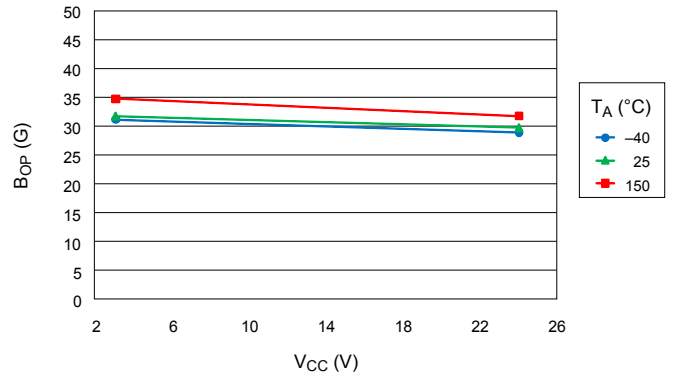

Average Release Point versus Ambient Temperature

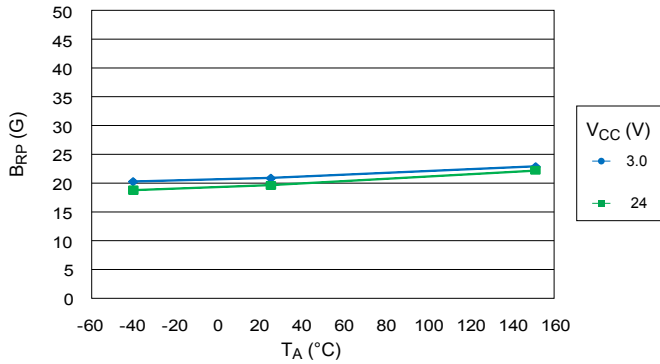

Average Release Point versus Average Supply Voltage

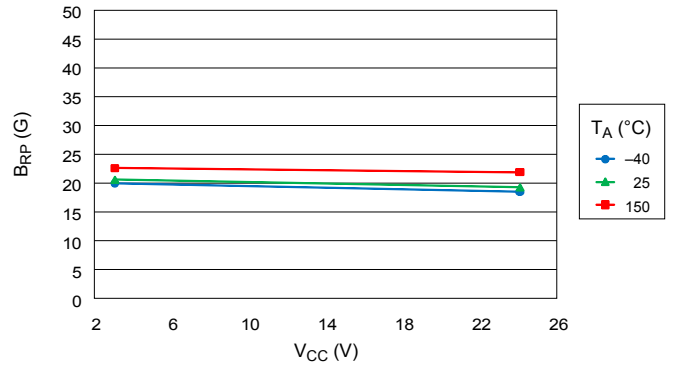

Average Switchpoint Hysteresis versus Ambient Temperature

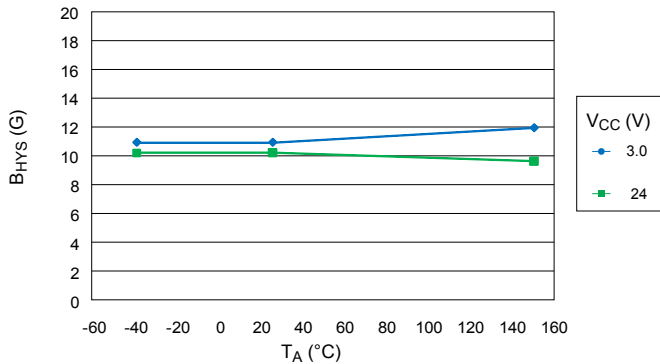

Average Switchpoint Hysteresis versus Supply Voltage

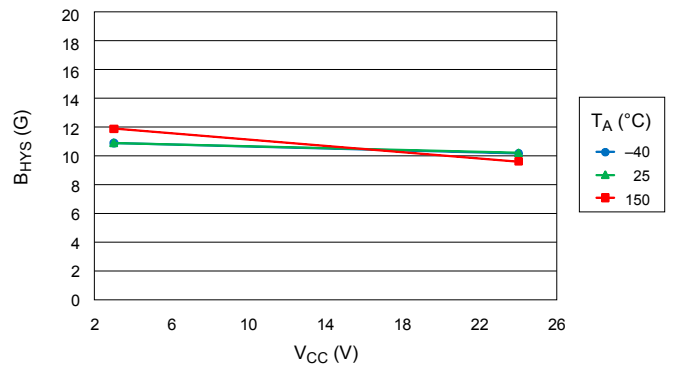



## A1121 Magnetic Characteristics

Average Operate Point versus Ambient Temperature

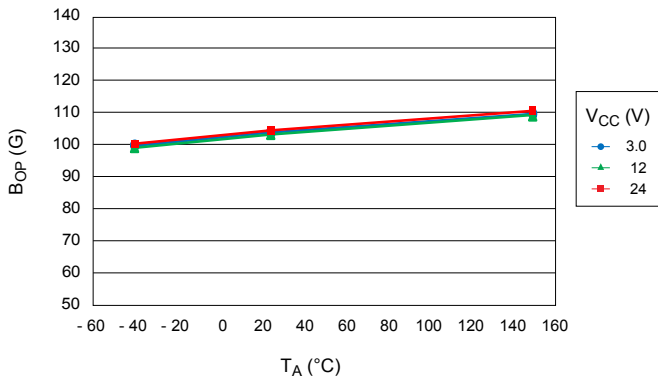

Average Operate Point versus Average Supply Voltage

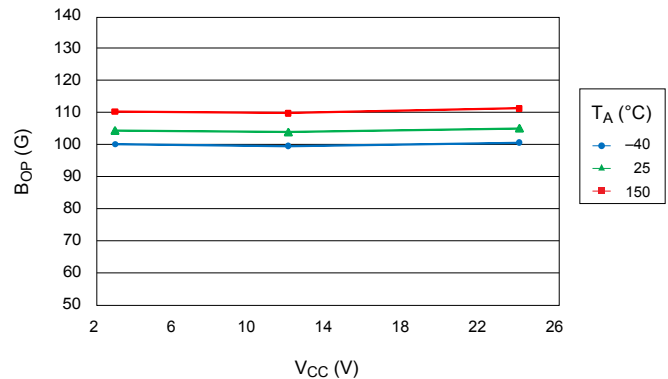

Average Release Point versus Ambient Temperature

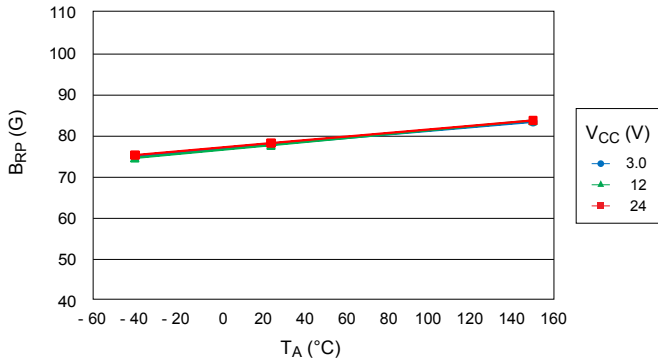

Average Release Point versus Average Supply Voltage

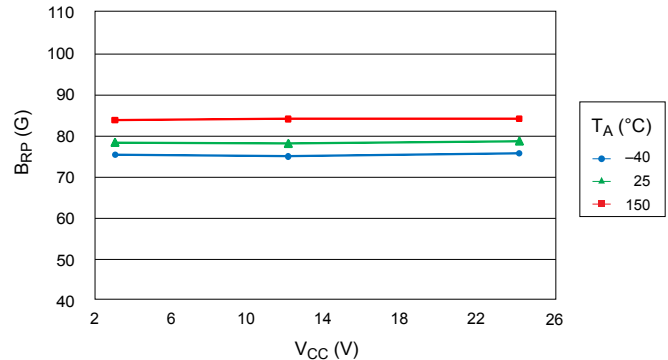

Average Switchpoint Hysteresis versus Ambient Temperature

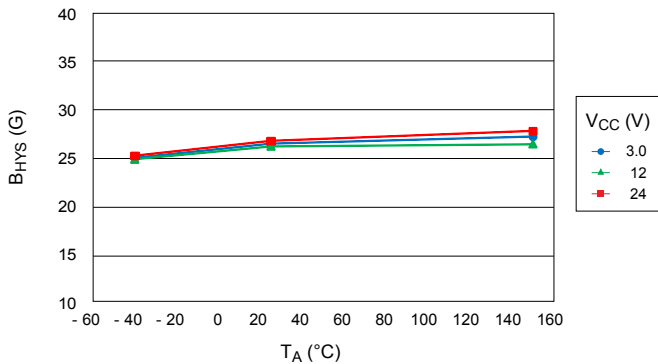

Average Switchpoint Hysteresis versus Supply Voltage

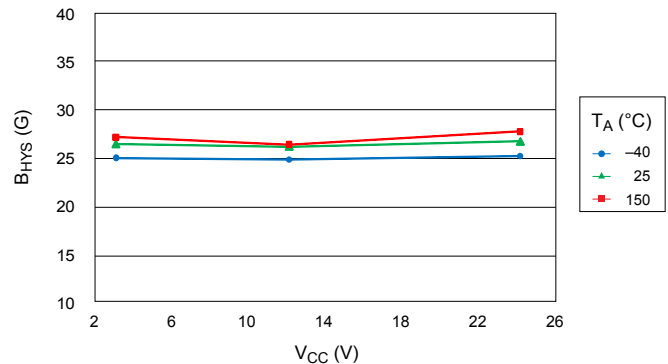

## A1122 Magnetic Characteristics

Average Operate Point versus Ambient Temperature

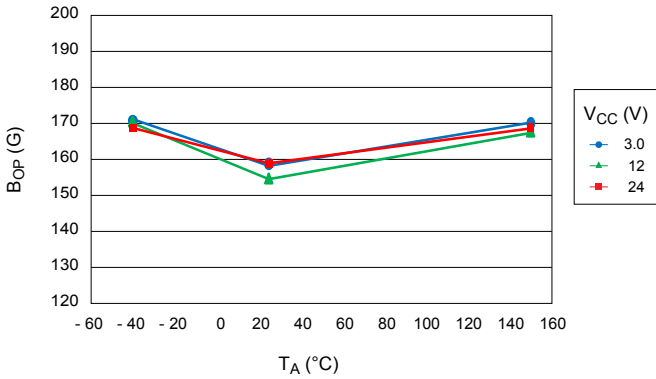

Average Operate Point versus Average Supply Voltage

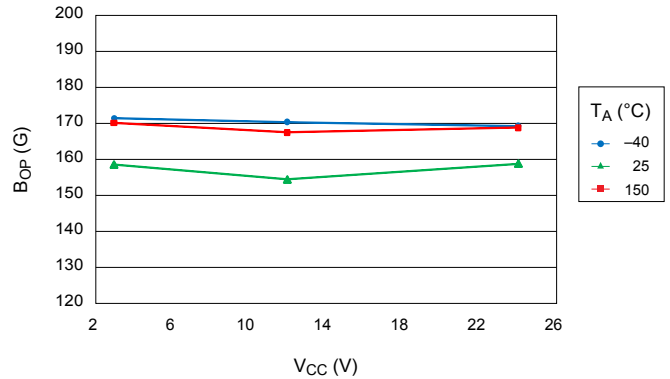

Average Release Point versus Ambient Temperature

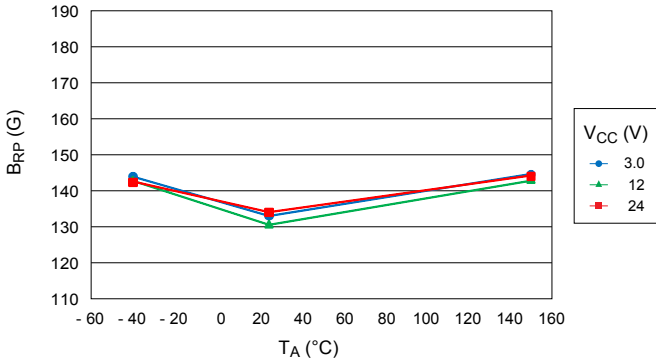

Average Release Point versus Average Supply Voltage

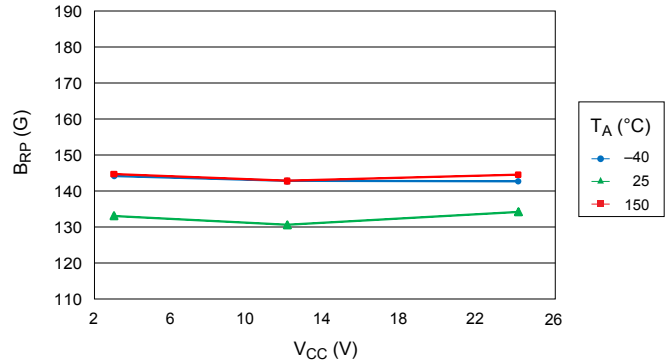

Average Switchpoint Hysteresis versus Ambient Temperature

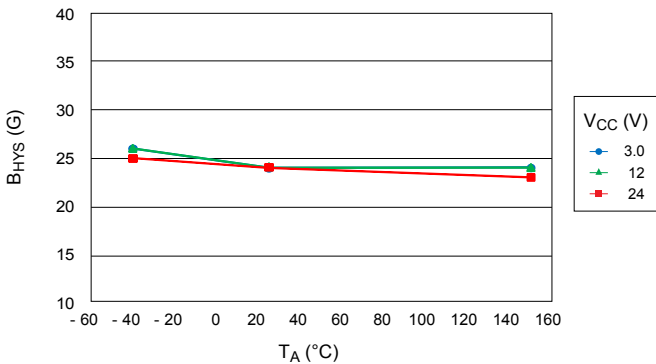

Average Switchpoint Hysteresis versus Supply Voltage

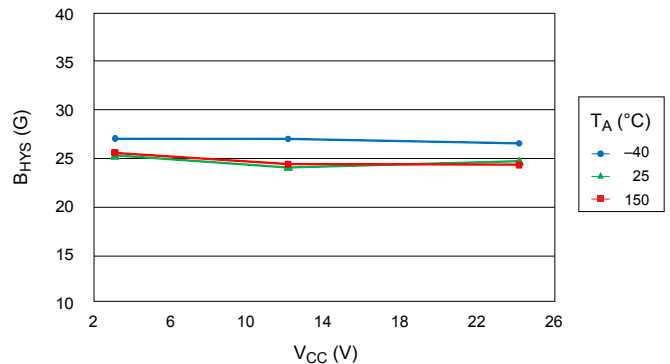

## A1123 Magnetic Characteristics

Average Operate Point versus Ambient Temperature

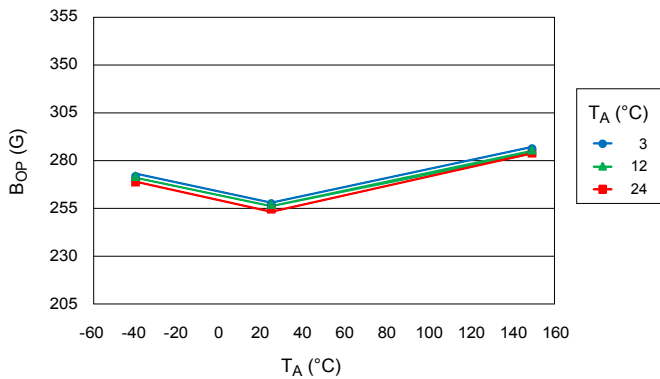

Average Operate Point versus Average Supply Voltage

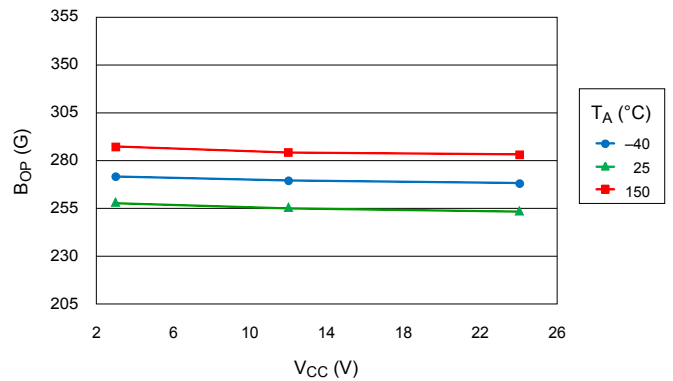

Average Release Point versus Ambient Temperature

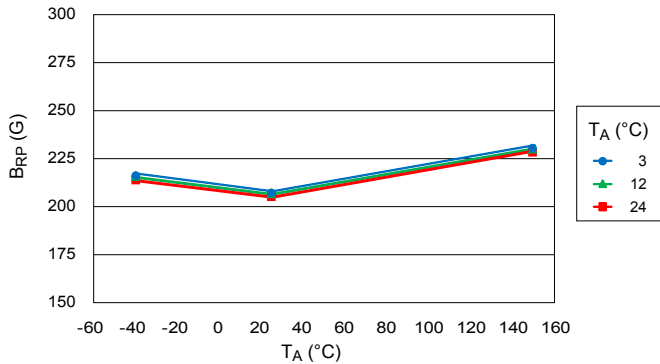

Average Release Point versus Average Supply Voltage

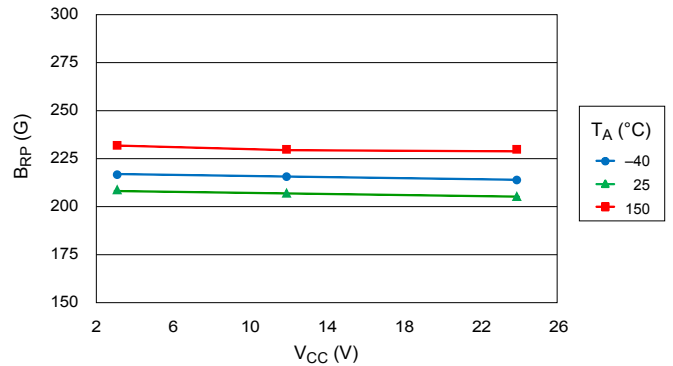

Average Switchpoint Hysteresis versus Ambient Temperature

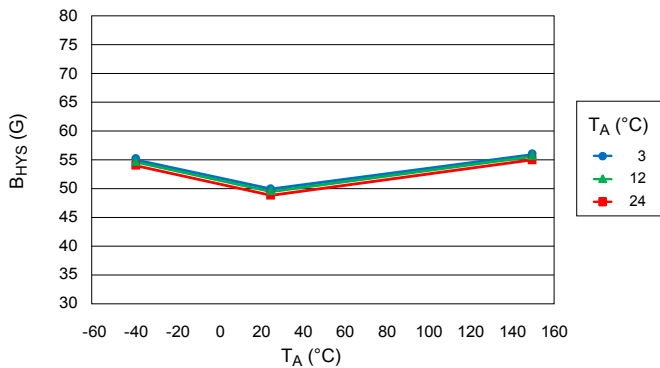

Average Switchpoint Hysteresis versus Supply Voltage

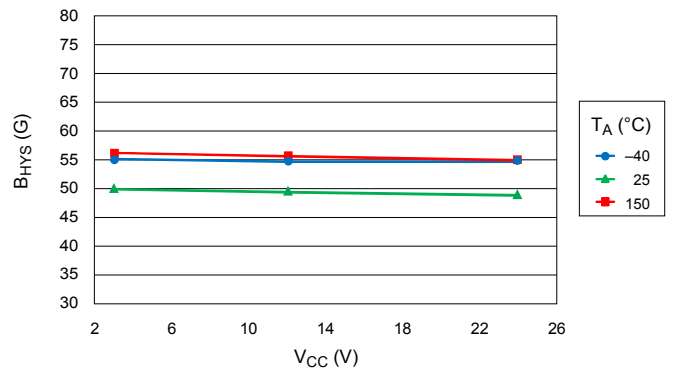

## FUNCTIONAL DESCRIPTION

### Operation

The output of the A1120, A1121, A1122, and A1123 devices switches low (turns on) when a magnetic field perpendicular to the Hall element exceeds the operate point threshold,  $B_{OP}$  (see panel A of figure 1). When the magnetic field is reduced below the release point,  $B_{RP}$ , the device output goes high (turns off). The output of the A1125 devices switches high (turns off) when a magnetic field perpendicular to the Hall element exceeds the operate point threshold,  $B_{OP}$  (see panel B of figure 1). When the magnetic field is reduced below the release point,  $B_{RP}$ , the device output goes low (turns on).

After turn-on, the output voltage is  $V_{OUT(SAT)}$ . The output transistor is capable of sinking current up to the short circuit current limit,  $I_{OM}$ , which is a minimum of 30 mA.

The difference in the magnetic operate and release points is the hysteresis,  $B_{HYS}$ , of the device. This built-in hysteresis allows clean switching of the output even in the presence of external mechanical vibration and electrical noise. Powering-on the device in the hysteresis range (less than  $B_{OP}$  and higher than  $B_{RP}$ ) will

give an indeterminate output state. The correct state is attained after the first excursion beyond  $B_{OP}$  or  $B_{RP}$ .

### Applications

It is strongly recommended that an external bypass capacitor be connected (in close proximity to the Hall element) between the supply and ground of the device to reduce external noise in the application. As is shown in panel B of figure 1, a 0.1  $\mu\text{F}$  capacitor is typical.

Extensive applications information for Hall effect devices is available in:

- *Hall-Effect IC Applications Guide*, Application Note 27701
- *Guidelines for Designing Subassemblies Using Hall-Effect Devices*, Application Note 27703.1
- *Soldering Methods for Allegro's Products – SMT and Through-Hole*, Application Note 26009

All are provided on the Allegro website, [www.allegromicro.com](http://www.allegromicro.com).

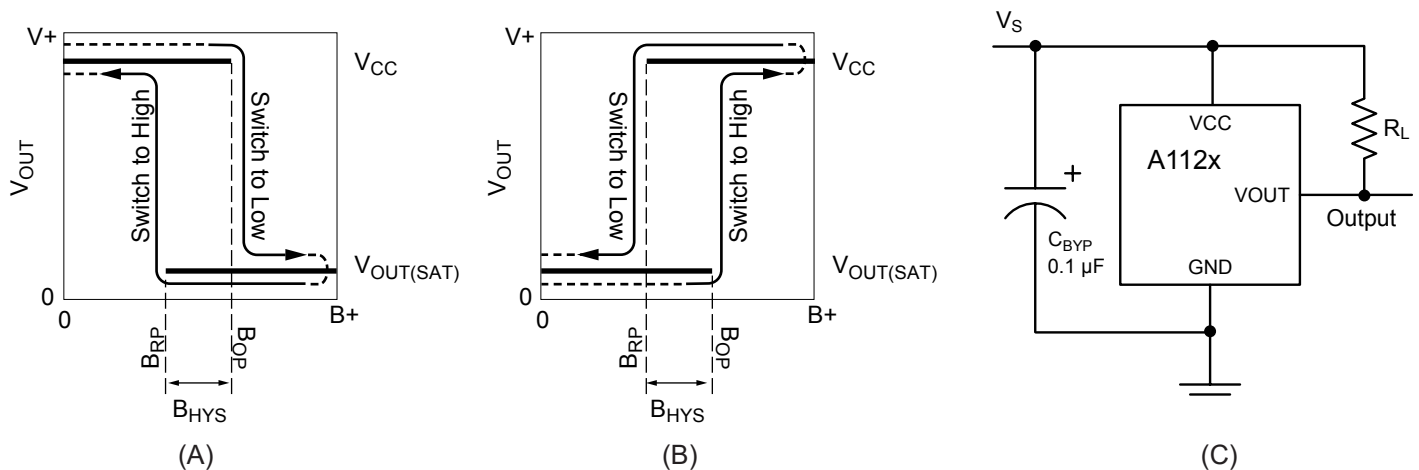

Figure 1. Device switching behavior. In panels A and B, on the horizontal axis, the B+ direction indicates increasing south polarity magnetic field strength. This behavior can be exhibited when using an electrical circuit such as that shown in panel C.

## Chopper Stabilization Technique

When using Hall effect technology, a limiting factor for switchpoint accuracy is the small signal voltage developed across the Hall element. This voltage is disproportionately small relative to the offset that can be produced at the output of the Hall element. This makes it difficult to process the signal while maintaining an accurate, reliable output over the specified operating temperature and voltage ranges.

Chopper stabilization is a unique approach used to minimize Hall offset on the chip. The Allegro technique, namely Dynamic Quadrature Offset Cancellation, removes key sources of the output drift induced by thermal and mechanical stresses. This offset reduction technique is based on a signal modulation-demodulation process. The undesired offset signal is separated from the magnetic field-induced signal in the frequency domain, through modulation. The subsequent demodulation acts as a modulation process for the offset, causing the magnetic field induced signal to recover its original spectrum at baseband, while the dc offset becomes a high-frequency signal. The magnetic sourced signal then can pass through a low-pass filter, while the modulated DC offset is suppressed. This configuration is illustrated in figure 2.

The chopper stabilization technique uses a 400 kHz high frequency clock. For demodulation process, a sample and hold technique is used, where the sampling is performed at twice the chopper frequency (800 kHz). This high-frequency operation allows a greater sampling rate, which results in higher accuracy and faster signal-processing capability. This approach desensitizes the chip to the effects of thermal and mechanical stresses, and produces devices that have extremely stable quiescent Hall output voltages and precise recoverability after temperature cycling. This technique is made possible through the use of a BiCMOS process, which allows the use of low-offset, low-noise amplifiers in combination with high-density logic integration and sample-and-hold circuits.

The repeatability of magnetic field-induced switching is affected slightly by a chopper technique. However, the Allegro high frequency chopping approach minimizes the affect of jitter and makes it imperceptible in most applications. Applications that are more likely to be sensitive to such degradation are those requiring precise sensing of alternating magnetic fields; for example, speed sensing of ring-magnet targets. For such applications, Allegro recommends its digital device families with lower sensitivity to jitter. For more information on those devices, contact your Allegro sales representative.

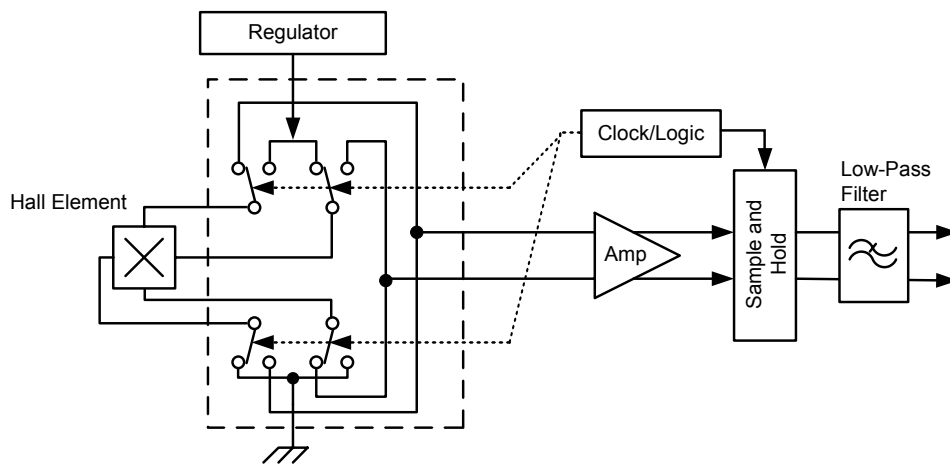

Figure 2. Model of chopper stabilization technique

## Power Derating

The device must be operated below the maximum junction temperature of the device,  $T_{J(\max)}$ . Under certain combinations of peak conditions, reliable operation may require derating supplied power or improving the heat dissipation properties of the application. This section presents a procedure for correlating factors affecting operating  $T_J$ . (Thermal data is also available on the Allegro MicroSystems website.)

The Package Thermal Resistance,  $R_{\theta JA}$ , is a figure of merit summarizing the ability of the application and the device to dissipate heat from the junction (die), through all paths to the ambient air. Its primary component is the Effective Thermal Conductivity,  $K$ , of the printed circuit board, including adjacent devices and traces. Radiation from the die through the device case,  $R_{\theta JC}$ , is relatively small component of  $R_{\theta JA}$ . Ambient air temperature,  $T_A$ , and air motion are significant external factors, damped by overmolding.

The effect of varying power levels (Power Dissipation,  $P_D$ ), can be estimated. The following formulas represent the fundamental relationships used to estimate  $T_J$ , at  $P_D$ .

$$P_D = V_{IN} \times I_{IN} \quad (1)$$

$$\Delta T = P_D \times R_{\theta JA} \quad (2)$$

$$T_J = T_A + \Delta T \quad (3)$$

For example, given common conditions such as:  $T_A = 25^\circ\text{C}$ ,  $V_{CC} = 12\text{ V}$ ,  $I_{CC} = 1.6\text{ mA}$ , and  $R_{\theta JA} = 165^\circ\text{C/W}$ , then:

$$P_D = V_{CC} \times I_{CC} = 12\text{ V} \times 1.6\text{ mA} = 19\text{ mW}$$

$$\Delta T = P_D \times R_{\theta JA} = 19\text{ mW} \times 165^\circ\text{C/W} = 3^\circ\text{C}$$

$$T_J = T_A + \Delta T = 25^\circ\text{C} + 3^\circ\text{C} = 28^\circ\text{C}$$

A worst-case estimate,  $P_{D(\max)}$ , represents the maximum allowable power level ( $V_{CC(\max)}$ ,  $I_{CC(\max)}$ ), without exceeding  $T_{J(\max)}$ , at a selected  $R_{\theta JA}$  and  $T_A$ .

*Example:* Reliability for  $V_{CC}$  at  $T_A = 150^\circ\text{C}$ , package LH, using a minimum-K PCB.

Observe the worst-case ratings for the device, specifically:  $R_{\theta JA} = 228^\circ\text{C/W}$ ,  $T_{J(\max)} = 165^\circ\text{C}$ ,  $V_{CC(\max)} = 24\text{ V}$ , and  $I_{CC(\max)} = 4\text{ mA}$ .

Calculate the maximum allowable power level,  $P_{D(\max)}$ . First, invert equation 3:

$$\Delta T_{\max} = T_{J(\max)} - T_A = 165^\circ\text{C} - 150^\circ\text{C} = 15^\circ\text{C}$$

This provides the allowable increase to  $T_J$  resulting from internal power dissipation. Then, invert equation 2:

$$P_{D(\max)} = \Delta T_{\max} \div R_{\theta JA} = 15^\circ\text{C} \div 228^\circ\text{C/W} = 66\text{ mW}$$

Finally, invert equation 1 with respect to voltage:

$$V_{CC(\text{est})} = P_{D(\max)} \div I_{CC(\max)} = 66\text{ mW} \div 4\text{ mA} = 16.5\text{ V}$$

The result indicates that, at  $T_A$ , the application and device can dissipate adequate amounts of heat at voltages  $\leq V_{CC(\text{est})}$ .

Compare  $V_{CC(\text{est})}$  to  $V_{CC(\max)}$ . If  $V_{CC(\text{est})} \leq V_{CC(\max)}$ , then reliable operation between  $V_{CC(\text{est})}$  and  $V_{CC(\max)}$  requires enhanced  $R_{\theta JA}$ . If  $V_{CC(\text{est})} \geq V_{CC(\max)}$ , then operation between  $V_{CC(\text{est})}$  and  $V_{CC(\max)}$  is reliable under these conditions.

## Package LH, 3-Pin (SOT-23W)

### For Reference Only – Not for Tooling Use

(Reference Allegro DWG-0000628, Rev. 1)

NOT TO SCALE

Dimensions in millimeters

Dimensions exclusive of mold flash, gate burrs, and dambar protrusions  
Exact case and lead configuration at supplier discretion within limits shown

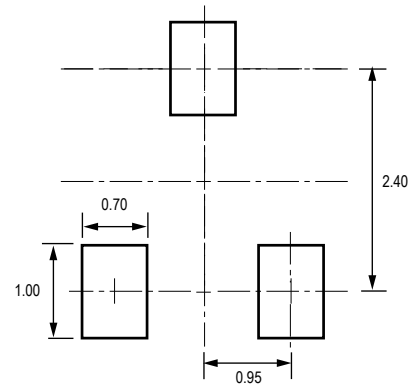
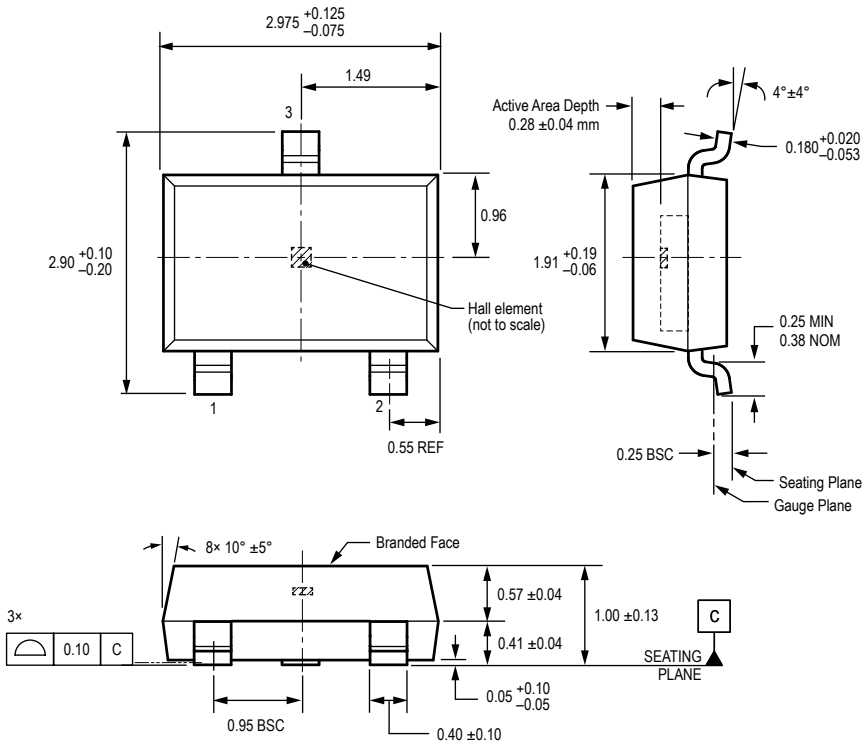

PCB Layout Reference View

All pads a minimum of 0.20 mm from all adjacent pads; adjust as necessary to meet application process requirements and PCB layout tolerances

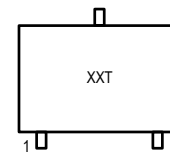

Standard Branding Reference View 1

Line 1 = 3 characters

Line 1: Last 2 digits of Part Number,  
Temperature Code (letter)

Branding scale and appearance at supplier discretion

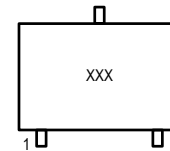

Standard Branding Reference View 2

Line 1 = 3 characters

Line 1: Last 3 digits of Part Number

Branding scale and appearance at supplier discretion

## Package UA, 3-Pin SIP, Matrix Style

### For Reference Only – Not For Tooling Use

(Reference DWG-0000404, Rev. 1)

NOT TO SCALE

Dimensions in millimeters

Exact case and lead configuration at supplier discretion within limits shown

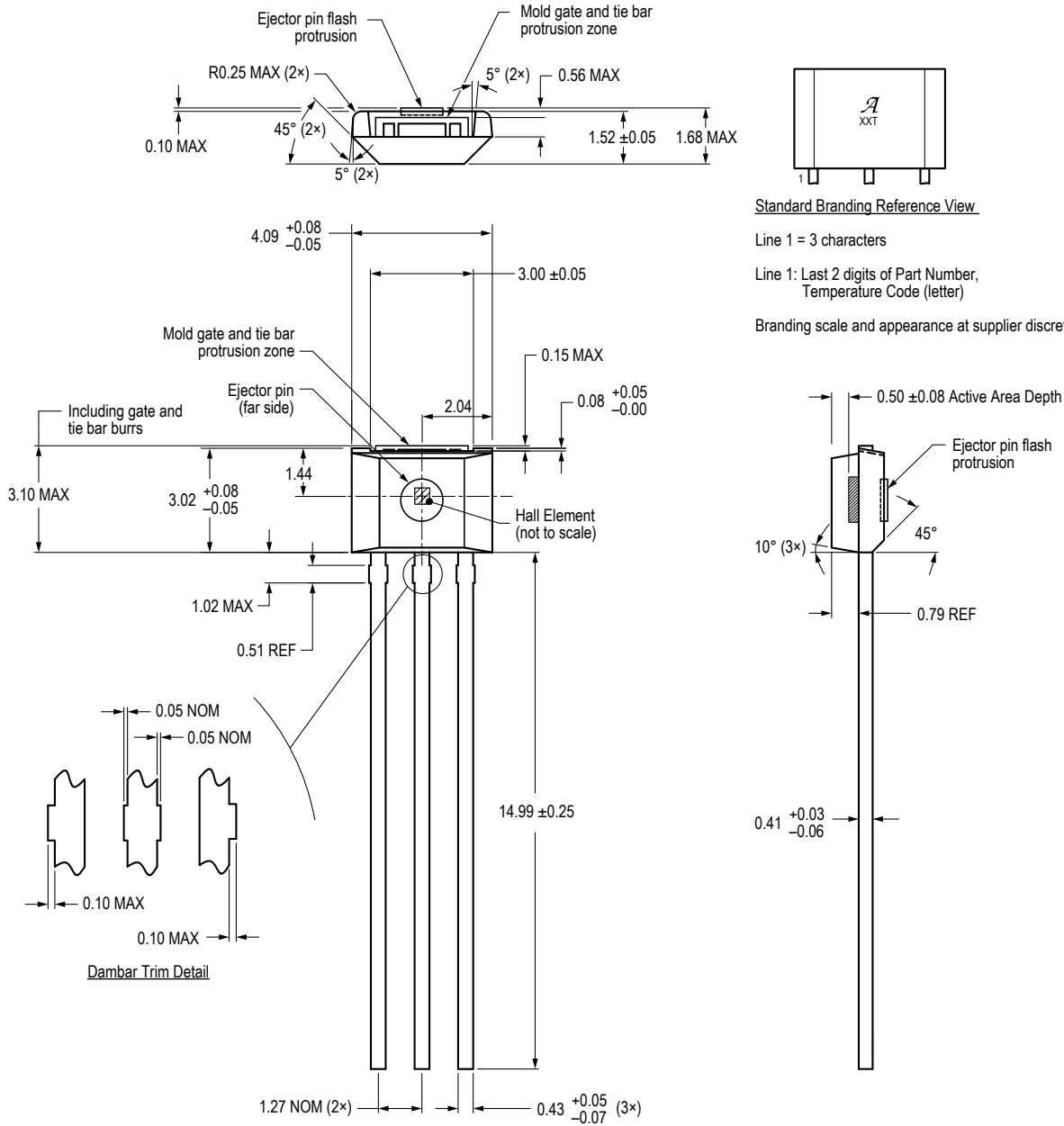

Standard Branding Reference View

Line 1 = 3 characters

Line 1: Last 2 digits of Part Number,  
Temperature Code (letter)

Branding scale and appearance at supplier discretion



## Package UA, 3-Pin SIP, Chopper Style

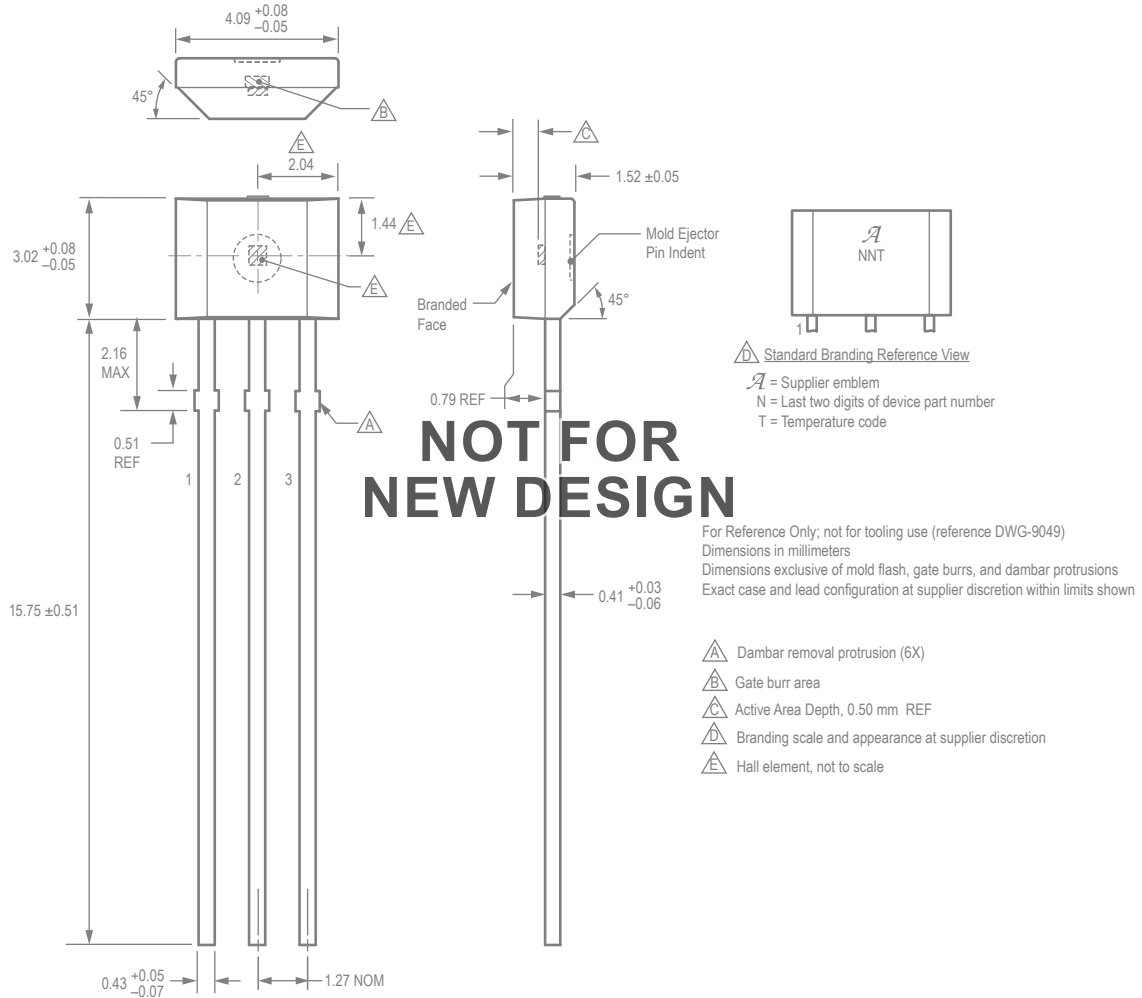

## Revision History

Number	Date	Description
15	September 3, 2013	Update product offerings; Update UA package drawing
16	September 16, 2015	Added AEC-Q100 qualification under Features and Benefits
17	November 4, 2016	Chopper-style UA package designated as not for new design
18	February 15, 2019	Minor editorial updates
19	March 6, 2020	Minor editorial updates
20	March 3, 2022	Updated package drawings (pages 15-16)

Copyright 2022, Allegro MicroSystems.

Allegro MicroSystems reserves the right to make, from time to time, such departures from the detail specifications as may be required to permit improvements in the performance, reliability, or manufacturability of its products. Before placing an order, the user is cautioned to verify that the information being relied upon is current.

Allegro's products are not to be used in any devices or systems, including but not limited to life support devices or systems, in which a failure of Allegro's product can reasonably be expected to cause bodily harm.

The information included herein is believed to be accurate and reliable. However, Allegro MicroSystems assumes no responsibility for its use; nor for any infringement of patents or other rights of third parties which may result from its use.

Copies of this document are considered uncontrolled documents.

For the latest version of this document, visit our website:

[www.allegromicro.com](http://www.allegromicro.com)

## X-ON Electronics

Largest Supplier of Electrical and Electronic Components

*Click to view similar products for [Board Mount Hall Effect/Magnetic Sensors](#) category:*

*Click to view products by [Allegro](#) manufacturer:*

Other Similar products are found below :

[HGPRDT005A](#) [AH1894-FA-7](#) [AH277AZ4-AG1](#) [AV-10448](#) [SS41C](#) [AH1894-Z-7](#) [TLE4917](#) [TLE4946-1L](#) [TLE4976L](#) [SS85CA](#)  
[BU52003GUL-E2](#) [AH277AZ4-BG1](#) [AH3376-P-B](#) [TLE4941](#) [TLE4945-2L](#) [AH3360-FT4-7](#) [TLE4941-1](#) [AH374-P-A](#) [SS41-JL](#) [AH1913-W-7](#)  
[AH3373-P-B](#) [MA732GQ-Z](#) [MA330GQ-Z](#) [S-57K1NBL2A-M3T2U](#) [S-57P1NBL9S-M3T4U](#) [S-576ZNL2B-L3T2U](#) [S-576ZNL2B-A6T8U](#) [S-](#)  
[57P1NBL0S-M3T4U](#) [S-57A1NSL1A-M3T2U](#) [S-57K1RBL1A-M3T2U](#) [S-57P1NBH9S-M3T4U](#) [S-57P1NBH0S-M3T4U](#) [S-57A1NSH1A-](#)  
[M3T2U](#) [S-57A1NSH2A-M3T2U](#) [S-57K1NBH1A-M3T2U](#) [S-57A1NNL1A-M3T2U](#) [S-5701BC11B-L3T2U5](#) [S-57GNNL3S-A6T8U](#) [S-](#)  
[57TZ1L1S-A6T8U](#) [S-57GSNL3S-A6T8U](#) [S-5716ANDH0-I4T1U](#) [S-57GSNL5S-L3T2U](#) [S-57GDNL3S-L3T2U](#) [S-57GNNL3S-L3T2U](#) [S-](#)  
[57RBNL8S-L3T2U](#) [S-57RBNL9S-A6T8U](#) [S-57RB1L8S-L3T2U](#) [S-57GDNL5S-L3T2U](#) [S-57RBNL9S-L3T2U](#) [S-57TZ1L1S-L3T2U](#)