

3D Hall-Effect Sensor IC with Sine/Cosine Outputs

FEATURES AND BENEFITS

- 5 V supply voltage
- Tiny SOT23-W
- Pre-programmed axis combinations: XY, XZ, or YZ
- Ratiometric outputs
- Low output current
- Two selectable sensitivities
- AEC-Q100 grade 0 automotive qualified
- Quality managed (QM)

PACKAGE:

5-Pin SOT23-W (Suffix LH)

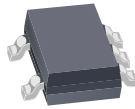

Not to scale

DESCRIPTION

The A33230 is an integrated circuit (IC) 3D Hall-effect sensor IC intended for position sensing of magnet targets. The IC incorporates vertical and planar Hall-effect elements with sensing axes that are orthogonal to one another, providing 90° phase separation. This phase separation is inherently independent of magnet pole spacing and air gap.

The IC comes pre-programmed to XY, XZ, or YZ combinations while providing independent sine and cosine outputs. User-defined linearization and error compensation may be required.

The A33230 is provided in a 5-pin SOT23-W package (suffix LH). The package is RoHS compliant and lead (Pb) free with a 100% matte-tin leadframe plating.

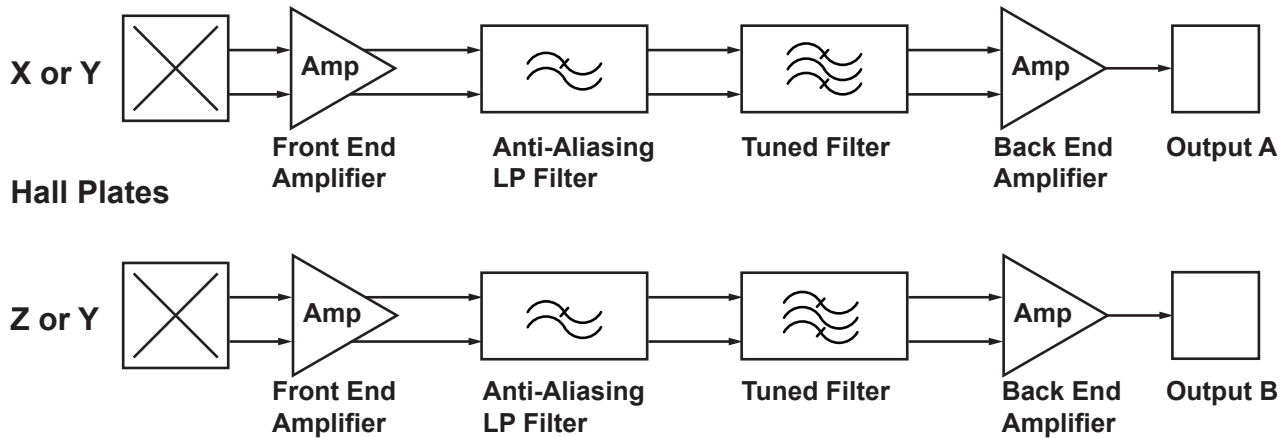

Figure 1: Functional Block Diagram

A33230

3D Hall-Effect Sensor IC with Sine/Cosine Outputs

SELECTION GUIDE

Part Number	Application	Number of Die	Package	Packing
A33230LLHALT-XY-S-AR-03	XY	300 G	5-pin SOT23-W (suffix LH)	3000 pieces per 7-inch reel
A33230LLHALT-XY-S-AR-10		1000 G		
A33230LLHALT-XZ-S-AR-03	XZ	300 G		
A33230LLHALT-XZ-S-AR-10		1000 G		
A33230LLHALT-YZ-S-AR-03	YZ	300 G		
A33230LLHALT-YZ-S-AR-10		1000 G		

[1] For other package options, contact Allegro.

ABSOLUTE MAXIMUM RATINGS

Characteristic	Symbol	Notes	Rating	Unit
Forward Supply Voltage	V_{CC}		7	V
Reverse Supply Voltage	V_{RCC}		-0.1	V
Forward Output Voltage	V_{OUT}		7	V
Reverse Output Voltage	V_{ROUT}		-0.1	V
Output Source Current	$I_{OUT(SOURCE)}$	VOUT to GND	1	mA
Output Sink Current	$I_{OUT(SINK)}$	VCC to VOUT	10	mA
Operating Ambient Temperature	T_A		-40 to 150	°C
Maximum Junction Temperature	$T_{J(max)}$		165	°C
Storage Temperature	T_{stg}		-65 to 170	°C

THERMAL CHARACTERISTICS: May require derating at maximum conditions; see application information

Characteristic	Symbol	Test Conditions*	Value	Unit
Package Thermal Resistance	$R_{\theta JA}$	Package LH-5 4-layer PCB based on JEDEC standard JESD51-7	124	°C/W

*Additional thermal information available on the Allegro website.

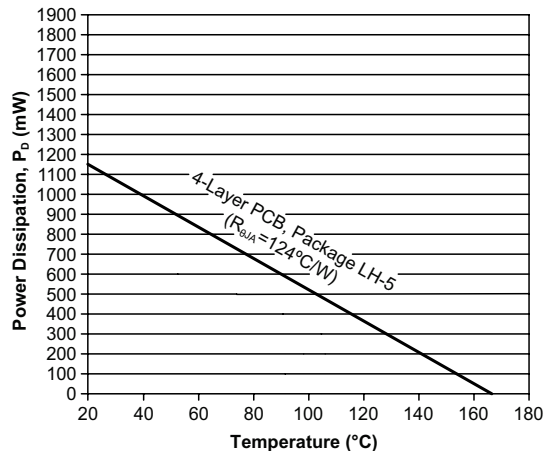

Maximum Power Dissipation versus Ambient Temperature

PINOUT DIAGRAM AND LIST

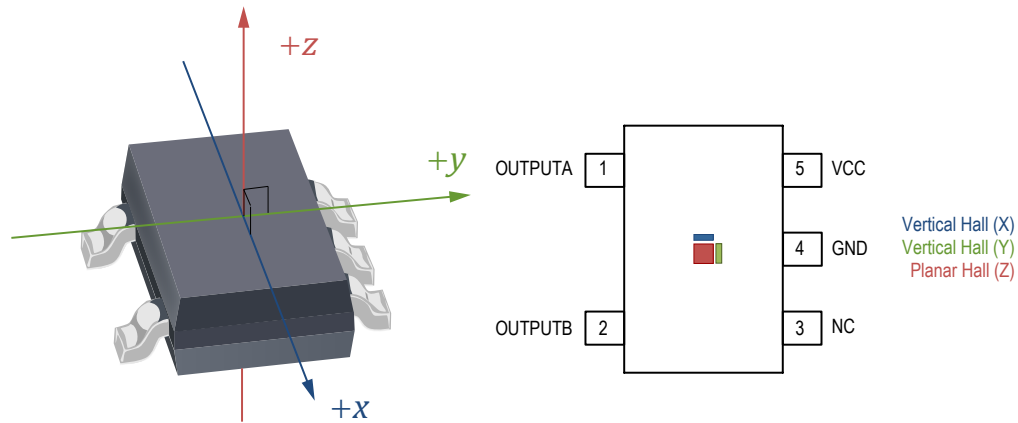

LH-5 Package Pinouts

Pinout List

Number	Name	Function
1	OUTPUTA	Cosine/Sine Output
2	OUTPUTB	Cosine/Sine Output
3	NC	Not Connected (Connect to GND for optimal EMC performance)
4	GND	Ground
5	VCC	Supply Voltage

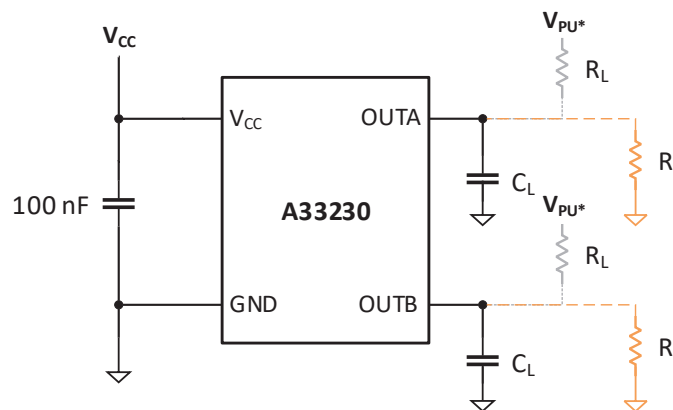

Figure 2: Typical Application Circuit

The load capacitance is optional for best noise performances. Typical value for C_L is 1 nF. The load resistors are also optional with a pull-up configuration (gray) or a pull-down configuration (orange).

$$* V_{PU} \leq V_{CC}$$

OPERATING CHARACTERISTICS: Valid over operating voltage and temperatures, unless otherwise specified

Characteristics	Symbol	Test Conditions	Min.	Typ. [1]	Max.	Unit	
ELECTRICAL SUPPLY CHARACTERISTICS							
Supply Voltage	V_{CC}		4.5	5.0	5.5	V	
Supply Current	I_{CC}	No load	–	7.0	10	mA	
Output Source Current	I_{SOURCE}	$R_L = 8\text{ k}\Omega$	–	0.5	–	mA	
Output Sink Current	I_{SINK}	$R_L = 8\text{ k}\Omega$	–	0.5	–	mA	
ELECTRICAL PROTECTION CHARACTERISTICS							
Supply Zener Clamp Voltage	$V_{ZSUPPLY}$	$I_{CC} = I_{CC(MAX)} + 5\text{ mA}$	7	–	–	V	
Reverse Supply Zener Clamp Voltage	$V_{RZSUPPLY}$	$I_{CC} = -1\text{ mA}$	–	–	-0.1	V	
POWER-ON STATE CHARACTERISTICS							
Power-On Time [2]	t_{PO}	Time from $V_{CC} \geq V_{CC(min)}$ to when OUTPUTA and OUTPUTB are >90% of steady-state value	–	25	60	μs	
OUTPUT CHARACTERISTICS							
Voltage Range [2]	$V_{OUT(SAT)HIGH}$	$I_{OUT} = 550\text{ }\mu\text{A}$	$V_{CC} - 0.5$	–	–	V	
	$V_{OUT(SAT)LOW}$	$I_{OUT} = -550\text{ }\mu\text{A}$	–	–	0.5	V	
Input Magnetic Flux Density [2][3]	B	1000 G option	–	1000	1200	G	
		300 G option	–	300	400	G	
Quiescent Voltage Output (QVO)	$V_{OUT(Q)}$		–	$V_{CC} / 2$	–	V	
QVO Error	$V_{ERROUT(Q)}$	$T_A = 25^\circ\text{C}$	-70	–	70	mV	
		$T_A = -40^\circ\text{C}$ to 150°C	-125	–	125	mV	
Sensitivity	Sens	$V_{CC} = 5\text{ V}$ [4], 1000 G option, $T_A = 25^\circ\text{C}$	0.9	1.2	1.5	mV/G	
		$V_{CC} = 5\text{ V}$ [4], 300 G option, $T_A = 25^\circ\text{C}$	2.7	3.6	4.5	mV/G	
Sensitivity Mismatch	MM_{SENS}	$(Sens_B - Sens_A) / Sens_A \times 100\%$	–	± 3	–	%	
Orthogonality Error	OG	Phase difference between sine and cosine signals ($OG = \phi_C - \phi_S$)	–	± 1	–	degrees	
Input Referred Noise Density	σ	OUTA and OUTB, 1σ	$T_A = 25^\circ\text{C}$	–	4.5	–	$\text{mG}_{rms} / \sqrt{\text{Hz}}$
			$T_A = 150^\circ\text{C}$	–	8.25	–	$\text{mG}_{rms} / \sqrt{\text{Hz}}$
Output Effective Resolution	ER	$ B = 1000\text{ G}$, 1σ , $BW = 50\text{ kHz}$	$T_A = 25^\circ\text{C}$	–	11	–	bits
			$T_A = 150^\circ\text{C}$	–	10	–	bits
		$ B = 300\text{ G}$, 1σ , $BW = 50\text{ kHz}$	$T_A = 25^\circ\text{C}$	–	9	–	bits
			$T_A = 150^\circ\text{C}$	–	8	–	bits
Slew Rate [5]	SR	$C_L = 5\text{ nF}$	100	–	–	kV/s	
Response Time [5]	t_R	Time from input magnetic sinusoidal stimulus to output response; $BW = 50\text{ kHz}$	–	6.7	–	μs	
Bandwidth [5]	BW		35	50	75	kHz	

[1] Typical values at $V_{CC} = 5\text{ V}$ and $T_A = 25^\circ\text{C}$, unless otherwise specified. Performance may vary for individual units, within the minimum and maximum limits.

[2] Specification is guaranteed by design and characterization.

[3] Input Magnetic Flux Density can exceed the maximum limit presented in the table without damaging the device. Device channel linearity error will deteriorate if the limit is exceeded.

[4] Sensitivity of the device will change with V_{CC} because the output is ratiometric. If V_{CC} is different from 5 V, use the following equation to solve for the sensitivity: $Sens_{(V_{CC})} = Sens_{(5V)} \times V_{CC} / 5\text{ V}$.

[5] Specification is guaranteed by design.

Continued on next page...

OPERATING CHARACTERISTICS (continued): Valid over operating voltage and temperatures, unless otherwise specified

Characteristics	Symbol	Test Conditions	Min.	Typ. [1]	Max.	Unit	
ACCURACY PERFORMANCE							
Channel Linearity Error	ERR_{LIN}	Error of device output relative to an ideal output; $ B_{APPLIED} \leq B_{MAX} $	-0.3	-	0.3	%	
Offset Ratiometry Error	$ERR_{RAT(QVO)}$	Error of $V_{OUT(Q)}$ relative to a perfectly ratiometric response for $V_{CC} = 5 V \pm 0.5 V$, relative to 5 V	-1	-	1	%	
Sensitivity Ratiometry Error	$ERR_{RAT(SENS)}$	Error of Sens relative to a perfectly ratiometric response for $V_{CC} = 5 V \pm 0.5 V$, relative to 5 V	-5	-	5	%	
Angle Micro-Linearity Error	$ERR_{\mu LIN(\theta)}$	Over 1° input range; $ B = 300 G$; Typ. = 3σ	-	± 0.15	-	degrees	
ANGLE PERFORMANCE							
Native Angle Error [2][3][4]	$ERR_{ANG(NAT,300)}$	No Correction [6], RPM = 0	Valid for $ B = 300 G$	-6.1	± 2.2	6.1	degrees
	$ERR_{ANG(NAT,1000)}$ [5]		Valid for $ B = 1000 G$	-3.3	± 1.2	3.3	degrees
One Time External Correction [2][3][4]	$ERR_{ANG(OT,300)}$	Ideal External Offset, Amplitude, and Phase correction at $T_A = 25^\circ C$, RPM = 0	Valid for $ B = 300 G$	-5.1	± 1.8	5.1	degrees
	$ERR_{ANG(OT,1000)}$ [5]		Valid for $ B = 1000 G$	-2.9	± 1.0	2.9	degrees
Dynamic External Correction [2][3][4]	$ERR_{ANG(DYN)}$	Ideal External Phase correction at $T_A = 25^\circ C$ with Cycle-by-Cycle Offset and Amplitude Correction; RPM = 0	Valid for both $ B = 300 G$ and $ B = 1000 G$	-0.7	± 0.2	0.7	degrees
Harmonic Distortion Error	$ERR_{ANG(HD)}$	Resulting Error after Ideal External Offset, Amplitude, and Phase Correction; RPM = 0	-	± 0.2	-	degrees	
Angle Noise [7]	σ_θ	$ B = 1000 G$	$T_A = 25^\circ C$	-	0.07	-	°RMS
			$T_A = 150^\circ C$	-	0.13	-	°RMS
		$ B = 300 G$	$T_A = 25^\circ C$	-	0.24	-	°RMS
			$T_A = 150^\circ C$	-	0.44	-	°RMS
Angle Effective Resolution [7]	ER_θ	$\log_2(360/\sigma_\theta)$, $ B = 1000 G$	$T_A = 25^\circ C$	-	12	-	bits
			$T_A = 150^\circ C$	-	11	-	bits
		$\log_2(360/\sigma_\theta)$, $ B = 300 G$	$T_A = 25^\circ C$	-	10	-	bits
			$T_A = 150^\circ C$	-	9	-	bits
OUTPUT REQUIREMENTS							
Output Load Capacitance [8]	C_L	Capacitance between each output and ground	0	-	5	nF	
Output Load Resistance [8]	R_L	Resistance between each output and ground	8	-	∞	k Ω	

[1] Typical values at $V_{CC} = 5.0 V$ and $T_A = 25^\circ C$, unless otherwise specified.

Performance may vary for individual units, within the minimum and maximum limits.

[2] The angle accuracy depends on the magnetic system, calibration procedure, and the compensation method of the ECU.

[3] Parameters are valid over operating temperature and operating voltage. A total population of 180 devices consisting of three unique wafer fabrication lots were used.

[4] Specification maximum value is equal to the mean of the absolute maximum angle error plus three sigma. This value is determined by characterization.

[5] Specification maximum value is interpolated based off silicon evaluation measurements. This value is determined by characterization.

[6] Native Angle Error specification assumes both voltage outputs are reduced by $V_{CC}/2$ for the arctangent CORDIC calculation.

[7] Theoretical value derived from the output referred noise.

[8] Specification is guaranteed by design.

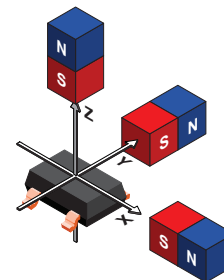

South polarity magnetic fields, in the orientations illustrated (above), are considered positive fields.

CHARACTERISTIC PLOTS

Offset Error

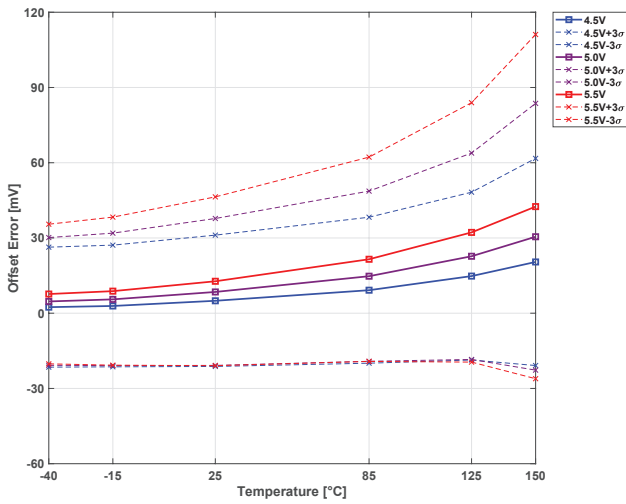

Figure 3: Average X,Y Offset Error $\pm 3\sigma$ over Temperature and V_{CC}

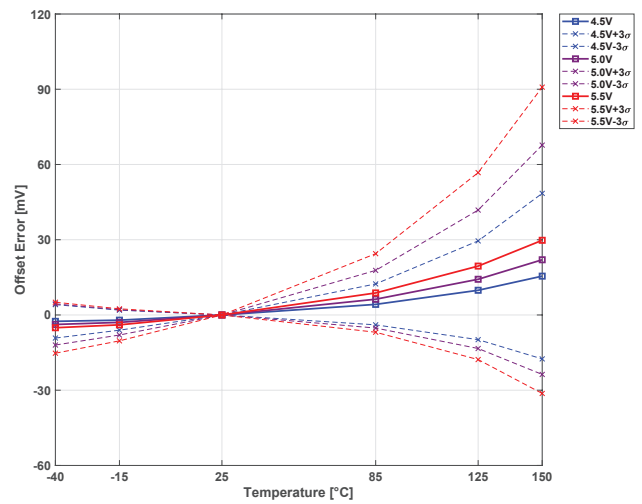

Figure 4: Average X,Y Offset Error Temperature Drift $\pm 3\sigma$ over Temperature and V_{CC}

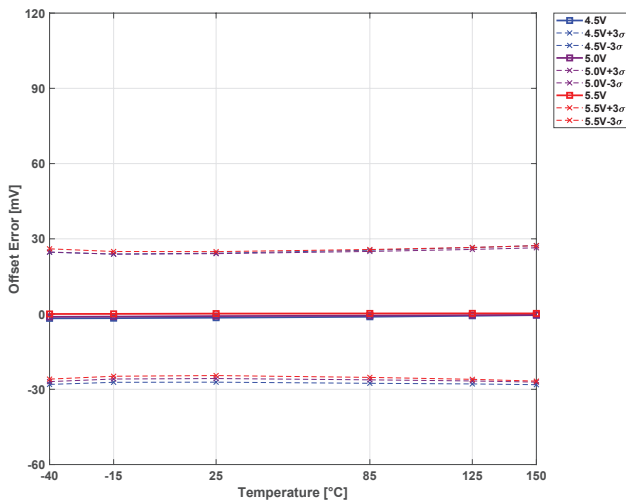

Figure 5: Average Z Offset Error $\pm 3\sigma$ over Temperature and V_{CC}

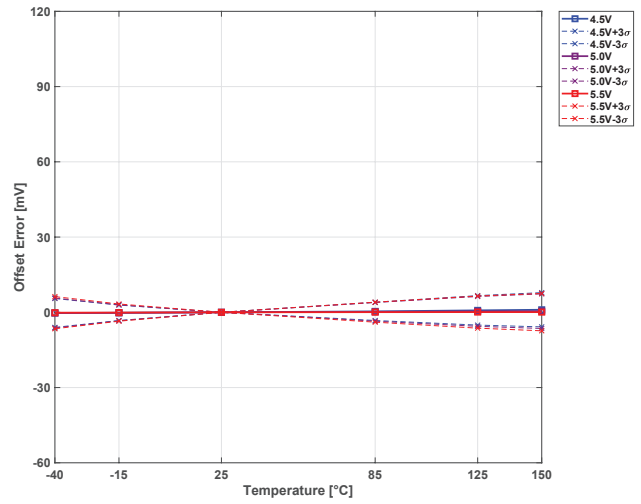

Figure 6: Average Z Offset Error Temperature Drift $\pm 3\sigma$ over Temperature and V_{CC}

CHARACTERISTIC PLOTS (continued)

Sensitivity

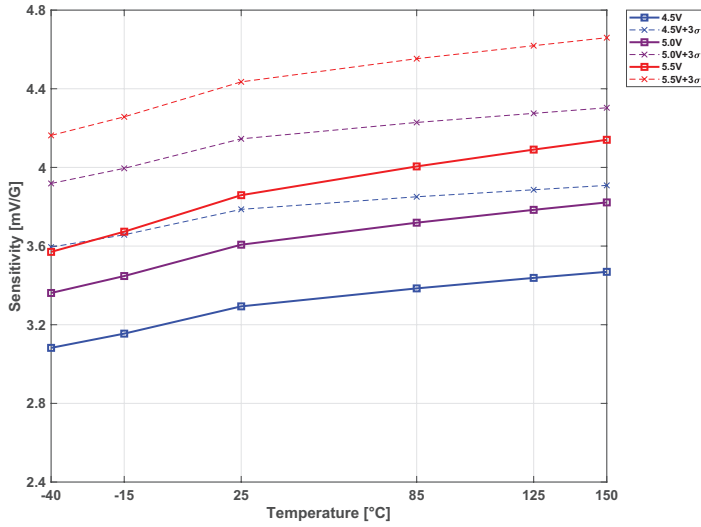

Figure 7: 300 G Option, Average Sensitivity +3σ over Temperature and V_{CC}

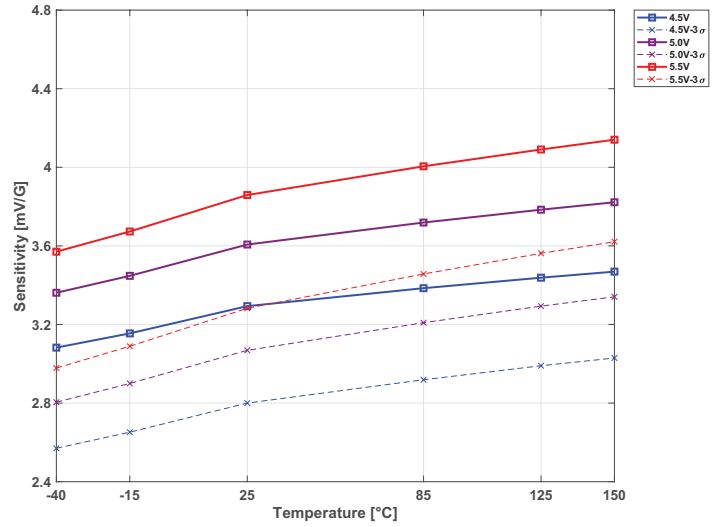

Figure 8: 300 G Option, Average Sensitivity -3σ over Temperature and V_{CC}

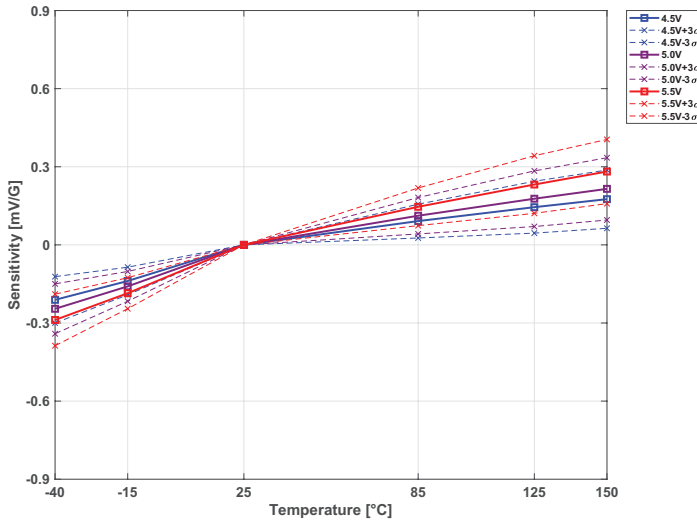

Figure 9: 300 G Option, Average X,Y Sensitivity Temperature Drift +3σ over Temperature and V_{CC}

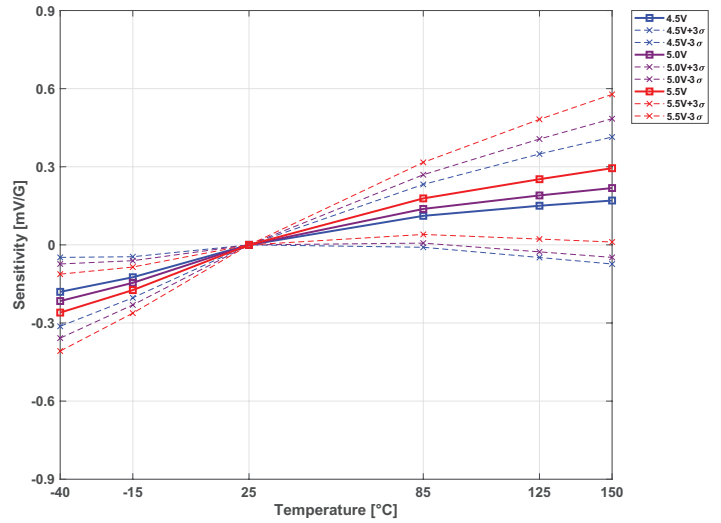

Figure 10: 300 G Option, Average Z Sensitivity Temperature Drift +3σ over Temperature and V_{CC}

CHARACTERISTIC PLOTS (continued)

Angle Performance

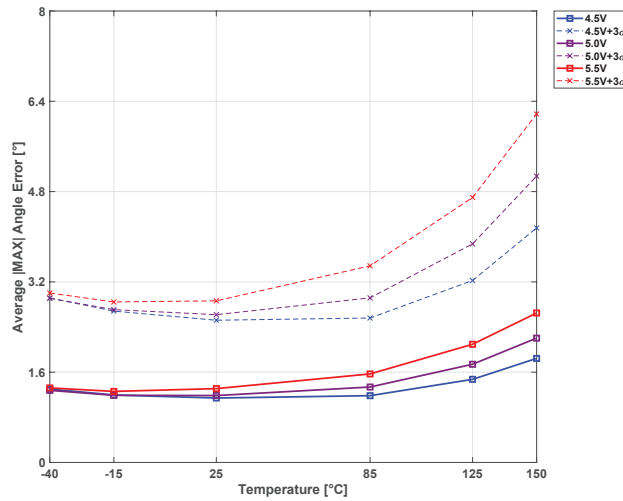

Figure 11: Average |Max| Native Angle Error $\pm 3\sigma$ over Temperature and V_{CC}

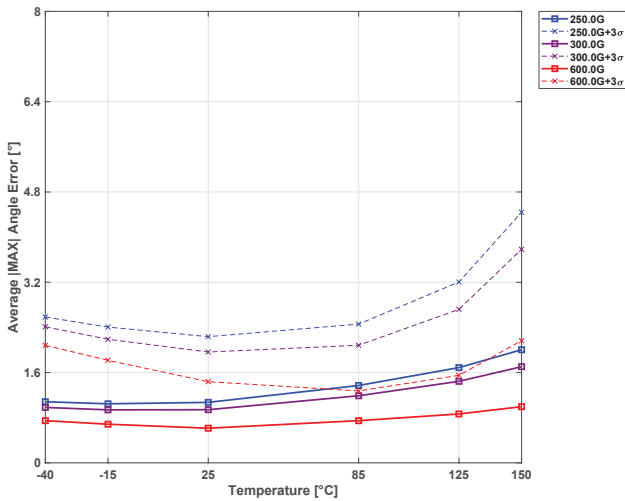

Figure 12: 300 G Option, Average |Max| Native Angle Error $\pm 3\sigma$ over Temperature and Field [1]

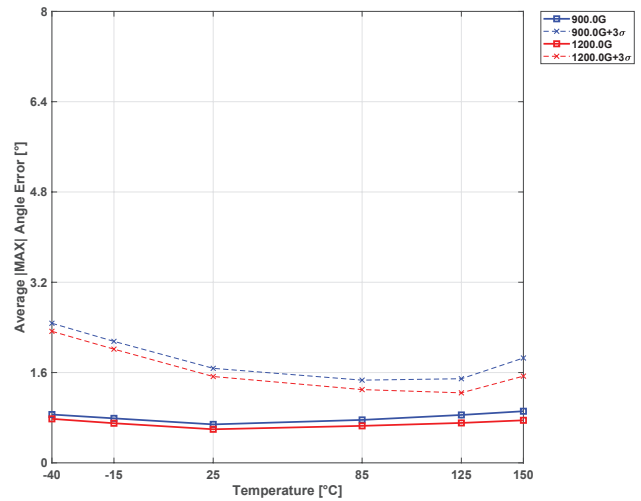

Figure 13: 1000 G Option, Average |Max| Native Angle Error $\pm 3\sigma$ over Temperature and Field [1]

[1] The data represented in Figure 12 and Figure 13 is meant to show a characteristic trend in behavior over magnetic field, not to guarantee performance by characterization.

CHARACTERISTIC PLOTS (continued)

Angle Performance (continued)

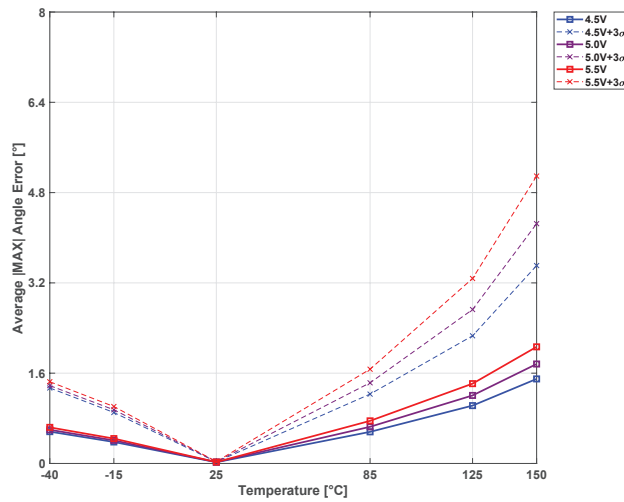

Figure 14: Average |Max| One Time Correction Angle Error +3σ over Temperature and V_{CC}

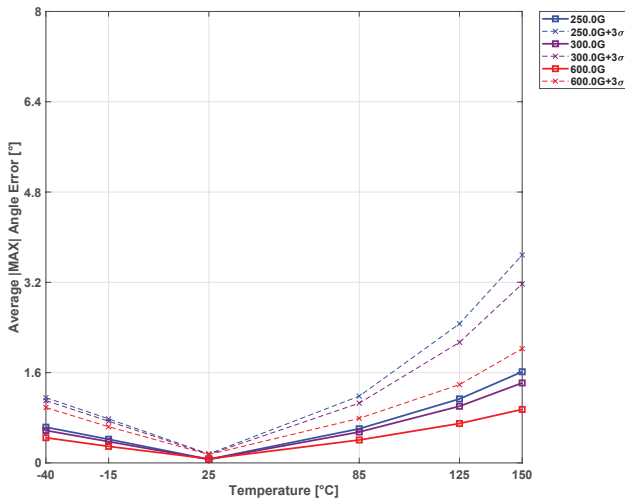

Figure 15: 300 G Option, Average |Max| One Time Correction Angle Error +3σ over Temperature and Field [1]

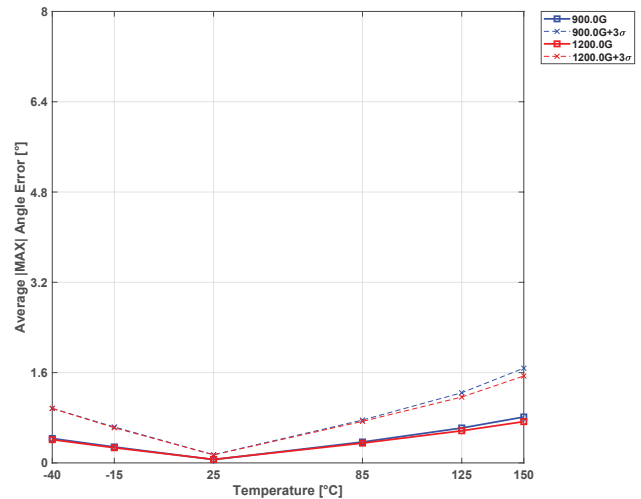

Figure 16: 1000 G Option, Average |Max| One Time Correction Angle Error +3σ over Temperature and Field [1]

[1] The data represented in Figure 15 and Figure 16 is meant to show a characteristic trend in behavior over magnetic field, not to guarantee performance by characterization.

CHARACTERISTIC PLOTS (continued)

Angle Performance (continued)

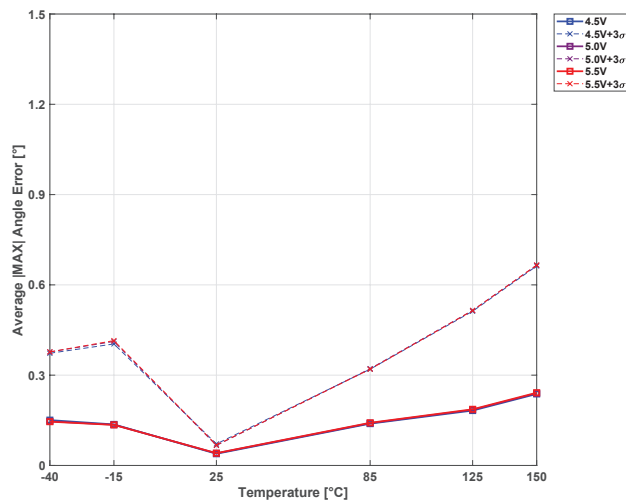

Figure 17: Average |Max| Dynamic Correction Angle Error +3σ over Temperature and V_{CC}

CHARACTERISTIC DEFINITIONS

Quiescent Voltage Output

In the quiescent state (no significant magnetic field: $B = 0$ G), the output, $V_{OUT(Q)}$, is at a constant ratio to the supply voltage, V_{CC} , across the entire operating ranges of V_{CC} and Operating Ambient Temperature, T_A . The ideal quiescent state output is $V_{CC} / 2$, so any deviations between $V_{OUT(Q)}$ and $V_{CC} / 2$ is QVO Error, $V_{ERR(OUT(Q))}$.

Equation 1:

$$V_{ERR(OUT(Q))} = (V_{OUT(Q)} - \frac{V_{CC}}{2})$$

QVO Temperature Drift

As operating temperature changes, $V_{OUT(Q)}$ will drift. $V_{OUT(Q)(TC)}$ is meant to describe this behavior relative to $V_{OUT(Q)}$ at 25°C expressed in Equation 2 as:

Equation 2:

$$V_{OUT(Q)(TC)} = \frac{V_{OUT(Q)(T_A)} - V_{OUT(Q)(25^\circ\text{C})}}{T_A - 25^\circ\text{C}}$$

Sensitivity

The amount of the output voltage change is proportional to the magnitude and polarity of the magnetic field applied. This proportionality is specified as the magnetic sensitivity, $Sens$ (mV/G), of the device and is defined in Equation 3:

Equation 3:

$$Sens = \frac{V_{OUT(B+)} - V_{OUT(B-)}}{(B+) - (B-)}$$

where $B+$ is the magnetic flux density in a positive field (south polarity) and $B-$ is the magnetic flux density in a negative field (north polarity). The sensitivity of the device will change with a change in V_{CC} , so use the equation in footnote 4 on page 4.

Sensitivity Temperature Drift

As operating temperature changes, the sensitivity of the device will change. $Sens_{TC}$ is meant to describe this behavior relative to $Sens$ at 25°C , expressed in Equation 4 as:

Equation 4:

$$Sens_{TC} = \frac{Sens_{(T_A)} - Sens_{25^\circ\text{C}}}{T_A - 25^\circ\text{C}}$$

Sensitivity Error

The A33230 is designed to provide linear outputs in response to a ramping applied magnetic field. Consider two magnetic fields, $B1$ and $B2$. Ideally, the sensitivity of a device is the same for both fields for a given supply voltage and temperature. Sensitivity error is present when there is a difference between the sensitivities measured at $B1$ and $B2$.

Sensitivity Error, $Sens_{ERR}$, is calculated separately for positive ($Sens_{ERR+}$) and negative ($Sens_{ERR-}$) applied magnetic fields. $Sens_{ERR}$ (%) is measured and defined as follows:

Equation 5:

$$Sens_{ERR+} = \left(1 - \frac{Sens_{(B2+)}}{Sens_{(B1+)}}\right) \times 100 (\%)$$

$$Sens_{ERR-} = \left(1 - \frac{Sens_{(B2-)}}{Sens_{(B1-)}}\right) \times 100 (\%)$$

where

Equation 6:

$$Sens_{Bx} = \frac{|V_{OUT(Bx)} - V_{OUT(Q)}|}{B_x}$$

Channel Linearity Error

Channel linearity error, ERR_{LIN} , quantifies the deviation of $OUTPUTA/B$ over an applied magnetic field relative to a perfect line. The ideal V_{OUT} of the device is comprised of the Applied Field (B_A) multiplied by the device's sensitivity ($Sens$) plus the device's Offset ($V_{OUT(Q)}$). This is expressed in Equation 7 as:

Equation 7:

$$ERR_{LIN} = \frac{V_{OUT(B_A)} - (B_A \times Sens + V_{OUT(Q)})}{|B_A \times Sens + V_{OUT(Q)}|} \times 100\%$$

The device will provide a linear output within specification for any $B_A \leq B_{MAX}$. For $B_A > B_{MAX}$, channel linearity performance will no longer be guaranteed.

Offset Ratiometry Error

Offset ratiometry error, $ERR_{RAT(QVO)}$, quantifies the non-linearity of $OUTPUTA/B$'s offset ($V_{OUT(Q)}$) over a changing supply voltage when there is 0 G of applied magnetic field. This is expressed in Equation 8 below. $V_{OUT(Q)}$ will change with a change in V_{CC} .

Equation 8:

$$ERR_{RAT(QVO)} = \left[\frac{(V_{OUT(Q)(V_{CC})} - V_{OUT(Q)(5V)})}{V_{OUT(Q)(5V)}} - \frac{(V_{CC} - V_{CC(5V)})}{V_{CC(5V)}} \right] \times 100\%$$

Sensitivity Ratiometry Error

Sensitivity ratiometry error, $ERR_{RAT(SENS)}$, quantifies the non-linearity of OUTPUTA/B's sensitivity over a changing supply voltage at a fixed magnetic field. This is expressed in Equation 9 below. Sens will change with a change in V_{CC} .

Equation 9:

$$ERR_{RAT(SENS)} = \left[\frac{(Sens_{(V_{CC})} - Sens_{(5V)})}{Sens_{(5V)}} - \frac{(V_{CC} - V_{CC(5V)})}{V_{CC(5V)}} \right] \times 100\%$$

Offset, Amplitude, Phase Correction, and Angle Derivation

The device provides sine and cosine signals whose argument is the local in-plane magnetic field angle. These signals are used downstream by the system for an angle derivation performed externally to the device. This section explains the typical angle derivation which includes offset, amplitude, and phase correction of the sinusoidal signals.

The two signals provided by the sensor are denoted x and y and can be modelled as follows:

$$\begin{cases} x(\theta) = A_c \cos(\theta + \varphi_c) + O_c \\ y(\theta) = A_s \sin(\theta + \varphi_s) + O_s \end{cases}$$

where A_c , A_s are the amplitude of the cosine and sine signals, O_c , O_s are the offset of the cosine and sine signals, and φ_c , φ_s are the phase of the cosine and sine signals, with respect to an arbitrary angle reference.

The above parameters are typically obtained in a calibration step or learned dynamically during the operation of the device by an external system. The parameters can be derived at different fields and or temperatures. Contact Allegro for further information on how to derive these parameters.

Once the above list of parameters is available, the offset, amplitude, and phase correction can be applied on every new (x,y) samples simultaneously acquired from the sensor. The correction must be performed as follow:

Offset removal and amplitude normalization:

$$x_{norm} = \frac{x(\theta) - O_c}{A_c}, \quad y_{norm} = \frac{y(\theta) - O_s}{A_s}$$

1. Impose quadrature between the two signals by phase-shifting one of the two signals:

$$x_{quad} = \tan(\varphi_c - \varphi_s) y_{norm} + \frac{1}{\cos(\varphi_c - \varphi_s)} x_{norm}$$

The pair of signals obtained can then be used to compute an angle value using an arctangent function. The resulting angle value includes a phase shift that must be removed:

$$\theta = \text{atan2D}(y_{norm}, x_{quad})$$

$$\theta = (\theta + \varphi_s) - \varphi_s$$

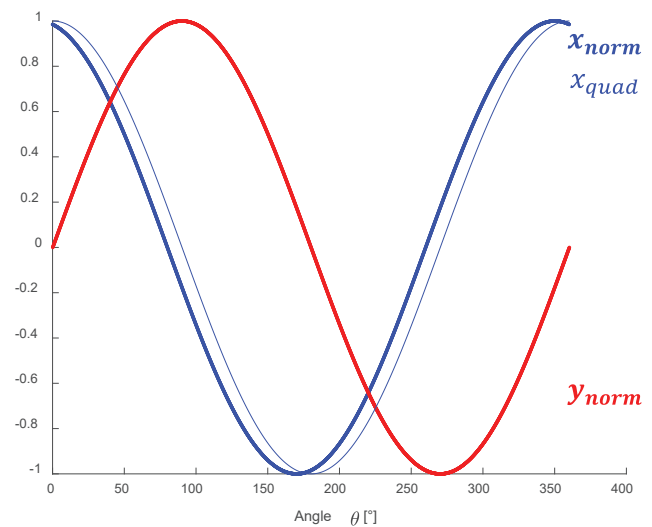

Calculating Native Angle Error

Native Angle Error is meant to reflect the A33230's true angle performance without any external signal corrections. An example of calculating the Native Angle Error of the A33230 relative to an arbitrary reference angle, θ_{REF} , can be seen as follows.

1. Angle is set to be θ_{REF} , resulting in:

$$\begin{cases} x(\theta_{REF}) = A_c \cos(\theta_{REF} + \varphi_c) + O_c \\ y(\theta_{REF}) = A_s \sin(\theta_{REF} + \varphi_s) + O_s \end{cases}$$

2. Before performing the $\text{atan2}(y,x)$ function, the x and y waveforms must be centered about 0. Subtracting the ideal $V_{OUT(Q)}$ value, $V_{CC} / 2$, from each output will accomplish this without removing each output's $V_{OUT(Q)}$ errors.

$$\begin{cases} x_{norm} = x(\theta_{REF}) - \frac{V_{CC}}{2} \\ y_{norm} = y(\theta_{REF}) - \frac{V_{CC}}{2} \end{cases}$$

- Now the atan2(y,x) function can be used to solve for an angle value.

$$\theta_{NAT} = \text{atan2}(y_{norm}, x_{norm})$$

- Finally, solve for the resulting Native Angle Error.

$$ERR_{ANG(NAT)\theta_{REF}} = \theta_{NAT} - \theta_{REF}$$

Calculating Angle Micro-Linearity Error

Angle Micro-Linearity Error, $ERR_{\mu LIN(\theta)}$, is used to reflect the gradient of Native Angle Error over any 1° increment. For a single 1° step, $ERR_{\mu LIN(\theta)}$ can be solved by taking the report angle value at $ANG_{(\theta+1^\circ)}$ and subtracting the angle value at $ANG_{(\theta)} + 1^\circ$. This is described in the following equation:

$$ERR_{\mu LIN(\theta)} = ANG_{(\theta_{REF}+1^\circ)} - (ANG_{(\theta_{REF})} + 1^\circ)$$

Conceptually, this is the same as taking the difference in Native Angle Error over any 1° increment.

Calculating One-Time Corrected Angle Error

To improve Angle Accuracy relative to Native Angle Error, a one-time correction can be applied to each A33230 output. An End-of-Line (EOL) calibration at 25°C is required in this case to solve for the parameters A_C , A_S , O_C , O_S , φ_C , and φ_S . Once these parameters are solved for, they can be used to compensate the A33230's real-time output in-application. The equations outlined in the Offset, Amplitude, Phase Correction, and Angle Derivation section describe the necessary steps to achieve a corrected angle value.

Calculating Dynamic Correction Angle Error

Offset, amplitude, and phase of the corrected sine and cosine waves will change with temperature, so using the compensation factors solved for at 25°C for all operating ranges will inject error into the system. To reduce Angle Error even further, an external system can apply an algorithm to dynamically adjust the offset (O_C , O_S) and amplitude (A_C , A_S) parameters in-application.

Once these parameters are solved for, they can be used to compensate the A33230's real-time output in-application. An example showing an external peak detector can be seen in the following section.

Recommended External Peak Detector for Dynamic Correction

Implementing a simple peak detector algorithm can provide users with a method to dynamically correct offset and amplitude over temperature. This peak-detector will monitor the maximum and minimum amplitudes of the corrected sine and cosine waveforms throughout operation. When a change in amplitude or offset occurs, it can be dynamically removed after a recommended rotation of 270°. A summary of this process is described below.

- 25°C calibration is performed to solve and compensate the native sine and cosine waveforms:

$$\text{Offset} \begin{cases} O_C = \frac{\max(x, 25^\circ C) + \min(x, 25^\circ C)}{2} \\ O_S = \frac{\max(y, 25^\circ C) + \min(y, 25^\circ C)}{2} \end{cases}$$

$$\text{Amplitude} \begin{cases} A_C = \frac{\max(x, 25^\circ C) - \min(x, 25^\circ C)}{2} \\ A_S = \frac{\max(y, 25^\circ C) - \min(y, 25^\circ C)}{2} \end{cases}$$

$$\text{Normalize} \begin{cases} x_{norm} = \frac{x - O_C}{A_C} \\ y_{norm} = \frac{y - O_S}{A_S} \end{cases}$$

$$\text{Impose Quad} \begin{cases} x_{quad} = \tan(\varphi_C - \varphi_S) y_{norm} + \frac{1}{\cos(\varphi_C - \varphi_S)} x_{norm} \end{cases}$$

$$\text{Solve Angle} \begin{cases} \theta - \varphi_S = \text{atan2D}(y_{norm}, x_{quad}) \\ \theta = (\theta - \varphi_S) - \varphi_S \end{cases}$$

- Track the maximum and minimum values of the corrected sine and cosine waveforms in operation. Once a recommended 270° of rotation has occurred, recalculate the offset and amplitude compensation factors.

$$\text{Offset} \begin{cases} O_C = \frac{\max(x_{quad}) + \min(x_{quad})}{2} \\ O_S = \frac{\max(y_{norm}) + \min(y_{norm})}{2} \end{cases}$$

$$\text{Amplitude} \begin{cases} A_C = \frac{\max(x_{quad}) - \min(x_{quad})}{2} \\ A_S = \frac{\max(y_{norm}) - \min(y_{norm})}{2} \end{cases}$$

$$\text{Normalize} \begin{cases} x_{norm} = \frac{x_{quad} - O_C}{A_C} \\ y_{norm} = \frac{y_{norm} - O_S}{A_S} \end{cases}$$

$$\text{Impose Quad} \begin{cases} x_{quad} = \tan(\varphi_C - \varphi_S) y_{norm} + \frac{1}{\cos(\varphi_C - \varphi_S)} x_{norm} \end{cases}$$

$$\text{Solve Angle} \begin{cases} \theta - \varphi_S = \text{atan2D}(y_{norm}, x_{quad}) \\ \theta = (\theta - \varphi_S) - \varphi_S \end{cases}$$

PACKAGE OUTLINE DRAWING

For Reference Only – Not for Tooling Use

(Reference Allegro DWG-0000628, Rev. 1)
 Dimensions in millimeters – NOT TO SCALE
 Dimensions exclusive of mold flash, gate burrs, and dambar protrusions
 Exact case and lead configuration at supplier discretion within limits shown

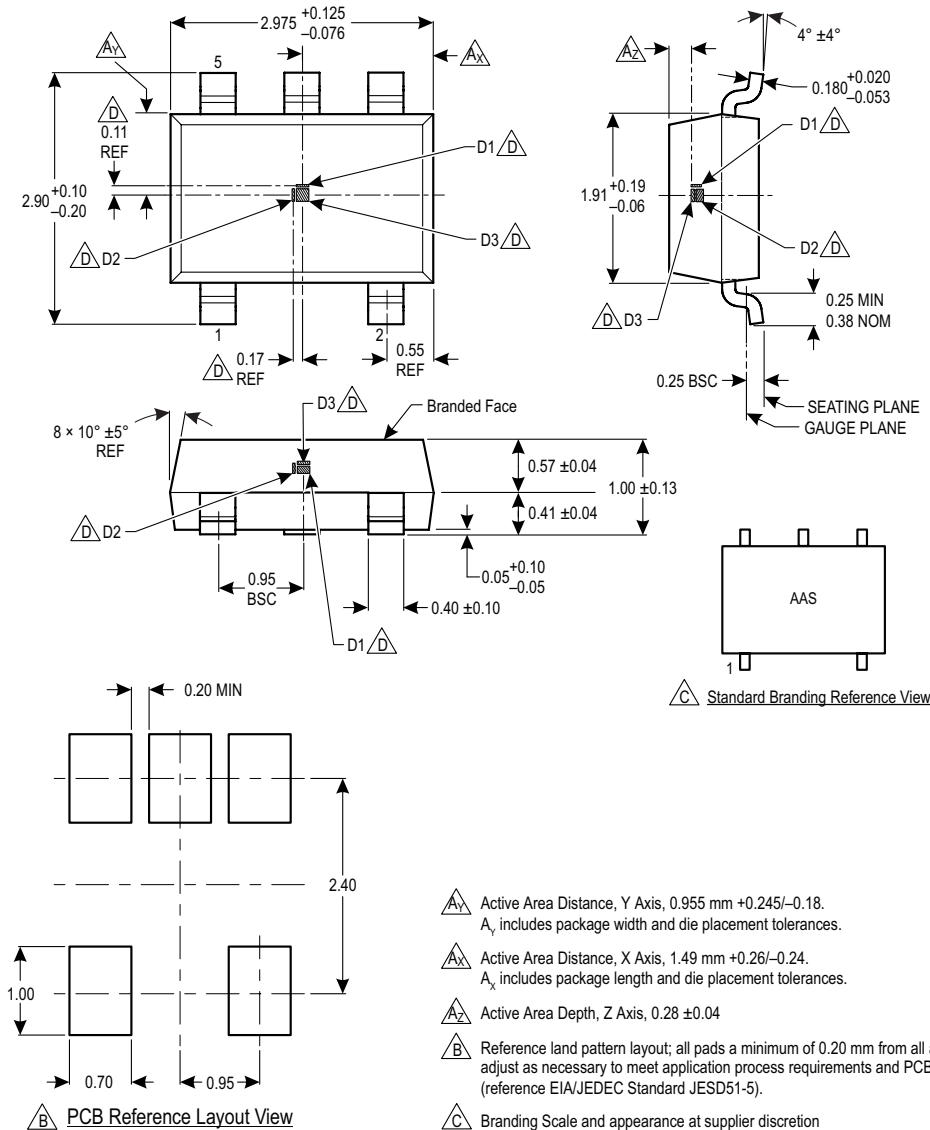

Figure 18: Package LH, 5-Pin SOT23-W

Revision History

Number	Date	Description
–	November 17, 2021	Initial release
1	December 1, 2021	Removed Orthogonality Error footnote and Sample Refresh Rate characteristic (page 4); removed Angle Micro-Linearity Error footnote, Footnote 2 (page 5); updated Native Angle Error, One Time External Correction, and Dynamic External Correction values (page 5); updated Figures 7-10 (page 7); updated Calculating Angle Micro-Linearity Error section (page 13); updated package drawing notes A _X and A _Y (page 14).
2	January 17, 2022	Updated Features and Benefits (page 1) and “Delay Time” to “Response Time” (page 4); corrected Native Angle Error, One Time External Correction, and Dynamic External Correction values (page 5)
3	February 28, 2024	Updated equations (page 13) and package branding (page 14)

Copyright 2024, Allegro MicroSystems.

Allegro MicroSystems reserves the right to make, from time to time, such departures from the detail specifications as may be required to permit improvements in the performance, reliability, or manufacturability of its products. Before placing an order, the user is cautioned to verify that the information being relied upon is current.

Allegro’s products are not to be used in any devices or systems, including but not limited to life support devices or systems, in which a failure of Allegro’s product can reasonably be expected to cause bodily harm.

The information included herein is believed to be accurate and reliable. However, Allegro MicroSystems assumes no responsibility for its use; nor for any infringement of patents or other rights of third parties which may result from its use.

Copies of this document are considered uncontrolled documents.

For the latest version of this document, visit our website:

www.allegromicro.com

X-ON Electronics

Largest Supplier of Electrical and Electronic Components

Click to view similar products for [Board Mount Hall Effect/Magnetic Sensors](#) category:

Click to view products by [Allegro](#) manufacturer:

Other Similar products are found below :

[HGPRDT005A](#) [AH1894-FA-7](#) [AH277AZ4-AG1](#) [AV-10448](#) [SS41C](#) [AH1894-Z-7](#) [TLE4946-1L](#) [TLE4976L](#) [SS85CA](#) [BU52003GUL-E2](#)
[AH277AZ4-BG1](#) [AH3376-P-B](#) [TLE4941](#) [TLE4945-2L](#) [AH3360-FT4-7](#) [TLE4941-1](#) [AH374-P-A](#) [SS41-JL](#) [AH1913-W-7](#) [AH3373-P-B](#)
[MA732GQ-Z](#) [MA330GQ-Z](#) [S-57K1NBL2A-M3T2U](#) [S-57P1NBL9S-M3T4U](#) [S-576ZNL2B-L3T2U](#) [S-576ZNL2B-A6T8U](#) [S-57P1NBL0S-](#)
[M3T4U](#) [S-57A1NSL1A-M3T2U](#) [S-57K1RBL1A-M3T2U](#) [S-57P1NBH9S-M3T4U](#) [S-57P1NBH0S-M3T4U](#) [S-57A1NSH1A-M3T2U](#) [S-](#)
[57A1NSH2A-M3T2U](#) [S-57K1NBH1A-M3T2U](#) [S-57A1NNL1A-M3T2U](#) [S-5701BC11B-L3T2U5](#) [S-57GNNL3S-A6T8U](#) [S-57TZ1L1S-](#)
[A6T8U](#) [S-57GSNL3S-A6T8U](#) [S-5716ANDH0-I4T1U](#) [S-57GSNL5S-L3T2U](#) [S-57GDNL3S-L3T2U](#) [S-57GNNL3S-L3T2U](#) [S-57RBNL8S-](#)
[L3T2U](#) [S-57RBNL9S-A6T8U](#) [S-57RB1L8S-L3T2U](#) [S-57GDNL5S-L3T2U](#) [S-57RBNL9S-L3T2U](#) [S-57TZ1L1S-L3T2U](#) [S-57TZNL1S-](#)
[A6T8U](#)