

1 MHz Bandwidth, Galvanically Isolated Current Sensor IC in SOIC-16 Package

FEATURES AND BENEFITS

- AEC-Q100 automotive qualified
- High bandwidth, 1 MHz analog output
- Differential Hall sensing rejects common-mode fields
- High-isolation SOIC16 wide body package provides galvanic isolation for high-voltage applications
- Integrated shield virtually eliminates capacitive coupling from current conductor to die, greatly suppressing output noise due to high dv/dt transients
- Industry-leading noise performance with greatly improved bandwidth through proprietary amplifier and filter design
- UL60950-1 (ed. 2) certified
 - Dielectric Strength Voltage = 3.6 kV_{RMS}
 - Basic Isolation Working Voltage = 616 V_{RMS}
- Fast and externally configurable overcurrent fault detection
- 1 mΩ primary conductor resistance for low power loss and high inrush current withstand capability
- Options for 3.3 V and 5 V single supply operation
- Output voltage proportional to AC and DC current
- Factory-trimmed sensitivity and quiescent output voltage for improved accuracy
- Nearly zero magnetic hysteresis
- Ratiometric output from supply voltage

PACKAGE: 16-Pin SOICW (suffix LA)

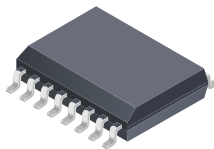

Not to scale



DESCRIPTION

The ACS732 and ACS733 are a new generation of high bandwidth current sensor ICs from Allegro™. These devices provide a compact, fast, and accurate solution for measuring high-frequency currents in DC/DC converters and other switching power applications. The ACS732 and ACS733 offer high isolation, high bandwidth Hall-effect-based current sensing with user-configurable overcurrent fault detection. These features make them ideally suited for high-frequency transformer and current transformer replacement in applications running at high voltages.

The ACS732 and ACS733 are suitable for all markets, including automotive, industrial, commercial, and communications systems. They may be used in motor control, load detection and management, switch-mode power supplies, and overcurrent fault protection applications.

The wide body SOIC-16 package allows for easy implementation. Applied current flowing through the copper conduction path generates a magnetic field that is sensed by the IC and converted to a proportional voltage. Current is sensed differentially in order to reject external common-mode fields. Device accuracy is optimized through the close proximity of the magnetic field to the Hall transducers. A precise, proportional voltage is provided by the Hall IC, which is factory-programmed after packaging for high accuracy. The fully integrated package has an internal copper conductive path with a typical resistance of 1 mΩ, providing low power loss.

The current-carrying pins (pins 1 through 8) are electrically isolated from the sensor leads (pins 9 through 16). This allows the devices to be used in high-side current sensing applications without the use of high-side differential amplifiers or other costly isolation techniques.

Continued on next page...

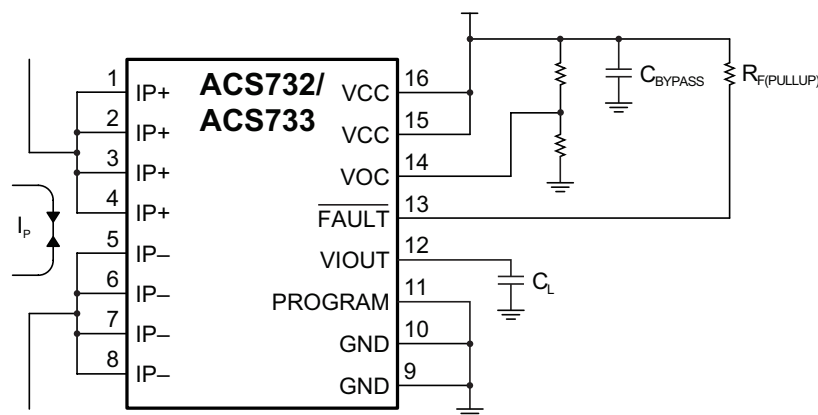

ACS732/ACS733 outputs an analog signal, V_{IOUT} , that changes proportionally with the bidirectional AC or DC primary sensed current, I_p , within the specified measurement range.

The overcurrent threshold may be set with a resistor divider tied to the V_{OC} pin.

Figure 1: Typical Application Circuit

ACS732 and ACS733

1 MHz Bandwidth, Galvanically Isolated Current Sensor IC in SOIC-16 Package

DESCRIPTION (continued)

The ACS732 and ACS733 are provided in a small, low profile, surface-mount SOIC-16 wide-body package. The leadframe is plated with 100% matte tin, which is compatible with standard lead (Pb)

free printed circuit board assembly processes. Internally, the device is lead-free. These devices are fully calibrated prior to shipment from the Allegro factory.

SELECTION GUIDE

Part Number	Optimized Range, I_P (A)	Sensitivity [1], Sens(Typ) (mV/A)	Nominal Supply Voltage, V_{CC} , (V)	T_A (°C)	Packing [2]
ACS732KLATR-20AB-T	±20	100	5.0	-40 to 125	Tape and reel, 1000 pieces per reel
ACS732KLATR-40AB-T	±40	50			
ACS732KLATR-65AB-T	±65	30			
ACS732KLATR-65AU-T	65	60			
ACS732KLATR-75AB-T	±75	26.6			
ACS733KLATR-20AB-T	±20	66	3.3		
ACS733KLATR-20AB-T-H [3]	±20	66			
ACS733KLATR-40AB-T	±40	33			
ACS733KLATR-40AU-T	40	66			
ACS733KLATR-65AB-T	±65	20			

[1] Measured at Nominal Supply Voltage, V_{CC} .

[2] Contact Allegro for additional packing options.

[3] -H denotes 100% cold calibration at the Allegro factory for improved accuracy.



ACS732 and ACS733

1 MHz Bandwidth, Galvanically Isolated Current Sensor IC in SOIC-16 Package

ABSOLUTE MAXIMUM RATINGS

Characteristic	Symbol	Notes	Rating	Units
Supply Voltage	V_{CC}		6	V
Reverse Supply Voltage	V_{RCC}		-0.1	V
Output Voltage	V_{IOUT}		6	V
Reverse Output Voltage	V_{RIOUT}		-0.1	V
Fault Output Voltage	V_{FAULT}		6	V
Reverse Fault Output Voltage	V_{RFAULT}		-0.1	V
Forward V_{OC} Voltage	V_{VOC}		6	V
Reverse V_{OC} Voltage	V_{VOC}		-0.1	V
Output Current	I_{OUT}	Maximum survivable sink or source current on the output	15	mA
Maximum Continuous Current	I_{CMAX}	$T_A = 25^\circ\text{C}$	55	A
Nominal Operating Ambient Temperature	T_A	Range K	-40 to 125	$^\circ\text{C}$
Maximum Junction Temperature	$T_J(\text{max})$		165	$^\circ\text{C}$
Storage Temperature	T_{stg}		-65 to 170	$^\circ\text{C}$

ESD RATINGS

Characteristic	Symbol	Test Conditions	Value	Unit
Human Body Model	V_{HBM}	Per AEC-Q100	± 12	kV
Charged Device Model	V_{CDM}	Per AEC-Q100	± 1	kV

ISOLATION CHARACTERISTICS

Characteristic	Symbol	Notes	Value	Units
Dielectric Surge Strength Test Voltage	V_{SURGE}	Tested ± 5 pulses at 2/minute in compliance to IEC 61000-4-5 1.2 μs (rise) / 50 μs (width).	10000	V
Dielectric Strength Test Voltage	V_{ISO}	Agency type-tested for 60 seconds per UL 60950-1 (edition 2). Production Tested at 2250 V_{RMS} per UL 60950-1.	3600	V_{RMS}
Working Voltage for Basic Isolation	V_{WVBI}	Maximum approved working voltage for basic (single) isolation according to UL 60950-1 (edition 2).	870	V_{PK} OR V_{DC}
			616	V_{RMS}
Clearance	D_{CL}	Minimum distance through air from IP leads to signal leads.	7.5	mm
Creepage	D_{CR}	Minimum distance along package body from IP leads to signal leads.	7.5	mm
Distance Through Insulation	DTI	Minimum internal distance through insulation	38	μm
Comparative Tracking Index	CTI	Material Group II	400 to 599	V

THERMAL CHARACTERISTICS [1]

Characteristic	Symbol	Test Conditions	Value	Unit
Junction-to-Ambient Thermal Resistance	$R_{\theta JA}$	Mounted on the Allegro ASEK732/3 evaluation board. Performance values include the power consumed by the PCB. [2]	17	$^\circ\text{C/W}$
Junction-to-Lead Thermal Resistance	$R_{\theta JL}$	Mounted on the Allegro ASEK732/3 evaluation board. [2]	5	$^\circ\text{C/W}$

[1] Refer to the die temperature curves versus DC current plot (p. 29). Additional thermal information is available on the Allegro website.

[2] The Allegro evaluation board has 1500 mm² of 2 oz. copper on each side, connected to pins 1 through 4 and pins 5 through 8, with thermal vias connecting the layers. Performance values include the power consumed by the PCB. Further details on the board are available from the Frequently Asked Questions document on our website. Further information about board design and thermal performance also can be found in the Applications Information section of this datasheet.

PINOUT DIAGRAM AND TERMINAL LIST TABLE

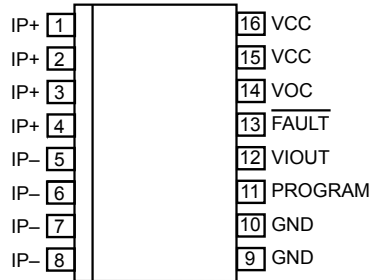

**Package LA, 16-Pin
SOICW Pinout Diagram**

Terminal List Table

Number	Name	Description
1,2,3,4	IP+	Positive terminals for current being sensed; fused internally.
5,6,7,8	IP-	Negative terminals for current being sensed; fused internally.
9,10	GND	Device ground terminal.
11	PROGRAM	Programming input pin for factory calibration. Connect to ground for best ESD performance.
12	VIOUT	Analog output signal.
13	FAULT	Overcurrent Fault output. Open drain.
14	VOC	Set the overcurrent fault threshold via external resistor divider on this pin.
15,16	VCC	Device power supply terminal.

FUNCTIONAL BLOCK DIAGRAM

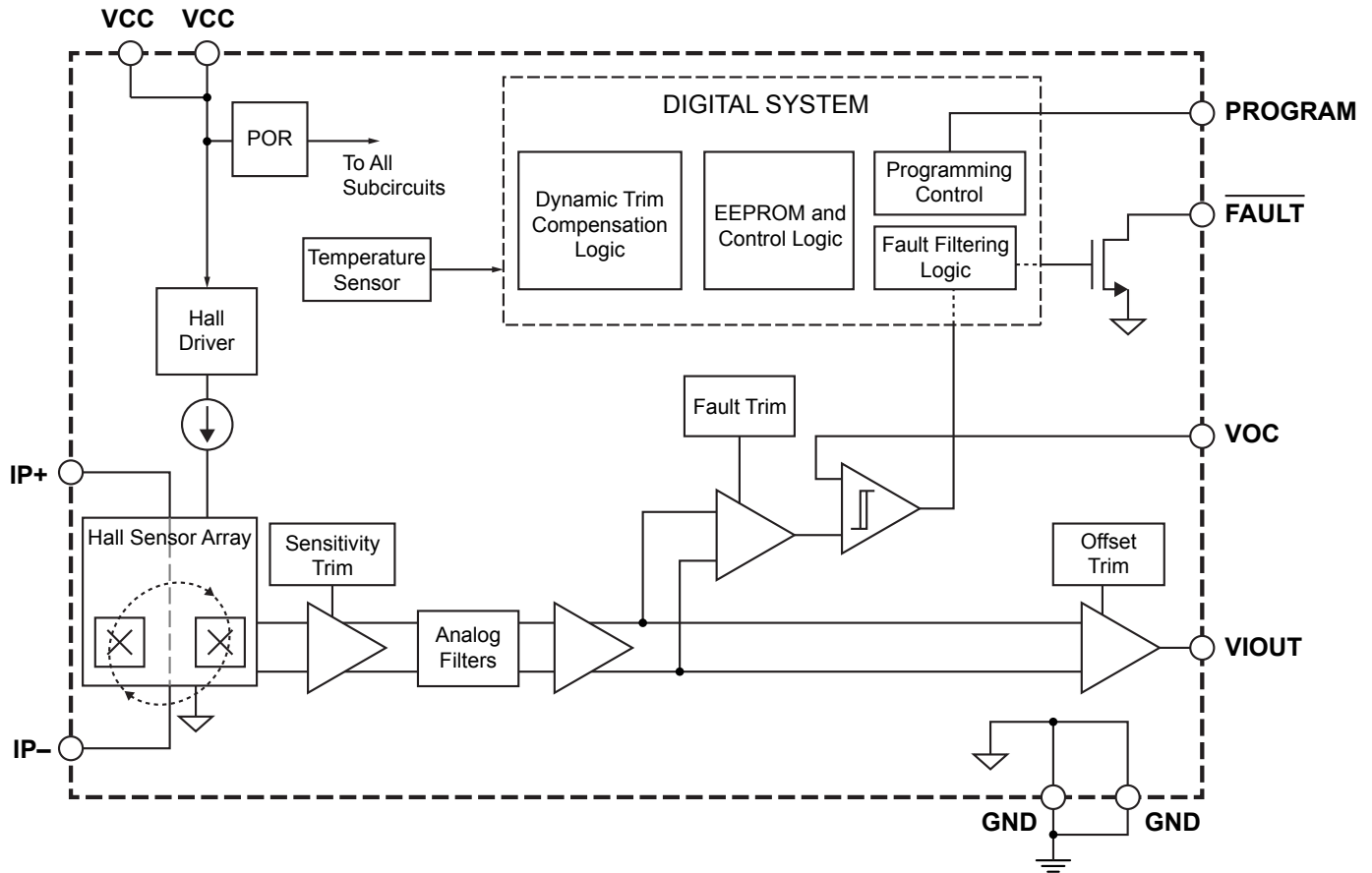

Figure 2: Functional Block Diagram

ACS732 and ACS733

1 MHz Bandwidth, Galvanically Isolated Current Sensor IC in SOIC-16 Package

COMMON ELECTRICAL CHARACTERISTICS: Over full range of T_A , over supply voltage range $V_{CC(MIN)}$ through $V_{CC(MAX)}$ of a sensor variant, $C_{BYPASS} = 0.1 \mu F$, unless otherwise specified

Characteristic	Symbol	Test Conditions	Min.	Typ. [1]	Max.	Unit
Supply Voltage	V_{CC}	ACS732	4.75	5.0	5.25	V
		ACS733	3.14	3.3	3.46	V
Supply Current	I_{CC}	ACS732; $V_{CC} = 5.0 V$	–	24	35	mA
		ACS733; $V_{CC} = 3.3 V$	–	20	35	mA
Bypass Capacitor [2]	C_{BYPASS}	V_{CC} to GND	0.1	–	–	μF
Output Capacitance Load	C_L	V_{IOUT} to GND	–	–	220	pF
Output Resistive Load	R_L	V_{IOUT} to GND	50	–	–	k Ω
Output Saturation Voltage	$V_{SAT(HIGH)}$	$V_{CC} = 5.0 V, T_A = 25^\circ C,$ $R_{L(PULLDOWN)} = 50 k\Omega$ to GND	$V_{CC} - 0.3$	–	–	V
		$V_{CC} = 3.3 V, T_A = 25^\circ C,$ $R_{L(PULLDOWN)} = 50 k\Omega$ to GND	$V_{CC} - 0.3$	–	–	V
	$V_{SAT(LOW)}$	$V_{CC} = 5.0 V, T_A = 25^\circ C,$ $R_{L(PULLDOWN)} = 50 k\Omega$ to VCC	–	–	0.3	V
		$V_{CC} = 3.3 V, T_A = 25^\circ C,$ $R_{L(PULLDOWN)} = 50 k\Omega$ to VCC	–	–	0.2	V
Primary Conductor Resistance	R_{IP}	$T_A = 25^\circ C$	–	1	–	m Ω
Primary Hall Coupling Factor	$C_{F(P)}$	$T_A = 25^\circ C$	–	10.8	–	G/A
Secondary Hall Coupling Factor	$C_{F(S)}$	$T_A = 25^\circ C$	–	2.4	–	G/A
Hall Plate Sensitivity Matching	$Sens_{match}$	$T_A = 25^\circ C$	–	1	–	%
Power On Delay Time	t_{POD}	$T_A = 25^\circ C$	–	180	–	μs
Internal Bandwidth	BW	Small signal –3 dB; $C_L = 220 pF$	–	1	–	MHz
Rise Time [3]	t_r	$T_A = 25^\circ C, C_L = 0.22 nF$	–	0.7	–	μs
Response Time [3]	$t_{RESPONSE}$	$T_A = 25^\circ C, C_L = 0.22 nF$	–	0.2	–	μs
Propagation Delay Time [3]	t_{pd}	$T_A = 25^\circ C, C_L = 0.22 nF$	–	0.14	–	μs
Output Slew Rate	SR	$T_A = 25^\circ C, C_L = 0.22 nF$	–	3.2	–	V/ μs
Zero Current Output Ratiometry Error	$E_{RAT(Q)}$	$T_A = 25^\circ C, V_{CC} = \pm 5\%$ variation of nominal supply voltage	–12	± 10	12	mV
Sensitivity Ratiometry Error	$E_{RAT(SENS)}$	$T_A = 25^\circ C, V_{CC} = \pm 5\%$ variation of nominal supply voltage	–2	± 1.72	2	%
Ratiometry Bandwidth	BW_{RAT}	$\pm 100 mV$ on V_{CC}	–	10	–	kHz
Noise Density	I_{ND}	$V_{CC} = 5.0 V, T_A = 25^\circ C, C_L = 220 pF;$ input referred	–	55	–	$\mu A/\sqrt{Hz}$
		$V_{CC} = 3.3 V, T_A = 25^\circ C, C_L = 220 pF;$ input referred	–	80	–	$\mu A/\sqrt{Hz}$

Continued on next page...

COMMON ELECTRICAL CHARACTERISTICS (continued): Over full range of T_A , over supply voltage range $V_{CC(MIN)}$ through $V_{CC(MAX)}$ of a sensor variant, $C_{BYPASS} = 0.1 \mu F$, unless otherwise specified

Characteristic	Symbol	Test Conditions	Min.	Typ. [1]	Max.	Unit
OVERCURRENT FAULT CHARACTERISTICS						
\overline{FAULT} Response Time [4]	$t_{RESPONSE(F)}$	Time from $I_P > I_{FAULT}$ to when \overline{FAULT} pin is pulled below $V_{\overline{FAULT}}$; input current step from 0 to $1.2 \times I_{FAULT}$	0.2	0.5	0.75	μs
\overline{FAULT} Release Time [4]	$t_{C(F)}$	Time from I_P falling below $I_{FAULT} - I_{HYS}$ to when $V_{\overline{FAULT}}$ is pulled above $V_{\overline{FAULTL}}$; 100 pF from \overline{FAULT} to ground	0.1	–	0.45	μs
\overline{FAULT} Range	$I_{\overline{FAULT}}$	Relative to the full scale of I_{PR} ; set via the VOC pin	$0.5 \times I_{PR}$	–	$2 \times I_{PR}$	A
\overline{FAULT} Output Low Voltage	$V_{\overline{FAULT}}$	In fault condition; $R_{F(PULLUP)} = 10 k\Omega$	–	–	0.4	V
\overline{FAULT} Pull-Up Resistance	$R_{F(PULLUP)}$		10	–	500	k Ω
\overline{FAULT} Leakage Current	$I_{\overline{FAULT}(LEAKAGE)}$		–	± 2	–	nA
\overline{FAULT} Hysteresis [5]	I_{HYS}		–	$0.05 \times I_{PR}$	–	A
\overline{FAULT} Error [6]	$E_{\overline{FAULT}}$	Tested at $V_{VOC} = 0.2 \times V_{CC}$ ($I_{\overline{FAULT}}$ threshold = $100\% \times I_{PR}$)	–	± 5	–	%
V_{OC} Input Range	V_{VOC}		$0.1 \times V_{CC}$	–	$0.4 \times V_{CC}$	V
V_{OC} Input Current	I_{VOC}		–	10	100	nA

[1] Typical values are mean ± 3 sigma values.

[2] Use of a bypass capacitor is required to increase output stability.

[3] See definitions of Dynamic Response Characteristics section of this datasheet.

[4] Guaranteed by design.

[5] After I_P goes above $I_{\overline{FAULT}}$, tripping the internal comparator, I_P must fall below $I_{\overline{FAULT}} - I_{HYS}$, before the internal comparator will reset.

[6] Fault error is defined as the value at which a fault is reported relative to the desired threshold for $I_{\overline{FAULT}}$.

ACS732 and ACS733

1 MHz Bandwidth, Galvanically Isolated Current Sensor IC in SOIC-16 Package

ACS732KLATR-20AB PERFORMANCE CHARACTERISTICS: Valid at $T_A = -40^\circ\text{C}$ to 125°C , $V_{CC} = 5\text{ V}$, $C_{BYPASS} = 0.1\ \mu\text{F}$, unless otherwise specified

Characteristic	Symbol	Test Conditions	Min.	Typ. [1]	Max.	Unit
NOMINAL PERFORMANCE						
Current Sensing Range	I_{PR}		-20	-	20	A
Sensitivity	Sens		-	100	-	mV/A
Zero Current Output Voltage	$V_{IOUT(Q)}$	Bidirectional, $I_P = 0\text{ A}$	-	$0.5 \times V_{CC}$	-	V
TOTAL OUTPUT ERROR COMPONENTS [2] $E_{TOT} = E_{SENS} + 100 \times V_{OE} / (\text{Sens} \times I_P)$						
Total Output Error [3]	E_{TOT}	$I_P = I_{PR(max)}$, $T_A = 25^\circ\text{C}$	-2.5	± 1.6	2.5	%
		$I_P = I_{PR(max)}$, $T_A = 125^\circ\text{C}$	-3	± 2	3	%
		$I_P = I_{PR(max)}$, $T_A = 25^\circ\text{C}$ to 125°C	-	± 2.6	-	%
		$I_P = I_{PR(max)}$, $T_A = -40^\circ\text{C}$	-7.5	± 4.5	7.5	%
Sensitivity Error	E_{SENS}	$I_P = I_{PR(max)} / 2$, $T_A = 25^\circ\text{C}$	-1.5	± 0.75	1.5	%
		$I_P = I_{PR(max)} / 2$, $T_A = 125^\circ\text{C}$	-1.5	± 1.25	1.5	%
		$I_P = I_{PR(max)} / 2$, $T_A = -40^\circ\text{C}$	-3	± 2	3	%
Voltage Offset Error	V_{OE}	$I_P = 0\text{ A}$, $T_A = 25^\circ\text{C}$	-55	± 30	55	mV
		$I_P = 0\text{ A}$, $T_A = 125^\circ\text{C}$	-25	± 18	25	mV
		$I_P = 0\text{ A}$, $T_A = 25^\circ\text{C}$ to 125°C	-	± 50	-	mV
		$I_P = 0\text{ A}$, $T_A = -40^\circ\text{C}$	-120	± 100	120	mV
Linearity Error [4]	E_{LIN}	$T_A = 25^\circ\text{C}$, up to full-scale I_P	-1	± 0.2	1	%
		$T_A = 125^\circ\text{C}$, up to full-scale I_P	-	± 0.3	-	%
		$T_A = -40^\circ\text{C}$, up to full-scale I_P	-	± 0.5	-	%
LIFETIME DRIFT CHARACTERISTICS [5]						
Total Output Error Including Lifetime Drift	$E_{TOT(DRIFT)}$	$I_P = I_{PR(max)}$, $T_A = 25^\circ\text{C}$, 125°C	-	± 11.5	-	%
		$I_P = I_{PR(max)}$, $T_A = -40^\circ\text{C}$, 25°C	-	± 11.5	-	%
Sensitivity Error Including Lifetime Drift	$E_{SENS(DRIFT)}$	$I_P = I_{PR(max)} / 2$, $T_A = 25^\circ\text{C}$, 125°C	-	± 2.2	-	%
		$I_P = I_{PR(max)} / 2$, $T_A = -40^\circ\text{C}$, 25°C	-	± 3.3	-	%
Offset Voltage Error Including Lifetime Drift	$V_{OE(DRIFT)}$	$T_A = 25^\circ\text{C}$, 125°C	-	± 220	-	mV
		$T_A = -40^\circ\text{C}$, 25°C	-	± 220	-	mV

[1] Typical values with \pm are mean ± 3 sigma values, except for lifetime drift which are the average value including drift after AEC-Q100 qualification.

[2] A single part will not have both the maximum sensitivity error and the maximum offset voltage, as that would violate the maximum/minimum total output error specification. For total error, 3 sigma distribution values for offset and sensitivity may be combined by taking the square root of the sum of the squares. See characteristic performance data plots for temperature drift performance.

[3] Percentage of I_P , with $I_P = I_{PR(MAX)}$.

[4] The sensor will continue to respond to current beyond the range of I_{PR} until the high or low output saturation voltage. However, the nonlinearity in this region may be worse than the nominal operating range.

[5] Lifetime drift characteristics are based on AEC-Q100 qualification results. Typical values are mean ± 3 sigma of worst case stress testing. Drift is a function of customer application conditions. Contact Allegro MicroSystems for further information.

ACS732 and ACS733

1 MHz Bandwidth, Galvanically Isolated Current Sensor IC in SOIC-16 Package

ACS732KLATR-40AB PERFORMANCE CHARACTERISTICS: Valid at $T_A = -40^\circ\text{C}$ to 125°C , $V_{CC} = 5\text{ V}$, $C_{BYPASS} = 0.1\ \mu\text{F}$, unless otherwise specified

Characteristic	Symbol	Test Conditions	Min.	Typ. [1]	Max.	Unit
NOMINAL PERFORMANCE						
Current Sensing Range	I_{PR}		-40	-	40	A
Sensitivity	Sens		-	50	-	mV/A
Zero Current Output Voltage	$V_{IOUT(Q)}$	Bidirectional, $I_P = 0\text{ A}$	-	$0.5 \times V_{CC}$	-	V
TOTAL OUTPUT ERROR COMPONENTS [2] $E_{TOT} = E_{SENS} + 100 \times V_{OE} / (\text{Sens} \times I_P)$						
Total Output Error [3]	E_{TOT}	$I_P = I_{PR(max)}$, $T_A = 25^\circ\text{C}$	-2.5	± 2	2.5	%
		$I_P = I_{PR(max)}$, $T_A = 125^\circ\text{C}$	-2.5	± 1.6	2.5	%
		$I_P = I_{PR(max)}$, $T_A = 25^\circ\text{C}$ to 125°C	-	± 2.6	-	%
		$I_P = I_{PR(max)}$, $T_A = -40^\circ\text{C}$	-6.5	± 4.5	6.5	%
Sensitivity Error	E_{SENS}	$I_P = I_{PR(max)} / 2$, $T_A = 25^\circ\text{C}$	-2	± 0.8	2	%
		$I_P = I_{PR(max)} / 2$, $T_A = 125^\circ\text{C}$	-2	± 1.2	2	%
		$I_P = I_{PR(max)} / 2$, $T_A = -40^\circ\text{C}$	-4	± 1.8	4	%
Voltage Offset Error	V_{OE}	$I_P = 0\text{ A}$, $T_A = 25^\circ\text{C}$	-45	± 40	45	mV
		$I_P = 0\text{ A}$, $T_A = 125^\circ\text{C}$	-25	± 20	25	mV
		$I_P = 0\text{ A}$, $T_A = 25^\circ\text{C}$ to 125°C	-	± 45	-	mV
		$I_P = 0\text{ A}$, $T_A = -40^\circ\text{C}$	-95	± 90	95	mV
Linearity Error [4]	E_{LIN}	$T_A = 25^\circ\text{C}$, up to full-scale I_P	-1.2	± 0.8	1.2	%
		$T_A = 125^\circ\text{C}$, up to full-scale I_P	-	± 0.33	-	%
		$T_A = -40^\circ\text{C}$, up to full-scale I_P	-	± 2.5	-	%
LIFETIME DRIFT CHARACTERISTICS [5]						
Total Output Error Including Lifetime Drift	$E_{TOT(DRIFT)}$	$I_P = I_{PR(max)}$, $T_A = 25^\circ\text{C}$, 125°C	-	± 6.3	-	%
		$I_P = I_{PR(max)}$, $T_A = -40^\circ\text{C}$, 25°C	-	± 6.3	-	%
Sensitivity Error Including Lifetime Drift	$E_{SENS(DRIFT)}$	$I_P = I_{PR(max)} / 2$, $T_A = 25^\circ\text{C}$, 125°C	-	± 2.2	-	%
		$I_P = I_{PR(max)} / 2$, $T_A = -40^\circ\text{C}$, 25°C	-	± 3.3	-	%
Offset Voltage Error Including Lifetime Drift	$V_{OE(DRIFT)}$	$T_A = 25^\circ\text{C}$, 125°C	-	± 110	-	mV
		$T_A = -40^\circ\text{C}$, 25°C	-	± 110	-	mV

[1] Typical values with \pm are mean ± 3 sigma values, except for lifetime drift which are the average value including drift after AEC-Q100 qualification.

[2] A single part will not have both the maximum sensitivity error and the maximum offset voltage, as that would violate the maximum/minimum total output error specification. For total error, 3 sigma distribution values for offset and sensitivity may be combined by taking the square root of the sum of the squares. See characteristic performance data plots for temperature drift performance.

[3] Percentage of I_P , with $I_P = I_{PR(MAX)}$.

[4] The sensor will continue to respond to current beyond the range of I_{PR} until the high or low output saturation voltage. However, the nonlinearity in this region may be worse than the nominal operating range.

[5] Lifetime drift characteristics are based on AEC-Q100 qualification results. Typical values are mean ± 3 sigma of worst case stress testing. Drift is a function of customer application conditions. Contact Allegro MicroSystems for further information.

ACS732 and ACS733

1 MHz Bandwidth, Galvanically Isolated Current Sensor IC in SOIC-16 Package

ACS732KLATR-65AB PERFORMANCE CHARACTERISTICS: Valid at $T_A = -40^\circ\text{C}$ to 125°C , $V_{CC} = 5\text{ V}$, $C_{BYPASS} = 0.1\ \mu\text{F}$, unless otherwise specified

Characteristic	Symbol	Test Conditions	Min.	Typ. [1]	Max.	Unit
NOMINAL PERFORMANCE						
Current Sensing Range	I_{PR}		-65	-	65	A
Sensitivity	Sens		-	30	-	mV/A
Zero Current Output Voltage	$V_{IOUT(Q)}$	Bidirectional, $I_P = 0\text{ A}$	-	$0.5 \times V_{CC}$	-	V
TOTAL OUTPUT ERROR COMPONENTS [2] $E_{TOT} = E_{SENS} + 100 \times V_{OE} / (\text{Sens} \times I_P)$						
Total Output Error [3]	E_{TOT}	$I_P = I_{PR(max)}$, $T_A = 25^\circ\text{C}$	-2.5	± 1.6	2.5	%
		$I_P = I_{PR(max)}$, $T_A = 125^\circ\text{C}$	-2.5	± 1	2.5	%
		$I_P = I_{PR(max)}$, $T_A = 25^\circ\text{C}$ to 125°C	-	± 2.6	-	%
		$I_P = I_{PR(max)}$, $T_A = -40^\circ\text{C}$	-6.5	± 3.4	6.5	%
Sensitivity Error	E_{SENS}	$I_P = I_{PR(max)} / 2$, $T_A = 25^\circ\text{C}$	-2	± 1.5	2	%
		$I_P = I_{PR(max)} / 2$, $T_A = 125^\circ\text{C}$	-2	± 0.9	2	%
		$I_P = I_{PR(max)} / 2$, $T_A = -40^\circ\text{C}$	-4	± 2.7	4	%
Voltage Offset Error	V_{OE}	$I_P = 0\text{ A}$, $T_A = 25^\circ\text{C}$	-45	± 27	45	mV
		$I_P = 0\text{ A}$, $T_A = 125^\circ\text{C}$	-25	± 8	25	mV
		$I_P = 0\text{ A}$, $T_A = 25^\circ\text{C}$ to 125°C	-	± 45	-	mV
		$I_P = 0\text{ A}$, $T_A = -40^\circ\text{C}$	-95	± 58	95	mV
Linearity Error [4]	E_{LIN}	$T_A = 25^\circ\text{C}$, up to full-scale I_P	-2.4	± 1.7	2.4	%
		$T_A = 125^\circ\text{C}$, up to full-scale I_P	-	± 0.6	-	%
		$T_A = -40^\circ\text{C}$, up to full-scale I_P	-	± 5.8	-	%
LIFETIME DRIFT CHARACTERISTICS [5]						
Total Output Error Including Lifetime Drift	$E_{TOT(DRIFT)}$	$I_P = I_{PR(max)}$, $T_A = 25^\circ\text{C}$, 125°C	-	± 4.7	-	%
		$I_P = I_{PR(max)}$, $T_A = -40^\circ\text{C}$, 25°C	-	± 4.7	-	%
Sensitivity Error Including Lifetime Drift	$E_{SENS(DRIFT)}$	$I_P = I_{PR(max)} / 2$, $T_A = 25^\circ\text{C}$, 125°C	-	± 2.2	-	%
		$I_P = I_{PR(max)} / 2$, $T_A = -40^\circ\text{C}$, 25°C	-	± 3.3	-	%
Offset Voltage Error Including Lifetime Drift	$V_{OE(DRIFT)}$	$T_A = 25^\circ\text{C}$, 125°C	-	± 66	-	mV
		$T_A = -40^\circ\text{C}$, 25°C	-	± 66	-	mV

[1] Typical values with \pm are mean ± 3 sigma values, except for lifetime drift which are the average value including drift after AEC-Q100 qualification.

[2] A single part will not have both the maximum sensitivity error and the maximum offset voltage, as that would violate the maximum/minimum total output error specification. For total error, 3 sigma distribution values for offset and sensitivity may be combined by taking the square root of the sum of the squares. See characteristic performance data plots for temperature drift performance.

[3] Percentage of I_P , with $I_P = I_{PR(MAX)}$.

[4] The sensor will continue to respond to current beyond the range of I_{PR} until the high or low output saturation voltage. However, the nonlinearity in this region may be worse than the nominal operating range.

[5] Lifetime drift characteristics are based on AEC-Q100 qualification results. Typical values are mean ± 3 sigma of worst case stress testing. Drift is a function of customer application conditions. Contact Allegro MicroSystems for further information.

ACS732 and ACS733

1 MHz Bandwidth, Galvanically Isolated Current Sensor IC in SOIC-16 Package

ACS732KLATR-65AU PERFORMANCE CHARACTERISTICS: Valid at $T_A = -40^\circ\text{C}$ to 125°C , $V_{CC} = 5\text{ V}$, $C_{BYPASS} = 0.1\ \mu\text{F}$, unless otherwise specified

Characteristic	Symbol	Test Conditions	Min.	Typ. [1]	Max.	Unit
NOMINAL PERFORMANCE						
Current Sensing Range	I_{PR}		0	–	65	A
Sensitivity	Sens		–	60	–	mV/A
Zero Current Output Voltage	$V_{IOUT(Q)}$	Unidirectional, $I_P = 0\text{ A}$	–	$0.1 \times V_{CC}$	–	V
TOTAL OUTPUT ERROR COMPONENTS [2] $E_{TOT} = E_{SENS} + 100 \times V_{OE} / (\text{Sens} \times I_P)$						
Total Output Error [3]	E_{TOT}	$I_P = I_{PR(max)}$, $T_A = 25^\circ\text{C}$	–2.5	± 1.8	2.5	%
		$I_P = I_{PR(max)}$, $T_A = 125^\circ\text{C}$	–3	± 2	3	%
		$I_P = I_{PR(max)}$, $T_A = 25^\circ\text{C}$ to 125°C	–	± 2.9	–	%
		$I_P = I_{PR(max)}$, $T_A = -40^\circ\text{C}$	–8	± 4.5	8	%
Sensitivity Error	E_{SENS}	$I_P = I_{PR(max)} / 2$, $T_A = 25^\circ\text{C}$	–1.5	± 0.75	1.5	%
		$I_P = I_{PR(max)} / 2$, $T_A = 125^\circ\text{C}$	–1.5	± 1.25	1.5	%
		$I_P = I_{PR(max)} / 2$, $T_A = -40^\circ\text{C}$	–4	± 2	4	%
Voltage Offset Error	V_{OE}	$I_P = 0\text{ A}$, $T_A = 25^\circ\text{C}$	–55	± 30	55	mV
		$I_P = 0\text{ A}$, $T_A = 125^\circ\text{C}$	–25	± 18	25	mV
		$I_P = 0\text{ A}$, $T_A = 25^\circ\text{C}$ to 125°C	–	± 50	–	mV
		$I_P = 0\text{ A}$, $T_A = -40^\circ\text{C}$	–120	± 100	120	mV
Linearity Error [4]	E_{LIN}	$T_A = 25^\circ\text{C}$, up to full-scale I_P	–2.5	± 1.8	2.5	%
		$T_A = 125^\circ\text{C}$, up to full-scale I_P	–	± 0.7	–	%
		$T_A = -40^\circ\text{C}$, up to full-scale I_P	–	± 4.2	–	%
LIFETIME DRIFT CHARACTERISTICS [5]						
Total Output Error Including Lifetime Drift	$E_{TOT(DRIFT)}$	$I_P = I_{PR(max)}$, $T_A = 25^\circ\text{C}$, 125°C	–	± 7.4	–	%
		$I_P = I_{PR(max)}$, $T_A = -40^\circ\text{C}$, 25°C	–	± 7.4	–	%
Sensitivity Error Including Lifetime Drift	$E_{SENS(DRIFT)}$	$I_P = I_{PR(max)} / 2$, $T_A = 25^\circ\text{C}$, 125°C	–	± 2.2	–	%
		$I_P = I_{PR(max)} / 2$, $T_A = -40^\circ\text{C}$, 25°C	–	± 3.3	–	%
Offset Voltage Error Including Lifetime Drift	$V_{OE(DRIFT)}$	$T_A = 25^\circ\text{C}$, 125°C	–	± 132	–	mV
		$T_A = -40^\circ\text{C}$, 25°C	–	± 132	–	mV

[1] Typical values with \pm are mean ± 3 sigma values, except for lifetime drift which are the average value including drift after AEC-Q100 qualification.

[2] A single part will not have both the maximum sensitivity error and the maximum offset voltage, as that would violate the maximum/minimum total output error specification. For total error, 3 sigma distribution values for offset and sensitivity may be combined by taking the square root of the sum of the squares. See characteristic performance data plots for temperature drift performance.

[3] Percentage of I_P , with $I_P = I_{PR(MAX)}$.

[4] The sensor will continue to respond to current beyond the range of I_{PR} until the high or low output saturation voltage. However, the nonlinearity in this region may be worse than the nominal operating range.

[5] Lifetime drift characteristics are based on AEC-Q100 qualification results. Typical values are mean ± 3 sigma of worst case stress testing. Drift is a function of customer application conditions. Contact Allegro MicroSystems for further information.

ACS732 and ACS733

1 MHz Bandwidth, Galvanically Isolated Current Sensor IC in SOIC-16 Package

ACS732KLATR-75AB PERFORMANCE CHARACTERISTICS: Valid at $T_A = -40^\circ\text{C}$ to 125°C , $V_{CC} = 5\text{ V}$, $C_{BYPASS} = 0.1\ \mu\text{F}$, unless otherwise specified

Characteristic	Symbol	Test Conditions	Min.	Typ. [1]	Max.	Unit
NOMINAL PERFORMANCE						
Current Sensing Range [2]	I_{PR}		-75	-	75	A
Sensitivity	Sens		-	26.6	-	mV/A
Zero Current Output Voltage	$V_{IOUT(Q)}$	Bidirectional, $I_P = 0\text{ A}$	-	$0.5 \times V_{CC}$	-	V
TOTAL OUTPUT ERROR COMPONENTS [3] $E_{TOT} = E_{SENS} + 100 \times V_{OE} / (\text{Sens} \times I_P)$						
Total Output Error [4]	E_{TOT}	$I_P = I_{PR(max)}$, $T_A = 25^\circ\text{C}$	-2.5	± 1.6	2.5	%
		$I_P = I_{PR(max)}$, $T_A = 125^\circ\text{C}$	-2.5	± 1	2.5	%
		$I_P = I_{PR(max)}$, $T_A = 25^\circ\text{C}$ to 125°C	-	± 2.6	-	%
		$I_P = I_{PR(max)}$, $T_A = -40^\circ\text{C}$	-6.5	± 3.4	6.5	%
Sensitivity Error	E_{SENS}	$I_P = I_{PR(max)} / 2$, $T_A = 25^\circ\text{C}$	-2	± 1.5	2	%
		$I_P = I_{PR(max)} / 2$, $T_A = 125^\circ\text{C}$	-2	± 0.9	2	%
		$I_P = I_{PR(max)} / 2$, $T_A = -40^\circ\text{C}$	-4	± 2.7	4	%
Voltage Offset Error	V_{OE}	$I_P = 0\text{ A}$, $T_A = 25^\circ\text{C}$	-45	± 27	45	mV
		$I_P = 0\text{ A}$, $T_A = 125^\circ\text{C}$	-25	± 8	25	mV
		$I_P = 0\text{ A}$, $T_A = 25^\circ\text{C}$ to 125°C	-	± 45	-	mV
		$I_P = 0\text{ A}$, $T_A = -40^\circ\text{C}$	-95	± 58	95	mV
Linearity Error [5]	E_{LIN}	$T_A = 25^\circ\text{C}$, up to full-scale I_P	-2.9	± 2.3	2.9	%
		$T_A = 125^\circ\text{C}$, up to full-scale I_P	-	± 1	-	%
		$T_A = -40^\circ\text{C}$, up to full-scale I_P	-	± 8.1	-	%
LIFETIME DRIFT CHARACTERISTICS [6]						
Total Output Error Including Lifetime Drift	$E_{TOT(DRIFT)}$	$I_P = I_{PR(max)}$, $T_A = 25^\circ\text{C}$, 125°C	-	± 4.4	-	%
		$I_P = I_{PR(max)}$, $T_A = -40^\circ\text{C}$, 25°C	-	± 4.4	-	%
Sensitivity Error Including Lifetime Drift	$E_{SENS(DRIFT)}$	$I_P = I_{PR(max)} / 2$, $T_A = 25^\circ\text{C}$, 125°C	-	± 2.2	-	%
		$I_P = I_{PR(max)} / 2$, $T_A = -40^\circ\text{C}$, 25°C	-	± 3.3	-	%
Offset Voltage Error Including Lifetime Drift	$V_{OE(DRIFT)}$	$T_A = 25^\circ\text{C}$, 125°C	-	± 59	-	mV
		$T_A = -40^\circ\text{C}$, 25°C	-	± 59	-	mV

[1] Typical values with \pm are mean ± 3 sigma values, except for lifetime drift which are the average value including drift after AEC-Q100 qualification.

[2] Devices trimmed at half-scale I_P . Operating above this limit may result in decreased accuracy.

[3] A single part will not have both the maximum sensitivity error and the maximum offset voltage, as that would violate the maximum/minimum total output error specification. For total error, 3 sigma distribution values for offset and sensitivity may be combined by taking the square root of the sum of the squares. See characteristic performance data plots for temperature drift performance.

[4] Percentage of I_P , with $I_P = I_{PR(MAX)} / 2$.

[5] The sensor will continue to respond to current beyond the range of I_{PR} until the high or low output saturation voltage. However, the nonlinearity in this region may be worse than the nominal operating range.

[6] Lifetime drift characteristics are based on AEC-Q100 qualification results. Typical values are mean ± 3 sigma of worst case stress testing. Drift is a function of customer application conditions. Contact Allegro MicroSystems for further information.

ACS732 and ACS733

1 MHz Bandwidth, Galvanically Isolated Current Sensor IC in SOIC-16 Package

ACS733KLATR-20AB PERFORMANCE CHARACTERISTICS: Valid at $T_A = -40^\circ\text{C}$ to 125°C , $V_{CC} = 3.3\text{ V}$, $C_{BYPASS} = 0.1\ \mu\text{F}$, unless otherwise specified

Characteristic	Symbol	Test Conditions	Min.	Typ. [1]	Max.	Unit
NOMINAL PERFORMANCE						
Current Sensing Range	I_{PR}		-20	-	20	A
Sensitivity	Sens		-	66	-	mV/A
Zero Current Output Voltage	$V_{IOUT(Q)}$	Bidirectional, $I_P = 0\text{ A}$	-	$0.5 \times V_{CC}$	-	V
TOTAL OUTPUT ERROR COMPONENTS [2] $E_{TOT} = E_{SENS} + 100 \times V_{OE} / (\text{Sens} \times I_P)$						
Total Output Error [3]	E_{TOT}	$I_P = I_{PR(max)}$, $T_A = 25^\circ\text{C}$	-4.5	± 1.7	4.5	%
		$I_P = I_{PR(max)}$, $T_A = 125^\circ\text{C}$	-3	± 1.25	3	%
		$I_P = I_{PR(max)}$, $T_A = 25^\circ\text{C}$ to 125°C	-	± 2.8	-	%
		$I_P = I_{PR(max)}$, $T_A = -40^\circ\text{C}$	-10	± 5	10	%
Sensitivity Error	E_{SENS}	$I_P = I_{PR(max)} / 2$, $T_A = 25^\circ\text{C}$	-1.5	± 1	1.5	%
		$I_P = I_{PR(max)} / 2$, $T_A = 125^\circ\text{C}$	-1.5	± 0.8	1.5	%
		$I_P = I_{PR(max)} / 2$, $T_A = -40^\circ\text{C}$	-3	± 2	3	%
Voltage Offset Error	V_{OE}	$I_P = 0\text{ A}$, $T_A = 25^\circ\text{C}$	-55	± 21	55	mV
		$I_P = 0\text{ A}$, $T_A = 125^\circ\text{C}$	-25	± 10	25	mV
		$I_P = 0\text{ A}$, $T_A = 25^\circ\text{C}$ to 125°C	-	± 35	-	mV
		$I_P = 0\text{ A}$, $T_A = -40^\circ\text{C}$	-120	± 80	120	mV
Linearity Error [4]	E_{LIN}	$T_A = 25^\circ\text{C}$, up to full-scale I_P	-1	± 0.3	1	%
		$T_A = 125^\circ\text{C}$, up to full-scale I_P	-	± 0.4	-	%
		$T_A = -40^\circ\text{C}$, up to full-scale I_P	-	± 0.4	-	%
LIFETIME DRIFT CHARACTERISTICS [5]						
Total Output Error Including Lifetime Drift	$E_{TOT(DRIFT)}$	$I_P = I_{PR(max)}$, $T_A = 25^\circ\text{C}$, 125°C	-	± 9.8	-	%
		$I_P = I_{PR(max)}$, $T_A = -40^\circ\text{C}$, 25°C	-	± 9.8	-	%
Sensitivity Error Including Lifetime Drift	$E_{SENS(DRIFT)}$	$I_P = I_{PR(max)} / 2$, $T_A = 25^\circ\text{C}$, 125°C	-	± 2.2	-	%
		$I_P = I_{PR(max)} / 2$, $T_A = -40^\circ\text{C}$, 25°C	-	± 3.3	-	%
Offset Voltage Error Including Lifetime Drift	$V_{OE(DRIFT)}$	$T_A = 25^\circ\text{C}$, 125°C	-	± 145	-	mV
		$T_A = -40^\circ\text{C}$, 25°C	-	± 145	-	mV

[1] Typical values with \pm are mean ± 3 sigma values, except for lifetime drift which are the average value including drift after AEC-Q100 qualification.

[2] A single part will not have both the maximum sensitivity error and the maximum offset voltage, as that would violate the maximum/minimum total output error specification. For total error, 3 sigma distribution values for offset and sensitivity may be combined by taking the square root of the sum of the squares. See characteristic performance data plots for temperature drift performance.

[3] Percentage of I_P , with $I_P = I_{PR(MAX)}$.

[4] The sensor will continue to respond to current beyond the range of I_{PR} until the high or low output saturation voltage. However, the nonlinearity in this region may be worse than the nominal operating range.

[5] Lifetime drift characteristics are based on AEC-Q100 qualification results. Typical values are mean ± 3 sigma of worst case stress testing. Drift is a function of customer application conditions. Contact Allegro MicroSystems for further information.

ACS732 and ACS733

1 MHz Bandwidth, Galvanically Isolated Current Sensor IC in SOIC-16 Package

ACS733KLATR-20AB-H PERFORMANCE CHARACTERISTICS: Valid at $T_A = -40^\circ\text{C}$ to 125°C , $V_{CC} = 3.3\text{ V}$, $C_{BYPASS} = 0.1\ \mu\text{F}$, unless otherwise specified

Characteristic	Symbol	Test Conditions	Min.	Typ. [1]	Max.	Unit
NOMINAL PERFORMANCE						
Current Sensing Range	I_{PR}		-20	-	20	A
Sensitivity	Sens		-	66	-	mV/A
Zero Current Output Voltage	$V_{IOUT(Q)}$	Bidirectional, $I_P = 0\text{ A}$	-	$0.5 \times V_{CC}$	-	V
TOTAL OUTPUT ERROR COMPONENTS [2] $E_{TOT} = E_{SENS} + 100 \times V_{OE} / (\text{Sens} \times I_P)$						
Total Output Error [3]	E_{TOT}	$I_P = I_{PR(max)}$, $T_A = 25^\circ\text{C}$	-4.5	± 1.7	4.5	%
		$I_P = I_{PR(max)}$, $T_A = 125^\circ\text{C}$	-3	± 1.25	3	%
		$I_P = I_{PR(max)}$, $T_A = 25^\circ\text{C}$ to 125°C	-	± 2.8	-	%
		$I_P = I_{PR(max)}$, $T_A = -40^\circ\text{C}$	-4.5	± 1.7	4.5	%
Sensitivity Error	E_{SENS}	$I_P = I_{PR(max)} / 2$, $T_A = 25^\circ\text{C}$	-1.5	± 1	1.5	%
		$I_P = I_{PR(max)} / 2$, $T_A = 125^\circ\text{C}$	-1.5	± 0.8	1.5	%
		$I_P = I_{PR(max)} / 2$, $T_A = -40^\circ\text{C}$	-1.5	± 1	1.5	%
Voltage Offset Error	V_{OE}	$I_P = 0\text{ A}$, $T_A = 25^\circ\text{C}$	-55	± 21	55	mV
		$I_P = 0\text{ A}$, $T_A = 125^\circ\text{C}$	-25	± 10	25	mV
		$I_P = 0\text{ A}$, $T_A = 25^\circ\text{C}$ to 125°C	-	± 35	-	mV
		$I_P = 0\text{ A}$, $T_A = -40^\circ\text{C}$	-55	± 21	55	mV
Linearity Error [4]	E_{LIN}	$T_A = 25^\circ\text{C}$, up to full-scale I_P	-1	± 0.3	1	%
		$T_A = 125^\circ\text{C}$, up to full-scale I_P	-	± 0.4	-	%
		$T_A = -40^\circ\text{C}$, up to full-scale I_P	-	± 0.4	-	%
LIFETIME DRIFT CHARACTERISTICS [5]						
Total Output Error Including Lifetime Drift	$E_{TOT(DRIFT)}$	$I_P = I_{PR(max)}$, $T_A = 25^\circ\text{C}$, 125°C	-	± 9.8	-	%
		$I_P = I_{PR(max)}$, $T_A = -40^\circ\text{C}$, 25°C	-	± 9.8	-	%
Sensitivity Error Including Lifetime Drift	$E_{SENS(DRIFT)}$	$I_P = I_{PR(max)} / 2$, $T_A = 25^\circ\text{C}$, 125°C	-	± 2.2	-	%
		$I_P = I_{PR(max)} / 2$, $T_A = -40^\circ\text{C}$, 25°C	-	± 3.3	-	%
Offset Voltage Error Including Lifetime Drift	$V_{OE(DRIFT)}$	$T_A = 25^\circ\text{C}$, 125°C	-	± 145	-	mV
		$T_A = -40^\circ\text{C}$, 25°C	-	± 145	-	mV

[1] Typical values with \pm are mean ± 3 sigma values, except for lifetime drift which are the average value including drift after AEC-Q100 qualification.

[2] A single part will not have both the maximum sensitivity error and the maximum offset voltage, as that would violate the maximum/minimum total output error specification. For total error, 3 sigma distribution values for offset and sensitivity may be combined by taking the square root of the sum of the squares. See characteristic performance data plots for temperature drift performance.

[3] Percentage of I_P , with $I_P = I_{PR(MAX)}$.

[4] The sensor will continue to respond to current beyond the range of I_{PR} until the high or low output saturation voltage. However, the nonlinearity in this region may be worse than the nominal operating range.

[5] Lifetime drift characteristics are based on AEC-Q100 qualification results. Typical values are mean ± 3 sigma of worst case stress testing. Drift is a function of customer application conditions. Contact Allegro MicroSystems for further information.

ACS732 and ACS733

1 MHz Bandwidth, Galvanically Isolated Current Sensor IC in SOIC-16 Package

ACS733KLATR-40AB PERFORMANCE CHARACTERISTICS: Valid at $T_A = -40^\circ\text{C}$ to 125°C , $V_{CC} = 3.3\text{ V}$, $C_{BYPASS} = 0.1\ \mu\text{F}$, unless otherwise specified

Characteristic	Symbol	Test Conditions	Min.	Typ. [1]	Max.	Unit
NOMINAL PERFORMANCE						
Current Sensing Range	I_{PR}		-40	-	40	A
Sensitivity	Sens		-	33	-	mV/A
Zero Current Output Voltage	$V_{IOUT(Q)}$	Bidirectional, $I_P = 0\text{ A}$	-	$0.5 \times V_{CC}$	-	V
TOTAL OUTPUT ERROR COMPONENTS [2] $E_{TOT} = E_{SENS} + 100 \times V_{OE} / (\text{Sens} \times I_P)$						
Total Output Error [3]	E_{TOT}	$I_P = I_{PR(max)}$, $T_A = 25^\circ\text{C}$	-3	± 1.4	3	%
		$I_P = I_{PR(max)}$, $T_A = 125^\circ\text{C}$	-2	± 1.25	2	%
		$I_P = I_{PR(max)}$, $T_A = 25^\circ\text{C}$ to 125°C	-	± 2.3	-	%
		$I_P = I_{PR(max)}$, $T_A = -40^\circ\text{C}$	-6.5	± 3	6.5	%
Sensitivity Error	E_{SENS}	$I_P = I_{PR(max)} / 2$, $T_A = 25^\circ\text{C}$	-1.5	± 1.3	1.5	%
		$I_P = I_{PR(max)} / 2$, $T_A = 125^\circ\text{C}$	-2	± 1	2	%
		$I_P = I_{PR(max)} / 2$, $T_A = -40^\circ\text{C}$	-4.5	± 2.2	4.5	%
Voltage Offset Error	V_{OE}	$I_P = 0\text{ A}$, $T_A = 25^\circ\text{C}$	-40	± 9	40	mV
		$I_P = 0\text{ A}$, $T_A = 125^\circ\text{C}$	-40	± 7	40	mV
		$I_P = 0\text{ A}$, $T_A = 25^\circ\text{C}$ to 125°C	-	± 15	-	mV
		$I_P = 0\text{ A}$, $T_A = -40^\circ\text{C}$	-75	± 35	75	mV
Linearity Error [4]	E_{LIN}	$T_A = 25^\circ\text{C}$, up to full-scale I_P	-1	± 0.5	1	%
		$T_A = 125^\circ\text{C}$, up to full-scale I_P	-	± 0.3	-	%
		$T_A = -40^\circ\text{C}$, up to full-scale I_P	-	± 1.3	-	%
LIFETIME DRIFT CHARACTERISTICS [5]						
Total Output Error Including Lifetime Drift	$E_{TOT(DRIFT)}$	$I_P = I_{PR(max)}$, $T_A = 25^\circ\text{C}$, 125°C	-	± 4.9	-	%
		$I_P = I_{PR(max)}$, $T_A = -40^\circ\text{C}$, 25°C	-	± 4.9	-	%
Sensitivity Error Including Lifetime Drift	$E_{SENS(DRIFT)}$	$I_P = I_{PR(max)} / 2$, $T_A = 25^\circ\text{C}$, 125°C	-	± 2.2	-	%
		$I_P = I_{PR(max)} / 2$, $T_A = -40^\circ\text{C}$, 25°C	-	± 3.3	-	%
Offset Voltage Error Including Lifetime Drift	$V_{OE(DRIFT)}$	$T_A = 25^\circ\text{C}$, 125°C	-	± 73	-	mV
		$T_A = -40^\circ\text{C}$, 25°C	-	± 73	-	mV

[1] Typical values with \pm are mean ± 3 sigma values, except for lifetime drift which are the average value including drift after AEC-Q100 qualification.

[2] A single part will not have both the maximum sensitivity error and the maximum offset voltage, as that would violate the maximum/minimum total output error specification. For total error, 3 sigma distribution values for offset and sensitivity may be combined by taking the square root of the sum of the squares. See characteristic performance data plots for temperature drift performance.

[3] Percentage of I_P , with $I_P = I_{PR(MAX)}$.

[4] The sensor will continue to respond to current beyond the range of I_{PR} until the high or low output saturation voltage. However, the nonlinearity in this region may be worse than the nominal operating range.

[5] Lifetime drift characteristics are based on AEC-Q100 qualification results. Typical values are mean ± 3 sigma of worst case stress testing. Drift is a function of customer application conditions. Contact Allegro MicroSystems for further information.

ACS732 and ACS733

1 MHz Bandwidth, Galvanically Isolated Current Sensor IC in SOIC-16 Package

ACS733KLATR-40AU PERFORMANCE CHARACTERISTICS: Valid at $T_A = -40^\circ\text{C}$ to 125°C , $V_{CC} = 3.3\text{ V}$, $C_{BYPASS} = 0.1\ \mu\text{F}$, unless otherwise specified

Characteristic	Symbol	Test Conditions	Min.	Typ. [1]	Max.	Unit
NOMINAL PERFORMANCE						
Current Sensing Range	I_{PR}		0	–	40	A
Sensitivity	Sens		–	66	–	mV/A
Zero Current Output Voltage	$V_{IOUT(Q)}$	Unidirectional, $I_P = 0\text{ A}$	–	$0.1 \times V_{CC}$	–	V
TOTAL OUTPUT ERROR COMPONENTS [2] $E_{TOT} = E_{SENS} + 100 \times V_{OE} / (\text{Sens} \times I_P)$						
Total Output Error [3]	E_{TOT}	$I_P = I_{PR(max)}$, $T_A = 25^\circ\text{C}$	–2.5	± 1	2.5	%
		$I_P = I_{PR(max)}$, $T_A = 125^\circ\text{C}$	–2.5	± 1	2.5	%
		$I_P = I_{PR(max)}$, $T_A = 25^\circ\text{C}$ to 125°C	–	± 1.6	–	%
		$I_P = I_{PR(max)}$, $T_A = -40^\circ\text{C}$	–6.5	± 3.3	6.5	%
Sensitivity Error	E_{SENS}	$I_P = I_{PR(max)} / 2$, $T_A = 25^\circ\text{C}$	–1.5	± 0.9	1.5	%
		$I_P = I_{PR(max)} / 2$, $T_A = 125^\circ\text{C}$	–1.5	± 0.9	1.5	%
		$I_P = I_{PR(max)} / 2$, $T_A = -40^\circ\text{C}$	–4	± 2.7	4	%
Voltage Offset Error	V_{OE}	$I_P = 0\text{ A}$, $T_A = 25^\circ\text{C}$	–30	± 17	30	mV
		$I_P = 0\text{ A}$, $T_A = 125^\circ\text{C}$	–25	± 12	25	mV
		$I_P = 0\text{ A}$, $T_A = 25^\circ\text{C}$ to 125°C	–	± 28	–	mV
		$I_P = 0\text{ A}$, $T_A = -40^\circ\text{C}$	–110	± 70	110	mV
Linearity Error [4]	E_{LIN}	$T_A = 25^\circ\text{C}$, up to full-scale I_P	–1	± 0.4	1	%
		$T_A = 125^\circ\text{C}$, up to full-scale I_P	–	± 0.3	–	%
		$T_A = -40^\circ\text{C}$, up to full-scale I_P	–	± 1.3	–	%
LIFETIME DRIFT CHARACTERISTICS [5]						
Total Output Error Including Lifetime Drift	$E_{TOT(DRIFT)}$	$I_P = I_{PR(max)}$, $T_A = 25^\circ\text{C}$, 125°C	–	± 8	–	%
		$I_P = I_{PR(max)}$, $T_A = -40^\circ\text{C}$, 25°C	–	± 8	–	%
Sensitivity Error Including Lifetime Drift	$E_{SENS(DRIFT)}$	$I_P = I_{PR(max)} / 2$, $T_A = 25^\circ\text{C}$, 125°C	–	± 2.2	–	%
		$I_P = I_{PR(max)} / 2$, $T_A = -40^\circ\text{C}$, 25°C	–	± 3.3	–	%
Offset Voltage Error Including Lifetime Drift	$V_{OE(DRIFT)}$	$T_A = 25^\circ\text{C}$, 125°C	–	± 145	–	mV
		$T_A = -40^\circ\text{C}$, 25°C	–	± 145	–	mV

[1] Typical values with \pm are mean ± 3 sigma values, except for lifetime drift which are the average value including drift after AEC-Q100 qualification.

[2] A single part will not have both the maximum sensitivity error and the maximum offset voltage, as that would violate the maximum/minimum total output error specification. For total error, 3 sigma distribution values for offset and sensitivity may be combined by taking the square root of the sum of the squares. See characteristic performance data plots for temperature drift performance.

[3] Percentage of I_P , with $I_P = I_{PR(MAX)}$.

[4] The sensor will continue to respond to current beyond the range of I_{PR} until the high or low output saturation voltage. However, the nonlinearity in this region may be worse than the nominal operating range.

[5] Lifetime drift characteristics are based on AEC-Q100 qualification results. Typical values are mean ± 3 sigma of worst case stress testing. Drift is a function of customer application conditions. Contact Allegro MicroSystems for further information.

ACS732 and ACS733

1 MHz Bandwidth, Galvanically Isolated Current Sensor IC in SOIC-16 Package

ACS733KLATR-65AB PERFORMANCE CHARACTERISTICS: Valid at $T_A = -40^\circ\text{C}$ to 125°C , $V_{CC} = 3.3\text{ V}$, $C_{BYPASS} = 0.1\ \mu\text{F}$, unless otherwise specified

Characteristic	Symbol	Test Conditions	Min.	Typ. [1]	Max.	Unit
NOMINAL PERFORMANCE						
Current Sensing Range	I_{PR}		-65	-	65	A
Sensitivity	Sens		-	20	-	mV/A
Zero Current Output Voltage	$V_{IOUT(Q)}$	Bidirectional, $I_P = 0\text{ A}$	-	$0.5 \times V_{CC}$	-	V
TOTAL OUTPUT ERROR COMPONENTS [2] $E_{TOT} = E_{SENS} + 100 \times V_{OE} / (\text{Sens} \times I_P)$						
Total Output Error [3]	E_{TOT}	$I_P = I_{PR(max)}$, $T_A = 25^\circ\text{C}$	-3.5	± 1.8	3.5	%
		$I_P = I_{PR(max)}$, $T_A = 125^\circ\text{C}$	-3	± 1.4	3	%
		$I_P = I_{PR(max)}$, $T_A = 25^\circ\text{C}$ to 125°C	-	± 2.9	-	%
		$I_P = I_{PR(max)}$, $T_A = -40^\circ\text{C}$	-6	± 4	6	%
Sensitivity Error	E_{SENS}	$I_P = I_{PR(max)} / 2$, $T_A = 25^\circ\text{C}$	-2.5	± 1.6	2.5	%
		$I_P = I_{PR(max)} / 2$, $T_A = 125^\circ\text{C}$	-2.5	± 1.6	2.5	%
		$I_P = I_{PR(max)} / 2$, $T_A = -40^\circ\text{C}$	-4.5	± 3.1	4.5	%
Voltage Offset Error	V_{OE}	$I_P = 0\text{ A}$, $T_A = 25^\circ\text{C}$	-30	± 17	30	mV
		$I_P = 0\text{ A}$, $T_A = 125^\circ\text{C}$	-25	± 7	25	mV
		$I_P = 0\text{ A}$, $T_A = 25^\circ\text{C}$ to 125°C	-	± 28	-	mV
		$I_P = 0\text{ A}$, $T_A = -40^\circ\text{C}$	-70	± 31	70	mV
Linearity Error [4]	E_{LIN}	$T_A = 25^\circ\text{C}$, up to full-scale I_P	-1.7	± 1.1	1.7	%
		$T_A = 125^\circ\text{C}$, up to full-scale I_P	-	± 0.5	-	%
		$T_A = -40^\circ\text{C}$, up to full-scale I_P	-	± 2.8	-	%
LIFETIME DRIFT CHARACTERISTICS [5]						
Total Output Error Including Lifetime Drift	$E_{TOT(DRIFT)}$	$I_P = I_{PR(max)}$, $T_A = 25^\circ\text{C}$, 125°C	-	± 4	-	%
		$I_P = I_{PR(max)}$, $T_A = -40^\circ\text{C}$, 25°C	-	± 4	-	%
Sensitivity Error Including Lifetime Drift	$E_{SENS(DRIFT)}$	$I_P = I_{PR(max)} / 2$, $T_A = 25^\circ\text{C}$, 125°C	-	± 2.2	-	%
		$I_P = I_{PR(max)} / 2$, $T_A = -40^\circ\text{C}$, 25°C	-	± 3.3	-	%
Offset Voltage Error Including Lifetime Drift	$V_{OE(DRIFT)}$	$T_A = 25^\circ\text{C}$, 125°C	-	± 44	-	mV
		$T_A = -40^\circ\text{C}$, 25°C	-	± 44	-	mV

[1] Typical values with \pm are mean ± 3 sigma values, except for lifetime drift which are the average value including drift after AEC-Q100 qualification.

[2] A single part will not have both the maximum sensitivity error and the maximum offset voltage, as that would violate the maximum/minimum total output error specification. For total error, 3 sigma distribution values for offset and sensitivity may be combined by taking the square root of the sum of the squares. See characteristic performance data plots for temperature drift performance.

[3] Percentage of I_P , with $I_P = I_{PR(MAX)}$.

[4] The sensor will continue to respond to current beyond the range of I_{PR} until the high or low output saturation voltage. However, the nonlinearity in this region may be worse than the nominal operating range.

[5] Lifetime drift characteristics are based on AEC-Q100 qualification results. Typical values are mean ± 3 sigma of worst case stress testing. Drift is a function of customer application conditions. Contact Allegro MicroSystems for further information.

CHARACTERISTIC PERFORMANCE ACS732KLATR-40AB-T (5 V)

for ~150 parts

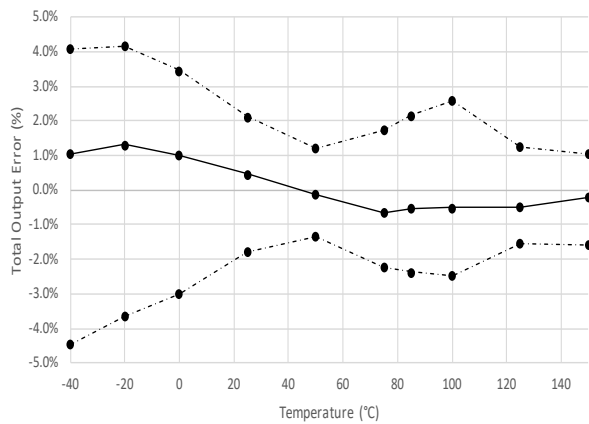
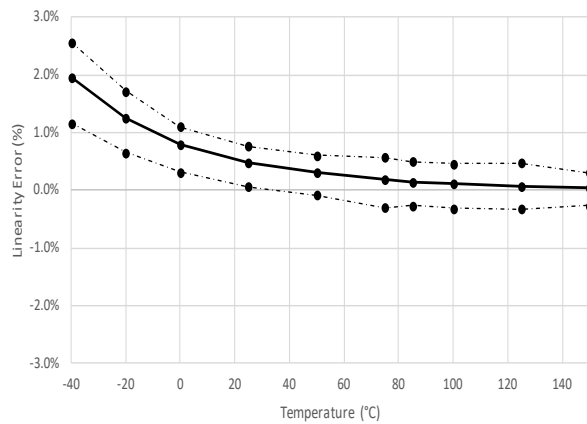
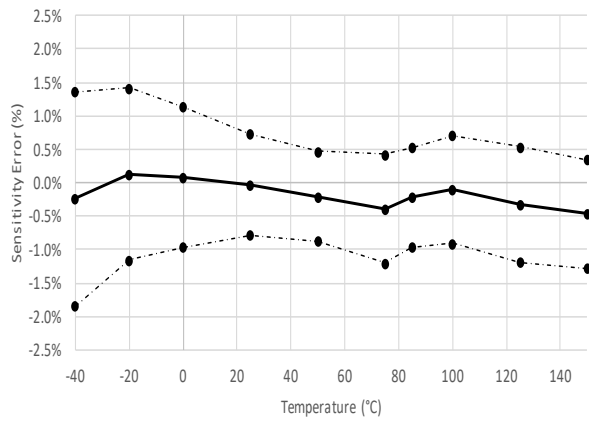
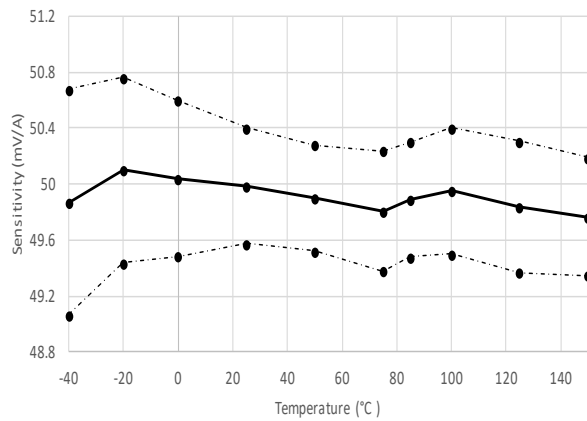
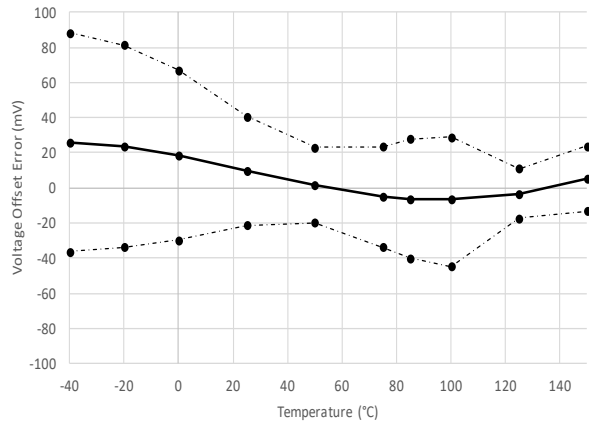
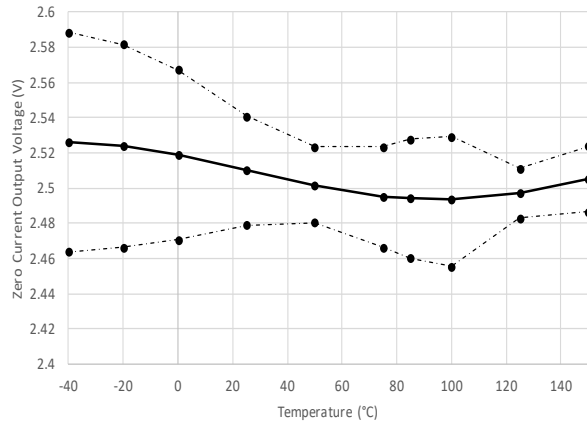

— μ - - - $\mu \pm 3\sigma$

CHARACTERISTIC PERFORMANCE ACS733KLA-40AU-T (3.3 V)

for ~50 parts

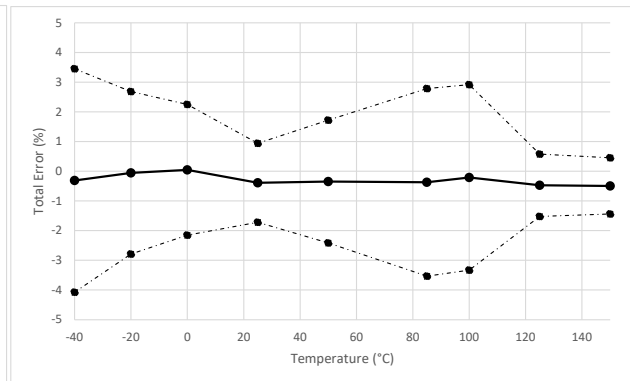
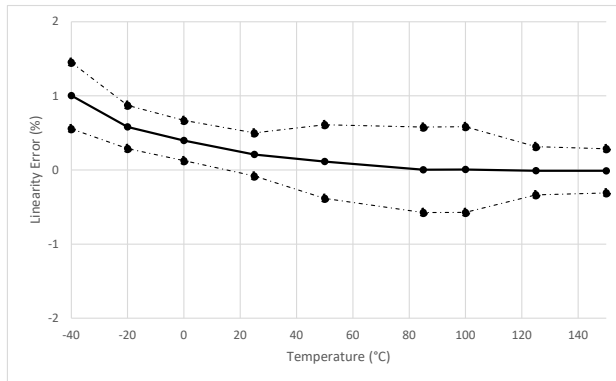
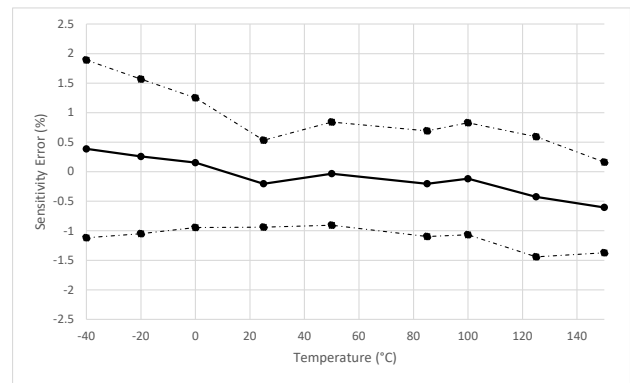
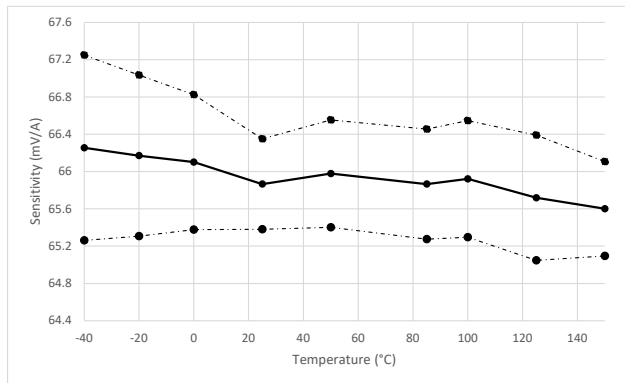
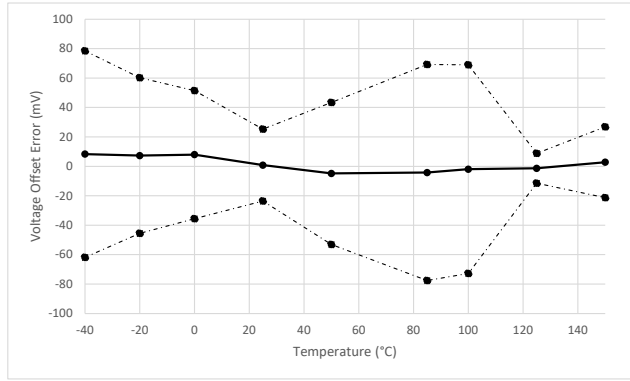
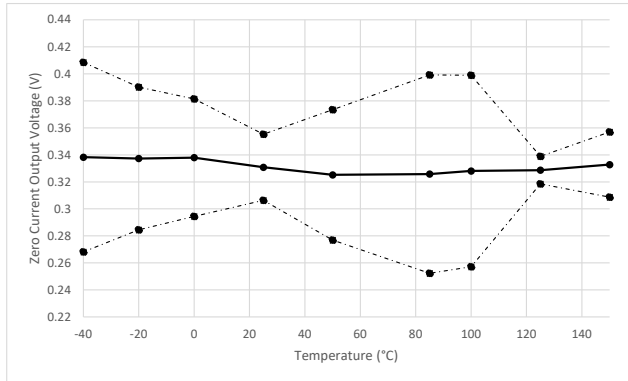

— μ - - - μ ± 3σ

CHARACTERISTIC PERFORMANCE ACS732 AND ACS733 TYPICAL FREQUENCY RESPONSE

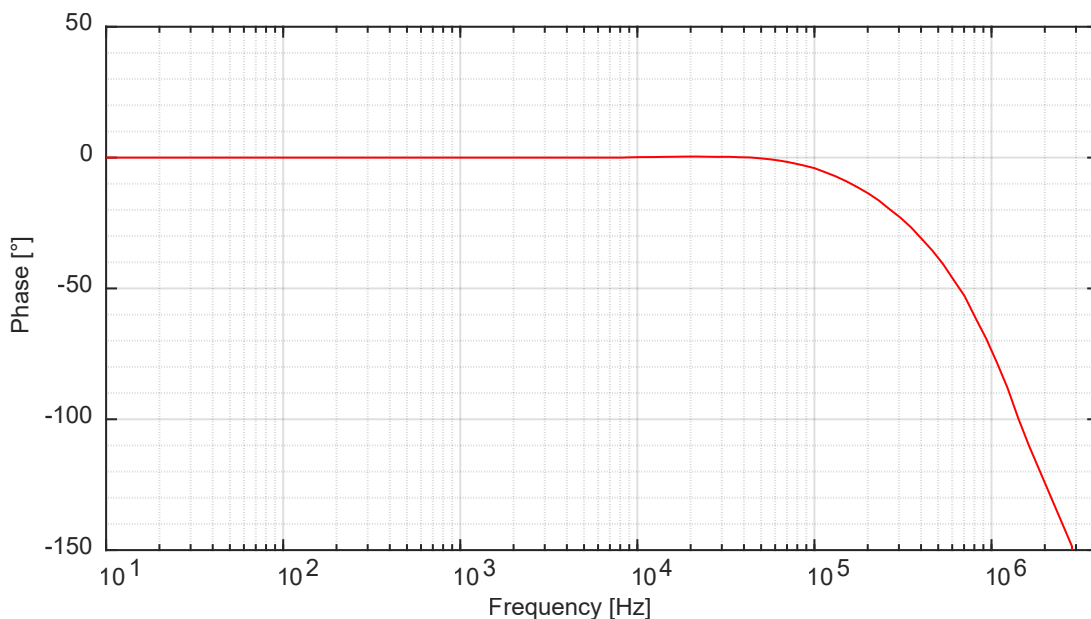
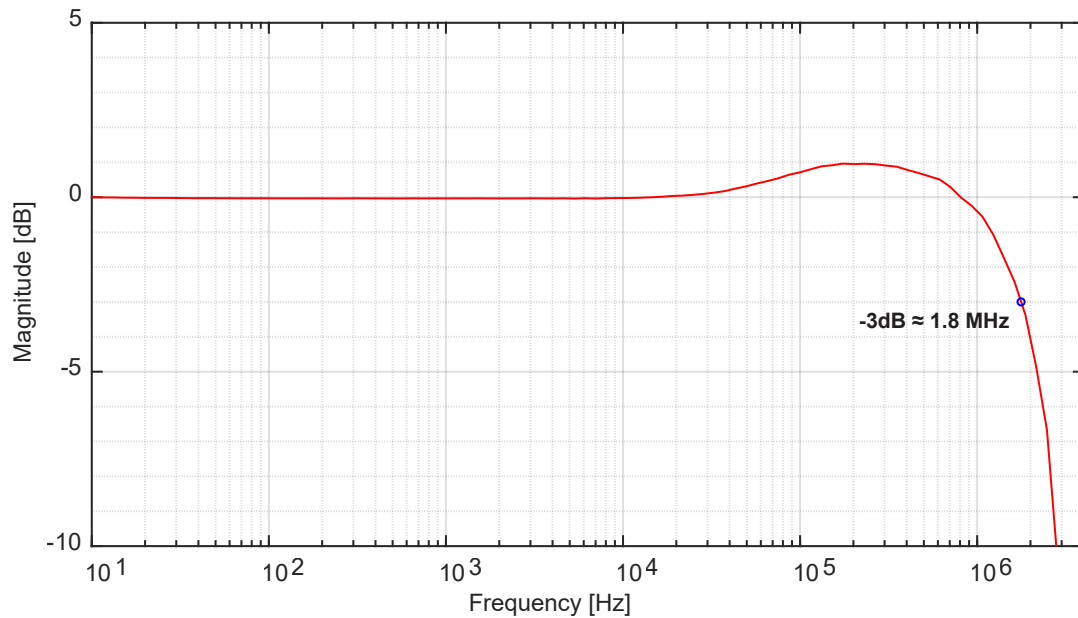

For information regarding bandwidth characterization methods used for the ACS732 and ACS733, see the “Characterizing System Bandwidth” application note (<https://allegromicro.com/en/insights-and-innovations/technical-documents/hall-effect-sensor-ic-publications/an296169-acs720-bandwidth-testing>) on the Allegro website.

RESPONSE CHARACTERISTICS DEFINITIONS AND PERFORMANCE DATA

Response Time (t_{RESPONSE})

The time interval between a) when the sensed input current reaches 90% of its final value, and b) when the sensor output reaches 90% of its full-scale value.

Propagation Delay (t_{pd})

The time interval between a) when the sensed input current reaches 20% of its full-scale value, and b) when the sensor output reaches 20% of its full-scale value.

Rise Time (t_r)

The time interval between a) when the sensor reaches 10% of its full-scale value, and b) when it reaches 90% of its full-scale value.

Output Slew Rate (SR)

The rate of change [$\text{V}/\mu\text{s}$] in the output voltage from a) when the sensor reaches 10% of its full-scale value, and b) when it reaches 90% of its full-scale value.

Response Time, Propagation Delay, Rise Time, and Output Slew Rate (ACS732-5V)

Applied current step with 10%-90% rise time = $1 \mu\text{s}$

Test Conditions: $T_A = 25^\circ\text{C}$, $C_{\text{BYPASS}} = 0.1 \mu\text{F}$, $C_L = 0 \text{ F}$

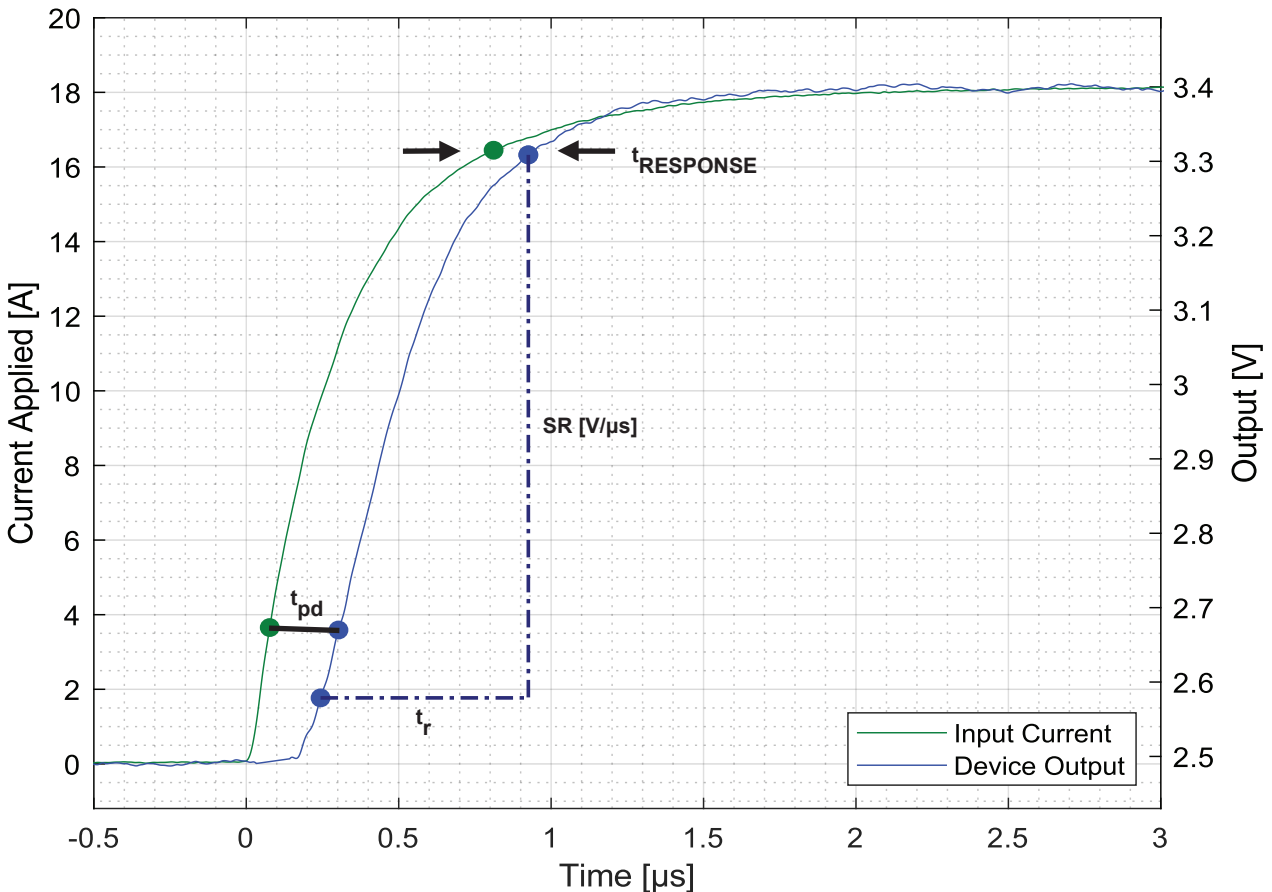

OVERCURRENT FAULT

Overcurrent Fault

The ACS732 and ACS733 have fast and accurate overcurrent fault detection circuitry. The overcurrent fault threshold (I_{FAULT}) is user-configurable via an external resistor divider and supports a range of 50% to 200% of the full-scale primary input ($I_{PR(MAX)}$). Fault response and the overcurrent fault thresholds are described in the following sections.

Fault Response

The high bandwidth of the ACS732 and ACS733 devices allow for extremely fast and accurate overcurrent fault detection. An overcurrent event occurs when the magnitude of the input current (I_P) exceeds the user-set threshold (I_{FAULT}). Fault response time ($t_{RESPONSE(F)}$) is defined from the time I_P goes above I_{FAULT} to the time the \overline{FAULT} pin goes below V_{FAULT} . Overcurrent fault response is illustrated in Figure 3. When I_P goes below $I_{FAULT} - I_{HYST}$, the \overline{FAULT} pin will be released. The rise time of V_{FAULT} will depend on the value of the resistor $R_{F(PULLUP)}$ and the capacitance on the pin.

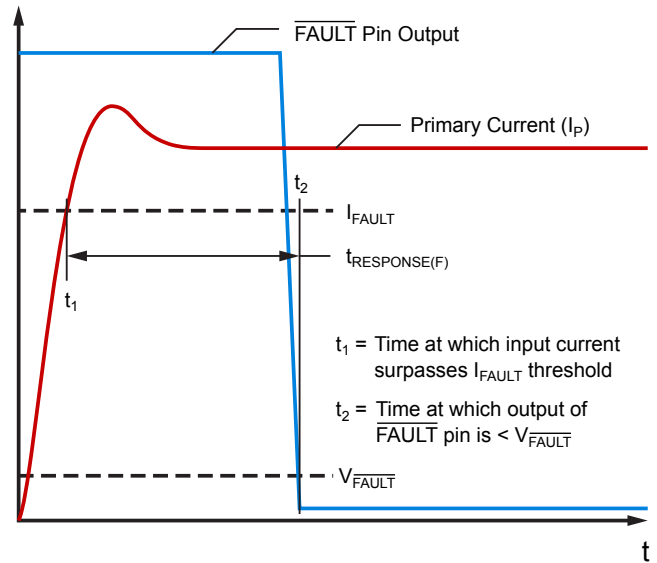

Figure 3: Overcurrent Fault Response

Setting the Overcurrent Fault Threshold

The overcurrent fault threshold (I_{FAULT}) is set via a resistor divider from V_{CC} to ground on the V_{OC} pin. The voltage on the V_{OC} pin, V_{VOC} , may range from $0.1 \times V_{CC}$ to $0.4 \times V_{CC}$. I_{FAULT} may be set anywhere from 50% to 200% $I_{PR(MAX)}$.

Overcurrent fault threshold versus V_{VOC} is shown in Figure 4.

The equation for calculating the trip current is shown below. For bidirectional devices, the fault will trip for both positive and negative currents.

$$I_{FAULT} = I_{PR(MAX)} \left\{ 5 \times \frac{V_{VOC}}{V_{CC}} \right\}$$

This may be rearranged to solve for the appropriate V_{VOC} value based on a desired over current fault threshold, shown by the equation:

$$V_{VOC} = \frac{V_{CC}}{5} \times \frac{I_{FAULT}}{I_{PR(MAX)}}$$

By setting V_{VOC} with a resistor divider from V_{CC} , the ratio of V_{VOC} / V_{CC} will remain constant with changes to V_{CC} . In this regard, the fault trip point will remain constant even as the supply voltage varies.

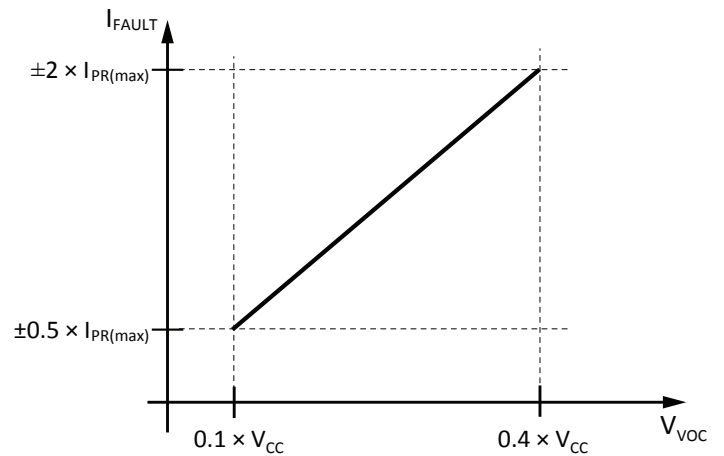

Figure 4: Fault Threshold vs. V_{VOC}

It is best practice to use resistor values $< 10 \text{ k}\Omega$ for setting V_{VOC} . With larger resistor values, the leakage current on V_{OC} may result in errors in the trip point.

DEFINITIONS OF ACCURACY CHARACTERISTICS

Sensitivity (Sens). The change in sensor IC output in response to a 1 A change through the primary conductor. The sensitivity is the product of the magnetic circuit sensitivity (G/A) (1 G = 0.1 mT) and the linear IC amplifier gain (mV/G). The linear IC amplifier gain is programmed at the factory to optimize the sensitivity (mV/A) for the full-scale current of the device.

Nonlinearity (E_{LIN}). The nonlinearity is a measure of how linear the output of the sensor IC is over the full current measurement range. The nonlinearity is calculated as:

$$E_{LIN} = \left\{ 1 - \left[\frac{V_{IOUT}(I_{PR(max)}) - V_{IOUT(Q)}}{2 \times V_{IOUT}(I_{PR(max)/2}) - V_{IOUT(Q)}} \right] \right\}$$

where $V_{IOUT}(I_{PR(max)})$ is the output of the sensor IC with the maximum measurement current flowing through it and $V_{IOUT}(I_{PR(max)/2})$ is the output of the sensor IC with half of the maximum measurement current flowing through it.

Zero Current Output Voltage ($V_{IOUT(Q)}$). The output of the sensor when the primary current is zero. For a unipolar supply voltage, it nominally remains at $0.5 \times V_{CC}$ for a bidirectional device and $0.1 \times V_{CC}$ for a unidirectional device. For example, in the case of a bidirectional output device, $V_{CC} = 3.3$ V translates into $V_{IOUT(Q)} = 1.65$ V. Variation in $V_{IOUT(Q)}$ can be attributed to the resolution of the Allegro linear IC quiescent voltage trim and thermal drift.

Voltage Offset Error (V_{OE}). The deviation of the device output from its ideal quiescent value of $0.5 \times V_{CC}$ (bidirectional) or $0.1 \times V_{CC}$ (unidirectional) due to nonmagnetic causes. To convert this voltage to amperes, divide by the device sensitivity, Sens.

Total Output Error (E_{TOT}). The difference between the current measurement from the sensor IC and the actual current (I_P), relative to the actual current. This is equivalent to the difference between the ideal output voltage and the actual output voltage, divided by the ideal sensitivity, relative to the current flowing through the primary conduction path:

$$E_{TOT}(I_P) = \frac{V_{IOUT_{ideal}}(I_P) - V_{IOUT}(I_P)}{Sens_{ideal}(I_P) \times I_P} \times 100 (\%)$$

The Total Output Error incorporates all sources of error and is a function of I_P . At relatively high currents, E_{TOT} will be mostly due to sensitivity error, and at relatively low currents, E_{TOT} will be mostly due to Voltage Offset Error (V_{OE}). As I_P approaches zero, E_{TOT} approaches infinity due to the offset voltage. This is illustrated in Figure 5 and Figure 6. Figure 5 shows a distribution of output voltages versus I_P at 25°C and across temperature. Figure 6 shows the corresponding E_{TOT} versus I_P .

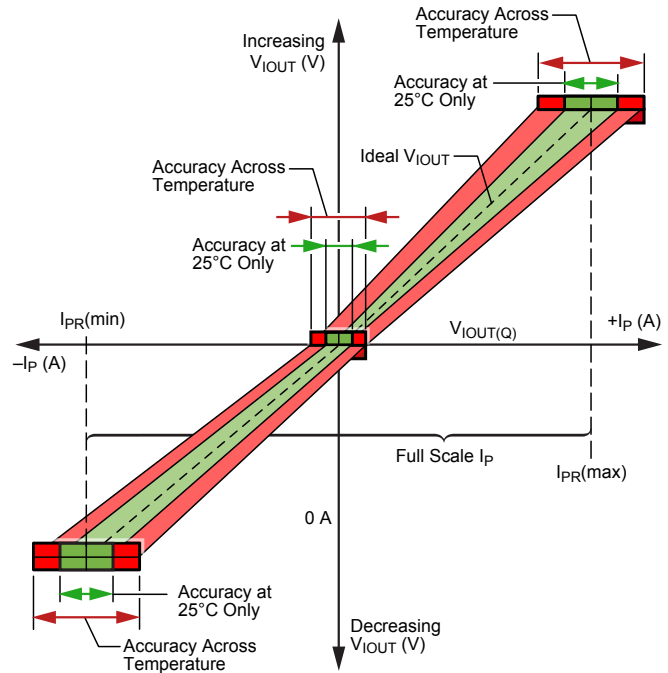

Figure 5: Output Voltage versus Sensed Current

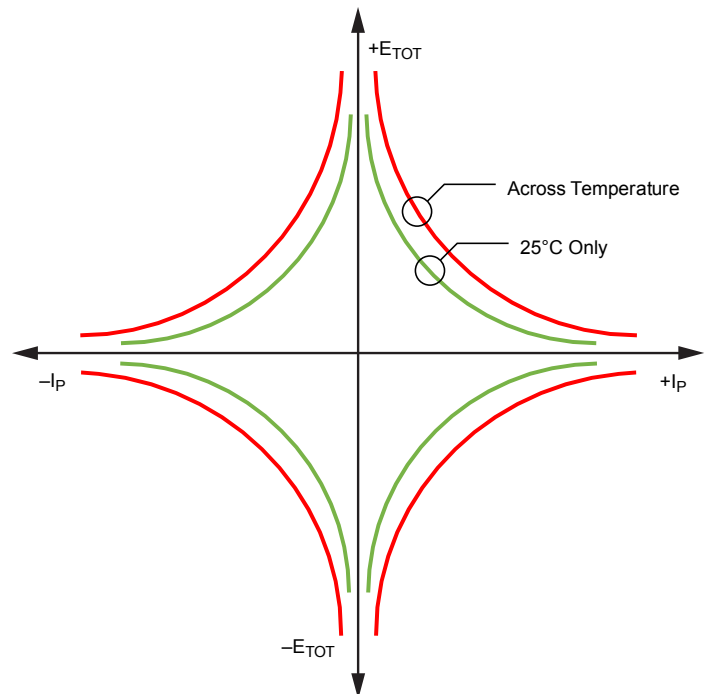

Figure 6: Total Output Error versus Sensed Current

APPLICATION INFORMATION

Ratiometry

The ACS732 and ACS733 are both ratiometric sensors. This means that for a given change in supply voltage, the device's zero current output voltage and sensitivity will scale proportionally.

Sensitivity Ratiometry

Ideally, a 5% increase in V_{CC} will result in a 5% increase in sensitivity. However, the ratiometric response of any sensor is not ideal. Ratiometric Sensitivity Error $E_{RAT(SENS)}$ is specified by the equation:

$$E_{RAT(SENS)} = 100\% \times \left(1 - \frac{Sensitivity_{V_{CC}}}{Sensitivity_{V_{CC(N)}}} \times \frac{V_{CC(N)}}{V_{CC}} \right)$$

where $V_{CC(N)}$ is equal to the nominal V_{CC} (3.3 V, or 5.0 V) and $Sensitivity_{V_{CC(N)}}$ is the measured sensitivity at nominal V_{CC} for a particular device. The symbol V_{CC} is the measured V_{CC} value in application and $Sensitivity_{V_{CC}}$ is the measured sensitivity at that V_{CC} level for a particular device.

Zero Current Offset Ratiometry

Ratiometric error for Zero Current Offset may be calculated using the following equation:

$$E_{RAT(Q)} = V_{IOUT(Q)V_{CC}} - V_{IOUT(Q)V_{CC(N)}} \times \frac{V_{CC}}{V_{CC(N)}}$$

Where $V_{CC(N)}$ is equal to the nominal V_{CC} (3.3 V, or 5.0 V) and $V_{IOUT(Q)V_{CC(N)}}$ is the measured Zero Current Offset voltage at nominal V_{CC} for a particular device. The symbol V_{CC} is the measured V_{CC} value in application and $V_{IOUT(Q)V_{CC}}$ is the measured zero current offset voltage for a particular device.

Estimating Total Error vs. Sensed Current

The performance characteristics tables give distribution (± 3 sigma) values for Total Error at $I_{PR(MAX)}$; however, one may be interested in the expected error at a particular current. This error may be estimated using the distribution data for the components of Total Error, Sensitivity Error, and Offset Voltage. The ± 3 sigma value for Total Error (E_{TOT}) as a function of the sensed current is estimated as:

$$E_{TOT}(I_p) = \sqrt{E_{SENS}^2 + \left(\frac{100 \times V_{OE}}{Sens \times I_p} \right)^2}$$

where E_{SENS} and V_{OE} are the ± 3 sigma values for those error terms.

If there is an average sensitivity error or average offset voltage, then the average Total Error is estimated as:

$$E_{TOTAVG}(I_p) = E_{SENSAVG} + \frac{100 \times V_{OEAVG}}{Sens \times I_p}$$

Layout Guidelines

There are a few considerations during PCB layout that will help to maintain high accuracy when using Allegro's integrated current sensors. Below is a list of common layout mistakes that should be avoided:

- Extending current carrying traces too far beneath the IC, or injecting current from the side of the IC
- Placing secondary current phase traces too close to or below the IC

Extending the Current Traces

The length of copper trace beneath the IC may impact the path of current flowing through the IP bus. This may cause variation in the coupling factor from the primary current loop of the package to the IC, and may reduce the overall creepage distance in application.

It is best practice for the current to approach the IC parallel to the current-carrying pins, and for the current-carrying trace to not creep towards the center of the package. Refer to Figure 7.

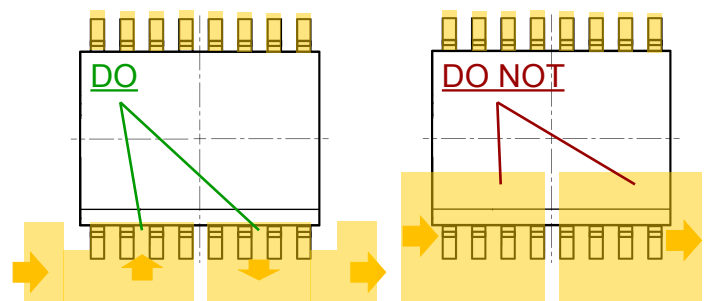

Figure 7: Best Practice Layout Techniques for Current Traces

If current must approach the package from the side, it is recommended to reduce the angle as much as possible. For more information on best current sensor layout practices refer to the application note “[Techniques to Minimize Common-Mode Field Interference When Using Allegro Current Sensor ICs](#)” on the Allegro website.

Thermal Rise vs. Primary Current

Self-heating due to the flow-off current should be considered during the design of any current sensing system. The sensor, printed circuit board (PCB), and contacts to the PCB will generate heat as current moves through the system.

The thermal response is highly dependent on PCB layout, copper thickness, cooling techniques, and the profile of the injected current. The current profile includes peak current, current “on-time”, and duty cycle. While the data presented in this section was collected with direct current (DC), these numbers may be used to approximate thermal response for both AC signals and current pulses.

The plot in Figure 8 shows the measured rise in steady-state die temperature of the ACS732/3 versus continuous current at an ambient temperature, T_A , of 25 °C. The thermal offset curves may be directly applied to other values of T_A . Conversely, Figure 9 shows the maximum continuous current at a given T_A . Surges beyond the maximum current listed in Figure 9 are allowed given the maximum junction temperature, $T_{J(MAX)}$ (165°C), is not exceeded.

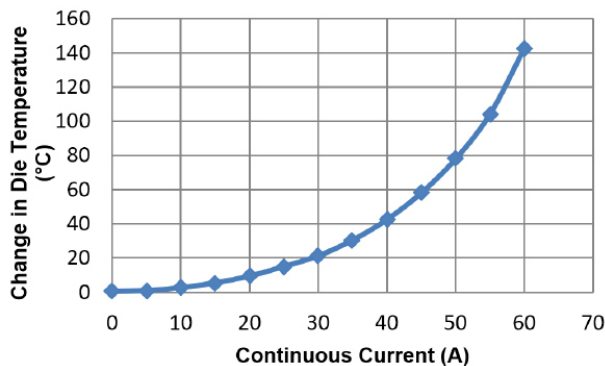

Figure 8: Self Heating in the LA Package Due to Current Flow

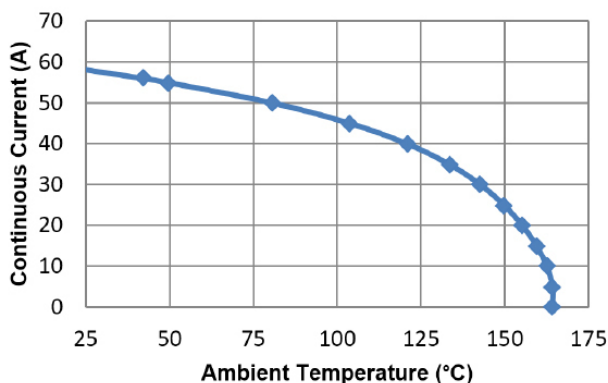

Figure 9: Maximum Continuous Current at a Given T_A

The thermal capacity of the ACS732/3 should be verified by the end user in the application’s specific conditions. The maximum junction temperature, $T_{J(MAX)}$ (165°C), should not be exceeded. Further information on this application testing is available in the [DC and Transient Current Capability application note](#) on the Allegro website.

ASEK73x Evaluation Board Layout

Thermal data shown in Figure 8 was collected using the ASEK73x Evaluation Board (TED-0001795). This board includes 1500 mm² of 2 oz. (0.0694 mm) copper connected to pins 1 through 4 and pins 5 through 8, with thermal vias connecting the layers. Top and bottom layers of the PCB are shown below in Figure 10.

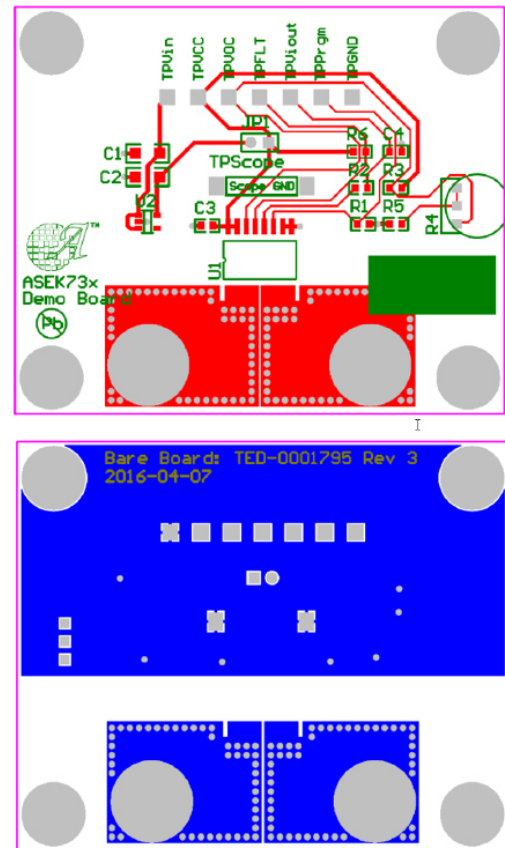

Figure 10: Top and Bottom Layers for ASEK73x Evaluation Board

Gerber files for the ASEK73x evaluation board are available for download from the Allegro website. See the technical documents section of the [ACS732 and ACS733 device webpage](#).

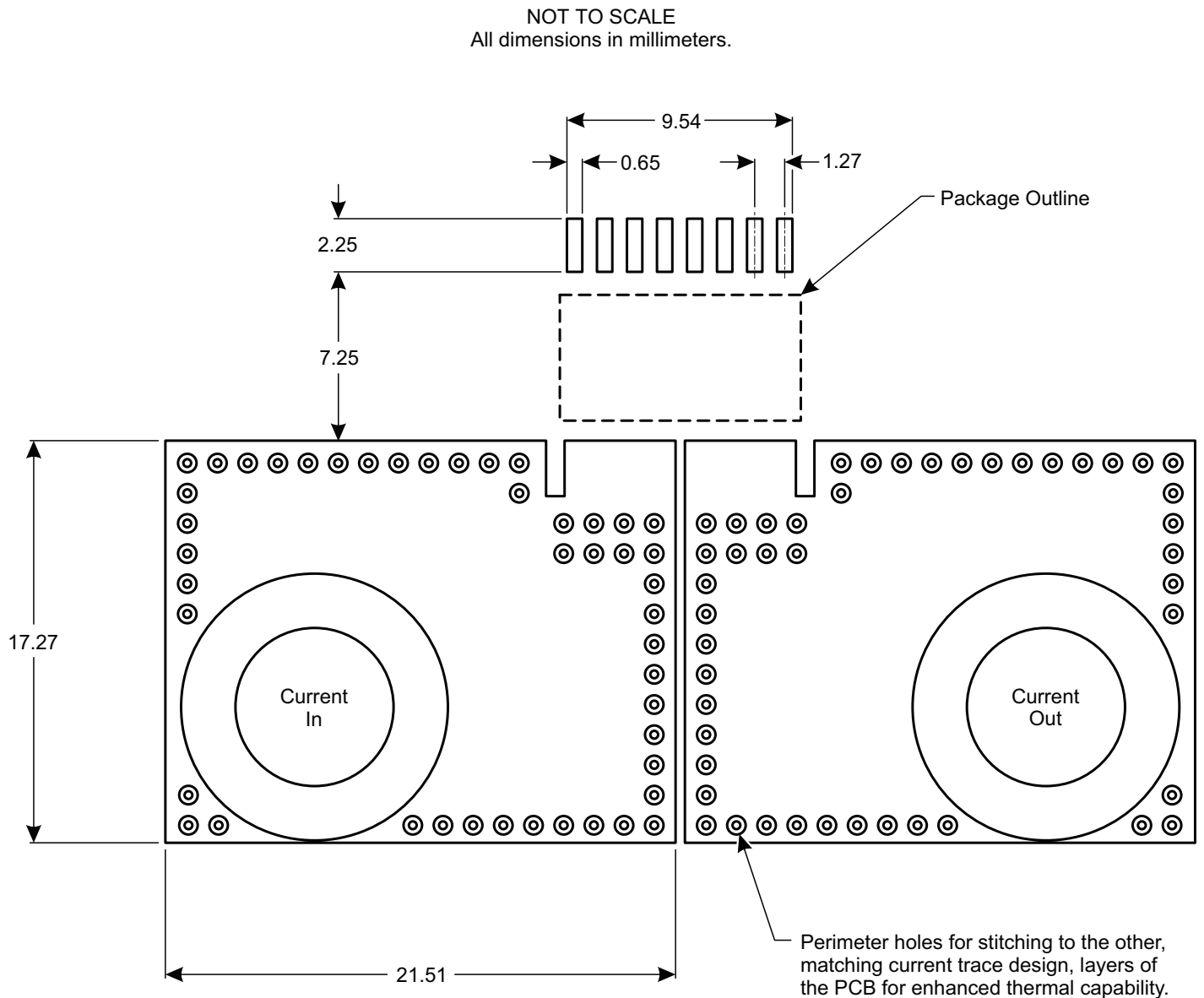

Figure 11: High-Isolation PCB Layout

PACKAGE OUTLINE DRAWING

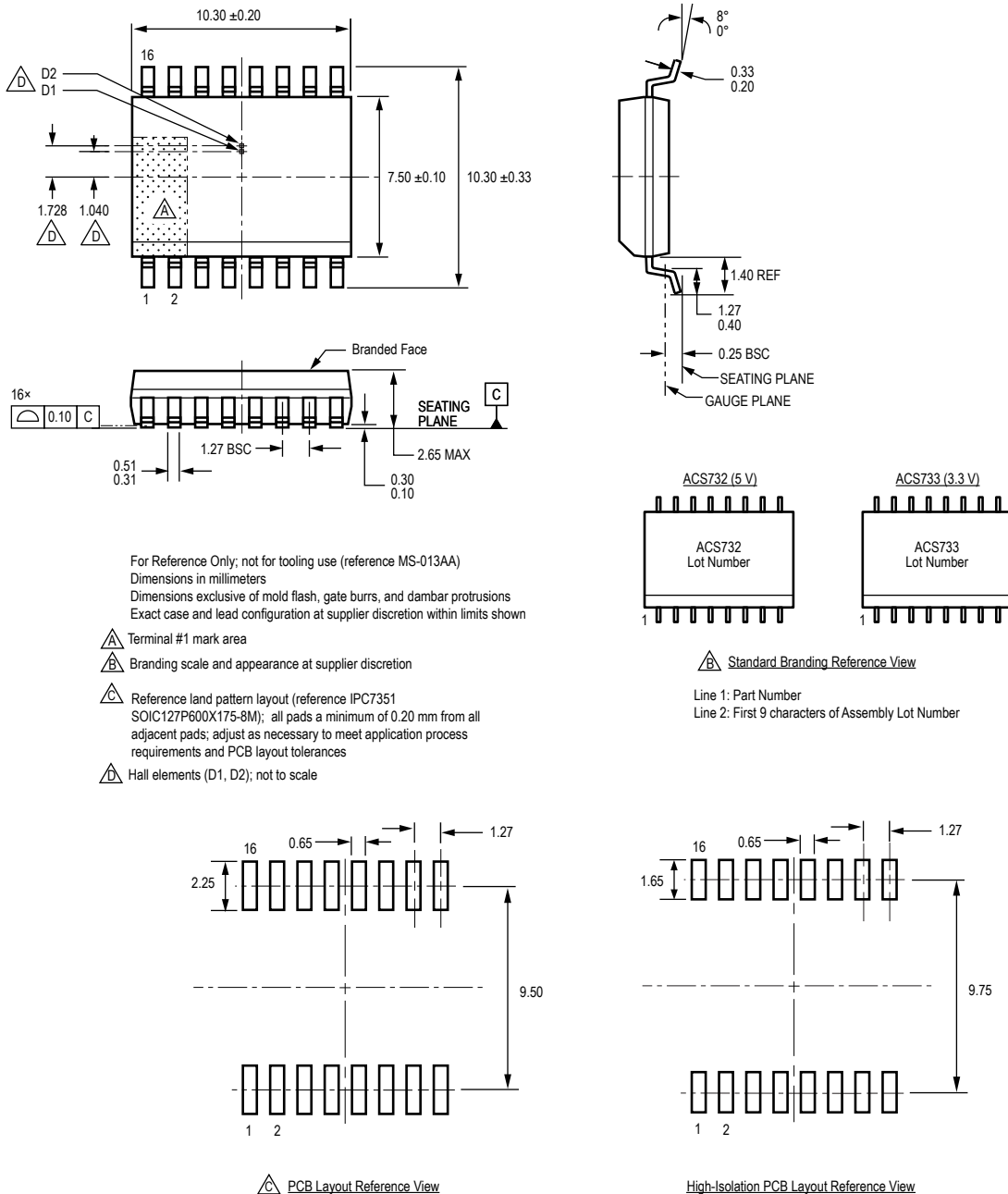

Figure 12: Package LA, 16-Pin SOICW

Revision History

Number	Date	Description
–	September 20, 2017	Initial release
1	January 8, 2018	Updated Rise Time, Response Time, and Propagation Delay Time (page 5)
2	March 8, 2018	Added ACS732KLATR-20AB-T part option
3	June 20, 2018	Updated Working Voltage for Basic Isolation units (page 4); added Fault Response Time and Fault Release Time characteristics (page 6)
4	July 2, 2018	Added “Thermal Rise vs. Primary Current” and “ASEK73x Evaluation Board Layout” to the Applications Information section (page 28)
5	October 1, 2018	Added ACS732KLATR-75AB-T variant (pages 2 and 9) Updated Secondary Hall Coupling Factor value (page 5)
6	November 13, 2018	Added ACS732KLATR-65AU-T part option (page 2 and 10) Added ACS732KLATR-75AB-T characteristic performance plots (page 18)
7	November 16, 2018	Added ACS732KLATR-65AB-T part option (page 2, 10, and 19)
8	December 10, 2018	Updated UL certificate number
9	February 26, 2019	Added Dielectric Surge Strength Test Voltage to Isolation Characteristics table (page 3)
10	May 23, 2019	Updated Sensitivity Error (pages 10-11) and Total Output Error (page 11)
11	August 22, 2019	Added Maximum Continuous Current to Absolute Maximum Ratings table (page 3), ESD ratings table (page 3), and updated thermal data section (page 34)
12	September 10, 2019	Added Hall plate dimensions (page 36)
13	September 26, 2019	Added Hall element positions to package outline drawings (page 36)
14	January 17, 2020	Corrected Reverse V_{OC} Voltage value (page 3); added Distance Through Insulation and Comparative Tracking Index to Isolation Characteristics table (page 3); updated Rise Time, Response Time, Propagation Delay, and Output Slew Rate test conditions, and added Output Slew Rate (page 6); removed Characteristic Performance plots (pages 17-24); updated Typical Frequency Response plots (page 17)
15	May 8, 2020	Removed Linearity Error from Common Electrical Characteristics table and added Linearity Error to Performance Characteristics Tables (pages 8-16); corrected Sensitivity Error test conditions (pages 8-16); corrected Lifetime Drift Characteristics numbers (pages 8-16); added ACS732KLATR-40AB-T multi-temperature characteristic performance plots (page 17); updated Typical Frequency Response plots (page 18); added Response Characteristics Definitions and Performance Data application page (page 19)
16	May 28, 2020	Updated Hall placement (p. 25)
17	June 9, 2020	Added ACS733KLATR-20AB-H part option (page 2, 14); updated Features and Benefits
18	June 29, 2020	Added minimum and maximum values to Linearity Error at $T_A = 25^\circ\text{C}$ (pages 8-17)
19	August 3, 2020	Corrected ACS732KLATR-40AB Total Output Error, Sensitivity Error, and Voltage Offset Error numbers; corrected ACS733KLATR-20AB and -20AB-H Total Output Error Including Lifetime Drift numbers
20	September 17, 2021	Updated Output Saturation Voltage $V_{SAT(LOW)}$ maximum values (page 6); added ACS733KLA-40AU-T characteristic performance plots (page 19)

Copyright 2021, Allegro MicroSystems.

Allegro MicroSystems reserves the right to make, from time to time, such departures from the detail specifications as may be required to permit improvements in the performance, reliability, or manufacturability of its products. Before placing an order, the user is cautioned to verify that the information being relied upon is current.

Allegro’s products are not to be used in any devices or systems, including but not limited to life support devices or systems, in which a failure of Allegro’s product can reasonably be expected to cause bodily harm.

The information included herein is believed to be accurate and reliable. However, Allegro MicroSystems assumes no responsibility for its use; nor for any infringement of patents or other rights of third parties which may result from its use.

Copies of this document are considered uncontrolled documents.

For the latest version of this document, visit our website:

www.allegromicro.com

X-ON Electronics

Largest Supplier of Electrical and Electronic Components

Click to view similar products for [Board Mount Current Sensors](#) category:

Click to view products by [Allegro](#) manufacturer:

Other Similar products are found below :

[CSDD1FR](#) [CSNP661-007](#) [S23P50100D15](#) [CSNE151-003](#) [ACS722LLCTR-05AB-T](#) [ACS733KLATR-40AB-T](#) [ACS71240LLCBTR-045B5](#)
[MT9523CT-20BF5](#) [TLI4971A120T5E0001XUMA1](#) [ACS724LLCTR-30AB-T](#) [ACS724LLCTR-05AB-T](#) [ACS724LLCTR-20AB-T](#)
[ACS724LLCTR-10AB-T](#) [MT9523CT-50BF5](#) [CH704100CT](#) [CC6921SO-20A](#) [CC6921BSO-20A](#) [TMCS1101A2UQDRQ1](#) [CI5930-20A](#)
[ACS733KLATR-20AB-T](#) [ACS758ECB-200B-PFF-T](#) [CI5931-30A](#) [MT9522WT-100BF5](#) [ACS758LCB-050B-PFF-T](#) [TMCS1101A4BQDRQ1](#)
[ACS758LCB-100B-PFF-T](#) [JSM6900SO-10A](#) [MT9522WT-65BF5](#) [ACS773LCB-100B-PFF-T](#) [TMCS1107A1BQDRQ1](#)
[TLE4971A025N5E0001XUMA1](#) [CH70110AB5PR](#) [ACS758KCB-150B-PFF-T](#) [HACS712ELCTR-20A-T](#) [HACS712ELCTR-05B-T](#)
[KTD1100-QNX](#) [LA25-NP/SP14](#) [LT308-S7](#) [hat500-s](#) [HAT1200-S](#) [ACS712ELCTR-30A-T\(XBLW\)](#) [ACS712ELCTR-05B-T\(XBLW\)](#)
[ACS712ELCTR-20A-T\(XBLW\)](#) [GZC6201AC020PK05](#) [HX712-20-S](#) [HX714-05-S](#) [HX714-20-S](#) [HX714-30-S](#) [HX724-05B-S](#) [HX724-30B-S](#)