

① HSS Cobalt Kegelsenker, unglei-  
che Teilung DIN 335 C, 90°

**Einsatzbereich:**

Für alle E- und NE-Metalle, Kunststoffe hart und weich. Universell einsetzbares Entgrat- und Senkwerkzeug für Bohrungen aller Art. Sehr gute Schneideigenschaften durch ungleichgeteilte Schneiden.



Hitzebeständig  
Heat resistant  
Termoestable



Präzise  
Precise  
Preciso



Industriequalität  
Industrial quality  
Calidad industrial

② HSS Cobalt countersinks, differ-  
ent partition DIN 335 C, 90°

**Range of application:**

For ferrous and non-ferrous metals, synthetic materials soft and hard. Universal deburring and sink tool for all kind of borings. Excellent cutting features guarantee a smooth surface by unequally divided cutting edges. Reduction of feed force and chatter marks on the countersinking surface due to reduced axial and radial force.

③ Avellanador cónico HSS Cobalto,  
división irregular, DIN 335 C, 90°

**Ámbito de aplicación:**

Para todos los metales E y NE y plásticos du-  
ros y blandos. Herramienta para desbarbar y  
avellanar de aplicación universal para agujeros  
de todo tipo. Excelentes características de  
corte, por corte desigual dividida.



Einzelverpackung mit Aufhänger  
Single pack with tag  
Embalaje individual con gancho para autoservicio



**ALUNIT®**  
Höhere Performance,  
längere Standzeit  
Higher performance,  
longer durability  
Rendimiento superior  
tiempo de uso más  
prolongado





Einzelverpackung mit Aufhänger  
Single pack with tag  
Embalaje individual con gancho para autoservicio

							blank / bright / brillante		ALUNIT®	
d1	d4		d2 <sub>h9</sub>	l1	Z	Code 2390	Inh.	Code 2397	Inh.	
mm	mm		mm	mm		Art.-Nr.	Cont.	Art.-Nr.	Cont.	
6,30	1,50	M 3	5,00	45	3	0239000630100	1	0239700630100	1	
8,30	2,00	M 4	6,00	50	3	0239000830100	1	0239700830100	1	
10,40	2,50	M 5	6,00	50	3	0239001040100	1	0239701040100	1	
12,40	2,80	M 6	8,00	56	3	0239001240100	1	0239701240100	1	
16,50	3,20	M 8	10,00	60	3	0239001650100	1	0239701650100	1	
20,50	3,50	M 10	10,00	63	3	0239002050100	1	0239702050100	1	
25,00	3,80	M 12	10,00	67	3	0239002500100	1	0239702500100	1	
31,00	4,20		12,00	71	3	0239003100100	1	0239703100100	1	

Ⓛ Kassetten, Sets

Ⓔ Cassettes, sets

Ⓔ Cajas, juegos

<p>HSS Cobalt Kegelsenker-Satz KM 4</p>  <p>4-tlg. / 4-pcs. / 4-unid. Metallkassette / Metal cassette / Caja de metal Art.-Nr. 023900004100</p>		<p>HSS Cobalt Kegelsenker-Satz KP 5</p>  <p>5-tlg. / 5-pcs. / 5-unid. Kunststoffkassette / Plastic cassette / Caja de plástico Art.-Nr. 023900005100</p>		<p>HSS Cobalt Kegelsenker-Satz KM 4</p>  <p>4-tlg. / 4-pcs. / 4-unid. Metallkassette / Metal cassette / Caja de metal Art.-Nr. 023970004100</p>	
Ø mm	Stk. <sup>(1)</sup> pc. <sup>(1)</sup>	Ø mm	Stk. <sup>(1)</sup> pc. <sup>(1)</sup>	Ø mm	Stk. <sup>(1)</sup> pc. <sup>(1)</sup>
MAYKESTAG		MAYKESTAG		MAYKESTAG	
Ø 10,40 / 16,50 / 20,50 / 25,00	1	Ø 6,30 / 10,40 / 16,50 / 20,50 / 25,00	1	Ø 10,40 / 16,50 / 20,50 / 25,00	1
<p>HSS Cobalt Kegelsenker-Satz KP 5</p>  <p>5-tlg. / 5-pcs. / 5-unid. Kunststoffkassette / Plastic cassette / Caja de plástico Art.-Nr. 023970005100</p>		<p>Hartmetall-Set Frässtifte/Senker BOX 5</p>  <p>5-tlg. / 5-pcs. / 5-unid. Kunststoffbox / Plastic box / Caja de plástico Art.-Nr. 077600002100</p>			
Ø mm	Stk. <sup>(1)</sup> pc. <sup>(1)</sup>	Ø mm	Stk. <sup>(1)</sup> pc. <sup>(1)</sup>		
MAYKESTAG		HM-Frässtift			
Ø 6,30 / 10,40 / 16,50 / 20,50 / 25,00	1	Ø 10x65, ZYA-S	1		
		Ø 10x65, WRC	1		
		Ø 10x65, SPG	1		
		MAYKESTAG			
		HSS Cobalt Kegelsenker Ø 10,40 / 12,40	1		



Gewinde-, Senk- und Schälwerkzeuge  
Taps, dies, countersinks and conecut  
herramientas para roscar, avellanar y escarpar

<sup>(1)</sup> Stück je Abmessung / Pieces each dimension / Piezas por diámetro

**D HSS Cobalt Kegelsenker,  
3-Flächenschaft, ungleiche  
Teilung, DIN 335 C, 90°**

**Einsatzbereich:**

Für alle E- und NE-Metalle, Kunststoffe hart und weich. Universell einsetzbares Entgrat- und Senkwerkzeug für Bohrungen aller Art. Sehr gute Schneideigenschaften durch ungleichgeteilte Schneiden.



Hitzebeständig  
Heat resistant  
Termoestable



Präzise  
Precise  
Preciso



3-Flächenschaft  
3-surface shank  
3 caras

**E HSS Cobalt countersinks,  
3-surface shank, different parti-  
tion, DIN 335 C, 90°**

**Range of application:**

For ferrous and non-ferrous metals, synthetic materials soft and hard. Universal deburring and sink tool for all kind of borings. Excellent cutting features guarantee a smooth surface by unequally divided cutting edges.

**E5 Avellanador cónico HSS Cobalto,  
eje de 3 caras, división irregular,  
DIN 335 C, 90°**

**Ámbito de aplicación:**

Para todos los metales E y NE y plásticos duros y blandos. Herramienta para desbarbar y avellanar de aplicación universal para agujeros de todo tipo. Excelentes características de corte, por corte desigual dividida.

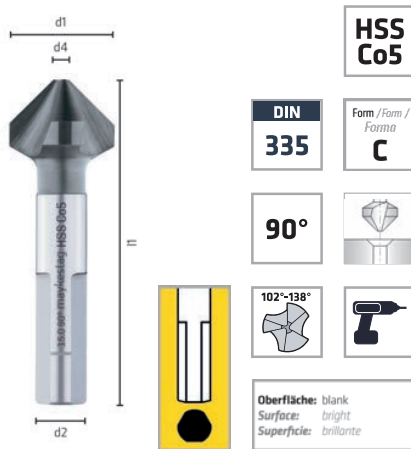

Einzelverpackung mit Aufhänger  
Single pack with tag  
Embalaje individual con gancho para autoservicio



**ALUNIT®**  
Höhere Performance,  
längere Standzeit  
Higher performance,  
longer durability  
Rendimiento superior  
tiempo de uso más  
prolongado





Einzelverpackung mit Aufhänger  
Single pack with tag  
Embalaje individual con gancho para autoservicio

							blank / bright / brillante		ALUNIT®	
d1	d4		d2 <sub>h9</sub>	l1	Z	Code 2380	Inh.	Code 2387	Inh.	
mm	mm		mm	mm		Art.-Nr.	Cont.	Art.-Nr.	Cont.	
6,30	1,50	M 3	5,00	45	3	0238000630100	1	0238700630100	1	
8,30	2,00	M 4	6,00	50	3	0238000830100	1	0238700830100	1	
10,40	2,50	M 5	6,00	50	3	0238001040100	1	0238701040100	1	
12,40	2,80	M 6	8,00	56	3	0238001240100	1	0238701240100	1	
16,50	3,20	M 8	10,00	60	3	0238001650100	1	0238701650100	1	
20,50	3,50	M 10	10,00	63	3	0238002050100	1	0238702050100	1	
25,00	3,80	M 12	10,00	67	3	0238002500100	1	0238702500100	1	
31,00	4,20		12,00	71	3	0238003100100	1	0238703100100	1	

🇩🇪 Kassetten, Sets

🇪🇸 Cassettes, sets

🇪🇸 Cajas, juegos

<p>HSS Cobalt Kegelsenker-Satz KM 4</p>  <p>4-tlg. / 4-pcs. / 4-unid. Metallkassette / Metal cassette / Caja de metal Art.-Nr. 023800004100</p>		<p>HSS Cobalt Kegelsenker-Satz KP 5</p>  <p>5-tlg. / 5-pcs. / 5-unid. Kunststoffkassette / Plastic cassette / Caja de plástico Art.-Nr. 023800005100</p>		<p>HSS Cobalt Kegelsenker-Satz KM 4</p>  <p>4-tlg. / 4-pcs. / 4-unid. Metallkassette / Metal cassette / Caja de metal Art.-Nr. 0238700004100</p>	
Ø mm	Stk. <sup>(1)</sup> pc. <sup>(1)</sup>	Ø mm	Stk. <sup>(1)</sup> pc. <sup>(1)</sup>	Ø mm	Stk. <sup>(1)</sup> pc. <sup>(1)</sup>
MAYKESTAG		MAYKESTAG		MAYKESTAG	
Ø 10,40 / 16,50 / 20,50 / 25,00	1	Ø 6,30 / 10,40 / 16,50 / 20,50 / 25,00	1	Ø 10,40 / 16,50 / 20,50 / 25,00	1
<p>HSS Cobalt Kegelsenker-Satz KP 5</p>  <p>5-tlg. / 5-pcs. / 5-unid. Kunststoffkassette / Plastic cassette / Caja de plástico Art.-Nr. 0238700005100</p>					
Ø mm	Stk. <sup>(1)</sup> pc. <sup>(1)</sup>				
MAYKESTAG					
Ø 6,30 / 10,40 / 16,50 / 20,50 / 25,00	1				



Gewinde-, Senk- und Schälwerkzeuge  
Taps, dies, countersinks and conecut  
herramientas para roscar, avellanar y escarpar

<sup>(1)</sup> Stück je Abmessung / Pieces each dimension / Piezas por diámetro

## HSS Cobalt Kegelsenker lang, ungleiche Teilung DIN 335 C, 90°

### Einsatzbereich:

Für alle E- und NE-Metalle, Kunststoffe hart und weich. Universell einsetzbares Entgrat- und Senkwerkzeug für Bohrungen aller Art. Sehr gute Schneideigenschaften durch ungleichgeteilte Schneiden.



Hitzebeständig  
Heat resistant  
Termoestable



Präzise  
Precise  
Preciso



Industriequalität  
Industrial quality  
Calidad industrial

## E HSS Cobalt countersinks long series, different partition DIN 335 C, 90°

### Range of application:

For ferrous and non-ferrous metals, synthetic materials soft and hard. Universal deburring and sink tool for all kind of borings. Excellent cutting features guarantee a smooth surface by unequally divided cutting edges. Reduction of feed force and chatter marks on the countersinking surface due to reduced axial and radial force.

## ES Avellanador cónico HSS Cobalto, larga, división irregular, DIN 335 C, 90°

### Ámbito de aplicación:

Para todos los metales E y NE y plásticos duros y blandos. Herramienta para desbarbar y avellanar de aplicación universal para agujeros de todo tipo. Excelentes características de corte, por corte desigual dividida.

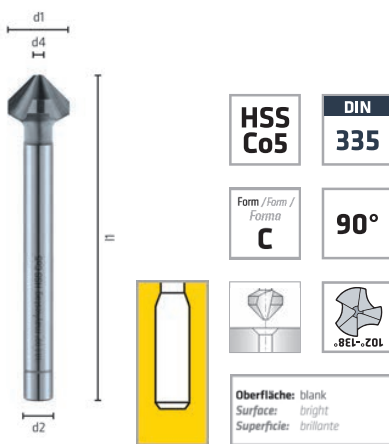

Einzelverpackung mit Aufhänger  
Single pack with tag  
Embalaje individual con gancho para autoservicio



**ALUNIT®**  
Höhere Performance,  
längere Standzeit  
Higher performance,  
longer durability  
Rendimiento superior  
tiempo de uso más  
prolongado





Einzelverpackung mit Aufhänger  
Single pack with tag  
Embalaje individual con gancho para autoservicio

							blank / bright / brillante		ALUNIT®	
d1	d4		d2 <sub>h9</sub>	l1	Z	Code 2340	Inh.	Code 2347	Inh.	
mm	mm		mm	mm		Art.-Nr.	Cont.	Art.-Nr.	Cont.	
6,30	1,50	M3	5,00	104	3	0234000630100	1	0234700630100	1	
8,30	2,00	M4	6,00	105	3	0234000830100	1	0234700830100	1	
10,40	2,50	M5	6,00	107	3	0234001040100	1	0234701040100	1	
12,40	2,80	M6	8,00	108	3	0234001240100	1	0234701240100	1	
16,50	3,20	M8	10,00	111	3	0234001650100	1	0234701650100	1	
20,50	3,50	M10	10,00	114	3	0234002050100	1	0234702050100	1	
25,00	3,80	M12	10,00	118	3	0234002500100	1	0234702500100	1	
31,00	4,20	M16	12,00	140	3	0234003100100	1	0234703100100	1	

Ⓛ Kassetten, Sets

Ⓔ Cassettes, sets

Ⓔ Cajas, juegos

<p>HSS Co5 Kegelsenker-Satz, 6-tlg.</p>   <p>6-tlg. / 6-pcs. / 6-unid. Kunststoffkassette / Plastic cassette / Caja de plástico Art.-Nr. 0234000006100</p>		<p>HSS Co5 Kegelsenker-Satz, 6-tlg.</p>   <p>6-tlg. / 6-pcs. / 6-unid. Kunststoffkassette / Plastic cassette / Caja de plástico Art.-Nr. 0234700006100</p>	
Ø mm	Stk. <sup>(1)</sup> pc. <sup>(1)</sup>	Ø mm	Stk. <sup>(1)</sup> pc. <sup>(1)</sup>
MAYKESTAG		MAYKESTAG	
Ø 6,3 / 8,3 / 10,4 / 12,4 / 16,5 / 20,5	1	Ø 6,3 / 8,3 / 10,4 / 12,4 / 16,5 / 20,5	1



Gewinde-, Senk- und Schälwerkzeuge  
Taps, dies, countersinks and conecut  
herramientas para roscar, avellanar y escarpar

<sup>(1)</sup> Stück je Abmessung / Pieces each dimension / Piezas por diámetro

**D HSS Cobalt Kegelsenker,  
DIN 335 C, 90°**

**Einsatzbereich:**

Für alle E- und NE-Metalle, Kunststoffe hart und weich. Universell einsetzbares Entgrat- und Senkwerkzeug für Bohrungen aller Art. Sehr gute Schneideigenschaften ohne "Rat-termarken", durch radialen Hinterschliff leicht nachschärfbar an der Spanfläche.



Hitzebeständig  
Heat resistant  
Termoestable



Präzise  
Precise  
Preciso



Industriequalität  
Industrial quality  
Calidad industrial

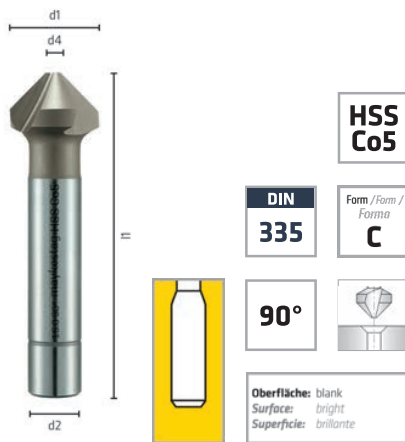

**E HSS Cobalt countersinks,  
DIN 335 C, 90°**

**Range of application:**

For ferrous and non-ferrous metals, synthetic materials soft and hard. Universal deburring and sink tool for all kind of borings. Excellent cutting features guarantee a smooth surface without burrs; profile relief facilitates an easy regrind.

**ES Avellanador cónico HSS Cobalto,  
DIN 335 C, 90°**

**Ámbito de aplicación:**

Para todos los metales E y NE y plásticos duros y blandos. Herramienta para desbarbar y avellanar de aplicación universal para agujeros de todo tipo. Excelentes características de corte sin "rayado transversal", fácil reafilado de la superficie de deslizamiento gracias al talón radial.



Einzelverpackung mit Aufhänger  
Single pack with tag  
Embalaje individual con gancho para autoservicio



**ALUNIT®**  
Höhere Performance,  
längere Standzeit  
Higher performance,  
longer durability  
Rendimiento superior  
tiempo de uso más  
prolongado







Einzelverpackung mit Aufhänger  
Single pack with tag  
Embalaje individual con gancho para autoservicio

							blank / bright / brillante		ALUNIT®	
d1	d4		d2 <sub>hg</sub>	l1	Z	Code 2290	Inh.	Code 2297	Inh.	
mm	mm		mm	mm		Art.-Nr.	Cont.	Art.-Nr.	Cont.	
4,30	1,30	M 2	4,00	40	3	0229000430100	1			
5,00	1,50		4,00	40	3	0229000500100	1	0229700500100	1	
5,30	1,50		4,00	40	3	0229000530100	1			
6,00	1,50		5,00	45	3	0229000600100	1	0229700600100	1	
6,30	1,50	M 3	5,00	45	3	0229000630100	1	0229700630100	1	
8,00	2,00		6,00	50	3	0229000800100	1	0229700800100	1	
8,30	2,00	M 4	6,00	50	3	0229000830100	1	0229700830100	1	
9,40	2,20		6,00	50	3	0229000940100	1			
10,00	2,50		6,00	50	3	0229001000100	1	0229701000100	1	
10,40	2,50	M 5	6,00	50	3	0229001040100	1	0229701040100	1	
11,50	2,80		8,00	56	3	0229001150100	1			
12,40	2,80	M 6	8,00	56	3	0229001240100	1	0229701240100	1	
13,40	2,90		8,00	56	3	0229001340100	1			
15,00	3,20		10,00	60	3	0229001500100	1	0229701500100	1	
16,50	3,20	M 8	10,00	60	3	0229001650100	1	0229701650100	1	
19,00	3,50		10,00	63	3	0229001900100	1	0229701900100	1	
20,50	3,50	M 10	10,00	63	3	0229002050100	1	0229702050100	1	
23,00	3,80		10,00	67	3	0229002300100	1			
25,00	3,80	M 12	10,00	67	3	0229002500100	1	0229702500100	1	
31,00	4,20		12,00	71	3	0229003100100	1	0229703100100	1	

🇩🇪 Kassetten, Sets

🇪🇸 Cassettes, sets

🇪🇸 Cajas, juegos

HSS Cobalt Kegelsenker-Satz KM 4		HSS Cobalt Kegelsenker-Satz KM 6		HSS Cobalt Kegelsenker-Satz KM 4	
 		 		 	
4-tlg. / 4-pcs. / 4-unid. Metallkassette / Metal cassette / Caja de metal Art.-Nr. 0229000004100		6-tlg. / 6-pcs. / 6-unid. Metallkassette / Metal cassette / Caja de metal Art.-Nr. 0229000096100		4-tlg. / 4-pcs. / 4-unid. Metallkassette / Metal cassette / Caja de metal Art.-Nr. 0229700004100	
Ø mm	Stk. <sup>(1)</sup> pc. <sup>(1)</sup>	Ø mm	Stk. <sup>(1)</sup> pc. <sup>(1)</sup>	Ø mm	Stk. <sup>(1)</sup> pc. <sup>(1)</sup>
MAYKESTAG		MAYKESTAG		MAYKESTAG	
Ø 10,40 / 16,50 / 20,50 / 25,00	1	Ø 6,30 / 8,30 / 10,40 / 12,40 / 16,50 / 20,50	1	Ø 10,40 / 16,50 / 20,50 / 25,00	1



Gewinde-, Senk- und Schälwerkzeuge  
 Taps, dies, countersinks and conecut  
 herramientas para roscar, avellanar y escarpar

<sup>(1)</sup> Stück je Abmessung / Pieces each dimension / Piezas por diámetro



## X-ON Electronics

Largest Supplier of Electrical and Electronic Components

*Click to view similar products for [Other Tools](#) category:*

*Click to view products by [Alpen-Maykestag](#) manufacturer:*

Other Similar products are found below :

[899-2-KT46](#) [CR-0AFL4--332K](#) [568681-1](#) [5800-0090](#) [58061-1](#) [59085](#) [00-8273-RDPP](#) [593033](#) [593072](#) [593564100](#) [593575](#) [593593](#) [010-0003-0000](#) [011349-000](#) [CRCW08052740FRT1](#) [LUC-012S070DSM](#) [LUC-018S070DSP](#) [LUC-024S105DSP](#) [599-2021-3-NME](#) [599-JJ-2021-03](#) [CRCW2010331JR02](#) [601-JJ-06](#) [601-SPB](#) [601YSY](#) [602-JJ-03](#) [602SPB](#) [603-JJ-07-FP](#) [603-JJY-04](#) [CRTN1013](#) [CS16](#) [6-1579014-0](#) [62036240-1](#) [M43435 TY 1 SZ 3 FIN B BLK](#) [M43435 TY 2 SZ 3 FIN C BLK](#) [M43435 TY 5 SZ 3 FIN C NAT](#) [M-5Z](#) [M6816](#) [660-29ABT1](#) [662508-1](#) [CVHD-950X-93.333](#) [CW104-01X](#) [671-GP-04-KT39-73207](#) [CW307-01A](#) [CW30901A](#) [CW6211201A](#) [690191-1](#) [690191-3](#) [690317-2](#) [691409-4](#)