

# THE EXPERTS IN DRILLING.

// 2022 | 2023



*drill better.*  
**alpen**

**D** Inhaltsverzeichnis

**E** Table of contents

**ES** Resumen

Code	Seite / Page / Pàgina	Code	Seite / Page / Pàgina	Code	Seite / Page / Pàgina	Code	Seite / Page / Pàgina
055	208	509	34	727	68	897	94
056	210	517	74	728	303	898	94
065	209	519	34	729	32	899	94
066	210	528	173	730	32	901	114
075	209	529	35	734	126	902	278
100	174	539	35	737	68	904	119
101	174	551	173	762	79	905	81
111	176	579	35	763	79	906	119
117	73	580	93	764	80	907	114
118	73	601	145	765	80	913	89
121	177	607	135	768	85	914	89
123	178	611	131	769	86	915	82
124	178	613	135	770	86	921	114
125	179	616	200	771	87	951	157
126	179	617	75	773	87	952	155
127	179	618	162	777	234	954	152
130	180	620	197	778	236	970	104
172	31	622	198	778	88	971	104
181	157	623	135	779	238	973	103
183	131	626	162	780	240	974	104
184	152	631	162	781	242	978	104
188	67	633	194	783	244	979	104
189	69	638	143	784	246	980	96
202	181	640	166	785	248	981	96
216	202	642	166	786	250	982	96
226	203	648	166	787	252	983	96
228	203	654	166	788	254	984	96
234	212	655	140	789	256	985	96
235	207	656	140	790	258	987	95
236	206	663	127	805	79	996	106
237	211	680	41	807	85	2270	287
238	212	701	278	815	79	2290	294
239	205	702	285	817	86	2291	301
252	43	703	286	825	80	2292	299
253	43	704	281	827	86	2297	294
257	45	706	276	835	80	2320	297
258	46	707	275	837	87	2340	292
272	33	708	277	845	80	2347	292
289	54	709	283	847	87	2380	290
290	53	710	279	871	101	2387	290
297	52	711	280	872	101	2390	288
300	50	712	278	875	81	2397	288
301	125	713	278	877	88	5430	278
303	48	714	282	885	102	6146	225
311	124	717	274	886	102	6147	225
321	122	718	74	887	88	6156	228
327	74	719	284	888	102	6157	228
330	180	720	302	889	98	6405	233
331	123	721	305	890	98	6407	233
336	180	721	307	891	99	6530	232
352	39	722	303	892	99	6637	232
367	74	723	305	893	99		
371	123	725	305	894	99		
501	170	726	303	895	99		

**Spezialbohrer**  
*Special drill bits*  
*Brocas especiales*

> Seite / Page / Página 27



**Gesteinsbohrer, SDS-Bohrer und Meißel**  
*Concrete and Masonry drill bits, SDS hammer drill bits and chisels*  
*Broca para piedra, broca de percusión SDS y cinceles*

> Seite / Page / Página 61



**Metall- und Edelstahlbohrer**  
*Metal drills and stainless steel drills*  
*Broca para metal y broca de acero inoxidable*

> Seite / Page / Página 109



**Holzbohrer**  
*Drills for wood*  
*Brocas para madera*

> Seite / Page / Página 191



**Hartmetall Werkzeuge**  
*Tungsten carbide tools*  
*Herramientas de metal duro*

> Seite / Page / Página 219



**Gewinde-, Senk- und Schälwerkzeuge**  
*Taps, dies, countersinks and conecut*  
*Herramientas para roscar, avellanar y escarpar*

> Seite / Page / Página 269





**NEW**

**PROTECTOR**

★★★★★

- ⓓ Feinsteinzeug-Fliesenbohrer
- Ⓔ Porcelain / gres tile drill bit
- Ⓔ Broca para baldosas de gres porcelánico

// Seite / page / página 48



Für das perfekte Bohrloch in den härtesten Feinsteinzeugfliesen.  
For the perfect hole in the hardest porcelain tiles.  
Para el agujero perfecto hasta en las baldosas de gres más resistentes.

**max. 600 min<sup>-1</sup>**

**HSS PZ-COBALT GRIP**

★★★★★

- ⓓ HSS Cobalt Spiralbohrer, 3-Flächenschaft, extra kurz, DIN 1897 PZ
- Ⓔ HSS Cobalt stub drills, 3-surface shank, DIN 1897 PZ
- Ⓔ Broca espiral HSS Cobalt, eje de 3 cantos, extra corta, DIN 1897 PZ

// Seite / page / página 119



**NEW**

**HSS COBALT GRIP**

★★★★★

- ⓓ HSS Cobalt Spiralbohrer, 3-Flächenschaft, kurz, DIN 338 RN
- Ⓔ HSS Cobalt jobber drills, 3-surface shank, DIN 338 RN
- Ⓔ Broca espiral HSS Cobalt, eje de 3 cantos, corta, DIN 338 RN

// Seite / page / página 140

**NEW**

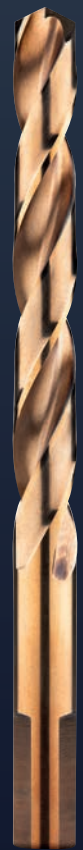

Der 3-Flächenschaft verhindert das Durchdrehen im Bohrfutter  
The 3-surface shank prevents slipping in the chuck  
El nuevo vástago antideslizante evita la rotación en el portabrocas



## SDS MAX



① Stockermeißel

② *Bushing chisel*

③ *Cinzel dentado*

// Seite / page / página 104



Zum Aufrauen von Oberflächen und zur Entfernung von Betonüberständen.  
For roughening surfaces and removing excess concrete.  
Para legrar superficies y eliminar restos de hormigón.

## HSS COBALT



① HSS Cobalt Kegelsenker, ungleiche Teilung,

② *HSS Cobalt countersinks, different partition,*

③ *Avellanador cónico HSS Cobalto, división irregular,*

DIN 334 C, 60°

// Seite / page / página 287



NEW

Standard Kegelsenker  
Standard countersink  
Avellanador cónico estándar

mit ungleicher Teilung  
with different partition  
con división irregular



DIN 335 C, 90°

// Seite / page / página 292



NEW



NEW

## VIELFÄLTIGES KASSETTEN-SORTIMENT

② *NUMEROUS CASSETTE-OPTIONS*

③ *GRAN VARIEDAD DE CAJAS*

Wir bieten unseren Kunden ein breites Angebot an Set- und Kassettenlösungen, um den unterschiedlichsten Bedürfnissen zu entsprechen.

*We offer a broad selection of sets and cassette options to cover our customers' varying requirements.*

*Asimismo, ofrecemos a nuestros clientes una amplia oferta de juegos y cajas para satisfacer las necesidades más variadas.*



# DER **BOHREXPORTE** FÜR PROFIS

*Wir stehen für Qualität- Innovation - Zuverlässigkeit.*

// Als führender Hersteller von Metall-, Stein- und Holzbohrern und als Europas einziger Komplettanbieter für Bohrwerkzeuge aus eigener Fertigung produzieren wir jährlich mehr als 35 Millionen professionelle und innovative Produkte für unsere Kunden. Unsere österreichischen Produktionsstandorte bedienen Profis weltweit - in über 70 Ländern. Auf Basis von mehr als 60 Jahren Erfahrung als Familienunternehmen und herausragenden Alleinstellungsmerkmalen sind wir überzeugt, das perfekte Werkzeug für jede Herausforderung zu bieten. Mithilfe intelligenter Technik setzen wir alles daran, die hohe Qualität noch weiter auszubauen und somit den Markt von morgen mitzugestalten.





**E THE DRILL EXPERTS FOR PROFESSIONALS**

***We stand for quality – innovation – reliability.***

*As a leading manufacturer of drill bits for metal, masonry and wood and as Europe's only comprehensive provider of drilling tools from proprietary production, we produce more than 35 million professional and innovative products for our customers every year. Our Austrian production sites serve professionals worldwide - in over 70 countries. Based on more than 60 years of experience as a family-owned company and outstanding unique selling propositions, we are convinced to offer the perfect tool for every challenge. With the help of intelligent technology, we are doing everything we can to expand our high quality even further and thus help shape the market of tomorrow.*

**ES EL EXPERTO EN TALADROS PARA PROFESIONALES.**

***Somos una empresa de calidad, innovación y fiabilidad.***

*Como fabricante líder de brocas para metal, piedra y madera, y como único proveedor europeo de herramientas de perforación de producción propia, producimos cada año más de 35 millones de productos profesionales e innovadores para nuestros clientes. Nuestros centros de producción austríacos sirven a profesionales de todo el mundo, en más de 70 países. Gracias a nuestros más de 60 años de experiencia como empresa familiar y a nuestras extraordinarias propuestas de venta, estamos convencidos de que ofrecemos la herramienta perfecta para cada reto. Con la ayuda de la tecnología inteligente, hacemos todo lo posible para seguir ampliando nuestra alta calidad y contribuir así a dar forma al mercado del mañana.*

# UNSERE VIELSEITIGKEIT IST IHR GEWINN.

// Mit unserem Sortiment an über 4000 Standard- und Spezialbohrern garantieren wir Ihnen das perfekte Werkzeug für jede Anforderung. Egal wo Sie arbeiten - mit uns bohren Sie schneller, einfacher und wirtschaftlicher. Dabei überzeugen wir durch Qualität, kurze Bohrzeiten und hohe Standzeiten auch unter härtesten Bedingungen.



## ALLESKÖNNER

- E** ALLROUNDER
- ES** EL POLIVALENTE



## HOHLZIEGEL

- E** CAVITY BRICKS
- ES** LADRILLOS HUECOS

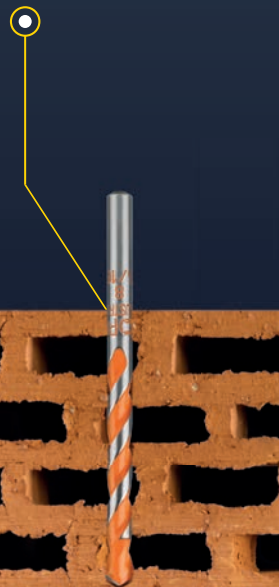

## HOLZ

- E** WOOD
- ES** MADERA

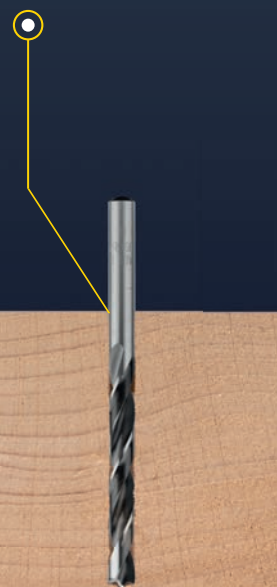

## BETON

- E** CONCRETE
- ES** HORMIGÓN



## GRANIT

- E** GRANITE
- ES** GRANITO





### **E** OUR VERSATILITY IS YOUR GAIN

*With our range of over 4,000 standard and special drills, we offer the perfect tool for every requirement. No matter where you work - with us you drill faster, easier and more economically. At the same time, we convince with quality, short drilling times and long tool life even under the toughest conditions.*

### **ES** NUESTRA VERSATILIDAD ES SU VENTAJA

*Con nuestra gama de más de 4000 brocas estándar y especiales, le garantizamos la herramienta perfecta para cada necesidad. No importa dónde trabaje: con nosotros perforará más rápido, más fácil y más económicamente. Al mismo tiempo, convencemos con la calidad, los cortos tiempos de perforación y la larga vida útil incluso en las condiciones más duras.*

#### METALL

- E** METAL
- ES** METAL



#### EDELSTAHL

- E** STAINLESS STEEL
- ES** ACERO INOXIDABLE



#### GLAS

- E** GLASS
- ES** VIDRIO



#### FLIESEN

- E** TILES
- ES** BALDOSAS



#### DACHZIEGEL

- E** ROOF TILES
- ES** TEJAS

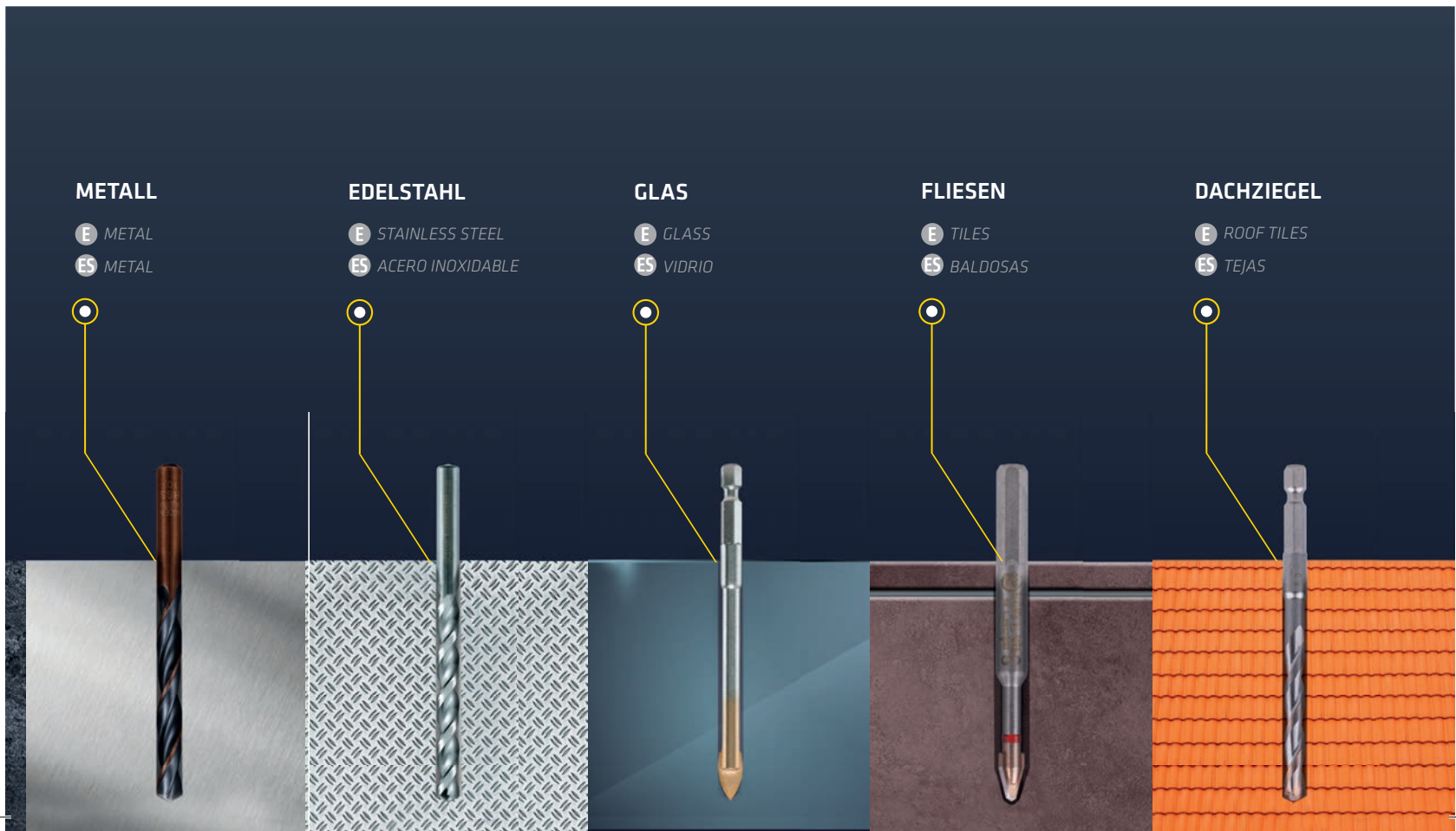

# DARAUF KÖNNEN SIE SICH **VERLASSEN**

*Egal wann, egal wo – wir sind für Sie da und kümmern uns mit vollem Einsatz um Ihr Anliegen.*

// Auf Basis von mehr als 60 Jahren Erfahrung und internationalen Netzwerken in über 70 Ländern liefern wir Ihnen eine Vielzahl an Produkten – täglich und weltweit. Dabei beraten wir Sie selbstverständlich allumfassend in vielen Sprachen. Indem wir flexibel unterschiedlichste IT-Anbindungen an Ihr Warenwirtschaftssystem realisieren, bestellen Sie noch unkomplizierter und einfacher.

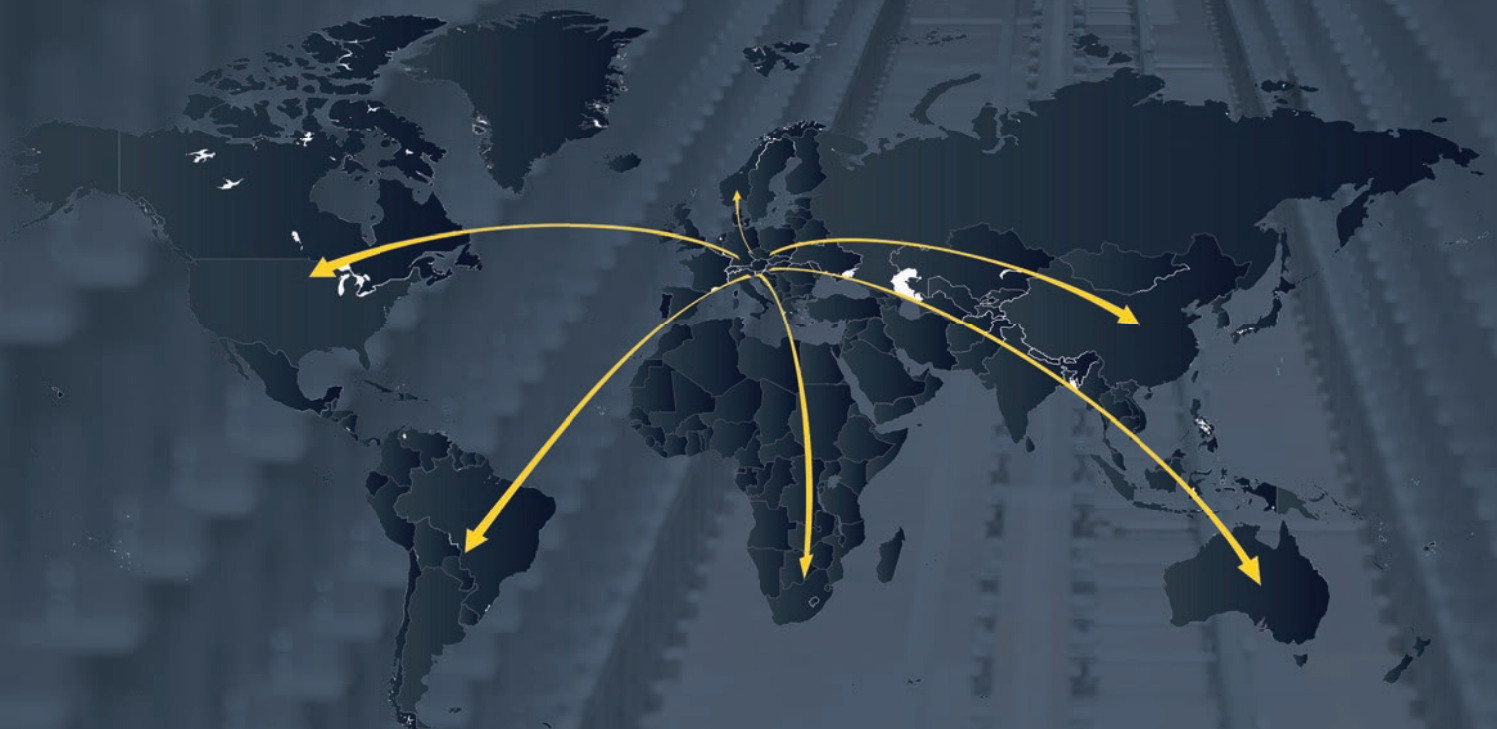

**E SERVICE YOU CAN RELY ON.**

*No matter when, no matter where - we are there for you and take care of your concerns with full commitment.*

*Based on more than 60 years of experience and international networks in over 70 countries, we deliver a wide range of products - daily and worldwide. And (needless to say) we advise you comprehensively in many languages. By flexibly implementing a wide variety of IT connections to your merchandise management system, you can order even more easily and conveniently.*

**ES UN SERVICIO EN EL QUE PUEDE CONFIAR.**

*No importa cuándo ni dónde, estamos a su disposición y nos ocupamos de sus preocupaciones con total compromiso.*

*Basándonos en más de 60 años de experiencia y en redes internacionales en más de 70 países, le suministramos una amplia gama de productos, a diario y en todo el mundo. Y (por supuesto) ofrecemos un asesoramiento completo en muchos idiomas. Gracias a la implementación flexible de una gran variedad de conexiones informáticas a su sistema de gestión de mercancías, podrá realizar pedidos de forma aún más fácil y sencilla.*



# WIR DENKEN FÜR SIE **VORAUSS**

// Wir wissen:  
nur mit neuester Technologie und einer kontinuierlichen Weiterentwicklung können wir Ihnen das beste Werkzeug für jede Anforderung bieten. Und so arbeitet unsere Forschungs- und Entwicklungsabteilung stetig daran, noch präzisere, langlebigere und bessere Produkte zu gestalten.

## **E** WE THINK IN ADVANCE ON YOUR BEHALF.

*We know that we can only offer you the best tool for every requirement with the latest technology and continuous further development. This is why our Research and Development department is constantly working on designing even more precise, more durable and better products.*

## **ES** PENSAMOS POR USTED POR ADELANTADO.

*Lo sabemos:  
sólo con la más novedosa tecnología y el continuo desarrollo podemos ofrecerle la mejor herramienta para cada necesidad. Por ello, nuestro departamento de investigación y desarrollo trabaja constantemente en el diseño de productos aún más precisos, más duraderos y mejores.*

# CLEAN UP CLEAN BETTER.

*Wir entwickeln uns ständig weiter - unser Gewerbepack auch!*

// Der Schutz der Umwelt betrifft uns alle und deshalb möchten wir auch hier einen Schritt weiter gehen. Unsere Gewerbepack-Verpackungen bestehen jetzt aus bereits recyceltem Material und sind ebenso wieder recycelbar.

**E WE ARE CONSTANTLY ENVOLVING -  
OUR INDUSTRIALPACK TOO!**

*The protection of the environment affects us all and that's the reason why we go one step further. Our Industrialpack is now made from material that has already been recycled and can also be recycled again.*

**ES ESTAMOS EVOLUCIONANDO CON-  
STANTEMENTE - NUESTRO PAQUETE  
INDUSTRIAL TAMBIÉN!**

*La protección del medio ambiente nos afecta a todos y por ello queremos dar un paso hacia adelante. Ahora nuestros paquetes industriales están fabricados a base de material reciclado y son de nuevo reciclables.*

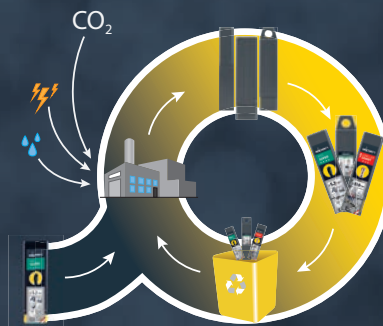
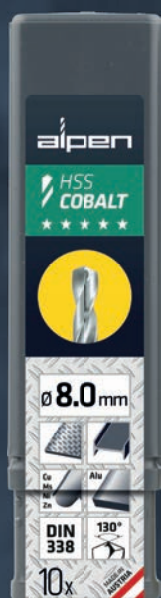

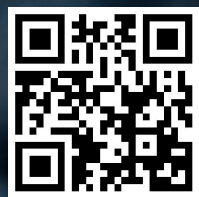



### Diebstahlschutz

- E Anti-theft protection
- ES Protección antirrobo

### Qualitätssystem

- E Quality system
- ES Sistema de calidad

### Produkt

- E Product
- ES Producto

### Infobox

- E Infobox
- ES Infobox

### Materialhintergrund

- E Material background
- ES Fondo del material



### Markenfläche & Farbleitsystem

- E Label space & colour guide system
- ES Espacio para la marca & sistema de guía por colores

### Sicherheitshinweise

- E Safety notes
- ES Instrucciones de seguridad

### Farbleitsystem & Produktname

- E Colour guide system & product name
- ES Sistema de guía por colores y nombre de los productos

### Selbsterklärende Verpackung

Das Farbleitsystem, unterschiedliche Qualitätsstufen, Informationsgrafiken sowie die eindeutige Zuordnung der Anwendung schaffen Klarheit und Verständnis am POS.

- E Self-Explanatory packaging  
The color coding system, different quality levels, information graphics and an unambiguous assignment of the application provide clarity and understanding at the POS.
- ES Envase intuitivo  
Claridad y comprensión en el punto de venta: El sistema de guía por colores, diferentes niveles de calidad, gráficos informativos y una indicación clara del ámbito de uso.

### Qualitätsstufen für jede Anforderung

- E Quality levels for every demand
- ES Niveles de calidad para todos los requisitos.





# ALLE INFORMATIONEN AUF EINEN BLICK.

*Sie sind neugierig geworden? Unser innovatives Verpackungsdesign informiert Sie schnell und effizient.*

// Unserer POS-Platzierungsoptionen Vereinen ansprechendes Design mit hoher Funktionalität. Somit informieren wir Sie unkompliziert und verständlich über unsere Vielzahl an Produkten. Dabei denken wir immer einen Schritt weiter: unsere Verpackungen sind zudem innovativ und umweltfreundlich gestaltet.

## **E** ALL INFORMATION AT A GLANCE.

*Are you curious? Our innovative packaging design informs you quickly and efficiently.*

*Our POS placement options combine attractive design with high functionality. So we inform you uncomplicated and understandable about our variety of products. We always think one step ahead: our packaging is also innovative and designed to be eco-friendly.*

## **ES** TODA LA INFORMACIÓN DE UN VISTAZO.

*¿Siente curiosidad? Nuestro innovador diseño de envases le informa de forma rápida y eficaz.*

*Nuestras opciones de presentación en el punto de venta combinan un diseño atractivo con una gran funcionalidad. De este modo, le informamos sobre nuestra amplia gama de productos de forma sencilla y comprensible. Y siempre pensamos un paso por delante: nuestros envases también están diseñados para ser innovadores y respetuosos con el medio ambiente.*



Metallkassette  
**E** Metal cassettes  
**ES** Caja de metal



SB-Aufhänger  
**E** Plastic tag  
**ES** Expositores para autoservicio



Kunststoffbox  
**E** Plastic box  
**ES** Embalaje de plástico



Kunststoffkassette  
**E** Plastic cassettes  
**ES** Caja de plástico



Kombiset  
**E** Mix-packs  
**ES** Juego combinado



# VIELFÄLTIGES KASSETTEN SORTIMENT.

// Wir bieten unseren Kunden ein breites Angebot an Set- und Kassettenlösungen, um den unterschiedlichsten Bedürfnissen zu entsprechen.

## E NUMEROUS CASSETTE OPTIONS.

We offer a broad selection of sets and cassette options to cover our customers' varying requirements.

## ES GRAN VARIEDAD DE CAJAS.

Asimismo, ofrecemos a nuestros clientes una amplia oferta de juegos y cajas para satisfacer las necesidades más variadas.



Drehzahltabellen  
Spindle speed chart  
Tabla de revoluciones

Diebstahlschutz  
Anti-theft protection  
Protección antirobo

Einfache Entnahme der Bohrer  
Easy remove of the drills  
Broca fácil de sacar

Funktionelles und modernes Design  
Functional and state-of-the-art design  
Diseño moderno y funcional

Passendes Materialmotiv  
Respective material motive  
Imagen de materiales compatibles

Absolut bruchfest  
Absolutely break-resistant  
Totalmente resistente a la rotura

Diebstahlschutz  
Anti-theft protection  
Protección antirobo



Kunststoffkassetten – schmale Bauform  
Plastic cassettes – narrow size  
Cajas de plástico – versión estrecha

Kunststoffkassetten – breite Bauform  
Plastic cassettes – wide size  
Cajas de plástico – versión ancha



# UNSERE **ERFAHRUNGEN** AM POS

## *Vielfältige POS-Präsentation für jeden Bedarf*

- // Unsere **markterprobten Verkaufssysteme** erhöhen den Flächenumsatz und steigern Ihren Ertrag.
- // Für jeden Platzbedarf **das zielführende Verkaufssystem:** Vom Thekendisplay bis zur kompletten Präsentationswand.
- // Produktschilder in der gewünschten Landessprache, **das verständliche Farbleitsystem** und die **marktgerechten Bestückungsvarianten** bieten eine optimale und übersichtliche Präsentation am POS und somit einen starken Abverkauf.

### **E** **OUR EXPERIENCE** **AT THE POINT OF SALE**

#### **Wide range of POS presentations for any shop**

*Our market-approved sales systems increase the sales density and raise your revenue.*

*Fits perfect. The appropriate sales systems for every space:*

*From counter displays up to complete presentation walls.*

*Product labels in the local language, the comprehensible colour coding system and the market-driven display assortment provide optimum and clear presentation at the POS and raise your revenue.*

### **ES** **NUESTRA EXPERIENCIA** **EN EL PUNTO DE VENTA**

#### **Diferentes presentaciones para cada tipo de necesidad**

*Nuestros sistemas de venta probados en el mercado aumentan el volumen de venta de la superficie e incrementan sus beneficios.*

*Tenemos los sistemas de venta apropiados en el mercado para todas las necesidades de espacio: Desde el expositor de mostrador hasta el panel de presentación.*

*Los carteles de los productos en el idioma deseado, un comprensible sistema de guía por colores, juntos con los modelos de montaje competitivos ofrecen una presentación óptima en el punto de venta y, por lo tanto, unas ventas de una forma rápida.*

**D POS KNOW HOW VON ALPEN.**

Erhöhung des Flächenumsatzes und Profits.

Durch die Auswahl von Qualitätsstufen und Sorten für verschiedene Materialien haben die Kunden die Möglichkeit sich zu entscheiden. Dadurch entscheidet man sich sehr oft für eine bessere Qualität. ... und deshalb gibt es höhere Margen am Point of Sale

*Due to the assortment of quality levels and types for different materials the customer has the choice to decide! Thereby the customer decides very often for a better quality ... that's why we create higher turnovers and profits for all at the Point of Sale*

*Los clientes tienen la posibilidad de elegir entre varios niveles de calidad y tipos de materiales. De este modo se deciden normalmente por una mejor calidad. ... y esto significa un margen de beneficio mayor para el punto de venta*

// Fortlaufende Platzierung des Farbleitsystems | Continuous placement of the colour system  
*Posicionamiento continuo del sistema de guía por colores*



**ALPEN MODULPREISLISTE**  
Individuelle Angebotserstellung mit Visualisierung im Excel.  
**ALPEN MODULE PRICE LIST**  
Individual offer creation with visualization in Excel.  
**LISTA DE PRECIOS ALPEN**  
Creación de ofertas individuales con visualización en Excel.

Sortimentsbreite | Product range | Gama de productos

**D GARANTIERT STARKER ABVERKAUF.**



**Sortenreine Präsentation**  
*Unmixed presentation*  
*Presentación ordenada por tipos de material*

**E GUARANTEED STRONG SALES.**



**Anwendungsgleiche Präsentation**  
*Same application presentation*  
*Presentación por tipos de uso*

**ES GARANTIZA LA VENTA RÁPIDA.**



**Spezielle 6-kant Bohrer Präsentation**  
*Special hexagonal shank presentation*  
*Presentación especial de brocas hexagonales*

**D DAS PERFEKTE ANGEBOT.**

Markterprobtes POS-Know-how für starken Abverkauf. Für jeden Platzbedarf haben wir das passende Display.

**E THE PERFECT OFFER.**

Market-approved POS know-how for strong sales. We have the right display for every available space.

**ES LA OFERTA PERFECTA.**

Conocimientos del punto de venta probados en el mercado para obtener ventas de una forma rápida. Tenemos los expositores adecuados para todas las necesidades de espacio.



**Boden-Display**  
Ground display  
Expositor de pie



**Bohrer-Display**  
Drill display  
Expositor con forma de broca



**Präsentationswand**  
Presentation wall  
Panel de presentación



**Metall-Magazinschrank**  
Metal cabinet  
Cajón metálico con estantes



**Säulen-Display**  
Pillar display  
Expositor de columna



**Theken-Display**  
Counter-display  
Expositor para mostrador







































**Karton-Display**  
Cardboard display  
Expositor de cartón



**D** ZEICHENERKLÄRUNG

**E** SIGNS AND SYMBOLS

**ES** SIGNIFICADO DE LOS SIMBOLOS

	<b>Armierter Beton</b> Reinforced concrete Hormigón armado		<b>Allgemeine Baustähle</b> Structural steels Aceros de construcción generales		<b>Weichholz</b> Soft wood Madera blanda
	<b>Beton</b> Concrete Hormigón		<b>Automatenstähle</b> Free cutting steels Aceros de corte fácil		<b>Mittelweiches Holz</b> Medium soft wood Madera media blanda
	<b>Stein</b> Natural stone Piedra		<b>Unlegierte Vergütungsstähle</b> Unalloyed heat treatable steels Aceros para bonificar no aleados		<b>Hartholz</b> Hard wood Madera dura
	<b>Vollziegel</b> Solid brick Ladrillo macizo		<b>Legierte Vergütungsstähle</b> Alloyed heat treatable steels Aceros para bonificar aleados		<b>Holz geleimt</b> Glued timbers Madera encolada
	<b>Hohlziegel</b> Cavity brick Ladrillo hueco		<b>Metall</b> Metal Metal		<b>Holzbalken</b> Joiced timbers Viga de madera
	<b>Dachziegel</b> Roof tile Teja		<b>Rostfreie Stähle</b> Stainless steels Aceros inoxidables		<b>Verleimter Holzbalken</b> Glued joiced timbers Viga de madera pegada
	<b>Dachziegel 1x</b> Roof tile 1x Teja 1x		<b>Blech</b> Sheet metal Chapa		<b>Spanplatte</b> Chipboard Tabla de madera aglomerada
	<b>Dachziegel 2x</b> Roof tile 2x Teja 2x		<b>Grauguss, Temperguss</b> Grey cast iron, malleable cast iron Hierro fundido gris, fundición maleable		<b>Beschichtete Spanplatte</b> Coated chipboard Tablero de virutas revestido
	<b>Marmor</b> Marble Mármol		<b>Titan- und Titanlegierungen</b> Titanium and titanium alloys Titanio y aleaciones de titanio		<b>Resopal</b> Laminated Chipboard Resopal
	<b>Granit</b> Granite Granito		<b>Kupfer, Messing</b> Copper, brass Cobre, latón		<b>Gipskarton</b> Gypsum plaster boards Cartón yeso
	<b>Verbund</b> Composites Combinación		<b>Aluminium</b> Aluminio Aluminio		
	<b>Fliesen</b> Tiles Baldosas		<b>Kunststoffe</b> Plastics Plásticos		
	<b>Fein-Steinzeugfliesen</b> Ceramic tiles Baldosas de gres porcelánicos				
	<b>Glas</b> Glass Vidrio				
	<b>Diamant Beschichtung</b> Diamond coating Recubrimiento de diamante				

**D** TECHNISCHE ZEICHNUNGEN

**E** TECHNICAL DRAWINGS

**ES** DIBUJOS TECNICOS



- d1 Schneiddurchmesser  
Cutting diameter | Diámetro de corte
- d2 Schaft | Shank | Eje
- d3 Freistellung | Neck | Cuello
- d4 Zapfen-/Spiegeldurchmesser  
Ø pilot / mirror | Diámetro piloto
- d5 Senkdurchmesser  
Ø countersink | Diámetro avellanador
- a Schlüsselweite | Wrench size | Anchura casquillo
- b Breite | Width | Anchura
- l1 Gesamtlänge | Total length | Longitud total
- l2 Schneidlänge | Cutting length | Longitud de corte
- l3 Freistelllänge | Neck length | Longitud cuello
- l4 Bohrlänge | Drilling length | Longitud de taladro
- l5 Dübelbohrlänge / Gewindelänge  
Dowel drilling length / thread length  
Longitud de anclaje / Longitud de rosca



**D ZEICHENERKLÄRUNG**

**E SIGNS AND SYMBOLS**

**ES SIGNIFICADO DE LOS SIMBOLOS**

<b>CV</b>	Chrom-Vanadium Chrome-Vanadium Cromo-vanadio	<b>WN</b>	Werksnorm Works standard Norma interna	<b>A</b>	Anschnittformen Cutting form Formas de corte de entrada
<b>HSS</b>	Hochleistungsschnellarbeitsstahl High Speed Steel El acero de alta velocidad	<b>M</b>	Metrisches Gewinde Metric threads Rasca metrica	<b>PZ</b>	Werkzeug Typ Tool type Tipo de herramienta
<b>HSS Co5</b>	5% kobaltlegierter HSS-Stahl 5% cobalt-alloyed high speed steel Acero HSS aleado con un 5% de cobalto	<b>G</b>	Rohrgewinde Pipe threads Rasca para tubos	<b>3.d</b>	Bohrtiefe Drilling depth Hondura de perforar
<b>HSS TiN</b>	Titan-Nitrid-Beschichtung Titanium-Nitride-coating Recubrimiento titanio nitrato	<b>SICHERSAFE</b>	Prüfzeichen Mauerbohrer Approval mark masonry drills Certificado brocas de albañilería	<b>120°</b>	Spitzenwinkel Point angle Ángulo de punta
<b>HM</b>	Hartmetall Carbide Metal duro	<b>Flächenanschliff</b>	Flächenanschliff Facet ground forms Formas de la faceta	<b>35°</b>	Drallsteigung Spiral grade Paso de hélice
	Akkuboherer Cordless drill Taladro con batería	<b>Stirnverzahnung</b>	Stirnverzahnung Spur gearing Dentado frontal	<b>102°-138°</b>	Ungleichteilung Senker Unequal spacing - countersink División irregular de avellanadores
	Bohrmaschine Drilling machine Taladro	<b>55° P</b>	Gewindeflankenwinkel Thread flank angle Ángulo de flanco de rosca	<b>Shank</b>	3-Flächenschaft 3-surface shank Eje triangular
	Bohrhammer Hammer drill machine Martillo perforador	<b>Gewindegänge</b>	Gewindegänge Thread convolution Pasos de rosca		6-Kantschaft Hexagonal shank Eje hexagonal
	Drehbohren Rotary drilling Solo taladrado rotativo	<b>Gewinde</b>	Gewinde Thread Rosca		Senkkopf Countersink head Cabeza avellanada
	Schlagbohren Percussion drilling Perforación a percusión	<b>≤1,5d1</b>	Durchgangsbohrung Tapped through hole Rosca pasante	<b>90°</b>	Senkwinkel Countersink angle Ángulo de avellanar
<b>ISO 2 6H</b>	Toleranz GWB Dimensions according to DIN Tolerancia de machos de roscar		Durchgangs- und Grundgewinde Through hole and blind hole threads Roscas pasante y roscas ciega	<b>R1</b>	Reihen nach DIN 1869 Rows according to DIN 1869 Serie según DIN 1869
<b>DIN 1897</b>	Baumaße nach DIN Tap tolerance Tolerancia de machos de roscar	<b>6g</b>	Toleranzfeld Tolerance zone Dominio de tolerancia		Verpackungseinheit Packing unit Unidad de embalaje

**D SCHAFTAUSFÜHRUNGEN**

**E SHANK DESIGNS**

**ES DISEÑOS DE EJES**













	1/4" Sechskantschaft 1/4" hexagonal shank Eje hexagonal 1/4"		SDS-plus mit Schlag Stopp Funktion SDS-plus with hammer-stop function SDS-plus con parada de percusión		SDS-plus Schaft SDS-plus shank Eje SDS-plus		SDS-max Schaft SDS-max shank Eje SDS-max
	Zylindrischer Schaft Cylindrical shank Eje cilíndrico		Reduzierter Schaft Reduced shank Eje reducido		Morsekegelschaft Morse taper shank Eje con cono Morse		Anti-slip Schaft Anti-slip shank Eje antideslizante
	Sechskantschaft Hexagonal shank Eje hexagonal		3-Flächenschaft 3-surface shank Eje de 3 caras		Vierkantschaft Square shank Eje cuadrado		Grip Schaft Grip shank Eje de agarre



# ÜBERSICHT BOHRER MIT 1/4"-SECHSKANTSCHAFT

**E** OVERVIEW  
DRILL BITS WITH  
1/4" HEXAGONAL SHANK

**ES** RESUMEN DE BROCAS  
CON CODO HEXAGONAL  
1/4"

	Name / Nombre	Code / Código	Seite / Page / Página
	Profi Multicut	272	33
	Profi Dach	252, 253	43
	Profi Diamant	290	53
	Profi Glas	289	54
	Profi Beton	189	69
	Pro	952	155
	Profi Holz	622	198
		237, 238	211
		702	285
		703	286
		720	302
		0070503071100	

A photograph of two men working on a brick wall. The man in the foreground is wearing a yellow hard hat and a blue and red plaid shirt, holding a large grey power tool. The man in the background is wearing a white t-shirt and is using a black power drill to drill into the brick wall. The background is a dark, cloudy sky.

# SPEZIALBOHRER

// MEHRZWECKBOHRER, BOHRER FÜR HOHLZIEGEL, DACHZIEGEL,  
GRANIT, FEINSTEINZEUG, FLIESEN, KERAMIK UND GLAS



### **E** *SPECIAL DRILL BITS*

- // MULTIPURPOSE DRILL BITS
- // DRILL BITS FOR CAVITY BRICKS
- // ROOF TILES
- // GRANITE
- // PORCELAIN/GRES
- // TILES
- // CERAMIC AND GLASS

### **ES** *BROCAS ESPECIALES*

- // BROCAS MULTIUSOS
- // BROCAS PARA LADRILLOS HUECOS
- // TEJAS
- // GRANITO
- // GRES PORCELÁNICO
- // BALDOSAS
- // CERÁMICA Y VIDRIO

Übersicht

Overview

Resumen

						
Norm / Estándar	WN	WN	WN	WN	WN	WN
Name / Nombre	Profi Multicut	Profi Multicut	Profi Multicut	Profi Multicut	Profi Ziegel	DUST EXTRACTOR SHARP
Schaft / Shank / Eje						
Ø mm	3,00 - 12,00	5,00 - 16,00	4,00 - 10,00	5,00 - 20,00	4,00 - 10,00	6,00 - 16,00
Code / Código	172	729-730	272	509, 519, 529, 539, 579	352	680
Seite / Page / Página	31	32	33	34	39	41
Geeignet für / Suitable for / Adecuada para						
 <b>Beton</b> Concrete Hormigón						
 <b>Stein</b> Natural stone Piedra						
 <b>Vollziegel</b> Solid brick Ladrillo macizo						
 <b>Hohlziegel</b> Cavity brick Ladrillo hueco						
 <b>Dachziegel 1x</b> Roof tile 1x Teja 1x						
 <b>Dachziegel 2x</b> Roof tile 2x Teja 2x						
 <b>Marmor</b> Marble Mármol						
 <b>Granit</b> Granite Granito						
 <b>Fliesen</b> Tiles Baldosas						
 <b>Fein-Steinzeugfliesen</b> Ceramic tiles Baldosas de gres porcelánicos						
 <b>Holz</b> Natural Madera						
 <b>Metall</b> Metal Metal						
 <b>Kunststoffe</b> Plastics Plásticos						
 <b>Glas</b> Glass Vidrio						

Übersicht

Overview

Resumen



Spezialbohrer  
special drill bit  
broca especial

							
WN	DIN ISO 5468	DIN ISO 5468	WN	WN	DIN 5468	WN	WN
Profi Dach	Profi Granit	Longlife Granit	C PROTECTOR	Keramo Extreme	Profi Keramo	Profi Diamant	Profi Glas
							
3,50 - 6,00	4,00 - 14,00	4,00 - 12,00	5,00 - 14,00	5,00 - 14,00	4,00 - 12,00	5,00 - 15,00	3,00 - 12,00
252-253	257	258	303	300	297	290	289
43	45	46	48	50	52	53	54
							
							
							
							
							
							
							
							
							
							
							
							



## **PROFI MULTICUT**



### **Der Alleskönner**

Flexible Einsatzmöglichkeiten bei unterschiedlichen Materialien ohne Bohrerwechsel

### **The all-rounder**

*Flexible application possibilities for different materials without changing the drill bit*

### **El polivalente**

*Diversas posibilidades de uso en materiales diferentes sin necesidad de cambiar de broca*

### **Extra scharfe Schneiden**

Diamantgeschliffene, scharfe Schneiden ermöglichen Bohren auch in Metall

### **Extra sharp cutting edges**

*Diamond-ground, sharp cutting edges enable drilling even in metal*

### **Filos especialmente afilados**

*Los filos afilados pulidos con diamante permiten incluso la perforación de metal*

### **Patentiertes 4-fach Stufenprofil**

Schnelle Bohrmehlförderung beim Bohren in Mauerwerk und Beton

### **Patented 4-step profile**

*Fast drill dust feed when drilling into masonry and concrete*

### **Perfil cuádruple escalonado patentado**

*Rápida eliminación de los detritos durante la perforación en mampostería y hormigón*





**D Hartmetall-Mehrzweckbohrer mit zylindrischem Schaft, kurz**

**Einsatzbereich:**

Hohe Flexibilität und präzise Bohrung - auch bei abwechselndem Bohren in unterschiedlichen Materialien. Zum Drehbohren in Fliesen, Mauerwerk, Metall, Holz und Kunststoff.

**E Tungsten carbide multi purpose drill bits with cylindrical shank, short series**

**Range of application:**

Extremely versatile and precise drilling - even with changing drills in various materials. For precision rotary drilling in tiles, natural stone, metal, wood and plastics.

**ES Broca multiuso de metal duro, con eje cilíndrico, corta**

**Ámbito de aplicación:**

Elevada flexibilidad y taladrados precisos, incluso si se cambian las brocas en materiales diversos. Para el taladrado rotativo en baldosas, mampostería, metal, madera y plástico.



Spezialbohrer  
special drill bit  
broca especial



Universeller Spezialbohrer  
Universal special drill bits  
Taladradora especial universal



Für Metall, Mauerwerk und Fliesen  
For metal, masonry and tiles  
Para metal, albañilería y baldosas



Diamantgeschliffene, scharfe Schneiden  
Diamond ground, sharp cutting edges  
Filos muy afilados pulidos con diamante

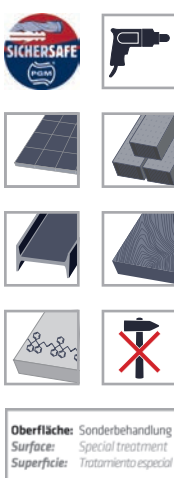

Oberfläche: Sonderbehandlung  
Surface: Special treatment  
Superficie: Tratamiento especial



Einzelverpackung  
Single pack  
Embalaje individual

d1 mm	d1 inch	l1 mm	l2 mm	d2	Code 172 Art.-Nr.	Inh. Cont.	
3,00	1/8	60	30		0017200300100	1	10
4,00	5/32	75	39		0017200400100	1	10
5,00	3/16	85	39		0017200500100	1	10
5,50		85	39		0017200550100	1	10
6,00	15/64	100	54		0017200600100	1	10
6,50	1/4	100	54		0017200650100	1	10
7,00	9/32	100	54		0017200700100	1	10
8,00	5/16	120	80		0017200800100	1	10
10,00	3/8	120	80		0017201000100	1	10
12,00	15/32	150	90	10,00	0017201200100	1	10

**① Hartmetall-Mehrzweckbohrer mit zylindrischem Schaft, lang**

**Einsatzbereich:**

Zum Drehbohren in Fliesen, Mauerwerk, Metall, Holz und Kunststoff. Durch extra-lange Ausführung mehr Möglichkeiten bei der Fenstermontage: Bohren von Kunststoff, Metall und Mauerwerk in einem Arbeitsgang.

**② Tungsten carbide multi purpose drill bits with cylindrical shank, long series**

**Range of application:**

For precision rotary drilling in tiles, natural stone, metal, wood and plastics. Due to its extra long version more options when installing windows: drill through plastics, metal and masonry in one work step.

**③ Broca especial de metal duro con eje cilíndrico, larga**

**Ámbito de aplicación:**

Para el taladrado rotativo en baldosas, mampostería, metal, madera y plástico. Gracias al diseño extralargo, hay más posibilidades para el montaje de ventanas: taladrado de plástico, metal y mampostería en una misma operación.



Universeller Spezialbohrer  
Universal special drill bits  
Taladradora especial universal



Für Metall, Mauerwerk und Fliesen  
For metal, masonry and tiles  
Para metal, albañilería y baldosas



Diamantgeschliffene, scharfe Schneiden  
Diamond ground, sharp cutting edges  
Filos muy afilados pulidos con diamante

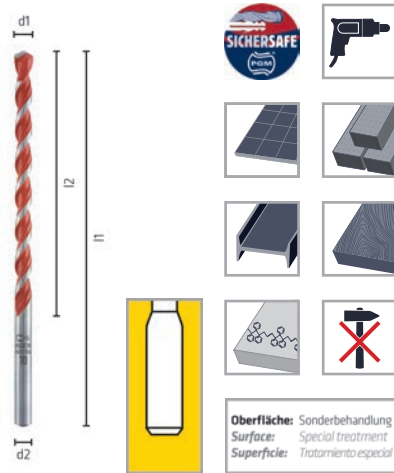

Oberfläche: Sonderbehandlung  
Surface: Special treatment  
Superficie: Tratamiento especial



Einzelverpackung  
Single pack  
Embalaje individual

d1 mm	d1 inch	l1 mm	l2 mm	d2	Code 729 Art.-Nr.	Inh. Cont.	
5,00	3/16	150	85		0072900500100	1	10
5,50		150	85		0072900550100	1	10
6,00	15/64	200	135		0072900600100	1	10
6,50	1/4	200	135		0072900650100	1	10
7,00	9/32	200	135		0072900700100	1	10
8,00	5/16	200	135		0072900800100	1	10
10,00	3/8	200	135		0072901000100	1	10
12,00	15/32	220	150	10,00	0072901200100	1	10
14,00	9/16	220	150	10,00	0072901400100	1	10

Länge / Length / Longitud: 400/300 mm

d1 mm	d1 inch	l1 mm	l2 mm	d2	Code 730 Art.-Nr.	Inh. Cont.	
5,00	3/16	400	300		0073000500100	1	10
5,50		400	300		0073000550100	1	10
6,00	15/64	400	300		0073000600100	1	10
6,50	1/4	400	300		0073000650100	1	10
8,00	5/16	400	300		0073000800100	1	10
10,00	3/8	400	300		0073001000100	1	10
12,00	15/32	400	300	10,00	0073001200100	1	10
14,00	9/16	400	300	10,00	0073001400100	1	10
16,00	5/8	400	300	10,00	0073001600100	1	10

**D Hartmetall-Mehrzweckbohrer mit 1/4"-Sechskantschaft**

**Einsatzbereich:**

Zum Drehbohren in Fliesen, Mauerwerk, Metall, Holz und Kunststoff. Passend für jeden Standard-Akkuschrauber durch genormtes Schaftprofil.

**E Tungsten carbide multi purpose drill bits with 1/4" hexagonal shank**

**Range of application:**

For precision rotary drilling in tiles, natural stone, metal, wood and plastics. Ideal for all standard cordless drills thanks to its standardized shank profile.

**ES Broca multiuso de metal duro con eje hexagonal 1/4"**

**Ámbito de aplicación:**

Para el taladrado de baldosas, mampostería, metal, madera y plástico. Adecuadas para todos los destornilladores con baterías convencionales gracias al perfil de eje normativo.



Spezialbohrer  
special drill bit  
broca especial



Universeller Spezialbohrer  
Universal special drill bits  
Taladradora especial universal



Für Metall, Mauerwerk und Fliesen  
For metal, masonry and tiles  
Para metal, albañilería y baldosas



Diamantgeschliffene, scharfe Schneiden  
Diamond ground, sharp cutting edges  
Filos muy afilados pulidos con diamante

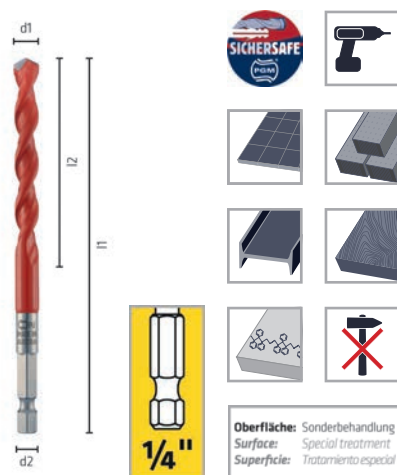

Oberfläche: Sonderbehandlung  
Surface: Special treatment  
Superficie: Tratamiento especial



Einzelverpackung  
Single pack  
Embalaje individual

d1 mm	d1 inch	l1 mm	l2 mm	d2 mm	Code 272 Art.-Nr.	Inh. Cont.	
4,00	5/32	100	39	1/4"	0027200400100	1	10
5,00	3/16	100	39	1/4"	0027200500100	1	10
5,50		100	39	1/4"	0027200550100	1	10
6,00	15/64	100	54	1/4"	0027200600100	1	10
7,00	9/32	100	54	1/4"	0027200700100	1	10
8,00	5/16	120	80	1/4"	0027200800100	1	10
10,00	3/8	120	80	1/4"	0027201000100	1	10

**1 Hartmetall-Mehrzweckbohrer mit SDS-plus Schaft**

**Einsatzbereich:**

Zum Drehbohren in Fliesen, Mauerwerk, Metall, Holz und Kunststoff. Spezielle Schaftausführung mit automatischer Schlag-Stopp Funktion für SDS-plus Bohrhämmer, dadurch deutliche Verlängerung der Standzeit des Bohrers.



Automatische Schlag-Stopp Funktion  
Automatic hammer-stop function  
Función de parada automática



Für Metall, Mauerwerk und Fliesen  
For metal, masonry and tiles  
Para metal, albañilería y baldosas



Diamantgeschliffene, scharfe Schneiden  
Diamond ground, sharp cutting edges  
Filos muy afilados pulidos con diamante

**E Tungsten carbide multipurpose drill bits with SDS-plus shank**

**Range of application:**

For rotary drilling in tiles, masonry, metal, wood and plastics. Special shank design with automatic hammer-stop function for SDS-plus hammer drills with a significantly longer service life.

**ES Broca multiuso con eje SDS-plus**

**Ámbito de aplicación:**

Para el taladrado rotativo de baldosas, mampostería, metal, madera y plástico. La realización del eje especial con función automática de parada de percusión para su uso con martillos perforadores SDS-plus permite que la broca se utilice durante un periodo mucho más prolongado.



Oberfläche: Sonderbehandlung  
Surface: Special treatment  
Superficie: Tratamiento especial



Einzelverpackung  
Single pack  
Embalaje individual

Länge / Length / Longitud: 110/50 mm

d1 mm	l1 mm	l2 mm	d2	Code 509 Art.-Nr.	Inh. Cont.	
5,00	110	50	SDS-plus	0050900500100	1	10
6,00	110	50	SDS-plus	0050900600100	1	10
8,00	110	50	SDS-plus	0050900800100	1	10

Länge / Length / Longitud: 160/100 mm

d1 mm	l1 mm	l2 mm	d2	Code 519 Art.-Nr.	Inh. Cont.	
5,00	160	100	SDS-plus	0051900500100	1	10
6,00	160	100	SDS-plus	0051900600100	1	10
7,00	160	100	SDS-plus	0051900700100	1	10
8,00	160	100	SDS-plus	0051900800100	1	10
10,00	160	100	SDS-plus	0051901000100	1	10
12,00	160	100	SDS-plus	0051901200100	1	10
14,00	160	100	SDS-plus	0051901400100	1	10

Einzelverpackung  
Single pack  
Embalaje individual

Länge / Length / Longitud: 210/150 mm

d1 mm	l1 mm	l2 mm	d2	Code 529 Art.-Nr.	Inh. Cont.	
6,00	210	150	SDS-plus	0052900600100	1	10
8,00	210	150	SDS-plus	0052900800100	1	10
10,00	210	150	SDS-plus	0052901000100	1	10
12,00	210	150	SDS-plus	0052901200100	1	10
14,00	210	150	SDS-plus	0052901400100	1	10

Länge / Length / Longitud: 260/200 mm

d1 mm	l1 mm	l2 mm	d2	Code 539 Art.-Nr.	Inh. Cont.	
6,00	260	200	SDS-plus	0053900600100	1	10
6,50	260	200	SDS-plus	0053900650100	1	10
8,00	260	200	SDS-plus	0053900800100	1	10
10,00	260	200	SDS-plus	0053901000100	1	10
12,00	260	200	SDS-plus	0053901200100	1	10
14,00	260	200	SDS-plus	0053901400100	1	10
16,00	260	200	SDS-plus	0053901600100	1	10

Länge / Length / Longitud: 450/400 mm

d1 mm	l1 mm	l2 mm	d2	Code 579 Art.-Nr.	Inh. Cont.	
6,50	450	400	SDS-plus	0057900650100	1	10
8,00	450	400	SDS-plus	0057900800100	1	10
10,00	450	400	SDS-plus	0057901000100	1	10
12,00	450	400	SDS-plus	0057901200100	1	10
14,00	450	400	SDS-plus	0057901400100	1	10
16,00	450	400	SDS-plus	0057901600100	1	10
18,00	450	400	SDS-plus	0057901800100	1	10
20,00	450	400	SDS-plus	0057902000100	1	10



Spezialbohrer  
special drill bit  
broca especial











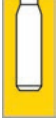





Automatische  
Schlag-Stopp-Funktion  
Automatic hammer-stop  
function  
Función automática de  
parada de percusión



**D** Kassetten, Sets

**E** Cassettes, sets

**ES** Cajas, juegos

<p><b>Profi Multicut PM 3</b></p>   <p>3-tlg. / 3-pcs. / 3-unid. Kunststoffkassette / Plastic cassette / Caja de plástico Art.-Nr. 0000100703100</p>			<p><b>Profi Multicut PM 5</b></p>   <p>5-tlg. / 5-pcs. / 5-unid. Kunststoffkassette / Plastic cassette / Caja de plástico Art.-Nr. 0000100705100</p>			<p><b>Profi Multicut BOX 4</b></p>   <p>4-tlg. / 4-pcs. / 4-unid. Kunststoffbox / Plastic box / Caja de plástico Art.-Nr. 0000100808100</p>		
<b>Ø</b> mm	<b>Stk.</b> <sup>(1)</sup> <b>pc.</b> <sup>(1)</sup>	<b>Ø</b> mm	<b>Stk.</b> <sup>(1)</sup> <b>pc.</b> <sup>(1)</sup>	<b>Ø</b> mm	<b>l1</b> mm	<b>Stk.</b> <sup>(1)</sup> <b>pc.</b> <sup>(1)</sup>		
Profi Multicut		Profi Multicut		Profi Multicut				
Ø 5,00 / 6,00 / 8,00	1	Ø 4,00 / 5,00 / 6,00 / 8,00 / 10,00	1	Ø 6,00 / 8,00 / 10,00 / 12,00	400	1		
<p><b>Profi Multicut ATM 3</b></p>   <p>3-tlg. / 3-pcs. / 3-unid. Kunststoffkassette / Plastic cassette / Caja de plástico Art.-Nr. 0000100803100</p>			<p><b>Profi Multicut ATM 5</b></p>   <p>5-tlg. / 5-pcs. / 5-unid. Kunststoffkassette / Plastic cassette / Caja de plástico Art.-Nr. 0000100805100</p>			<p><b>Profi Multicut ATM 6</b></p>   <p>6-tlg. / 6-pcs. / 6-unid. Kunststoffkassette / Plastic cassette / Caja de plástico Art.-Nr. 0000100802100</p>		
<b>Ø</b> mm	<b>Stk.</b> <sup>(1)</sup> <b>pc.</b> <sup>(1)</sup>	<b>Ø</b> mm	<b>Stk.</b> <sup>(1)</sup> <b>pc.</b> <sup>(1)</sup>	<b>Ø</b> mm	<b>Stk.</b> <sup>(1)</sup> <b>pc.</b> <sup>(1)</sup>			
Profi Multicut		Profi Multicut		Profi Multicut				
Ø 5,00 / 6,00 / 8,00	1	Ø 4,00 / 5,00 / 6,00 / 8,00 / 10,00	1	Ø 4,00 / 5,00 / 6,00 / 7,00 / 8,00 / 10,00		1		
<p><b>Profi Multicut SPM 5</b></p>   <p>5-tlg. / 5-pcs. / 5-unid. Kunststoffkassette / Plastic cassette / Caja de plástico Art.-Nr. 0000100905100</p>			<p><b>Profi Multicut BOX 4</b></p>   <p>4-tlg. / 4-pcs. / 4-unid. Kunststoffbox / Plastic box / Caja de plástico Art.-Nr. 0057900004100</p>			<p><b>Combi Construction Set SDS-plus MB 7</b></p>   <p>7-tlg. / 7-pcs. / 7-unid. Kunststoffkassette / Plastic cassette / Caja de plástico Art.-Nr. 0000100007100</p>		
<b>Ø</b> mm	<b>l1</b> mm	<b>Stk.</b> <sup>(1)</sup> <b>pc.</b> <sup>(1)</sup>	<b>Ø</b> mm	<b>l1</b> mm	<b>Stk.</b> <sup>(1)</sup> <b>pc.</b> <sup>(1)</sup>	<b>Ø</b> mm	<b>l1</b> mm	<b>Stk.</b> <sup>(1)</sup> <b>pc.</b> <sup>(1)</sup>
Profi Multicut			Profi Multicut			F4 Forte		
Ø 5,00 / 6,00	110	1	Ø 8,00 / 10,00 / 12,00 / 16,00	450	1	Ø 5,00	110	1
Ø 6,00 / 8,00 / 10,00	160	1				Ø 6,00 / 8,00 / 10,00	160	1
						Profi Multicut		
						Ø 5,00	110	1
						Ø 6,00 / 8,00	160	1

<sup>(1)</sup> Stück je Abmessung / Pieces each dimension / Piezas por diámetro

**D** Kassetten, Sets

**E** Cassettes, sets

**ES** Cajas, juegos

KIT SET 13-1		KIT SET 13	
			
13-tlg. / 13-pcs. / 13-unid. Set Art.-Nr. 0000303213100		13-tlg. / 13-pcs. / 13-unid. Set Art.-Nr. 0000303513100	
Ø mm	Stk. <sup>(1)</sup> pc. <sup>(1)</sup>	Ø mm	Stk. <sup>(1)</sup> pc. <sup>(1)</sup>
C PROTECTOR		C PROTECTOR	
Ø 5,00 / 6,00 / 8,00	1	Ø 6,00 / 8,00 / 10,00	1
F4 Forte		FORCE X	
Ø 5,00 / 6,00 / 8,00	1	Ø 6,00 / 8,00 / 10,00	1
Profi Multicut		Profi Multicut	
Ø 5,00 / 6,00 / 8,00	1	Ø 6,00 / 8,00 / 10,00	1
Wera		Wera	
4 Bits sortiert / 4 Bits sorted / 4 brocas surtidas		4 Bits sortiert / 4 Bits sorted / 4 brocas surtidas	



Spezialbohrer  
special drill bit  
broca especial

<sup>(1)</sup> Stück je Abmessung / Pieces each dimension / Piezas por diámetro



**PROFI ZIEGEL**



**Keine Ausbrüche**

Einzigartige Schneidengeometrie verhindert ein Ausbrechen der Hohlräume

**No breakoffs**

Unique cutting geometry prevents cavities from breaking off

**Sin requetrado**

La geometría de corte exclusiva impide la rotura de los huecos

**Perfekter Dübelhalt**

Durch geometrisch exakte Löcher wird ein perfekter Dübelhalt garantiert

**Perfect dowel hold**

Geometrically exact holes guarantee perfect hold of dowel

**Sujeción perfecta del taco**

Sujeción perfecta del taco garantizada gracias a los orificios con geometría exacta

**Optimale Bohrleistung für Hohlziegeln**

Bruchsicheres Drehbohren für exakte Löcher

**Optimal drilling performance for cavity bricks**

Shatter-proof rotary drilling for precise holes

**Capacidad de perforación óptima para ladrillos huecos**

Taladrado rotativo resistente a las roturas para agujeros exactos



**alpen** *drill better.*



**D Hartmetall-Hohlziegelbohrer mit zylindrischem Schaft**

**Einsatzbereich:**

Spezialbohrer zum bruchsicheren Drehbohren von Hohlziegeln. Durch einzigartige Schneidengeometrie wird ein Ausbrechen der Hohlräume verhindert und somit ein sicherer Dübelhalt gewährleistet.

**E Tungsten carbide cavity brick drill bits with cylindrical shank**

**Range of application:**

Special drill bits for shatter-proof rotary drilling of cavity bricks. The unique cutting geometry prevents the cavities from breaking and thereby ensures a secure dowel hold.

**ES Broca de metal duro para ladrillos huecos con eje cilíndrico**

**Ámbito de aplicación:**

Broca especial para el taladrado rotativo resistente a las roturas de ladrillos huecos. Gracias a la geometría de corte exclusiva se impide la rotura de los huecos y, por lo tanto, se garantiza una sujeción segura de la espiga.



Bruchsicheres Bohren / Für perfekten Dübelhalt  
Shatter-proof drilling / secure dowel hold  
Taladro a prueba de rotura / Para una sujeción de espigas perfecta



Optimale Bohrleistung durch Spezialanschliff  
Optimum drilling performance thanks to a special point shape  
Óptima potencia de taladrado gracias a su punta afilada especial



Sicher  
Secure  
Seguro



Spezialbohrer  
special drill bit  
broca especial



Oberfläche: Sonderbehandlung  
Surface: Special treatment  
Superficie: Tratamiento especial



Einzelverpackung  
Single pack  
Embalaje individual

d1 mm	d1 inch	l1 mm	l2 mm	Code 352 Art.-Nr.	Inh. Cont.	
4,00	5/32	75	39	0035200400100	1	10
5,00	3/16	85	39	0035200500100	1	10
6,00	15/64	100	54	0035200600100	1	10
8,00	5/16	120	80	0035200800100	1	10
10,00	3/8	120	80	0035201000100	1	10

**Profi Ziegel PZ 5**



5-tlg. / 5-pcs. / 5-unid.  
Kunststoffkassette / Plastic cassette / Caja de plástico  
Art.-Nr. 0000200705100

Ø mm	Stk. <sup>(1)</sup> pc. <sup>(1)</sup>
---------	---

Profi Ziegel Ø 4,00 / 5,00 / 6,00 / 8,00 / 10,00	1
---	---

<sup>(1)</sup> Stück je Abmessung / Pieces each dimension / Piezas por diámetro



## **DUST EXTRACTOR SHARP**



### **Der neue 2 in 1 Bohrer**

Bohren und Staubsaugen in einem Schritt

### **The new 2-in-1 drill bit**

Drilling and dust extraction in a single step

### **Nueva broca 2 en 1**

Perforación y aspiración en un paso

### **Saubere, staubfreie Bohrlöcher**

Erspart lästige Reinigung und ermöglicht das sichere Einsetzen chemischer Dübel

### **Clean, dust-free drill holes**

Saves annoying cleaning and enables safe insertion of chemical dowels

### **Agujeros limpios y sin polvo**

Evita el fastidio de la limpieza y permite el uso seguro de tacos químicos

### **Schützt den Anwender**

Gesundheitliche Belastungen werden vermieden

### **Protects the user**

Health risks are avoided

### **Protección del usuario**

Se evita poner en riesgo la salud



**alpen** *drill better.*

**D Hartmetall-Saugbohrer für Ziegel mit SDS-plus Schaft**

**Einsatzbereich:**

Spezialbohrer zum bruchsicheren Drehbohren von Voll- und Hohlziegeln sowie Fliesen. Durch einzigartige Schneidengeometrie wird ein Ausbrechen der Hohlräume verhindert und somit ein sicherer Dübelhalt gewährleistet.

**E Tungsten carbide extraction drill bits for bricks with SDS-plus shank**

**Range of application:**

Special drill bits for shatter-proof rotary drilling of solid and cavity bricks as well as tiles. The unique cutting geometry prevents the cavities from breaking and thereby ensures a secure dowel hold.

**ES Broca de aspiración de metal duro para ladrillos con eje SDS-plus**

**Ámbito de aplicación:**

Broca especial para el taladrado rotativo resistente a roturas de ladrillos macizos, ladrillos huecos y baldosas. Gracias a la geometría de corte exclusiva se impide la rotura de los huecos y, por lo tanto, se garantiza una sujeción segura de la espiga.



Spezialbohrer  
special drill bit  
broca especial



Bruchsicheres Bohren / Für perfekten Dübelhalt  
Shatter-proof drilling / secure dowel hold  
Taladro a prueba de rotura / Para una sujeción de espigas perfecta



Optimale Bohrleistung durch Spezialanschliff  
Optimum drilling performance thanks to a special point shape  
Óptima potencia de taladrado gracias a su punta afilada especial



Sicher  
Secure  
Segura



SB-Aufhänger  
Plastic tag  
Gancho para autoservicio

d1 mm	l1 mm	l2 mm	d2	Code 680 Art.-Nr.	Inh. Cont.	
6,00	220	100	SDS-plus	0068000600100	1	1
8,00	270	150	SDS-plus	0068000800100	1	1
10,00	270	150	SDS-plus	0068001000100	1	1
12,00	320	200	SDS-plus	0068001200100	1	1
14,00	370	250	SDS-plus	0068001400100	1	1
16,00	370	250	SDS-plus	0068001600100	1	1

**Automatische Schlag-Stopp-Funktion**  
Automatic hammer-stop function  
Función automática de parada de percusión

 **PROFI DACH**



**Für harte Materialien**

Selbst für die härtesten Dachziegel geeignet

**For hard materials**

Suitable even for the hardest roof tiles

**Para materiales duros**

Apta incluso para las tejas más duras

**Passt. Sitzt. Hält.**

Durch genormtes Schaftprofil passend für jeden Standard-Akkuschrauber

**Fits. Sits. Holds.**

Due to standardized shank profile suitable for any standard cordless drill

**Apta. Encaja. Resiste.**

Gracias a su perfil de eje conforme a la norma, es apta para todos los destornilladores a batería estándar

**Exakte Ergebnisse**

Präzisionsgeschliffene Spiralnuten sorgen für exakte Bohrungen

**Precise results**

Precision-ground spiral flutes ensure accurate holes

**Resultados exactos**

Las ranuras en espiral afiladas con precisión garantizan perforaciones exactas



 *drill better.*

**D Hartmetall-Dachziegelbohrer mit 1/4"-Sechskantschaft**

**Einsatzbereich:**

Spezialbohrer zum Drehbohren in Dachziegel, Dachstein, Eternit, Schiefer, Keramik, Fliesen, Marmor und Granit. Passend für jeden Standard-Akkuschrauber durch genormtes Schaftprofil.



Für härteste Dachziegel / Lange Lebensdauer  
For the hardest roof tiles / Long tool life  
Para las tejas más duras / Larga vida útil



Schneller Bohrfortschritt  
Fast drilling progress  
Avance de perforación rápida



Hart  
Hard  
Dura

**E Tungsten carbide roof tile drill bits with 1/4" hexagonal shank**

**Range of application:**

Special drill bits for rotary drilling in roof tiles, concrete tiles, cement asbestos, slate, ceramics, tiles, marble and granite. Suitable for all standard cordless drills with standardised shank profile.

**ES Broca de metal duro para tejas con eje hexagonal 1/4"**

**Ámbito de aplicación:**

Broca especial para el taladrado rotativo de tejas, tejas de material no cerámico, eternita, pizarra, cerámica, baldosas, mármol y granito. Adecuada para todos los destornilladores con baterías convencionales gracias al perfil de eje normativo.



Spezialbohrer  
special drill bit  
broca especial

<p><b>Oberfläche:</b> kugelgestrahlt <b>Surface:</b> GM-finish <b>Superficie:</b> GM-finish</p>					<p>Einzelverpackung Single pack Embalaje individual</p>			<p>Gewerbepack Industrial packing Paquete industrial</p>		
d1 mm	d1 inch	l1 mm	l2 mm	d2 mm	Code 252 Art.-Nr.	Inh. Cont.		Code 253 Art.-Nr.	Inh. Cont.	
3,50		100	39	1/4"	0025200350100	1	10	0025300350100	10	
4,00	5/32	100	39	1/4"	0025200400100	1	10	0025300400100	10	
5,00	3/16	100	39	1/4"	0025200500100	1	10	0025300500100	10	
6,00	15/64	100	54	1/4"	0025200600100	1	10	0025300600100	10	

 **PROFI GRANIT**



**Schnell und präzise**

Optimierte Schneidengeometrie sorgt für schnelles und präzises Arbeiten

**Fast and precise**

*Optimized cutting geometry ensures fast and precise work*

**Rápido y preciso**

*La geometría optimizada de los filos permite trabajar de forma rápida y precisa*

**Optimale Bohrmehlförderung**

durch spezielle Spiralnutgeometrie

**Optimal drilling dust transport**

*with special spiral flute geometry*

**Eliminación óptima de los detritos**

*gracias a la geometría especial de la ranura en espiral*

**Für harte Materialien**

Selbst der härteste Granit und Marmor lässt sich dank der Hartmetall-Platte exakt bohren

**For hard materials**

*Even the hardest granite and marble can be drilled accurately thanks to the carbide plate*

**Para materiales duros**

*Permite incluso la perforación del granito y del mármol más resistente gracias a su placa de metal duro*



 **alpen** *drill better.*

**D Hartmetall-Granitbohrer,  
DIN ISO 5468**

**Einsatzbereich:**

Spezialbohrer zum Dreh- und Schlagbohren von Granit und Marmor. Durch spezielle Bohrer-geometrie und Hartmetall-Platte sehr gut geeignet zum Bohren von allen Granitsorten - auch in den härtesten.



Präzise  
Precise  
Preciso



Schneller Bohrfortschritt  
Fast drilling progress  
Avance de perforación rápida



Stabil  
Stable  
Estable

**E Tungsten carbide granite drill  
bits DIN ISO 5468**

**Range of application:**

Special drill bits for rotary and percussion drilling of granite and marble. Extremely suitable for drilling all granite types with special drill bit geometry and carbide plate - even the hardest of granite.

**ES Broca de metal duro para granito,  
DIN ISO 5468**

**Ámbito de aplicación:**

Broca especial para el taladrado rotativo y a percusión de granito y mármol. Gracias a la geometría especial de la broca y la placa de metal duro es muy adecuada para taladrar cualquier tipo de granito, incluso los más duros.



Spezialbohrer  
special drill bit  
broca especial



Einzelverpackung  
Single pack  
Embalaje individual

d1 mm	d1 inch	l1 mm	l2 mm	d2	Code 257 Art.-Nr.	Inh. Cont.	
4,00	5/32	75	39		0025700400100	1	10
5,00	3/16	85	39		0025700500100	1	10
6,00	15/64	100	54		0025700600100	1	10
8,00	5/16	120	80		0025700800100	1	10
10,00	3/8	120	80		0025701000100	1	10
12,00	15/32	150	90	10,00	0025701200100	1	10
14,00	9/16	150	90	10,00	0025701400100	1	10

**Profi Granit PG 5**



5-tlg. / 5-pcs. / 5-unid.  
Kunststoffkassette / Plastic cassette / Caja de plástico  
Art.-Nr. 0025700005100

Ø mm	Stk. <sup>(1)</sup> pc. <sup>(1)</sup>
---------	---

Profi Granit

Ø 4,00 / 5,00 / 6,00 / 8,00 / 10,00	1
-------------------------------------	---

<sup>(1)</sup> Stück je Abmessung / Pieces each dimension / Piezas por diámetro

**① Hartmetall-Granitbohrer,  
DIN ISO 5468**

**Einsatzbereich:**

Spezialbohrer zum Schlagbohren von Granit und Marmor. Durch spezielle Bohrergeometrie und Hartmetall-Platte sehr gut geeignet zum Bohren von Granit.

**② Tungsten carbide granite drill  
bits DIN ISO 5468**

**Range of application:**

Special drill bits for percussion drilling of granite and marble. Extremely suitable for drilling granite with special drill bit geometry and carbide plate.

**③ Broca de metal duro para grani-  
to, DIN ISO 5468**

**Ámbito de aplicación:**

Broca especial para el taladrado a percusión de granito y mármol. Gracias a la geometría especial de la broca y la placa de metal duro es muy adecuada para taladrar el granito.



Präzise  
Precise  
Preciso



Schneller Bohrfortschritt  
Fast drilling progress  
Avance de perforación rápido



Stabil  
Stable  
Estable



Gewerbepack mit Aufhänger  
Industrial packing with tag  
Paquete industrial con gancho

d1 mm	d1 inch	l1 mm	l2 mm	d2	Code 258 Art.-Nr.	Inh. Cont.
4,00	5/32	75	39		0025800400100	10
5,00	3/16	85	39		0025800500100	10
6,00	15/64	100	54		0025800600100	10
8,00	5/16	120	80		0025800800100	10
10,00	3/8	120	80		0025801000100	10
12,00	15/32	150	90	10,00	0025801200100	5





#### **Der Problemlöser**

Präzise Ergebnisse selbst für die härtesten Feinsteinzeugfliesen

#### ***The problem solver***

*Precise results even for the hardest porcelain stoneware tiles*

#### ***La solución a los problemas***

*Resultados precisos incluso en los azulejos de gres más duros*

#### **Stabiles, bruchsicheres Bohren**

Garantiert jede Bohrung ohne Riss

#### ***Stable, shatter-proof drilling***

*Guarantees every hole without a crack*

#### ***Perforación estable resistente a las roturas***

*Garantiza perforaciones sin grietas*

#### **Einfach und exakt**

Der neue Anti-slip Schaft verhindert das Durchdrehen und sichert somit eine leichte, exakte Bohrung

#### ***Simple and precise***

*The new anti-slip shank prevents spinning and ensures easy, accurate drilling*

#### ***Fácil y preciso***

*El nuevo eje antideslizante evita la rotación y asegura una perforación fácil y precisa*

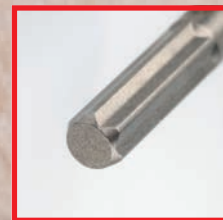

① Feinsteinzeug-Fliesenbohrer  
"C PROTECTOR"

**Einsatzbereich:**

Für extrem harte Steinzeugfliesen bis Mohs-/ Ritz-Härte 9 sowie Glas und Porzellan. Keine Kühlung erforderlich. Nicht geeignet zum Schlagbohren.

② Porcelain / gres tile drill bit  
"C PROTECTOR"

**Range of application:**

For extremely hard porcelain tiles up to Mohs / Ritz hardness 9 and glass. No cooling required. Not suitable for percussion drilling.

③ Broca para baldosas de gres  
porcelánico "C PROTECTOR"

**Ámbito de aplicación:**

Para baldosas de gres extremadamente duras con una dureza 9 de Mohs / Ritz y vidrio y porcelana. No es necesaria la refrigeración. No adecuada para el taladrado a percusión.



Punktgenaues Anbohren  
Highly accurate centering  
Perforación de gran precisión



Ideal zum Trockenbohren  
Ideal for dry drilling  
Ideal para perforaciones en seco



Anti-slip Schaft  
Anti-slip shank  
Mango anti-slip



Einzelverpackung  
Single pack  
Embalaje individual



Gewerbepack  
Industrial packing  
Paquete industrial

d1 mm	d1 inch	l1 mm	d2 mm	Code 303 Art.-Nr.	Inh. Cont.		Code 20303 Art.-Nr.	Inh. Cont.
5,00	3/16	103	10,00	0030300500100	1	10		
6,00	15/64	105	10,00	0030300600100	1	10	2030300600100	3
8,00	5/16	106	10,00	0030300800100	1	10	2030300800100	3
10,00	3/8	107		0030301000100	1	10		
12,00	15/32	110	10,00	0030301200100	1	10		

C PROTECTOR ATM 2



2-tlg. / 2-pcs. / 2-unid.  
Kunststoffkassette / Plastic cassette / Caja de plástico  
Art.-Nr. 0000303002100







Ø mm	Stk. <sup>(1)</sup> pc. <sup>(1)</sup>
C PROTECTOR Ø 14,00 / 8,00	1

Vorböhrn mit Ø 8,00 mm / To pre-drill with Ø 8,00 mm / Pretaladrado con Ø 8,00 mm  
<sup>(1)</sup> Stück je Abmessung / Pieces each dimension / Piezas por diámetro

**D** Kassetten, Sets

**E** Cassettes, sets

**ES** Cajas, juegos

<p><b>C PROTECTOR BOX 3</b></p>  <p>3-tlg. / 3-pcs. / 3-unid. Kunststoffbox / Plastic box / Caja de plástico Art.-Nr. 0000303003100</p> <table border="1"> <thead> <tr> <th>Ø mm</th> <th>Stk. (1) pc. (1)</th> </tr> </thead> <tbody> <tr> <td>C PROTECTOR</td> <td></td> </tr> <tr> <td>Ø 6,00 / 8,00 / 10,00</td> <td>1</td> </tr> </tbody> </table>	Ø mm	Stk. (1) pc. (1)	C PROTECTOR		Ø 6,00 / 8,00 / 10,00	1	<p><b>C PROTECTOR ATM 2</b></p>  <p>2-tlg. / 2-pcs. / 2-unid. Kunststoffkassette / Plastic cassette / Caja de plástico Art.-Nr. 0000303052100</p> <table border="1"> <thead> <tr> <th>Ø mm</th> <th>Stk. (1) pc. (1)</th> </tr> </thead> <tbody> <tr> <td>C PROTECTOR</td> <td></td> </tr> <tr> <td>Ø 5,00</td> <td>1</td> </tr> <tr> <td>Profi Beton</td> <td></td> </tr> <tr> <td>Ø 5,00</td> <td>1</td> </tr> </tbody> </table>	Ø mm	Stk. (1) pc. (1)	C PROTECTOR		Ø 5,00	1	Profi Beton		Ø 5,00	1	<p><b>C PROTECTOR ATM 2</b></p>  <p>2-tlg. / 2-pcs. / 2-unid. Kunststoffkassette / Plastic cassette / Caja de plástico Art.-Nr. 0000303062100</p> <table border="1"> <thead> <tr> <th>Ø mm</th> <th>Stk. (1) pc. (1)</th> </tr> </thead> <tbody> <tr> <td>C PROTECTOR</td> <td></td> </tr> <tr> <td>Ø 6,00</td> <td>1</td> </tr> <tr> <td>Profi Beton</td> <td></td> </tr> <tr> <td>Ø 6,00</td> <td>1</td> </tr> </tbody> </table>	Ø mm	Stk. (1) pc. (1)	C PROTECTOR		Ø 6,00	1	Profi Beton		Ø 6,00	1												
Ø mm	Stk. (1) pc. (1)																																							
C PROTECTOR																																								
Ø 6,00 / 8,00 / 10,00	1																																							
Ø mm	Stk. (1) pc. (1)																																							
C PROTECTOR																																								
Ø 5,00	1																																							
Profi Beton																																								
Ø 5,00	1																																							
Ø mm	Stk. (1) pc. (1)																																							
C PROTECTOR																																								
Ø 6,00	1																																							
Profi Beton																																								
Ø 6,00	1																																							
<p><b>C PROTECTOR ATM 2</b></p>  <p>2-tlg. / 2-pcs. / 2-unid. Kunststoffkassette / Plastic cassette / Caja de plástico Art.-Nr. 0000303082100</p> <table border="1"> <thead> <tr> <th>Ø mm</th> <th>Stk. (1) pc. (1)</th> </tr> </thead> <tbody> <tr> <td>C PROTECTOR</td> <td></td> </tr> <tr> <td>Ø 8,00</td> <td>1</td> </tr> <tr> <td>Profi Beton</td> <td></td> </tr> <tr> <td>Ø 8,00</td> <td>1</td> </tr> </tbody> </table>	Ø mm	Stk. (1) pc. (1)	C PROTECTOR		Ø 8,00	1	Profi Beton		Ø 8,00	1	<p><b>C PROTECTOR ATM 2</b></p>  <p>2-tlg. / 2-pcs. / 2-unid. Kunststoffkassette / Plastic cassette / Caja de plástico Art.-Nr. 0000303102100</p> <table border="1"> <thead> <tr> <th>Ø mm</th> <th>Stk. (1) pc. (1)</th> </tr> </thead> <tbody> <tr> <td>C PROTECTOR</td> <td></td> </tr> <tr> <td>Ø 10,00</td> <td>1</td> </tr> <tr> <td>Profi Beton</td> <td></td> </tr> <tr> <td>Ø 10,00</td> <td>1</td> </tr> </tbody> </table>	Ø mm	Stk. (1) pc. (1)	C PROTECTOR		Ø 10,00	1	Profi Beton		Ø 10,00	1	<p><b>KIT SET 13-1</b></p>  <p>13-tlg. / 13-pcs. / 13-unid. Set Art.-Nr. 0000303213100</p> <table border="1"> <thead> <tr> <th>Ø mm</th> <th>Stk. (1) pc. (1)</th> </tr> </thead> <tbody> <tr> <td>C PROTECTOR</td> <td></td> </tr> <tr> <td>Ø 5,00 / 6,00 / 8,00</td> <td>1</td> </tr> <tr> <td>F4 Forte</td> <td></td> </tr> <tr> <td>Ø 5,00 / 6,00 / 8,00</td> <td>1</td> </tr> <tr> <td>Profi Multicut</td> <td></td> </tr> <tr> <td>Ø 5,00 / 6,00 / 8,00</td> <td>1</td> </tr> <tr> <td>Wera</td> <td></td> </tr> <tr> <td>4 Bits sortiert / 4 Bits sorted / 4 brocas surtidas</td> <td></td> </tr> </tbody> </table>	Ø mm	Stk. (1) pc. (1)	C PROTECTOR		Ø 5,00 / 6,00 / 8,00	1	F4 Forte		Ø 5,00 / 6,00 / 8,00	1	Profi Multicut		Ø 5,00 / 6,00 / 8,00	1	Wera		4 Bits sortiert / 4 Bits sorted / 4 brocas surtidas	
Ø mm	Stk. (1) pc. (1)																																							
C PROTECTOR																																								
Ø 8,00	1																																							
Profi Beton																																								
Ø 8,00	1																																							
Ø mm	Stk. (1) pc. (1)																																							
C PROTECTOR																																								
Ø 10,00	1																																							
Profi Beton																																								
Ø 10,00	1																																							
Ø mm	Stk. (1) pc. (1)																																							
C PROTECTOR																																								
Ø 5,00 / 6,00 / 8,00	1																																							
F4 Forte																																								
Ø 5,00 / 6,00 / 8,00	1																																							
Profi Multicut																																								
Ø 5,00 / 6,00 / 8,00	1																																							
Wera																																								
4 Bits sortiert / 4 Bits sorted / 4 brocas surtidas																																								
<p><b>KIT SET 13</b></p>  <p>13-tlg. / 13-pcs. / 13-unid. Set Art.-Nr. 0000303513100</p>	<table border="1"> <thead> <tr> <th>Ø mm</th> <th>Stk. (1) pc. (1)</th> </tr> </thead> <tbody> <tr> <td>C PROTECTOR</td> <td></td> </tr> <tr> <td>Ø 6,00 / 8,00 / 10,00</td> <td>1</td> </tr> <tr> <td>FORCE X</td> <td></td> </tr> <tr> <td>Ø 6,00 / 8,00 / 10,00</td> <td>1</td> </tr> <tr> <td>Profi Multicut</td> <td></td> </tr> <tr> <td>Ø 6,00 / 8,00 / 10,00</td> <td>1</td> </tr> <tr> <td>Wera</td> <td></td> </tr> <tr> <td>4 Bits sortiert / 4 Bits sorted / 4 brocas surtidas</td> <td></td> </tr> </tbody> </table>	Ø mm	Stk. (1) pc. (1)	C PROTECTOR		Ø 6,00 / 8,00 / 10,00	1	FORCE X		Ø 6,00 / 8,00 / 10,00	1	Profi Multicut		Ø 6,00 / 8,00 / 10,00	1	Wera		4 Bits sortiert / 4 Bits sorted / 4 brocas surtidas																						
Ø mm	Stk. (1) pc. (1)																																							
C PROTECTOR																																								
Ø 6,00 / 8,00 / 10,00	1																																							
FORCE X																																								
Ø 6,00 / 8,00 / 10,00	1																																							
Profi Multicut																																								
Ø 6,00 / 8,00 / 10,00	1																																							
Wera																																								
4 Bits sortiert / 4 Bits sorted / 4 brocas surtidas																																								



Spezialbohrer  
special drill bit  
broca especial

(1) Stück je Abmessung / Pieces each dimension / Piezas por diámetro

**1 Feinsteinzeug-Fliesenbohrer**

**E Porcelain / gres tile drill bit**

**ES Broca para baldosas de gres porcelánico**

**Einsatzbereich:**

Für extrem harte Steinzeugfliesen bis Mohs-/Ritz-Härte 9 sowie Glas und Porzellan. Keine Kühlung erforderlich. Spindeldrehzahl max. 200 U/min beachten. Nicht geeignet zum Schlagbohren.

**Range of application:**

For extremely hard porcelain/gres tiles up to Mohs/Ritz hardness 9 and glass. No cooling required. Please note max. spindle speed 200 rpm. Not suitable for percussion drilling.

**Ámbito de aplicación:**

Para baldosas de gres extremadamente duras con una dureza 9 de Mohs/Ritz y vidrio y porcelana. No es necesaria la refrigeración. No superar la velocidad del husillo máxima de 200 r.p.m. No adecuada para el taladrado a percusión.



Für härteste Steinzeugfliesen bis Mohs-/Ritz-Härte 9  
For hardest porcelain/gres tiles up to Mohs/Ritz hardness 9  
Para las baldosas de gres más duras hasta una dureza de 9 en la escala Mohs



Ideal zum Trockenbohren  
Ideal for dry drilling  
Ideal para perforaciones en seco



Punktgenaues Anbohren  
Highly accurate centering  
Perforación de gran precisión



Einzelverpackung  
Single pack  
Embalaje individual



Gewerbepack  
Industrial packing  
Paquete industrial

d1 mm	d1 inch	l1 mm	d2 mm	Code 300 Art.-Nr.	Inh. Cont.		Code 20300 Art.-Nr.	Inh. Cont.
5,00	3/16	105	10,00	0030000500100	1	10		
6,00	15/64	115	10,00	0030000600100	1	10	2030000600100	3
8,00	5/16	120	10,00	0030000800100	1	10	2030000800100	3
10,00	3/8	120		0030001000100	1	10		
12,00	15/32	120	10,00	0030001200100	1	10		

**Keramo Extreme 2**



2-tlg. / 2-pcs. / 2-unid.  
Kunststoffkassette / Plastic cassette / Caja de plástico  
Art.-Nr. 0000300002100

Ø mm	Stk. <sup>(1)</sup> pc. <sup>(1)</sup>
Keramo Extreme	
Ø 14,00 / 8,00	1

Vorbohren mit Ø 8,00 mm / To pre-drill with Ø 8,00 mm / Pretaladrado con Ø 8,00 mm

<sup>(1)</sup> Stück je Abmessung / Pieces each dimension / Piezas por diámetro

**D** Kassetten, Sets

**E** Cassettes, sets

**ES** Cajas, juegos

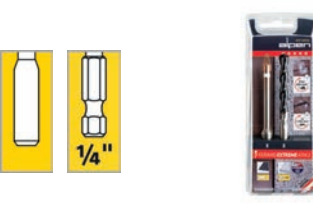
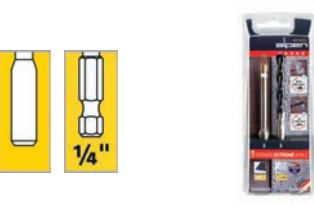
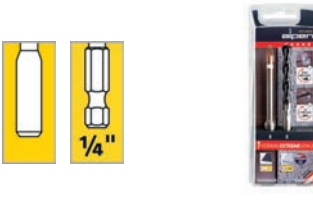
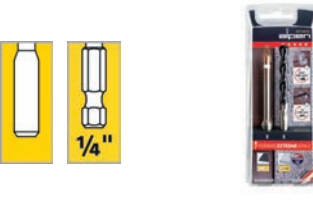
<p><b>Keramo Extreme BOX 3</b></p>  <p>3-tlg. / 3-pcs. / 3-unid. Kunststoffbox / Plastic box / Caja de plástico Art.-Nr. 0000300003100</p>		<p><b>Keramo Extreme ATM 2</b></p>  <p>2-tlg. / 2-pcs. / 2-unid. Kunststoffkassette / Plastic cassette / Caja de plástico Art.-Nr. 0000300052100</p>		<p><b>Keramo Extreme ATM 2</b></p>  <p>2-tlg. / 2-pcs. / 2-unid. Kunststoffkassette / Plastic cassette / Caja de plástico Art.-Nr. 0000300062100</p>	
Ø mm	Stk. <sup>(1)</sup> pc. <sup>(1)</sup>	Ø mm	Stk. <sup>(1)</sup> pc. <sup>(1)</sup>	Ø mm	Stk. <sup>(1)</sup> pc. <sup>(1)</sup>
Keramo Extreme	1	Keramo Extreme	1	Keramo Extreme	1
Ø 6,00 / 8,00 / 10,00		Ø 5,00	1	Ø 6,00	1
		Profi Beton		Profi Beton	
		Ø 5,00	1	Ø 6,00	1
<p><b>Keramo Extreme ATM 2</b></p>  <p>2-tlg. / 2-pcs. / 2-unid. Kunststoffkassette / Plastic cassette / Caja de plástico Art.-Nr. 0000300082100</p>		<p><b>Keramo Extreme ATM 2</b></p>  <p>2-tlg. / 2-pcs. / 2-unid. Kunststoffkassette / Plastic cassette / Caja de plástico Art.-Nr. 0000300102100</p>			
Ø mm	Stk. <sup>(1)</sup> pc. <sup>(1)</sup>	Ø mm	Stk. <sup>(1)</sup> pc. <sup>(1)</sup>		
Keramo Extreme	1	Keramo Extreme	1		
Ø 8,00		Ø 10,00	1		
Profi Beton		Profi Beton			
Ø 8,00	1	Ø 10,00	1		



Spezialbohrer  
special drill bit  
broca especial

<sup>(1)</sup> Stück je Abmessung / Pieces each dimension / Piezas por diámetro

**① Hartmetall-Keramikbohrer,  
DIN ISO 5468**

**Einsatzbereich:**

Hochleistungsbohrer zum Drehbohren von Fliesen, Keramik und Marmor. Nicht geeignet zum Schlagbohren.

**② Tungsten carbide rotary ceramic  
drill bits, DIN ISO 5468**

**Range of application:**

High efficiency drill for drilling tiles, ceramics and marble. Rotary only.

**③ Broca de metal duro para cerámica,  
DIN ISO 5468**

**Ámbito de aplicación:**

Broca de alto rendimiento para el taladrado rotativo de baldosas, cerámica y mármol. No adecuada para el taladrado a percusión.



Punktgenaues Anbohren  
Highly accurate centering  
Perforación de gran precisión



Stabil  
Stable  
Estable

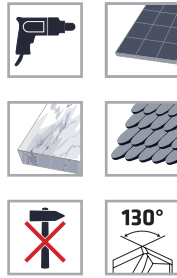

Oberfläche: Sonderbehandlung  
Surface: Special treatment  
Superficie: Tratamiento especial



Einzelverpackung  
Single pack  
Embalaje individual

d1 mm	d1 inch	l1 mm	l2 mm	d2	Code 297 Art.-Nr.	Inh. Cont.	
4,00	5/32	75	39		0029700400100	1	10
5,00	3/16	85	39		0029700500100	1	10
6,00	15/64	100	54		0029700600100	1	10
6,50	1/4	100	54	6,00	0029700650100	1	10
8,00	5/16	120	80		0029700800100	1	10
10,00	3/8	120	80		0029701000100	1	10
12,00	15/32	150	90	10,00	0029701200100	1	10

Profi Keramo KSBF 8

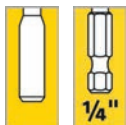

Ø mm	Stk. <sup>(1)</sup> pc. <sup>(1)</sup>
Profi Glas	
Ø 5,00 / 6,00	1
Profi Keramo	
Ø 5,00 / 10,00	1
Ø 6,00 / 8,00	2

8-tlg. / 8-pcs. / 8-unid.  
Metallkassette  
Art.-Nr. 0022700208100

<sup>(1)</sup> Stück je Abmessung / Pieces each dimension / Piezas por diámetro

**D** **Diamant-Fliesenbohrer inkl. Bohrschablone**

**Einsatzbereich:**

Für extrem harte Steinzeugfliesen, extrem harte Dachziegel, Marmor, Granit, Glas sowie Porzellan. Speziell geeignet für Akku-Bohrmaschinen und Universalhalter durch genormtes Schaftprofil. Nicht geeignet zum Schlagbohren. Unbedingt mit Wasser kühlen!



Diamantbeschichtet für härteste Materialien  
Diamond coated for the hardest materials  
Con recubrimiento de diamant para los materiales más duros

**E** **Diamond tile drill bits incl. drilling template**

**Range of application:**

For extremely hard ceramic tiles, extremely hard roofing tiles, marble, granite, glass and porcelain. Suitable for any standard cordless drill thanks to its standardized shank profile. Not suitable for percussion drilling. Water cooling highly required.



Hart  
Hard  
Dura

**ES** **Broca de diamante para baldosas, incl. plantilla para taladrar**

**Ámbito de aplicación:**

Para baldosas de gres extremadamente duros, tejas extremadamente duras, mármol, granito, vidrio y porcelana. No adecuada para el taladrado a percusión. Especialmente adecuada para taladradoras con batería y soportes universales gracias a su perfil de eje normativo. Es indispensable enfriar con agua.



Spezialbohrer  
special drill bit  
broca especial

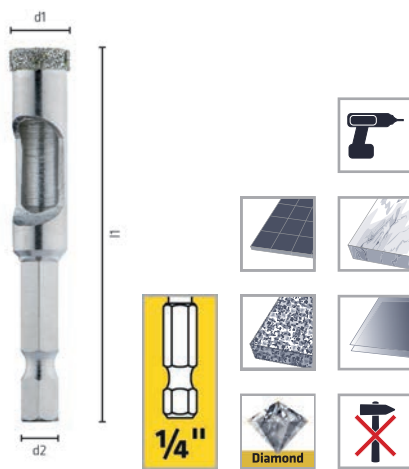

Blisterverpackung  
Blister packaging  
Embalaje en blister

d1 mm	d1 inch	l1 mm	d2 mm	Code 290 Art.-Nr.	Inh. Cont.	
5,00	3/16	60	1/4"	0029000500100	1	1
6,00	15/64	60	1/4"	0029000600100	1	1
8,00	5/16	60	1/4"	0029000800100	1	1
10,00	3/8	60	1/4"	0029001000100	1	1
12,00	15/32	60	1/4"	0029001200100	1	1
15,00	19/32	60	1/4"	0029001500100	1	1

Schaft nach DIN 3126, Form E6.3, ISO 1173 / Shank DIN 3126, Form E6.3, ISO 1173 /  
Eje según DIN 3126, forma E6.3, ISO 1173



**Inkl. Bohrschablone**  
Incl. drilling template  
Incl. plantilla para taladrar

① Hartmetall-Glasbohrer

⑤ Tungsten carbide glass drill bits ⑥ Broca de metal duro para vidrio

**Einsatzbereich:**

Zum Bohren von Glas, Flaschen, Porzellan, Fliesen usw. Nicht geeignet zum Schlagbohren.

**Range of application:**

For drilling glass, bottles, porcelain, ceramics etc. Rotary only.

**Ámbito de aplicación:**

Para el taladrado de vidrio, botellas, porcelana, baldosas, etc. No adecuada para el taladrado a percusión.



Präzise  
Precise  
Preciso



Stabil  
Stable  
Estable

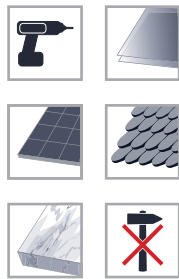

Oberfläche: kugelgestrahlt  
Surface: GM-finish  
Superficie: GM-finish

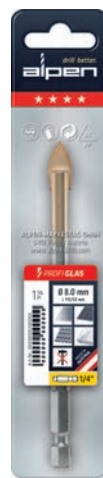

Einzelverpackung  
Single pack  
Embalaje individual

d1 mm	d1 inch	l mm	d2 mm	Code 289 Art.-Nr.	Inh. Cont.	
3,00	1/8	100	1/4"	0028900300100	1	10
4,00	5/32	100	1/4"	0028900400100	1	10
5,00	3/16	105	1/4"	0028900500100	1	10
6,00	15/64	105	1/4"	0028900600100	1	10
8,00	5/16	110	1/4"	0028900800100	1	10
10,00	3/8	130	1/4"	0028901000100	1	10
12,00	15/32	113	10,00	0028901200100	1	10



Schaft nach DIN 3126, Form E6.3, ISO 1173 / Shank DIN 3126, Form E6.3, ISO 1173 / Eje según DIN 3126, forma E6.3, ISO 1173



**D** Kassetten, Sets

**E** Cassettes, sets

**ES** Cajas, juegos

Profi Keramo KSBF 8		Profi Glas ATM 3	
			
8-tlg. / 8-pcs. / 8-unid. Metallkassette Art.-Nr. 0022700208100		3-tlg. / 3-pcs. / 3-unid. Kunststoffkassette / Plastic cassette / Caja de plástico Art.-Nr. 0028900003100	
Ø mm	Stk. <sup>(1)</sup> pc. <sup>(1)</sup>	Ø mm	Stk. <sup>(1)</sup> pc. <sup>(1)</sup>
Profi Glas		Profi Glas	
Ø 5,00 / 6,00	1	Ø 5,00 / 6,00 / 8,00	1
Profi Keramo			
Ø 5,00 / 10,00	1		
Ø 6,00 / 8,00	2		



Spezialbohrer  
special drill bit  
broca especial

<sup>(1)</sup> Stück je Abmessung / Pieces each dimension / Piezas por diámetro

**D** Drehzahlen

**E** Spindle speeds

**ES** Velocidades

Die angegebenen Schnittwertempfehlungen beziehen sich auf Standardanwendungen.

The recommended cutting data refer to standard applications.

Las recomendaciones indicadas de los valores de corte se refieren a aplicaciones estándar.

**Profi Multicut**



Code 172, 272, 729, 730, 509, 519, 529, 539, 579

Ø mm						
	U/min.   rpm   r.p.m.					
3	930	4000	1590	2100	2600	1300
4	750	3000	1200	1600	2000	1000
5	600	2400	1000	1300	1600	800
5,5	545	2185	900	1180	1450	730
6	500	2000	800	1100	1300	700
6,5	465	1850	770	1000	1230	620
7	450	1750	700	900	1150	600
8	350	1500	600	800	1000	500
10	300	1200	500	650	800	400
12	250	1000	400	550	650	350
14	200	900	350	450	550	300
16	175	750	300	400	500	250
18	165	670	280	360	450	220
20	150	600	240	320	400	200

**Profi Ziegel / DUST EXTRACTOR SHARP**



Code 352, 680

Ø mm		
	U/min.   rpm   r.p.m.	
4	3000	3000
5	2400	2400
6	2000	2000
8	1500	1500
10	1200	1200
12	1000	1000
14	900	900
16	800	800



Spezialbohrer  
special drill bit  
broca especial

Profi Dach

Profi Granit



**Code 252, 253**

Ø mm					
	U/min.	rpm	r.p.m.		
3,5	1150	700	850	1150	800
4	1000	600	750	1000	700
5	900	500	600	900	550
6	750	400	500	750	450

**Code 257**

Ø mm		
	U/min.	rpm   r.p.m.
4	2000	2400
5	1800	2000
6	1400	1700
8	1000	1250
10	800	1000
12	650	800
14	600	700

Beim Drehbohren in dünne Granitplatten  
Reduzierung der Drehzahlen um 70%.

*Please reduce spindle speeds by 70%  
if drilling into thin granite tiles.*

*Cuando taladre en placas de granito finas,  
reduzca la velocidad en un 70%.*

① Drehzahlen

② Spindle speeds

③ Velocidades

Die angegebenen Schnittwertempfehlungen beziehen sich auf Standardanwendungen.

The recommended cutting data refer to standard applications.

Las recomendaciones indicadas de los valores de corte se refieren a aplicaciones estándar.

Longlife Granit

Keramo extreme

C PROTECTOR



Code 258

Ø mm	U/min.   rpm   r.p.m.	
	U/min.	rpm   r.p.m.
4	1850	2250
5	1650	1800
6	1300	1500
8	930	1150
10	740	900
12	600	750

Code 300

Ø mm	U/min.   rpm   r.p.m.	
	U/min.	rpm   r.p.m.
5	500	500
6	400	400
8	300	300
10	300	300
12	300	300
14	200	200

Code 303

Ø mm	U/min.   rpm   r.p.m.	
	U/min.	rpm   r.p.m.
5	800	800
6	600	600
8	600	600
10	400	400
12	400	400
14	200	200



Spezialbohrer  
special drill bit  
broca especial

**Profi Keramo**

**Profi Diamant**

**Profi Glas**



**Code 297**

Ø mm	U/min.   rpm   r.p.m.		
	4	750	1600
5	600	1300	800
6	500	1100	700
6,5	450	1000	650
8	350	800	500
10	300	650	400
12	250	550	350

**Code 290**

Ø mm	U/min.   rpm   r.p.m.			
	5	1000	950	950
6	900	800	800	1300
8	700	600	600	1000
10	550	500	500	800
12	450	400	400	650
15	400	350	350	550

**Code 289**

Ø mm	U/min.   rpm   r.p.m.	
	3	400
4	300	750
5	250	600
6	200	500
8	150	350
10	100	300
12	75	250



# GESTEINSBOHRER, SDS-BOHRER UND MEISSEL

// SCHLAGBOHRER, HAMMERBOHRER, BOHRKRONEN UND MEISSEL



**E** CONCRETE AND MASONRY DRILL BITS, SDS HAMMER DRILL BITS AND CHISELS

- // PERCUSSION DRILL BITS
- // HAMMER DRILL BITS
- // CORE BITS AND CHISELS



















































**ES** BROCA PARA PIEDRA, BROCA DE PERCUSIÓN SDS Y CINCELES

- // BROCA DE PERCUSION
- // CORONAS DE PERFORAR Y CINCELES

Übersicht

Overview

Resumen































































						
Norm / Estándar	DIN ISO 5468	WN	DIN ISO 5468	WN	WN	WN
Name / Nombre	Profi Beton	Profi Beton	Long Life	FORCE X	F4 Forte	DUST EXTRACTOR SMASH
Schaft / Shank / Eje						
Ø mm	3,00 - 20,00	4,00 - 10,00	3,00 - 22,00	5,00 - 32,00	4,00 - 26,00	6,00 - 16,00
Code / Código	188, 727, 737	189	117, 118, 327, 367, 517, 617, 718	762-765, 805, 815, 825, 835, 845, 875, 905, 915	768-771, 773, 778, 807, 817, 827, 837, 847, 877, 887, 913, 914	580
Seite / Page / Página	67	69	73	79	85	93
<b>Geeignet für / Suitable for / Adecuada para</b>						
 <b>Beton</b> Concrete Hormigón						
 <b>Armierter Beton</b> Reinforced concrete Hormigón armado						
 <b>Stein</b> Natural stone Piedra						
 <b>Ziegel</b> Brick Ladrillo						
 <b>Granit</b> Granite Granito						
 <b>Marmor</b> Marble Mármol						



Übersicht

Overview

Resumen

								
WN								
SDS-plus Bohrkronen	DEMOLISHER Plus	DEMOLISHER Plus	DEMOLISHER Plus	SDS-plus Meißel	SDS-plus Meißel	SDS-plus Meißel	SDS-plus Meißel	SDS-plus Meißel
								
25,00 - 80,00								
897-899	987	987	987	982	983	985	981	984
94	95	95	95	96	96	96	96	96
								
								
								
								
								



















































Gesteinsbohrer, SDS-Bohrer und Meißel  
Concrete and Masonry drill bits, SDS hammer drill bits and chisels  
Broca para piedra, broca de percusión SDS y cinceles

Übersicht

Overview

Resumen

						
Norm / Estándar			WN	WN	WN	
Name / Nombre	SDS-plus Meißel	SDS-plus Meißel	SDS-max	SDS-max Bohrkronen	SDS-max Fräskronen	DEMOLISHER Max
Schaft / Shank / Eje						
Ø mm			12,00 - 50,00	12,00 - 125,00	45,00 - 80,00	
Code / Código	983	980	889-895	871-872	885-886	973
Seite / Page / Página	96	96	98	101	102	103
Geeignet für / Suitable for / Adecuada para						
 <b>Beton</b> Concrete Hormigón						
 <b>Armierter Beton</b> Reinforced concrete Hormigón armado						
 <b>Stein</b> Natural stone Piedra						
 <b>Ziegel</b> Brick Ladrillo						
 <b>Granit</b> Granite Granito						
 <b>Marmor</b> Marble Mármol						

Übersicht

Overview

Resumen

DEMOLISHER Max	DEMOLISHER Max	SDS-max Meißel	SDS-max Meißel	SDS-max Meißel	SDS-max Meißel	SDS-max Meißel	SDS-max Meißel	Aufnahmeadapter
973	973	978	979	971	974	970	974	996
103	103	104	104	104	104	104	104	106



Gesteinsbohrer, SDS-Bohrer und Meißel  
Concrete and Masonry drill bits, SDS hammer drill bits and chisels  
Broca para piedra, broca de percusión SDS y cinceles

 **PROFI BETON**



**Exakte Ergebnisse**

Herausragende Zentriereigenschaft ermöglicht punktgenaue Bohrungen

**Precise results**

Outstanding centering properties enable precise drilling

**Resultados exactos**

Las excelentes propiedades de centrado permiten perforaciones precisas

**Fester, sicherer Halt**

Durch vergüteten Schaft und einen hochfesten Bohrkörper wird ein stabiles Bohren ermöglicht

**Firm and stable hold**

Tempered shank and a very strong drilling core enables stable drilling

**Sujeción firme y segura**

El eje tratado y mejorado y el portabrocas de alta resistencia permiten una perforación estable

**Präzise Nuten**

Für eine optimale Bohrgutabtragung

**Precise flutes**

For optimal removal of drilling material

**Ranuras precisas**

Para una extracción óptima del material de perforación



 *drill better.*

**D Hartmetall-Betonbohrer,  
DIN ISO 5468**

**E Tungsten carbide concrete drill  
bits, DIN ISO 5468**

**ES Broca de metal duro para  
hormigón, DIN ISO 5468**

**Einsatzbereich:**

Hochleistungsbohrer Profi Beton zum Einsatz in Schlagbohrmaschinen und Bohrhämmern mit Bohrfutteraufnahme. Geeignet zum Schlagbohren in Beton, Mauerwerk und Naturstein, zum Drehbohren in Marmor.

**Range of application:**

High efficiency Profi Beton drill for percussion and heavy-duty hammer drilling of natural stone, concrete, brick and for rotary drilling of marble.

**Ámbito de aplicación:**

Broca de alto rendimiento Profi Beton para su uso en taladradoras a percusión y martillos perforadores con toma para portabrocas. Adecuada para el taladrado a percusión en hormigón, mampostería y piedra natural y para el taladrado rotativo en mármol.



Leistungsstark  
Efficient  
Alto rendimiento



Punktgenaues Anbohren  
Highly accurate centering  
Perforación de gran precisión



Stabil  
Stable  
Estable



Oberfläche: Sonderbehandlung  
Surface: Special treatment  
Superficie: Tratamiento especial

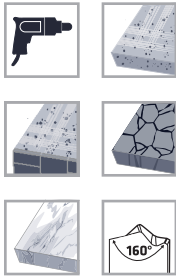

Einzelverpackung  
Single pack  
Embalaje individual

d1 mm	d1 inch	l1 mm	l2 mm	d2	Code 188 Art.-Nr.	Inh. Cont.	
3,00	1/8	60	30		0018800300100	1	10
4,00	5/32	75	39		0018800400100	1	10
5,00	3/16	85	39		0018800500100	1	10
6,00	15/64	100	54		0018800600100	1	10
6,50	1/4	100	54		0018800650100	1	10
7,00	9/32	100	54		0018800700100	1	10
8,00	5/16	120	80		0018800800100	1	10
9,00	11/32	120	80		0018800900100	1	10
10,00	3/8	120	80		0018801000100	1	10
12,00	15/32	150	90	10,00	0018801200100	1	10
14,00	9/16	150	90	10,00	0018801400100	1	10
16,00	5/8	150	90	10,00	0018801600100	1	10
18,00	23/32	160	100	10,00	0018801800100	1	10
20,00	3/4	160	100	13,00	0018802000100	1	10



Gesteinsbohrer, SDS-Bohrer und Meißel  
Concrete and Masonry drill bits, SDS hammer drill bits and chisels  
Broca para piedra, broca de percusión SDS y cinceles

Einzelverpackung  
Single pack  
Embalaje individual

Länge / Length / Longitud: 150/90 mm

d1 mm	d1 inch	l1 mm	l2 mm	Code 727 Art.-Nr.	Inh. Cont.	
5,00	3/16	150	90	0072700500100	1	10
5,50		150	90	0072700550100	1	10
6,00	15/64	150	90	0072700600100	1	10
6,50	1/4	150	90	0072700650100	1	10
7,00	9/32	150	90	0072700700100	1	10
8,00	5/16	150	90	0072700800100	1	10
10,00	3/8	150	90	0072701000100	1	10

Länge / Length / Longitud: 200/140 mm

d1 mm	d1 inch	l1 mm	l2 mm	d2	Code 737 Art.-Nr.	Inh. Cont.	
6,00	15/64	200	140		0073700600100	1	8
6,50	1/4	200	140		0073700650100	1	8
8,00	5/16	200	140		0073700800100	1	8
10,00	3/8	200	140		0073701000100	1	8
12,00	15/32	200	140	10,00	0073701200100	1	8

**D Hartmetall-Betonbohrer mit 1/4"-Sechskantschaft**

**Einsatzbereich:**

Hochleistungsbohrer speziell für Standard-Akkubohrmaschinen und Universalhalter (Bithalter) durch genormtes Schaftprofil. Zum Schlagbohren in Beton, Mauerwerk und Naturstein, zum Drehbohren in Marmor.



Leistungsstark  
Efficient  
Alto rendimiento



Punktgenaues Anbohren  
Highly accurate centering  
Perforación de gran precisión



Stabil  
Stable  
Estable

**E Tungsten carbide concrete drill bits with 1/4" hexagonal shank**

**Range of application:**

High performance drill especially for standard-cordless drills and universal holders (bit holder) through standard shank profile. For percussion drilling in concrete, brickwork and natural stone, rotary drilling in marble.

**ES Broca de metal duro para hormigón con eje hexagonal 1/4"**

**Ámbito de aplicación:**

Broca de alto rendimiento especial para taladradoras con batería estándar y soportes universales (soporte de broca) gracias a su perfil de eje normativo. Para el taladrado a percusión en hormigón, mampostería y piedra natural y el taladrado rotativo en mármol.

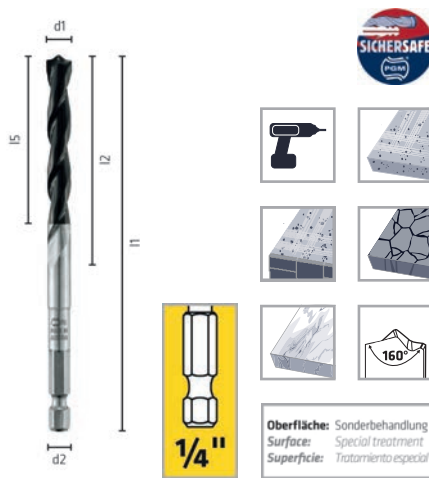

Oberfläche: Sonderbehandlung  
Surface: Special treatment  
Superficie: Tratamiento especial



Einzelverpackung  
Single pack  
Embalaje individual

d1 mm	d1 inch	l1 mm	l2 mm	l5 mm	d2	Code 189 Art.-Nr.	Inh. Cont.	
4,00	5/32	100	39	25	1/4"	0018900400100	1	10
5,00	3/16	100	39	35	1/4"	0018900500100	1	10
6,00	15/64	100	54	40	1/4"	0018900600100	1	10
8,00	5/16	120	80	55	1/4"	0018900800100	1	10
10,00	3/8	120	80	63	1/4"	0018901000100	1	10



Gesteinsbohrer, SDS-Bohrer und Meißel  
Concrete and Masonry drill bits, SDS hammer drill bits and chisels  
Broca para piedra, broca de percusión SDS y cincelos

Schaft nach DIN 3126, Form E6.3, ISO 1173 / Shank DIN 3126, Form E6.3, ISO 1173 / Eje según DIN 3126, forma E6.3, ISO 1173



















**Dübelbohrlänge**  
Drilling length for anchor  
Longitud de perforación de la espiga



**D** Kassetten, Sets

**E** Cassettes, sets

**ES** Cajas, juegos

<b>Profi Beton PTSB 5</b>  		<b>Profi Beton PKSB 8</b>  		<b>Profi Beton APTM 3</b>  	
5-tlg. / 5-pcs. / 5-unid. Kunststoffkassette / Plastic cassette / Caja de plástico Art.-Nr. 002270022100		8-tlg. / 8-pcs. / 8-unid. Kunststoffkassette / Plastic cassette / Caja de plástico Art.-Nr. 0022700201100		3-tlg. / 3-pcs. / 3-unid. Kunststoffkassette / Plastic cassette / Caja de plástico Art.-Nr. 0000101803100	
<b>Ø</b>	<b>Stk. <sup>(1)</sup></b>	<b>Ø</b>	<b>Stk. <sup>(1)</sup></b>	<b>Ø</b>	<b>Stk. <sup>(1)</sup></b>
<b>mm</b>	<b>pc. <sup>(1)</sup></b>	<b>mm</b>	<b>pc. <sup>(1)</sup></b>	<b>mm</b>	<b>pc. <sup>(1)</sup></b>
Profi Beton		Profi Beton		Profi Beton	
Ø 4,00 / 5,00 / 6,00 / 8,00 / 10,00	1	Ø 3,00 / 4,00 / 5,00 / 10,00	1	Ø 5,00 / 6,00 / 8,00	1
		Ø 6,00 / 8,00	2		
<b>C PROTECTOR ATM 2</b>  		<b>C PROTECTOR ATM 2</b>  		<b>C PROTECTOR ATM 2</b>  	
2-tlg. / 2-pcs. / 2-unid. Kunststoffkassette / Plastic cassette / Caja de plástico Art.-Nr. 0000303052100		2-tlg. / 2-pcs. / 2-unid. Kunststoffkassette / Plastic cassette / Caja de plástico Art.-Nr. 0000303062100		2-tlg. / 2-pcs. / 2-unid. Kunststoffkassette / Plastic cassette / Caja de plástico Art.-Nr. 0000303082100	
<b>Ø</b>	<b>Stk. <sup>(1)</sup></b>	<b>Ø</b>	<b>Stk. <sup>(1)</sup></b>	<b>Ø</b>	<b>Stk. <sup>(1)</sup></b>
<b>mm</b>	<b>pc. <sup>(1)</sup></b>	<b>mm</b>	<b>pc. <sup>(1)</sup></b>	<b>mm</b>	<b>pc. <sup>(1)</sup></b>
C PROTECTOR		C PROTECTOR		C PROTECTOR	
Ø 5,00	1	Ø 6,00	1	Ø 8,00	1
Profi Beton		Profi Beton		Profi Beton	
Ø 5,00	1	Ø 6,00	1	Ø 8,00	1
<b>C PROTECTOR ATM 2</b>  		<b>Keramo Extreme ATM 2</b>  		<b>Keramo Extreme ATM 2</b>  	
2-tlg. / 2-pcs. / 2-unid. Kunststoffkassette / Plastic cassette / Caja de plástico Art.-Nr. 0000303102100		2-tlg. / 2-pcs. / 2-unid. Kunststoffkassette / Plastic cassette / Caja de plástico Art.-Nr. 0000300052100		2-tlg. / 2-pcs. / 2-unid. Kunststoffkassette / Plastic cassette / Caja de plástico Art.-Nr. 0000300062100	
<b>Ø</b>	<b>Stk. <sup>(1)</sup></b>	<b>Ø</b>	<b>Stk. <sup>(1)</sup></b>	<b>Ø</b>	<b>Stk. <sup>(1)</sup></b>
<b>mm</b>	<b>pc. <sup>(1)</sup></b>	<b>mm</b>	<b>pc. <sup>(1)</sup></b>	<b>mm</b>	<b>pc. <sup>(1)</sup></b>
C PROTECTOR		Keramo Extreme		Keramo Extreme	
Ø 10,00	1	Ø 5,00	1	Ø 6,00	1
Profi Beton		Profi Beton		Profi Beton	
Ø 10,00	1	Ø 5,00	1	Ø 6,00	1



<sup>(1)</sup> Stück je Abmessung / Pieces each dimension / Piezas por diámetro



**D** Kassetten, Sets

**E** Cassettes, sets

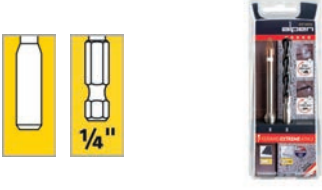
**ES** Cajas, juegos

Keramo Extreme ATM 2		Keramo Extreme ATM 2	
			
2-tlg. / 2-pcs. / 2-unid. Kunststoffkassette / Plastic cassette / Caja de plástico Art.-Nr. 0000300082100		2-tlg. / 2-pcs. / 2-unid. Kunststoffkassette / Plastic cassette / Caja de plástico Art.-Nr. 0000300102100	
Ø mm	Stk. <sup>(1)</sup> pc. <sup>(1)</sup>	Ø mm	Stk. <sup>(1)</sup> pc. <sup>(1)</sup>
Keramo Extreme		Keramo Extreme	
Ø 8,00	1	Ø 10,00	1
Profi Beton		Profi Beton	
Ø 8,00	1	Ø 10,00	1



Gesteinsbohrer, SDS-Bohrer und Meißel  
 Concrete and Masonry drill bits, SDS hammer drill bits and chisels  
 Broca para piedra, broca de percusión SDS y cinceles

<sup>(1)</sup> Stück je Abmessung / Pieces each dimension / Piezas por diámetro

 **LONG LIFE**



**Vielseitige Einsatzmöglichkeiten**

Kann als Universalbohrer flexibel eingesetzt werden

***Diverse application possibilities***

*Can be used flexibly as a universal drill*

***Múltiples posibilidades de uso***

*Se puede usar como broca universal versátil*

**Gefrästes Profil**

Wie bei den SDS-Bohrern

***Profile milled***

*As with SDS bits*

***Perfil fresado***

*Como las brocas SDS*

**Stabiler Grundkörper**

Bohrung von harten Materialien wird durch Grundkörper aus Werkzeugstahl sichergestellt

***Robust core***

*Drilling of hard materials is ensured by a core made of tool steel*

***Cuerpo base estable***

*Perforación de materiales duros asegurada gracias al cuerpo base de acero para herramientas*



 **alpen** *drill better.*

**D Hartmetall-Steinbohrer,  
DIN ISO 5468**

**Einsatzbereich:**

Universeller Mauerbohrer Typ Long Life in gefräster Ausführung zum Schlag- und Drehbohren in Mauerwerk und Naturstein.

**E Tungsten carbide masonry drill bits,  
DIN ISO 5468**

**Range of application:**

Masonry drill bit type Long Life, milled flutes, for percussion and rotary drilling in concrete, brick and natural stone.

**ES Broca de metal duro para piedra,  
DIN ISO 5468**

**Ámbito de aplicación:**

Broca universal para mampostería, tipo Long Life en modelo fresado para el taladrado a percusión y rotativo en mampostería y piedra natural.



Universeller Schlagbohrer  
Universal percussion drill bits  
Taladradora universal



Lange Lebensdauer  
Long tool life  
Larga vida útil



Hart  
Hard  
Dura



Oberfläche: kugelgestrahlt  
Surface: GM-finish  
Superficie: GM-finish







Einzelverpackung  
Single pack  
Embalaje individual



Gewerbepack mit Aufhänger  
Industrial packing with tag  
Paquete industrial con gancho

d1 mm	d1 inch	l1 mm	l2 mm	d2	Code 117 Art.-Nr.	Inh. Cont.		Code 118 Art.-Nr.	Inh. Cont.
3,00	1/8	60	30		0011700300100	1	10	0011800300100	10
4,00	5/32	75	39		0011700400100	1	10	0011800400100	10
5,00	3/16	85	39		0011700500100	1	10	0011800500100	10
5,50		85	39		0011700550100	1	10		
6,00	15/64	100	54		0011700600100	1	10	0011800600100	10
6,50	1/4	100	54		0011700650100	1	10	0011800650100	10
7,00	9/32	100	54		0011700700100	1	10		
8,00	5/16	120	80		0011700800100	1	10	0011800800100	10
9,00	11/32	120	80		0011700900100	1	10		
10,00	3/8	120	80		0011701000100	1	10	0011801000100	10
11,00	7/16	150	90	10,00	0011701100100	1	10		
12,00	15/32	150	90	10,00	0011701200100	1	10	0011801200100	10
13,00	1/2	150	90	10,00	0011701300100	1	10		
14,00	9/16	150	90	10,00	0011701400100	1	10		
15,00	19/32	150	90	10,00	0011701500100	1	10		
16,00	5/8	150	90	10,00	0011701600100	1	10		
18,00	23/32	160	100	10,00	0011701800100	1	10		
20,00	3/4	160	100	13,00	0011702000100	1	10		

Gesteinsbohrer, SDS-Bohrer und Meißel  
Concrete and Masonry drill bits, SDS hammer drill bits and chisels  
Broca para piedra, broca de percusión SDS y cinceles

					Einzelverpackung Single pack Embalaje individual			Gewerbepack mit Aufhänger Industrial packing with tag Paquete industrial con gancho	
<b>Länge / Length / Longitud: 150/90 mm</b>									
d1 mm	d1 inch	l1 mm	l2 mm		Code 718 Art.-Nr.	Inh. Cont.		Art.-Nr.	Inh. Cont.
4,00	5/32	150	90		0071800400100	1	10		
5,00	3/16	150	90		0071800500100	1	10		
5,50		150	90		0071800550100	1	10		
6,00	15/64	150	90		0071800600100	1	10		
6,50	1/4	150	90		0071800650100	1	10		
7,00	9/32	150	90		0071800700100	1	10		
8,00	5/16	150	90		0071800800100	1	10		
10,00	3/8	150	90		0071801000100	1	10		
<b>Länge / Length / Longitud: 200/140 mm</b>									
d1 mm	d1 inch	l1 mm	l2 mm	d2	Code 367 Art.-Nr.	Inh. Cont.		Art.-Nr.	Inh. Cont.
6,00	15/64	200	140		0036700600100	1	8		
8,00	5/16	200	140		0036700800100	1	8		
10,00	3/8	200	140		0036701000100	1	8		
12,00	15/32	200	140	10,00	0036701200100	1	8		
14,00	9/16	200	140	10,00	0036701400100	1	8		
16,00	5/8	200	140	10,00	0036701600100	1	8		
<b>Länge / Length / Longitud: 300/220 mm</b>									
d1 mm	d1 inch	l1 mm	l2 mm	d2	Code 327 Art.-Nr.	Inh. Cont.		Art.-Nr.	Inh. Cont.
6,00	15/64	300	220		0032700600100	1	5		
8,00	5/16	300	220		0032700800100	1	5		
10,00	3/8	300	220		0032701000100	1	5		
12,00	15/32	300	220	10,00	0032701200100	1	5		
14,00	9/16	300	220	10,00	0032701400100	1	5		
16,00	5/8	300	220	10,00	0032701600100	1	5		
18,00	23/32	300	220	10,00	0032701800100	1	5		
20,00	3/4	300	220	13,00	0032702000100	1	5		
<b>Länge / Length / Longitud: 400/300 mm</b>									
d1 mm	d1 inch	l1 mm	l2 mm	d2	Code 517 Art.-Nr.	Inh. Cont.		Art.-Nr.	Inh. Cont.
6,00	15/64	400	300		0051700600100	1	5		
6,50	1/4	400	300		0051700650100	1	5		
8,00	5/16	400	300		0051700800100	1	5		
10,00	3/8	400	300		0051701000100	1	5		
12,00	15/32	400	300	10,00	0051701200100	1	5		
13,00	1/2	400	300	10,00	0051701300100	1	5		
14,00	9/16	400	300	10,00	0051701400100	1	5		
16,00	5/8	400	300	10,00	0051701600100	1	5		
18,00	23/32	400	300	10,00	0051701800100	1	5		
20,00	3/4	400	300	13,00	0051702000100	1	5		
22,00		400	300	13,00	0051702200100	1	5		

Länge / Length / Longitud: 600/500 mm					Einzelverpackung Single pack Embalaje individual	Gewerbepack mit Aufhänger Industrial packing with tag Paquete industrial con gancho			
d1 mm	d1 inch	l1 mm	l2 mm	d2	Code 617 Art.-Nr.	Inh. Cont.		Art.-Nr.	Inh. Cont.
8,00	5/16	600	500		0061700800100	1	5		
10,00	3/8	600	500		0061701000100	1	5		
12,00	15/32	600	500	10,00	0061701200100	1	5		
14,00	9/16	600	500	10,00	0061701400100	1	5		
16,00	5/8	600	500	10,00	0061701600100	1	5		
18,00	23/32	600	500	10,00	0061701800100	1	5		
20,00	3/4	600	500	13,00	0061702000100	1	5		











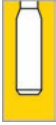



Gesteinsbohrer, SDS-Bohrer und Meißel  
Concrete and Masonry drill bits, SDS hammer drill bits and chisels  
Broca para piedra, broca de percusión SDS y cinceles

① Kassetten, Sets

② Cassettes, sets

③ Cajas, juegos

<p>Long Life TSS 3</p>  		<p>Long Life TSS 5</p>  		<p>Long Life TSS 8</p>  	
<p>3-tlg. / 3-pcs. / 3-unid. Kunststoffkassette / Plastic cassette / Caja de plástico Art.-Nr. 0000700103100</p>		<p>5-tlg. / 5-pcs. / 5-unid. Kunststoffkassette / Plastic cassette / Caja de plástico Art.-Nr. 0000700105100</p>		<p>8-tlg. / 8-pcs. / 8-unid. Kunststoffkassette / Plastic cassette / Caja de plástico Art.-Nr. 0000700108100</p>	
<b>Ø</b>	<b>Stk.<sup>(1)</sup></b>	<b>Ø</b>	<b>Stk.<sup>(1)</sup></b>	<b>Ø</b>	<b>Stk.<sup>(1)</sup></b>
<b>mm</b>	<b>pc.<sup>(1)</sup></b>	<b>mm</b>	<b>pc.<sup>(1)</sup></b>	<b>mm</b>	<b>pc.<sup>(1)</sup></b>
Long Life		Long Life		Long Life	
Ø 5,00 / 6,00 / 8,00	1	Ø 4,00 / 5,00 / 6,00 / 8,00 / 10,00	1	Ø 3,00-10,00	1
<p>KIT SET 22</p>  		<p>KIT SET 30</p>  		<p>Combiset TM 9</p>  	
<p>22-tlg. / 22-pcs. / 22-unid. Set Art.-Nr. 0000800222100</p>		<p>30-tlg. / 30-pcs. / 30-unid. Set Art.-Nr. 0000800230100</p>		<p>9-tlg. / 9-pcs. / 9-unid. Kunststoffkassette / Plastic cassette / Caja de plástico Art.-Nr. 0000802102100</p>	
<b>Ø</b>	<b>Stk.<sup>(1)</sup></b>	<b>Ø</b>	<b>Stk.<sup>(1)</sup></b>	<b>Ø</b>	<b>Stk.<sup>(1)</sup></b>
<b>mm</b>	<b>pc.<sup>(1)</sup></b>	<b>mm</b>	<b>pc.<sup>(1)</sup></b>	<b>mm</b>	<b>pc.<sup>(1)</sup></b>
Long Life		Holz		Holz	
Ø 5,00 / 6,00 / 8,00 / 10,00	1	Ø 4,00 / 5,00 / 6,00 / 8,00 / 10,00	1	Ø 5,00 / 6,00 / 8,00	1
Sprint Master		HSS Super		Long Life	
Ø 2,00 / 3,00 / 4,00 / 5,00 / 6,00 / 8,00 / 10,00	1	Ø 2,50 / 3,20	1	Ø 5,00 / 6,00 / 8,00	1
Wera		Long Life		Sprint Master	
9 Bits sortiert / 9 Bits sorted / 9 brocas surtidas		Ø 4,00 / 5,00 / 6,00 / 8,00 / 10,00	1	Ø 5,00 / 6,00 / 8,00	1
Bitshalter / Bitholder / Portabrocas		Sprint Master			
Körner / Centerpunch / Punzón		Ø 3,00 / 4,00 / 5,00 / 6,00 / 8,00 / 10,00	1		
		Wera			
		9 Bits sortiert / 9 Bits sorted / 9 brocas surtidas			
		Bitshalter / Bitholder / Portabrocas			
		Körner / Centerpunch / Punzón			

<sup>(1)</sup> Stück je Abmessung / Pieces each dimension / Piezas por diámetro

**D** Kassetten, Sets

**E** Cassettes, sets

**ES** Cajas, juegos

Combiset TM 9/1

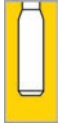

9-tlg. / 9-pcs. / 9-unid.  
Kunststoffkassette / Plastic cassette / Caja de plástico  
Art.-Nr. 0000802122100

Ø mm	Stk. <sup>(1)</sup> pc. <sup>(1)</sup>
Long Life	
Ø 4,00 / 5,00 / 6,00 / 8,00	1
Sprint Master	
Ø 3,00 / 4,00 / 5,00 / 6,00 / 8,00	1

Combiset Master SET 16



16-tlg. / 16-pcs. / 16-unid.  
Set  
Art.-Nr. 0000811003100

Ø mm	Stk. <sup>(1)</sup> pc. <sup>(1)</sup>
Holz	
Ø 4,00 / 5,00 / 6,00 / 8,00 / 10,00	1
Long Life	
Ø 4,00 / 5,00 / 6,00 / 8,00 / 10,00	1
Sprint Master	
Ø 2,00 / 3,00 / 4,00 / 5,00 / 6,00 / 8,00	1



Gesteinsbohrer, SDS-Bohrer und Meißel  
Concrete and Masonry drill bits, SDS hammer drill bits and chisels  
Broca para piedra, broca de percusión SDS y cincelos

<sup>(1)</sup> Stück je Abmessung / Pieces each dimension / Piezas por diámetro



**FORCE X**



**Kein Verhaken**

4 Vollhartmetallschneiden verhindert das Einhaken bei Armierungstreffern

**No hooking**

4 tungsten carbide cutting edges prevent hooking when hitting reinforcement

**No se engancha**

Los cuatro filos de metal duro y macizo evitan el enganche al impactar contra la armadura

**Schnell und problemlos**

Das progressive Spiralendesign liefert schnelle und exakte Ergebnisse

**Fast and trouble-free**

The progressive spiral design delivers fast and accurate results

**Rápido y sin problemas**

Su diseño en espiral proporciona resultados rápidos y precisos

**Exakte Bohrtiefe**

Durch den Einsatz von Dübellängenindikatoren

**Exact drilling depth**

Through the use of dowel length indicators

**Profundidad de perforación precisa**

Gracias al uso de un indicador de longitud de anclaje



**alpen** *drill better.*



**D** SDS-plus Hammerbohrer  
"FORCE X", 4 Schneiden

**Einsatzbereich:**

SDS-plus Hochleistungsbohrer mit 4 Vollhartmetall-Schneiden und neuem progressiven Spiralendesign mit Dübellängenindikator. Problemloses Durchbohren von Eisenarmierungen, vibrationsarmer Lauf und schnelle Bohrmehlförderung.



Für armierten Beton  
For reinforced concrete  
Para hormigón armado



4 Vollhartmetallschneiden  
4 tungsten carbide cutting edges  
4 filos de metal duro y macizo



Dübellängenindikator  
Dowel length indicator  
Indicador de longitud del anclaje

**E** SDS-plus hammer drill bits  
"FORCE X", 4 cutting edges

**Range of application:**

SDS-plus high performance drill bit with 4 tungsten carbide cutting edges and new progressive spiral design with dowel length indicator. Problem-free drilling in reinforced concrete, vibrationless running and fast removal of drilling dust.

**ES** Brocas de percusión SDS-plus  
"FORCE X", 4 filos

**Ámbito de aplicación:**

Broca SDS-plus de alto rendimiento con 4 filos de metal duro integral y una ranura diseñada de forma progresiva con indicador de longitud del anclaje. Perforación de armaduras de hierro sin problemas, taladro sin vibraciones y eliminación rápida del polvo.

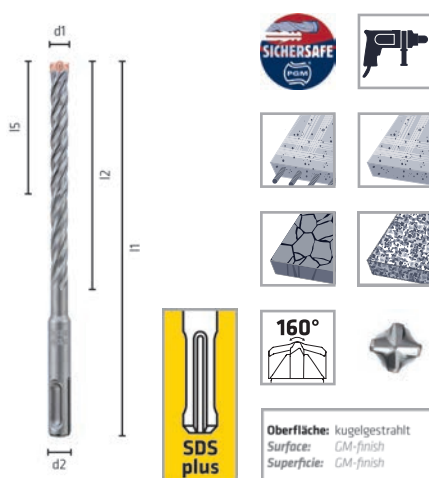

Einzelverpackung  
Single pack  
Embalaje individual



Gewerbepack  
Industrial packing  
Paquete industrial

**Länge / Length / Longitud: 110/50 mm**

d1 mm	l1 mm	l2 mm	d2	Code 805 Art.-Nr.	Inh. Cont.		Code 762 Art.-Nr.	Inh. Cont.
5,00	110	50	SDS-plus	0080500500100	1	10	0076200500100	10
5,50	110	50	SDS-plus	0080500550100	1	10		
6,00	110	50	SDS-plus	0080500600100	1	10	0076200600100	10
7,00	110	50	SDS-plus	0080500700100	1	10		
8,00	110	50	SDS-plus	0080500800100	1	10	0076200800100	10
10,00	110	50	SDS-plus	0080501000100	1	10		

**Länge / Length / Longitud: 160/100 mm**

d1 mm	l1 mm	l2 mm	l5 mm	d2	Code 815 Art.-Nr.	Inh. Cont.		Code 763 Art.-Nr.	Inh. Cont.
5,00	160	100	35	SDS-plus	0081500500100	1	10		
5,50	160	100	35	SDS-plus	0081500550100	1	10		
6,00	160	100	40	SDS-plus	0081500600100	1	10	0076300600100	10
6,50	160	100	40	SDS-plus	0081500650100	1	10		
7,00	160	100	40	SDS-plus	0081500700100	1	10		
8,00	160	100	55	SDS-plus	0081500800100	1	10	0076300800100	10
9,00	160	100	55	SDS-plus	0081500900100	1	10		
10,00	160	100	70	SDS-plus	0081501000100	1	10	0076301000100	10
12,00	160	100		SDS-plus	0081501200100	1	10	0076301200100	5
14,00	160	100		SDS-plus	0081501400100	1	10		
15,00	160	100		SDS-plus	0081501500100	1	10		
16,00	160	100		SDS-plus	0081501600100	1	10		

Gesteinsbohrer, SDS-Bohrer und Meißel  
Concrete and Masonry drill bits, SDS hammer drill bits and chisels  
Broca para piedra, broca de percusión SDS y cincelos

Einzelverpackung  
Single pack  
Embalaje individual

Gewerbepack  
Industrial packing  
Paquete industrial

Länge / Length / Longitud: 210/150 mm



d1 mm	l1 mm	l2 mm	l5 mm	d2	Code 825 Art.-Nr.	Inh. Cont.		Code 764 Art.-Nr.	Inh. Cont.
5,00	210	150	35	SDS-plus	0082500500100	1	8		
6,00	210	150	40	SDS-plus	0082500600100	1	8	0076400600100	10
6,50	210	150	40	SDS-plus	0082500650100	1	8		
8,00	210	150	55	SDS-plus	0082500800100	1	8	0076400800100	10
<b>9,00</b>	<b>210</b>	<b>150</b>	<b>55</b>	<b>SDS-plus</b>	<b>0082500900100</b>	<b>1</b>	<b>8</b>		
10,00	210	150	70	SDS-plus	0082501000100	1	8	0076401000100	10
12,00	210	150	80	SDS-plus	0082501200100	1	8	0076401200100	5
14,00	210	150	90	SDS-plus	0082501400100	1	8		
16,00	210	150	100	SDS-plus	0082501600100	1	8		

NEW

d1 mm	l1 mm	l2 mm	l5 mm	d2	Code 835 Art.-Nr.	Inh. Cont.		Code 765 Art.-Nr.	Inh. Cont.
6,00	260	200	40	SDS-plus	0083500600100	1	8	0076500600100	10
6,50	260	200	40	SDS-plus	0083500650100	1	8		
8,00	260	200	55	SDS-plus	0083500800100	1	8	0076500800100	10
9,00	260	200	55	SDS-plus	0083500900100	1	8		
10,00	260	200	70	SDS-plus	0083501000100	1	8	0076501000100	10
12,00	260	200	80	SDS-plus	0083501200100	1	8	0076501200100	5
14,00	260	200	90	SDS-plus	0083501400100	1	8	0076501400100	5
15,00	260	200	90	SDS-plus	0083501500100	1	8		
16,00	260	200	100	SDS-plus	0083501600100	1	8		
18,00	250	200		SDS-plus	0083501800100	1	8		
20,00	250	200		SDS-plus	0083502000100	1	8		
22,00	250	200		SDS-plus	0083502200100	1	8		
24,00	250	200		SDS-plus	0083502400100	1	8		
25,00	250	200		SDS-plus	0083502500100	1	8		

Länge / Length / Longitud: 310/250 mm

d1 mm	l1 mm	l2 mm	l5 mm	d2	Code 845 Art.-Nr.	Inh. Cont.		Art.-Nr.	Inh. Cont.
6,00	310	250	40	SDS-plus	0084500600100	1	8		
6,50	310	250	40	SDS-plus	0084500650100	1	8		
8,00	310	250	55	SDS-plus	0084500800100	1	8		
10,00	310	250	70	SDS-plus	0084501000100	1	8		
12,00	310	250	80	SDS-plus	0084501200100	1	8		
14,00	310	250	90	SDS-plus	0084501400100	1	8		
16,00	310	250	100	SDS-plus	0084501600100	1	8		

					Einzelverpackung <i>Single pack</i> <i>Embalaje individual</i>				Gewerbepack <i>Industrial packing</i> <i>Paquete industrial</i>
<b>Länge / Length / Longitud: 450/400 mm</b>									
d1 mm	l1 mm	l2 mm	l5 mm	d2	Code 875 Art.-Nr.	Inh. Cont.		Art.-Nr.	Inh. Cont.
8,00	450	400	55	SDS-plus	0087500800100	1	5		
10,00	450	400	70	SDS-plus	0087501000100	1	5		
12,00	450	400	80	SDS-plus	0087501200100	1	5		
14,00	450	400	90	SDS-plus	0087501400100	1	5		
16,00	450	400	100	SDS-plus	0087501600100	1	5		
18,00	450	400		SDS-plus	0087501800100	1	5		
20,00	450	400		SDS-plus	0087502000100	1	5		
22,00	450	400		SDS-plus	0087502200100	1	5		
24,00	450	400		SDS-plus	0087502400100	1	5		
25,00	450	400		SDS-plus	0087502500100	1	5		
28,00	450	400		SDS-plus	0087502800100	1	5		
30,00	450	400		SDS-plus	0087503000100	1	5		
32,00	450	400		SDS-plus	0087503200100	1	5		
<b>Länge / Length / Longitud: 600/550 mm</b>									
d1 mm	l1 mm	l2 mm	l5 mm	d2	Code 905 Art.-Nr.	Inh. Cont.		Art.-Nr.	Inh. Cont.
10,00	600	550	70	SDS-plus	0090501000100	1	5		
12,00	600	550	80	SDS-plus	0090501200100	1	5		
14,00	600	550	90	SDS-plus	0090501400100	1	5		
16,00	600	550	100	SDS-plus	0090501600100	1	5		
18,00	600	550		SDS-plus	0090501800100	1	5		
20,00	600	550		SDS-plus	0090502000100	1	5		
22,00	600	550		SDS-plus	0090502200100	1	5		



**Gesteinsbohrer, SDS-Bohrer und Meißel**  
*Concrete and Masonry drill bits, SDS hammer drill bits and chisels*  
*Broca para piedra, broca de percusión SDS y cincelos*

- > Ø 16 Ausführung ohne Dübellängenindikator und 3-tlg. Hartmetallplatte
- > Ø 16 versions without dowel length indicator and 3-piece carbide tip
- > Ø 16 Versión sin indicador de longitud de anclaje y placa de metal duro de tres piezas



**① SDS-plus Hammerbohrer  
"FORCE X", 4 Schneiden**

**Einsatzbereich:**

SDS-plus Hochleistungsbohrer mit 4 Vollhartmetall-Schneiden und neuem progressiven Spiralendesign mit Dübellängenindikator. Problemloses Durchbohren von Eisenarmierungen, vibrationsarmer Lauf und schnelle Bohrmehlförderung.



Für armierten Beton  
For reinforced concrete  
Para hormigón armado



4 Vollhartmetallschneiden  
4 tungsten carbide cutting edges  
4 filos de metal duro y macizo



Dübellängenindikator  
Dowel length indicator  
Indicador de longitud del anclaje

**② SDS-plus hammer drill bits  
"FORCE X", 4 cutting edges**

**Range of application:**

SDS-plus high performance drill bit with 4 tungsten carbide cutting edges and new progressive spiral design with dowel length indicator. Problem-free drilling in reinforced concrete, vibrationless running and fast removal of drilling dust.

**③ Brocas de percusión SDS-plus  
"FORCE X", 4 filos**

**Ámbito de aplicación:**

Broca SDS-plus de alto rendimiento con 4 filos de metal duro integral y una ranura diseñada de forma progresiva con indicador de longitud del anclaje. Perforación de armaduras de hierro sin problemas, taladro sin vibraciones y eliminación rápida del polvo.

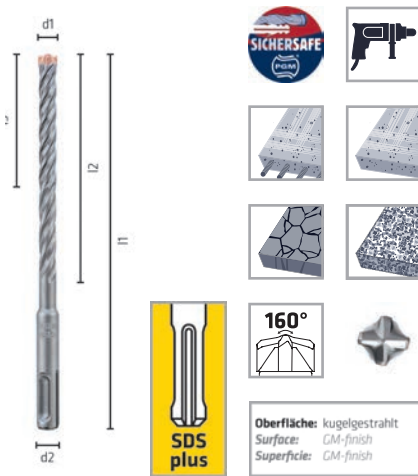

SB-Aufhänger  
Plastic tag  
Gancho para autoservicio

Länge / Length / Longitud: 1000/950 mm

d1 mm	l1 mm	l2 mm	l5 mm	d2	Code 915 Art.-Nr.	Inh. Cont.	
10,00	1000	950	70	SDS-plus	0091501000100	1	1
12,00	1000	950	80	SDS-plus	0091501200100	1	1
14,00	1000	950	90	SDS-plus	0091501400100	1	1
16,00	1000	950	100	SDS-plus	0091501600100	1	1



Dübellängenindikator  
Dowel length indicator  
Indicador de longitud del anclaje

**D** Kassetten, Sets

**E** Cassettes, sets

**ES** Cajas, juegos

<p><b>FORCE X BOX 3</b></p>   <p>3-tlg. / 3-pcs. / 3-unid. Kunststoffbox / Plastic box / Caja de plástico Art.-Nr. 0081506810100</p>	<p><b>FORCE X MB 5</b></p>   <p>5-tlg. / 5-pcs. / 5-unid. Kunststoffkassette / Plastic cassette / Caja de plástico Art.-Nr. 0080500005100</p>	<p><b>FORCE X KM 7</b></p>   <p>7-tlg. / 7-pcs. / 7-unid. Metallkassette / Metal cassette / Caja de metal Art.-Nr. 0080500007100</p>																																										
<table border="1"> <thead> <tr> <th>Ø mm</th> <th>l1 mm</th> <th>Stk.<sup>(1)</sup> pc.<sup>(1)</sup></th> </tr> </thead> <tbody> <tr> <td>FORCE X</td> <td></td> <td></td> </tr> <tr> <td>Ø 6,00 / 8,00 / 10,00</td> <td>160</td> <td>1</td> </tr> </tbody> </table>	Ø mm	l1 mm	Stk. <sup>(1)</sup> pc. <sup>(1)</sup>	FORCE X			Ø 6,00 / 8,00 / 10,00	160	1	<table border="1"> <thead> <tr> <th>Ø mm</th> <th>l1 mm</th> <th>Stk.<sup>(1)</sup> pc.<sup>(1)</sup></th> </tr> </thead> <tbody> <tr> <td>FORCE X</td> <td></td> <td></td> </tr> <tr> <td>Ø 5,00 / 6,00</td> <td>110</td> <td>1</td> </tr> <tr> <td>Ø 6,00 / 8,00 / 10,00</td> <td>160</td> <td>1</td> </tr> </tbody> </table>	Ø mm	l1 mm	Stk. <sup>(1)</sup> pc. <sup>(1)</sup>	FORCE X			Ø 5,00 / 6,00	110	1	Ø 6,00 / 8,00 / 10,00	160	1	<table border="1"> <thead> <tr> <th>Ø mm</th> <th>l1 mm</th> <th>Stk.<sup>(1)</sup> pc.<sup>(1)</sup></th> </tr> </thead> <tbody> <tr> <td>FORCE X</td> <td></td> <td></td> </tr> <tr> <td>Ø 5,00 / 6,00 / 8,00</td> <td>110</td> <td>1</td> </tr> <tr> <td>Ø 6,00 / 8,00 / 10,00 / 12,00</td> <td>160</td> <td>1</td> </tr> </tbody> </table>	Ø mm	l1 mm	Stk. <sup>(1)</sup> pc. <sup>(1)</sup>	FORCE X			Ø 5,00 / 6,00 / 8,00	110	1	Ø 6,00 / 8,00 / 10,00 / 12,00	160	1									
Ø mm	l1 mm	Stk. <sup>(1)</sup> pc. <sup>(1)</sup>																																										
FORCE X																																												
Ø 6,00 / 8,00 / 10,00	160	1																																										
Ø mm	l1 mm	Stk. <sup>(1)</sup> pc. <sup>(1)</sup>																																										
FORCE X																																												
Ø 5,00 / 6,00	110	1																																										
Ø 6,00 / 8,00 / 10,00	160	1																																										
Ø mm	l1 mm	Stk. <sup>(1)</sup> pc. <sup>(1)</sup>																																										
FORCE X																																												
Ø 5,00 / 6,00 / 8,00	110	1																																										
Ø 6,00 / 8,00 / 10,00 / 12,00	160	1																																										
<p><b>FORCE X BOX 7</b></p>   <p>7-tlg. / 7-pcs. / 7-unid. Kunststoffbox / Plastic box / Caja de plástico Art.-Nr. 0081500007100</p>	<p><b>FORCE X KP 7</b></p>   <p>7-tlg. / 7-pcs. / 7-unid. Kunststoffkassette / Plastic cassette / Caja de plástico Art.-Nr. 0080501007100</p>	<p><b>KIT SET 13</b></p>     <p>13-tlg. / 13-pcs. / 13-unid. Set Art.-Nr. 0000303513100</p>																																										
<table border="1"> <thead> <tr> <th>Ø mm</th> <th>l1 mm</th> <th>Stk.<sup>(1)</sup> pc.<sup>(1)</sup></th> </tr> </thead> <tbody> <tr> <td>FORCE X</td> <td></td> <td></td> </tr> <tr> <td>Ø 6,00 / 8,00 / 10,00</td> <td>160</td> <td>1</td> </tr> <tr> <td>Ø 6,00 / 8,00 / 10,00 / 12,00</td> <td>260</td> <td>1</td> </tr> </tbody> </table>	Ø mm	l1 mm	Stk. <sup>(1)</sup> pc. <sup>(1)</sup>	FORCE X			Ø 6,00 / 8,00 / 10,00	160	1	Ø 6,00 / 8,00 / 10,00 / 12,00	260	1	<table border="1"> <thead> <tr> <th>Ø mm</th> <th>l1 mm</th> <th>Stk.<sup>(1)</sup> pc.<sup>(1)</sup></th> </tr> </thead> <tbody> <tr> <td>FORCE X</td> <td></td> <td></td> </tr> <tr> <td>Ø 5,00 / 6,00 / 8,00</td> <td>110</td> <td>1</td> </tr> <tr> <td>Ø 6,00 / 8,00 / 10,00 / 12,00</td> <td>160</td> <td>1</td> </tr> </tbody> </table>	Ø mm	l1 mm	Stk. <sup>(1)</sup> pc. <sup>(1)</sup>	FORCE X			Ø 5,00 / 6,00 / 8,00	110	1	Ø 6,00 / 8,00 / 10,00 / 12,00	160	1	<table border="1"> <thead> <tr> <th>Ø mm</th> <th>Stk.<sup>(1)</sup> pc.<sup>(1)</sup></th> </tr> </thead> <tbody> <tr> <td>C PROTECTOR</td> <td></td> </tr> <tr> <td>Ø 6,00 / 8,00 / 10,00</td> <td>1</td> </tr> <tr> <td>FORCE X</td> <td></td> </tr> <tr> <td>Ø 6,00 / 8,00 / 10,00</td> <td>1</td> </tr> <tr> <td>Profi Multicut</td> <td></td> </tr> <tr> <td>Ø 6,00 / 8,00 / 10,00</td> <td>1</td> </tr> <tr> <td>Wera</td> <td></td> </tr> <tr> <td>4 Bits sortiert / 4 Bits sorted / 4 brocas surtidas</td> <td></td> </tr> </tbody> </table>	Ø mm	Stk. <sup>(1)</sup> pc. <sup>(1)</sup>	C PROTECTOR		Ø 6,00 / 8,00 / 10,00	1	FORCE X		Ø 6,00 / 8,00 / 10,00	1	Profi Multicut		Ø 6,00 / 8,00 / 10,00	1	Wera		4 Bits sortiert / 4 Bits sorted / 4 brocas surtidas	
Ø mm	l1 mm	Stk. <sup>(1)</sup> pc. <sup>(1)</sup>																																										
FORCE X																																												
Ø 6,00 / 8,00 / 10,00	160	1																																										
Ø 6,00 / 8,00 / 10,00 / 12,00	260	1																																										
Ø mm	l1 mm	Stk. <sup>(1)</sup> pc. <sup>(1)</sup>																																										
FORCE X																																												
Ø 5,00 / 6,00 / 8,00	110	1																																										
Ø 6,00 / 8,00 / 10,00 / 12,00	160	1																																										
Ø mm	Stk. <sup>(1)</sup> pc. <sup>(1)</sup>																																											
C PROTECTOR																																												
Ø 6,00 / 8,00 / 10,00	1																																											
FORCE X																																												
Ø 6,00 / 8,00 / 10,00	1																																											
Profi Multicut																																												
Ø 6,00 / 8,00 / 10,00	1																																											
Wera																																												
4 Bits sortiert / 4 Bits sorted / 4 brocas surtidas																																												
<p><b>SDS-plus FORCE X KIT SET 16</b></p>   <p>16-tlg. / 16-pcs. / 16-unid. Set Art.-Nr. 0000500216100</p>	<table border="1"> <thead> <tr> <th>Inhalt Contents / Contenido</th> <th>l1 mm</th> <th>Stk.<sup>(1)</sup> pc.<sup>(1)</sup></th> </tr> </thead> <tbody> <tr> <td>Bohrer / Drill bits / Broca:</td> <td></td> <td></td> </tr> <tr> <td>Ø 5,00 / 6,00</td> <td>110</td> <td>1</td> </tr> <tr> <td>Ø 6,00 / 8,00 / 10,00 / 12,00</td> <td>160</td> <td>1</td> </tr> <tr> <td>Ø 6,00 / 8,00 / 10,00</td> <td>210</td> <td>1</td> </tr> <tr> <td>Ø 8,00 / 10,00 / 12,00 / 14,00</td> <td>260</td> <td>1</td> </tr> <tr> <td>Meißel / Chisel / Cíncel:</td> <td></td> <td></td> </tr> <tr> <td>Spitz / point / punta</td> <td></td> <td>1</td> </tr> <tr> <td>Flach / flat / plana</td> <td></td> <td>1</td> </tr> <tr> <td>Breit / wide / ancha</td> <td></td> <td>1</td> </tr> </tbody> </table>		Inhalt Contents / Contenido	l1 mm	Stk. <sup>(1)</sup> pc. <sup>(1)</sup>	Bohrer / Drill bits / Broca:			Ø 5,00 / 6,00	110	1	Ø 6,00 / 8,00 / 10,00 / 12,00	160	1	Ø 6,00 / 8,00 / 10,00	210	1	Ø 8,00 / 10,00 / 12,00 / 14,00	260	1	Meißel / Chisel / Cíncel:			Spitz / point / punta		1	Flach / flat / plana		1	Breit / wide / ancha		1												
Inhalt Contents / Contenido	l1 mm	Stk. <sup>(1)</sup> pc. <sup>(1)</sup>																																										
Bohrer / Drill bits / Broca:																																												
Ø 5,00 / 6,00	110	1																																										
Ø 6,00 / 8,00 / 10,00 / 12,00	160	1																																										
Ø 6,00 / 8,00 / 10,00	210	1																																										
Ø 8,00 / 10,00 / 12,00 / 14,00	260	1																																										
Meißel / Chisel / Cíncel:																																												
Spitz / point / punta		1																																										
Flach / flat / plana		1																																										
Breit / wide / ancha		1																																										



Gesteinsbohrer, SDS-Bohrer und Meißel  
Concrete and Masonry drill bits, SDS hammer drill bits and chisels  
Broca para piedra, broca de percusión SDS y cíncelos

<sup>(1)</sup> Stück je Abmessung / Pieces each dimension / Piezas por diámetro



**F4 FORTE**



**Schnell und präzise**

Trotz schneller Bohrung entstehen exakte Dübellöcher

**Fast and precise**

Accurate dowel holes are created despite fast drilling

**Rápido y preciso**

Agujeros para el taco precisos a pesar de la rapidez de perforación

**Exzellente Zentriereigenschaften**

Dank dem Einsatz einer patentierten Hartmetallplatte

**Excellent centering properties**

Thanks to the use of a patented carbide tip

**Excelentes propiedades de centrado**

Gracias al uso de una placa de metal duro patentada

**Schnelle Bohrmehlförderung**

Aufgrund des patentierten 4-fach Stufenprofils

**Fast drill dust feed**

Due to the patented 4-step profile

**Extracción rápida del polvo**

gracias al perfil cuádruple escalonado patentado



**alpen** *drill better.*

**D** SDS-plus Hammerbohrer „F4“, 2 Schneiden **E** SDS-plus hammer drill bits “F4”, 2 cutting edges **ES** Brocas de percusión SDS-plus “F4”, 2 filos

**Einsatzbereich:**

Der SDS-plus Hammerbohrer F4 mit patentiertem 4-fach-Stufenprofil und patentierter Hartmetallplatte. Geringer Verschleiß, sehr hohe Standzeit. Hochleistungsbohrer zum Hammerbohren in Beton, Naturstein und Mauerwerk.

**Range of application:**

The SDS-plus hammer drill bit F4 with its patented 4X stepped profile and patented tip. Low wear, very long service life. High efficiency drill bit for heavy-duty drilling in concrete, natural stone and brickwork.

**Ámbito de aplicación:**

La broca de percusión SDS-plus F4 con perfil cuádruple escalonado patentado y plancha de metal duro patentada. Menor desgaste, largo tiempo de uso. Broca de alto rendimiento para taladrado a percusión en hormigón, piedra natural y mampostería.



Leistungsstark  
Efficient  
Alto rendimiento



Schneller Bohrfortschritt  
Fast drilling progress  
Avance de perforación rápido



Präzise  
Precise  
Preciso

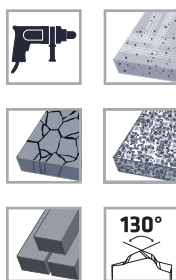

Oberfläche: kugelgestrahlt  
Surface: GM-finish  
Superficie: GM-finish



Einzelverpackung  
Single pack  
Embalaje individual





Gewerbepack  
Industrial packing  
Paquete industrial



Länge / Length / Longitud: 110/50 mm

d1 mm	l1 mm	l2 mm	d2	Code 807 Art.-Nr.	Inh. Cont.		Code 768 Art.-Nr.	Inh. Cont.
4,00	110	50	SDS-plus	0080700400100	1	10	0076800400100	10
5,00	110	50	SDS-plus	0080700500100	1	10	0076800500100	10
5,50	110	50	SDS-plus	0080700550100	1	10	0076800550100	10
6,00	110	50	SDS-plus	0080700600100	1	10	0076800600100	10
6,50	110	50	SDS-plus	0080700650100	1	10	0076800650100	10
7,00	110	50	SDS-plus	0080700700100	1	10	0076800700100	10
8,00	110	50	SDS-plus	0080700800100	1	10	0076800800100	10
10,00	110	50	SDS-plus	0080701000100	1	10	0076801000100	10

Gesteinsbohrer, SDS-Bohrer und Meißel  
Concrete and Masonry drill bits, SDS hammer drill bits and chisels  
Broca para piedra, broca de percusión SDS y cinceles



				Einzelverpackung <i>Single pack</i> <i>Embalaje individual</i>			Gewerbepack <i>Industrial packing</i> <i>Paquete industrial</i>	
Länge / Length / Longitud: 160/100 mm								
d1 mm	l1 mm	l2 mm	d2	Code 817 Art.-Nr.	Inh. Cont.		Code 769 Art.-Nr.	Inh. Cont.
4,00	160	100	SDS-plus	0081700400100	1	10	0076900400100	10
5,00	160	100	SDS-plus	0081700500100	1	10	0076900500100	10
5,50	160	100	SDS-plus	0081700550100	1	10	0076900550100	10
6,00	160	100	SDS-plus	0081700600100	1	10	0076900600100	10
6,50	160	100	SDS-plus	0081700650100	1	10	0076900650100	10
7,00	160	100	SDS-plus	0081700700100	1	10	0076900700100	10
8,00	160	100	SDS-plus	0081700800100	1	10	0076900800100	10
9,00	160	100	SDS-plus	0081700900100	1	10	0076900900100	10
9,50	160	100	SDS-plus	0081700950100	1	10		
10,00	160	100	SDS-plus	0081701000100	1	10	0076901000100	10
11,00	160	100	SDS-plus	0081701100100	1	10		
12,00	160	100	SDS-plus	0081701200100	1	10	0076901200100	5
13,00	160	100	SDS-plus	0081701300100	1	10		
14,00	160	100	SDS-plus	0081701400100	1	10	0076901400100	5
15,00	160	100	SDS-plus	0081701500100	1	10	0076901500100	5
16,00	160	100	SDS-plus	0081701600100	1	10	0076901600100	5
Länge / Length / Longitud: 210/150 mm								
d1 mm	l1 mm	l2 mm	d2	Code 827 Art.-Nr.	Inh. Cont.		Code 770 Art.-Nr.	Inh. Cont.
5,00	210	150	SDS-plus	0082700500100	1	8	0077000500100	10
5,50	210	150	SDS-plus	0082700550100	1	8	0077000550100	10
6,00	210	150	SDS-plus	0082700600100	1	8	0077000600100	10
6,50	210	150	SDS-plus	0082700650100	1	8	0077000650100	10
7,00	210	150	SDS-plus	0082700700100	1	8	0077000700100	10
8,00	210	150	SDS-plus	0082700800100	1	8	0077000800100	10
9,00	210	150	SDS-plus	0082700900100	1	8	0077000900100	10
10,00	210	150	SDS-plus	0082701000100	1	8	0077001000100	10
12,00	210	150	SDS-plus	0082701200100	1	8	0077001200100	5
14,00	210	150	SDS-plus	0082701400100	1	8	0077001400100	5
15,00	210	150	SDS-plus	0082701500100	1	8	0077001500100	5
16,00	210	150	SDS-plus	0082701600100	1	8	0077001600100	5
17,00	210	150	SDS-plus	0082701700100	1	8		
18,00	210	150	SDS-plus	0082701800100	1	8		
19,00	210	150	SDS-plus	0082701900100	1	8		
20,00	210	150	SDS-plus	0082702000100	1	8		



				Einzelverpackung <i>Single pack</i> <i>Embalaje individual</i>			Gewerbepack <i>Industrial packing</i> <i>Paquete industrial</i>	
Länge / Length / Longitud: 260/200 mm								
d1 mm	l1 mm	l2 mm	d2	Code 837 Art.-Nr.	Inh. Cont.		Code 771 Art.-Nr.	Inh. Cont.
5,00	260	200	SDS-plus	0083700500100	1	8		
5,50	260	200	SDS-plus	0083700550100	1	8		
6,00	260	200	SDS-plus	0083700600100	1	8	0077100600100	10
6,50	260	200	SDS-plus	0083700650100	1	8	0077100650100	10
7,00	260	200	SDS-plus	0083700700100	1	8	0077100700100	10
8,00	260	200	SDS-plus	0083700800100	1	8	0077100800100	10
10,00	260	200	SDS-plus	0083701000100	1	8	0077101000100	10
11,00	260	200	SDS-plus	0083701100100	1	8		
12,00	260	200	SDS-plus	0083701200100	1	8	0077101200100	5
13,00	260	200	SDS-plus	0083701300100	1	8		
14,00	260	200	SDS-plus	0083701400100	1	8	0077101400100	5
15,00	260	200	SDS-plus	0083701500100	1	8	0077101500100	5
16,00	260	200	SDS-plus	0083701600100	1	8	0077101600100	5
18,00	260	200	SDS-plus	0083701800100	1	8		
20,00	260	200	SDS-plus	0083702000100	1	8		
22,00	260	200	SDS-plus	0083702200100	1	8		
24,00	260	200	SDS-plus	0083702400100	1	8		
25,00	260	200	SDS-plus	0083702500100	1	8		
26,00	260	200	SDS-plus	0083702600100	1	8		
Länge / Length / Longitud: 310/250 mm								
d1 mm	l1 mm	l2 mm	d2	Code 847 Art.-Nr.	Inh. Cont.		Code 773 Art.-Nr.	Inh. Cont.
5,00	310	250	SDS-plus	0084700500100	1	8		
5,50	310	250	SDS-plus	0084700550100	1	8		
6,00	310	250	SDS-plus	0084700600100	1	8	0077300600100	10
6,50	310	250	SDS-plus	0084700650100	1	8		
7,00	310	250	SDS-plus	0084700700100	1	8	0077300700100	10
8,00	310	250	SDS-plus	0084700800100	1	8	0077300800100	10
10,00	310	250	SDS-plus	0084701000100	1	8	0077301000100	10
12,00	310	250	SDS-plus	0084701200100	1	8	0077301200100	5
13,00	310	250	SDS-plus	0084701300100	1	8		
14,00	310	250	SDS-plus	0084701400100	1	8	0077301400100	5
16,00	310	250	SDS-plus	0084701600100	1	8	0077301600100	5
18,00	310	250	SDS-plus	0084701800100	1	8		
19,00	310	250	SDS-plus	0084701900100	1	8		
20,00	310	250	SDS-plus	0084702000100	1	8		
22,00	310	250	SDS-plus	0084702200100	1	8		
24,00	310	250	SDS-plus	0084702400100	1	8		
25,00	310	250	SDS-plus	0084702500100	1	8		



Gesteinsbohrer, SDS-Bohrer und Meißel  
Concrete and Masonry drill bits, SDS hammer drill bits and chisels  
Broca para piedra, broca de percusión SDS y cincelos

				Einzelverpackung <i>Single pack</i> <i>Embalaje individual</i>			Gewerbepack <i>Industrial packing</i> <i>Paquete industrial</i>	
d1 mm	l1 mm	l2 mm	d2	Code 877 Art.-Nr.	Inh. Cont.		Code 778 Art.-Nr.	Inh. Cont.
5,00	450	400	SDS-plus	0087700500100	1	5		
5,50	450	400	SDS-plus	0087700550100	1	5		
6,00	450	400	SDS-plus	0087700600100	1	5	0077800600100	10
6,50	450	400	SDS-plus	0087700650100	1	5		
8,00	450	400	SDS-plus	0087700800100	1	5	0077800800100	10
10,00	450	400	SDS-plus	0087701000100	1	5	0077801000100	10
12,00	450	400	SDS-plus	0087701200100	1	5	0077801200100	5
13,00	450	400	SDS-plus	0087701300100	1	5		
14,00	450	400	SDS-plus	0087701400100	1	5	0077801400100	5
15,00	450	400	SDS-plus	0087701500100	1	5		
16,00	450	400	SDS-plus	0087701600100	1	5	0077801600100	5
18,00	450	300	SDS-plus	0087701800100	1	5		
20,00	450	400	SDS-plus	0087702000100	1	5		
22,00	450	400	SDS-plus	0087702200100	1	5		
24,00	450	400	SDS-plus	0087702400100	1	5		
25,00	450	400	SDS-plus	0087702500100	1	5		
26,00	450	400	SDS-plus	0087702600100	1	5		
<b>Länge / Length / Longitud: 600/550 mm</b>								
d1 mm	l1 mm	l2 mm	d2	Code 887 Art.-Nr.	Inh. Cont.		Art.-Nr.	Inh. Cont.
10,00	600	550	SDS-plus	0088701000100	1	5		
12,00	600	550	SDS-plus	0088701200100	1	5		
14,00	600	550	SDS-plus	0088701400100	1	5		
16,00	600	550	SDS-plus	0088701600100	1	5		
18,00	600	550	SDS-plus	0088701800100	1	5		
20,00	600	550	SDS-plus	0088702000100	1	5		
24,00	600	550	SDS-plus	0088702400100	1	5		
25,00	600	550	SDS-plus	0088702500100	1	5		

**D** SDS-plus Hammerbohrer „F4“, 2 Schneiden

**E** SDS-plus hammer drill bits “F4”, 2 cutting edges

**ES** Brocas de percusión SDS-plus “F4”, 2 filos

**Einsatzbereich:**

Der SDS-plus Hammerbohrer F4 mit patentiertem 4-fach-Stufenprofil und patentierter Hartmetallplatte. Geringer Verschleiß, sehr hohe Standzeit. Hochleistungsbohrer zum Hammerbohren in Beton, Naturstein und Mauerwerk.

**Range of application:**

The SDS-plus hammer drill bit F4 with its patented 4X stepped profile and patented tip. Low wear, very long service life. High efficiency drill bit for heavy-duty drilling in concrete, natural stone and brickwork.

**Ámbito de aplicación:**

La broca de percusión SDS-plus F4 con perfil cuádruple escalonado patentado y plancha de metal duro patentada. Menor desgaste, largo tiempo de uso. Broca de alto rendimiento para taladrado a percusión en hormigón, piedra natural y mampostería.



Leistungsstark  
Efficient  
Alto rendimiento



Schneller Bohrfortschritt  
Fast drilling progress  
Avance de perforación rápido



Präzise  
Precise  
Preciso

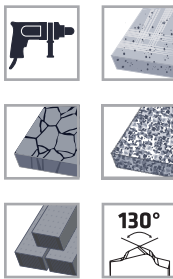

Oberfläche: kugelgestrahlt  
Surface: GM-finish  
Superficie: GM-finish



SB-Aufhänger  
Plastic tag  
Gancho para autoservicio

**Länge / Length / Longitud: 800/740 mm**

d1 mm	l1 mm	l2 mm	d2	Code 913 Art.-Nr.	Inh. Cont.	
12,00	800	740	SDS-plus	0091301200100	1	1
16,00	800	740	SDS-plus	0091301600100	1	1
20,00	800	740	SDS-plus	0091302000100	1	1

**Länge / Length / Longitud: 1000/950 mm**

d1 mm	l1 mm	l2 mm	d2	Code 914 Art.-Nr.	Inh. Cont.	
10,00	1000	950	SDS-plus	0091401000100	1	1
12,00	1000	950	SDS-plus	0091401200100	1	1
14,00	1000	950	SDS-plus	0091401400100	1	1
16,00	1000	950	SDS-plus	0091401600100	1	1
18,00	1000	950	SDS-plus	0091401800100	1	1
20,00	1000	950	SDS-plus	0091402000100	1	1
25,00	1000	950	SDS-plus	0091402500100	1	1











Gesteinsbohrer, SDS-Bohrer und Meißel  
Concrete and Masonry drill bits, SDS hammer drill bits and chisels  
Broca para piedra, broca de percusión SDS y cinceles

**D** Kassetten, Sets

**E** Cassettes, sets

**ES** Cajas, juegos

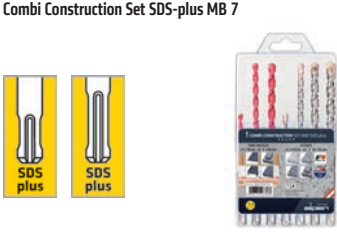
<p>F4 Forte BOX 3</p>  <p>3-tlg. / 3-pcs. / 3-unid. Kunststoffbox / Plastic box / Caja de plástico Art.-Nr. 0081700568100</p>			<p>F4 Forte BOX 3</p>  <p>3-tlg. / 3-pcs. / 3-unid. Kunststoffbox / Plastic box / Caja de plástico Art.-Nr. 0081700571100</p>			<p>F4 Forte MB 5</p>  <p>5-tlg. / 5-pcs. / 5-unid. Kunststoffkassette / Plastic cassette / Caja de plástico Art.-Nr. 0080705680100</p>		
<b>Ø</b> mm	<b>l1</b> mm	<b>Stk.</b> <sup>(1)</sup> <b>pc.</b> <sup>(1)</sup>	<b>Ø</b> mm	<b>l1</b> mm	<b>Stk.</b> <sup>(1)</sup> <b>pc.</b> <sup>(1)</sup>	<b>Ø</b> mm	<b>l1</b> mm	<b>Stk.</b> <sup>(1)</sup> <b>pc.</b> <sup>(1)</sup>
F4 Forte			F4 Forte			F4 Forte		
Ø 5,00 / 6,00 / 8,00	160	1	Ø 6,00 / 7,00 / 10,00	160	1	Ø 5,00 / 6,00	110	1
						Ø 6,00 / 8,00 / 10,00	160	1
<p>F4 Forte MB 7</p>  <p>7-tlg. / 7-pcs. / 7-unid. Kunststoffkassette / Plastic cassette / Caja de plástico Art.-Nr. 0080700007100</p>			<p>F4 Forte SET 8</p>  <p>8-tlg. / 8-pcs. / 8-unid. Set Art.-Nr. 0080704100100</p>			<p>F4 Forte KM 7</p>  <p>7-tlg. / 7-pcs. / 7-unid. Metallkassette / Metal cassette / Caja de metal Art.-Nr. 0000500007100</p>		
<b>Ø</b> mm	<b>l1</b> mm	<b>Stk.</b> <sup>(1)</sup> <b>pc.</b> <sup>(1)</sup>	<b>Ø</b> mm	<b>l1</b> mm	<b>Stk.</b> <sup>(1)</sup> <b>pc.</b> <sup>(1)</sup>	<b>Ø</b> mm	<b>l1</b> mm	<b>Stk.</b> <sup>(1)</sup> <b>pc.</b> <sup>(1)</sup>
F4 Forte			F4 Forte			F4 Forte		
Ø 5,00 / 6,00	110	1	Ø 5,00 / 6,00 / 8,00	110	1	Ø 5,00 / 6,00 / 8,00	110	1
Ø 6,00 / 7,00 / 8,00 / 9,00 / 10,00	160	1	Ø 6,00 / 8,00 / 10,00 / 12,00	160	1	Ø 6,00 / 8,00 / 10,00 / 12,00	160	1
			Ø 8,00	210	1			
<p>F4 Forte BOX 5</p>  <p>5-tlg. / 5-pcs. / 5-unid. Kunststoffbox / Plastic box / Caja de plástico Art.-Nr. 10077809005100</p>			<p>F4 Forte BOX 5</p>  <p>5-tlg. / 5-pcs. / 5-unid. Kunststoffbox / Plastic box / Caja de plástico Art.-Nr. 10088709005100</p>			<p>Combi Construction Set SDS-plus MB 7</p>  <p>7-tlg. / 7-pcs. / 7-unid. Kunststoffkassette / Plastic cassette / Caja de plástico Art.-Nr. 0000100007100</p>		
<b>Ø</b> mm	<b>l1</b> mm	<b>Stk.</b> <sup>(1)</sup> <b>pc.</b> <sup>(1)</sup>	<b>Ø</b> mm	<b>l1</b> mm	<b>Stk.</b> <sup>(1)</sup> <b>pc.</b> <sup>(1)</sup>	<b>Ø</b> mm	<b>l1</b> mm	<b>Stk.</b> <sup>(1)</sup> <b>pc.</b> <sup>(1)</sup>
F4 Forte			F4 Forte			F4 Forte		
Ø 10,00 / 12,00 / 14,00 / 16,00 / 20,00	450	1	Ø 10,00 / 12,00 / 14,00 / 16,00 / 20,00	600	1	Ø 5,00	110	1
						Ø 6,00 / 8,00 / 10,00	160	1
						Profi Multicut		
						Ø 5,00	110	1
						Ø 6,00 / 8,00	160	1

<sup>(1)</sup> Stück je Abmessung / Pieces each dimension / Piezas por diámetro

**D** Kassetten, Sets

**E** Cassettes, sets

**ES** Cajas, juegos

<p><b>KIT SET 13-1</b></p>  <p>13-tlg. / 13-pcs. / 13-unid. Set Art.-Nr. 0000303213100</p>			<p><b>SDS-plus F4 Forte Mix BOX 8</b></p>  <p>8-tlg. / 8-pcs. / 8-unid. Kunststoffbox / Plastic box / Caja de plástico Art.-Nr. 0000500008100</p>			<p><b>SDS-plus F4 Forte KIT SET 16</b></p>  <p>16-tlg. / 16-pcs. / 16-unid. Set Art.-Nr. 0000500016100</p>		
Ø mm	Stk. <sup>(1)</sup> pc. <sup>(1)</sup>	Inhalt Contents / Contenido	l1 mm	Stk. <sup>(1)</sup> pc. <sup>(1)</sup>	Inhalt Contents / Contenido	l1 mm	Stk. <sup>(1)</sup> pc. <sup>(1)</sup>	
C PROTECTOR		Bohrer / Drill bits / Broca:			Bohrer / Drill bits / Broca:			
Ø 5,00 / 6,00 / 8,00	1	Ø 6,00 / 8,00 / 10,00 / 12,00	160	1	Ø 5,00 / 6,00	110	1	
F4 Forte		Ø 8,00 / 10,00	210	1	Ø 6,00 / 8,00 / 10,00 / 12,00	160	1	
Ø 5,00 / 6,00 / 8,00	1	Meißel / Chisel / Cincel:			Ø 6,00 / 8,00 / 10,00	210	1	
Profi Multicut		Spitz / point / punta		1	Ø 8,00 / 10,00 / 12,00 / 14,00	260	1	
Ø 5,00 / 6,00 / 8,00	1	Flach / flat / plana		1	Meißel / Chisel / Cincel:			
Wera					Spitz / point / punta		1	
4 Bits sortiert / 4 Bits sorted / 4 brocas surtidas					Flach / flat / plana		1	
					Breit / wide / ancha		1	
<p><b>SDS-plus Mix Set F4 Forte KM 6</b></p>  <p>6-tlg. / 6-pcs. / 6-unid. Metallkassette / Metal cassette / Caja de metal Art.-Nr. 0081700006100</p>								
Ø mm	l1 mm	Stk. <sup>(1)</sup> pc. <sup>(1)</sup>						
F4 Forte								
Ø 5,00 / 6,00 / 8,00 / 10,00	160	1						
Meißel / Chisel / Cincel:								
Spitz / point / punta	140	1						
Flach / flat / plana	20 x 140	1						



Gesteinsbohrer, SDS-Bohrer und Meißel  
 Concrete and Masonry drill bits, SDS hammer drill bits and chisels  
 Broca para piedra, broca de percusión SDS y cincelos

<sup>(1)</sup> Stück je Abmessung / Pieces each dimension / Piezas por diámetro



## DUST EXTRACTOR SMASH



### **Der neue 2 in 1 Bohrer**

Bohren und Staubsaugen in einem Schritt

### **The new 2-in-1 drill bit**

Drilling and dust extraction in a single step

### **Nueva broca 2 en 1**

Perforación y aspiración en un paso

### **Saubere, staubfreie Bohrlöcher**

Erspart lästige Reinigung und ermöglicht das sichere Einsetzen chemischer Dübel

### **Clean, dust-free drill holes**

Saves annoying cleaning and enables safe insertion of chemical dowels

### **Agujeros limpios y sin polvo**

Evita el fastidio de la limpieza y permite el uso seguro de tacos químicos

### **Schützt den Anwender**

Gesundheitliche Belastungen werden vermieden

### **Protects the user**

Health risks are avoided

### **Protección del usuario**

Se evita poner en riesgo la salud

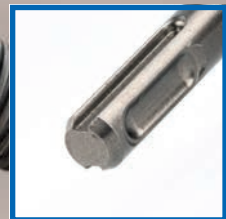

**D** SDS-plus Saugbohrer  
„DUST EXTRACTOR SMASH“  
2 Schneiden

**Einsatzbereich:**

Der SDS-plus Hammerbohrer zum Saugbohren mit geringem Verschleiß und sehr hoher Standzeit. Hochleistungsbohrer zum Hammerbohren in Beton, Naturstein und Mauerwerk.



Leistungsstark  
Efficient  
Alto rendimiento



Schneller Bohrfortschritt  
Fast drilling progress  
Avance de perforación rápida



Präzise  
Precise  
Preciso

**E** SDS-plus extraction drill bits  
„DUST EXTRACTOR SMASH“  
2 cutting edges

**Range of application:**

The SDS-plus hammer drill bit for extraction drilling with low wear and very long service life. High efficiency drill bit for heavy-duty drilling in concrete, natural stone and brick-work.

**ES** Broca de aspiración SDS-plus  
„DUST EXTRACTOR SMASH“  
2 filos

**Ámbito de aplicación:**

La broca SDS-plus para perforar a percusión aspirando el polvo con desgaste mínimo y larga duración. Broca de alto rendimiento para taladrado a percusión en hormigón, piedra natural y mampostería.



Oberfläche: kugelgestrahlt  
Surface: GM-finish  
Superficie: GM-finish



SB-Aufhänger  
Plastic tag  
Gancho para autoservicio

d1 mm	l1 mm	l2 mm	d2	Code 580 Art.-Nr.	Inh. Cont.	
6,00	220	100	SDS-plus	0058000600100	1	1
8,00	270	150	SDS-plus	0058000800100	1	1
10,00	270	150	SDS-plus	0058001000100	1	1
12,00	320	200	SDS-plus	0058001200100	1	1
14,00	370	250	SDS-plus	0058001400100	1	1
16,00	370	250	SDS-plus	0058001600100	1	1

Gesteinsbohrer, SDS-Bohrer und Meißel  
Concrete and Masonry drill bits, SDS hammer drill bits and chisels  
Broca para piedra, broca de percusión SDS y cincelos

### ① Hammerfeste SDS-plus Bohrkronen

**Einsatzbereich:**

Hammerfeste Schlagbohrkronen mit hochfestem Kronengrundkörper und Hartmetallschneidern in Hammerbohrerqualität. Für Beton und Mauerwerk.



Hart  
Hard  
Dura



Leistungsstark  
Efficient  
Alto rendimiento



Oberfläche: kugelgestrahlt  
Surface: GM-finish  
Superficie: GM-finish

### ② Hammer-active SDS-plus core bit

**Range of application:**

Hammer-active core bit with high strength base body and carbide tips in SDS hammer drilling quality, for concrete and masonry.

### ③ Corona de perforar resistente a la percusión SDS-plus

**Ámbito de aplicación:**

Corona de perforar a percusión resistente al martillo con cuerpo base de la corona de alta resistencia y filos de metal duro con la calidad de una broca de percusión. Para hormigón y mampostería.



Drehpack mit Aufhänger  
Twistpack with tag  
Paquete giratorio con gancho para autoservicio

Länge / Length / Longitud: 85/65 mm

d1 mm	l1 mm	l2 mm	d2	Code 897 Art.-Nr.	Inh. Cont.
25,00	85	65	SDS-plus	0089702500100	1
30,00	85	65	SDS-plus	0089703000100	1
35,00	85	65	SDS-plus	0089703500100	1
40,00	85	65	SDS-plus	0089704000100	1
50,00	85	65	SDS-plus	0089705000100	1
66,00	85	65	SDS-plus	0089706600100	1
68,00	85	65	SDS-plus	0089706800100	1
80,00	85	65	SDS-plus	0089708000100	1

Aufnahmeschaft einzeln  
Single arbor / Espiga de soporte individual (1 unid.)

l1 mm	d2 mm	Code 898 Art.-Nr.	Inh. Cont.
95	1/4"	0089800095100	1
110	SDS-plus	0089800110100	1
220	SDS-plus	0089800200100	1

Zentrierbohrer einzeln  
Single pilot drill / Broca de centrar individual (1 unid.)

d1 mm	l1 mm	l2 mm	Code 899 Art.-Nr.	Inh. Cont.
8,00	120	70	0089900800100	1



**D** SDS-plus Meißel  
"DEMOLISHER Plus"

**Einsatzbereich:**

Spezialhärtung mit extrem harter Spitze, dadurch extrem leistungsfähig. Maximale Stabilität und verschleißfestes Einsteckende.



Leistungsstark  
Efficient  
Alto rendimiento



Stabil  
Stable  
Estable

**E** SDS-plus chisels  
"DEMOLISHER Plus"

**Range of application:**

Special hardening with extremely hard tip, therefore extremely efficient. Maximum stability and wear-resistant insertion end.

**ES** Cincel SDS-plus  
"DEMOLISHER Plus"

**Ámbito de aplicación:**

Endurecimiento especial con punta extremadamente dura para un rendimiento excelente. Estabilidad máxima y encastre resistente al desgaste.

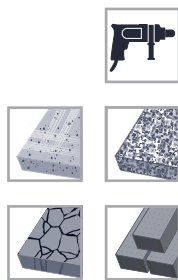

Oberfläche: kugelgestrahlt  
Surface: GM-finish  
Superficie: GM-finish

SB-Aufhänger  
Plastic tag  
Gancho para autoservicio



	l1 mm	b mm	d2	Code 987 Art.-Nr.	Inh. Cont.	
Spitz / point / punta	250		SDS-plus	0098700251100	1	1
Flach / flat / plana	250	20-25	SDS-plus	0098700252100	1	1
Breit / wide / ancha	250	40-50	SDS-plus	0098700253100	1	1

Gesteinsbohrer, SDS-Bohrer und Meißel  
Concrete and Masonry drill bits, SDS hammer drill bits and chisels  
Broca para piedra, broca de percusión SDS y cincelos

**① SDS-plus Meißel**  
Länge 250 mm

**② SDS-plus chisels**  
length 250 mm

**③ Cíncel SDS-plus**  
Longitud 250 mm

**Einsatzbereich:**

Für allgemeine Meißel- und Abbrucharbeiten von Mauerwerk, Beton und Gestein. Für alle Bohrhämmer mit SDS-plus Aufnahme.

**Range of application:**

For general chiselling and demolition work in masonry, concrete and stone. For all hammer drills with SDS-plus adapters.

**Ámbito de aplicación:**

Para trabajos generales con cíncelos y de demolición de mampostería, hormigón y piedra. Para todos los martillos perforadores con toma SDS-plus.



Leistungsstark  
Efficient  
Alto rendimiento



Hart  
Hard  
Dura

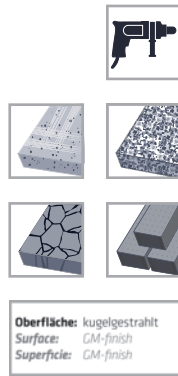

Oberfläche: kugelgestrahlt  
Surface: GM-finish  
Superficie: GM-finish

SB-Aufhänger  
Plastic tag  
Gancho para autoservicio



	l1 mm	b mm	d2	Code Art.-Nr.	Inh. Cont.	
	250		SDS-plus	0098000250100	1	1
<b>Spitz / point / punta</b>	250		SDS-plus	0098001250100	1	10*
	250	20	SDS-plus	0098100250100	1	1
<b>Flach / flat / plana</b>	250	20	SDS-plus	0098101250100	1	10*
	250	40	SDS-plus	0098200425100	1	1
<b>Breit / wide / ancha</b>	250	40	SDS-plus	0098201425100	1	10*
	250	22	SDS-plus	0098300225100	1	1
<b>Hohl / gouge / hueco</b>	250	50	SDS-plus	0098300505100	1	1
<b>Breit gekröpft / wide cranked / acodada ancha</b>	165	75	SDS-plus	0098500165100	1	1
<b>Extra breit / extra wide / ancha especial</b>	250	22	SDS-plus	0098400225100	1	1
<b>Flügel / winged gouge / ala</b>						

\*) Ohne SB-Aufhänger  
without plastic tag  
sin gancho para autoservicio

**D** Kassetten, Sets

**E** Cassettes, sets

**ES** Cajas, juegos

SDS-plus Meißel-Set BOX 3			SDS-plus F4 Forte Mix BOX 8			SDS-plus F4 Forte KIT SET 16		
  <p>3-tlg. / 3-pcs. / 3-unid. Kunststoffbox / Plastic box / Caja de plástico Art.-Nr. 0098000003100</p>			  <p>8-tlg. / 8-pcs. / 8-unid. Kunststoffbox / Plastic box / Caja de plástico Art.-Nr. 0000500008100</p>			  <p>16-tlg. / 16-pcs. / 16-unid. Set Art.-Nr. 0000500016100</p>		
Inhalt	l1	Stk. <sup>(1)</sup>	Inhalt	l1	Stk. <sup>(1)</sup>	Inhalt	l1	Stk. <sup>(1)</sup>
Contents / Contenido	mm	pc. <sup>(1)</sup>	Contents / Contenido	mm	pc. <sup>(1)</sup>	Contents / Contenido	mm	pc. <sup>(1)</sup>
Meißel / Chisel / Cincel:			Bohrer / Drill bits / Broca:			Bohrer / Drill bits / Broca:		
Spitz / point / punta	250	1	Ø 6,00 / 8,00 / 10,00 / 12,00	160	1	Ø 5,00 / 6,00	110	1
Flach / flat / plana	250	1	Ø 8,00 / 10,00	210	1	Ø 6,00 / 8,00 / 10,00 / 12,00	160	1
Breit / wide / ancha	250	1	Meißel / Chisel / Cincel:			Ø 6,00 / 8,00 / 10,00	210	1
			Spitz / point / punta		1	Ø 8,00 / 10,00 / 12,00 / 14,00	260	1
			Flach / flat / plana		1	Meißel / Chisel / Cincel:		
						Spitz / point / punta		1
						Flach / flat / plana		1
						Breit / wide / ancha		1
SDS-plus FORCE X KIT SET 16			SDS-plus Mix Set F4 Forte KM 6			SDS-plus Kurzmeißel-Set		
  <p>16-tlg. / 16-pcs. / 16-unid. Set Art.-Nr. 0000500216100</p>			  <p>6-tlg. / 6-pcs. / 6-unid. Metallkassette / Metal cassette / Caja de metal Art.-Nr. 0081700006100</p>			  <p>3-tlg. / 3-pcs. / 3-unid. Röhrchen / Tube / Tubo Art.-Nr. 0098000013100</p>		
Inhalt	l1	Stk. <sup>(1)</sup>	Ø	l1	Stk. <sup>(1)</sup>	Inhalt	l1	Stk. <sup>(1)</sup>
Contents / Contenido	mm	pc. <sup>(1)</sup>	mm	mm	pc. <sup>(1)</sup>	Contents / Contenido	mm	pc. <sup>(1)</sup>
Bohrer / Drill bits / Broca:			F4 Forte			Spitz / point / punta		
Ø 5,00 / 6,00	110	1	Ø 5,00 / 6,00 / 8,00 / 10,00	160	1	Flach / flat / plana	20 x 140	1
Ø 6,00 / 8,00 / 10,00 / 12,00	160	1	Meißel / Chisel / Cincel:			Breit / wide / ancha	30 x 140	1
Ø 6,00 / 8,00 / 10,00	210	1	Spitz / point / punta		1			
Ø 8,00 / 10,00 / 12,00 / 14,00	260	1	Flach / flat / plana		1			
Meißel / Chisel / Cincel:								
Spitz / point / punta		1						
Flach / flat / plana		1						
Breit / wide / ancha		1						



Gesteinsbohrer, SDS-Bohrer und Meißel  
Concrete and Masonry drill bits, SDS hammer drill bits and chisels  
Broca para piedra, broca de percusión SDS y cincelos

<sup>(1)</sup> Stück je Abmessung / Pieces each dimension / Piezas por diámetro

**① SDS-max Hammerbohrer**

**② SDS-max hammer drill bits**

**③ Broca de percusión SDS-max**

**Einsatzbereich:**

Für alle Bohrhämmer mit SDS-max Aufnahme. Zum Hammerbohren in Beton, Naturstein und Mauerwerk.

**Range of application:**

High efficiency drill bit for heavy-duty SDS-max hammer drilling of concrete, natural stone, masonry.

**Ámbito de aplicación:**

Para todos los martillos perforadores con toma SDS-max. Para el taladrado a percusión en hormigón, piedra natural y mampostería.



Leistungsstark  
Efficient  
Alto rendimiento



Hart  
Hard  
Dura



Präzise  
Precise  
Preciso

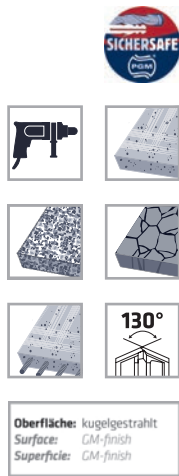
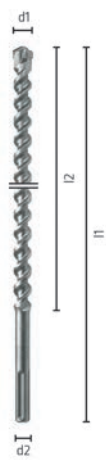

Oberfläche: kugelgestraht  
Surface: GM-finish  
Superficie: GM-finish



SB-Aufhänger  
Plastic tag  
Gancho para autoservicio

d1 mm	l1 mm	l2 mm	d2	Code 889 Art.-Nr.	Inh. Cont.	
12,00	340	200	SDS-max	0088901200100	1	1
13,00	340	200	SDS-max	0088901300100	1	1
14,00	340	200	SDS-max	0088901400100	1	1
15,00	340	200	SDS-max	0088901500100	1	1
16,00	340	200	SDS-max	0088901600100	1	1
18,00	340	200	SDS-max	0088901800100	1	1
20,00	320	200	SDS-max	0088902000100	1	1
22,00	320	200	SDS-max	0088902200100	1	1
24,00	320	200	SDS-max	0088902400100	1	1
25,00	320	200	SDS-max	0088902500100	1	1
26,00	320	200	SDS-max	0088902600100	1	1

Länge / Length / Longitud: 320/200 mm

d1 mm	l1 mm	l2 mm	d2	Code 890 Art.-Nr.	Inh. Cont.	
28,00	320	200	SDS-max	0089002800100	1	1
30,00	320	200	SDS-max	0089003000100	1	1
32,00	320	200	SDS-max	0089003200100	1	1
35,00	320	200	SDS-max	0089003500100	1	1
38,00	320	200	SDS-max	0089003800100	1	1
40,00	320	200	SDS-max	0089004000100	1	1

SB-Aufhänger  
 Plastic tag  
 Gancho para autoservicio

d1 mm	l1 mm	l2 mm	d2	Code 891 Art.-Nr.	Inh. Cont.	
12,00	540	400	SDS-max	0089101200100	1	1
13,00	540	400	SDS-max	0089101300100	1	1
14,00	540	400	SDS-max	0089101400100	1	1
15,00	540	400	SDS-max	0089101500100	1	1
16,00	540	400	SDS-max	0089101600100	1	1
18,00	540	400	SDS-max	0089101800100	1	1
19,00	520	400	SDS-max	0089101900100	1	1
20,00	520	400	SDS-max	0089102000100	1	1
22,00	520	400	SDS-max	0089102200100	1	1
24,00	520	400	SDS-max	0089102400100	1	1
25,00	520	400	SDS-max	0089102500100	1	1
26,00	520	400	SDS-max	0089102600100	1	1

Länge / Length / Longitud: 520/400 mm

d1 mm	l1 mm	l2 mm	d2	Code 892 Art.-Nr.	Inh. Cont.	
28,00	520	400	SDS-max	0089202800100	1	1
30,00	520	400	SDS-max	0089203000100	1	1
32,00	520	400	SDS-max	0089203200100	1	1
35,00	520	400	SDS-max	0089203500100	1	1
38,00	520	400	SDS-max	0089203800100	1	1
40,00	520	400	SDS-max	0089204000100	1	1
45,00	520	400	SDS-max	0089204500100	1	1
50,00	520	400	SDS-max	0089205000100	1	1

d1 mm	l1 mm	l2 mm	d2	Code 893 Art.-Nr.	Inh. Cont.	
12,00	740	600	SDS-max	0089301200100	1	1
28,00	720	600	SDS-max	0089302800100	1	1
35,00	720	600	SDS-max	0089303500100	1	1

d1 mm	l1 mm	l2 mm	d2	Code 894 Art.-Nr.	Inh. Cont.	
16,00	940	800	SDS-max	0089401600100	1	1
18,00	920	800	SDS-max	0089401800100	1	1
20,00	920	800	SDS-max	0089402000100	1	1
22,00	920	800	SDS-max	0089402200100	1	1
25,00	920	800	SDS-max	0089402500100	1	1
32,00	920	800	SDS-max	0089403200100	1	1
40,00	920	800	SDS-max	0089404000100	1	1

Länge / Length / Longitud: 1320/1200 mm

d1 mm	l1 mm	l2 mm	d2	Code 895 Art.-Nr.	Inh. Cont.	
22,00	1320	1200	SDS-max	0089502200100	1	1
25,00	1320	1200	SDS-max	0089502500100	1	1
32,00	1320	1200	SDS-max	0089503200100	1	1
40,00	1320	1200	SDS-max	0089504000100	1	1



Gesteinsbohrer, SDS-Bohrer und Meißel  
 Concrete and Masonry drill bits, SDS hammer drill bits and chisels  
 Broca para piedra, broca de percusión SDS y cincelos

① Set

Ⓔ Set

Ⓔ Juego

SDS-max Mix BOX 5



5-tlg. / 5-pcs. / 5-unid.

Kunststoffbox / Plastic box / Caja de plástico

Art.-Nr. 0089100005100

Inhalt <i>Contents / Contenido</i>	l1 <i>mm</i>	Stk. <sup>(1)</sup> <i>pc. <sup>(1)</sup></i>
<i>Meißel / Chisel / Cincel:</i>		
Spitz / point / punta		1
Flach / flat / plana		1
<i>Bohrer / Drill bits / Broca:</i>		
Ø 25,00	520	1
Ø 30,00 / 35,00	520	1

<sup>(1)</sup> Stück je Abmessung / Pieces each dimension / Piezas por diámetro

**D SDS-max Bohrkronen**

**E SDS-max core bit**

**ES Corona de perforar SDS-max**

**Einsatzbereich:**

Die Hartmetall-Zähne ermöglichen hohe Standzeiten. Durch die wechselnde Zahnfolge können Bohren und Meißeln in einem Arbeitsgang durchgeführt werden. Zum Bearbeiten von Beton, Naturstein, Mauerwerk, Marmor und Klinker.



Stabil  
Stable  
Estable



Hart  
Hard  
Dura

**Range of application:**

High durabilities are achieved due to the tungsten carbide teeth. Because of the changing tooth order, drilling and chiseling can be done in one operation. For heavy duty SDS-max hammer drilling of concrete, natural stone, masonry and marble.

**Ámbito de aplicación:**

Los dientes de metal duro hacen posible un largo tiempo de uso. Gracias a la secuencia de dientes cambiante se pueden realizar agujeros y cincelados en una misma operación. Para procesar hormigón, piedra natural, mampostería, mármol y ladrillos.



Gesteinsbohrer, SDS-Bohrer und Meißel  
Concrete and Masonry drill bits, SDS hammer drill bits and chisels  
Broca para piedra, broca de percusión SDS y cincelos

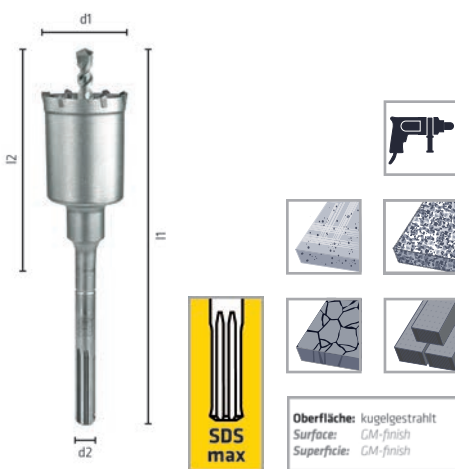

Oberfläche: kugelgestrahlt  
Surface: GM-finish  
Superficie: GM-finish



Drehpack  
Twistpack  
Paquete giratorio

**Länge / Length / Longitud: 290/170 mm**

d1 mm	l1 mm	l2 mm	d2	Code 871 Art.-Nr.	Inh. Cont.	
50,00	290	170	SDS-max	0087105000100	1	1
68,00	290	170	SDS-max	0087106800100	1	1
80,00	290	170	SDS-max	0087108000100	1	1

**Länge / Length / Longitud: 550/430 mm**

d1 mm	l1 mm	l2 mm	d2	Code 872 Art.-Nr.	Inh. Cont.	
50,00	550	430	SDS-max	0087205000100	1	1
68,00	550	430	SDS-max	0087206800100	1	1
80,00	550	430	SDS-max	0087208000100	1	1
100,00	550	430	SDS-max	0087209999100	1	1
125,00	550	430	SDS-max	0087212500100	1	1

Zentrierbohrer für Bohrkronen / Centre drill for drilling crown / Broca de centrar para corona de perforar

Plastiktasche  
Plastic wallet / Embalaje de plástico

d1 mm	l1 mm	Code 871 Art.-Nr.	Inh. Cont.	
12,00	128	0087101200100	1	1

**Die Bohrtiefe setzt sich aus mehreren Schritten zusammen: jeweils nach Erreichen der Nutzlänge Kern ausbrechen.**

The drilling depth is done in several steps: after reaching the working length break up the core.

La profundidad de perforación se compone de varios pasos: cada vez que se alcanza la longitud útil romper el núcleo.

**SDS-max Fräskrone**

**E SDS-max milling crown**

**ES Corona de fresar SDS-max**

**Einsatzbereich:**

Sicherer Ansatz auch in Ecken durch langen Zentrierbohrer. Exakte Bohrlochgeometrie auch bei tiefen Bohrlöchern. Durch asynchrone Bohrkopfstruktur schnelle Bohrmehlförderung. Zum Bearbeiten von Beton, Mauerwerk, Marmor und Klinker.

**Range of application:**

Safe fixing even in corners thanks to long centre drill. Precise geometry of the drilling hole even at deep holes. Due to the asynchronous structure of the drilling head the drilling dust will be moved faster. For heavy-duty cutting in concrete, masonry and marble.

**Ámbito de aplicación:**

Seguridad de uso incluso en las esquinas gracias a su larga broca de centrar. Geometría exacta de los agujeros incluso en agujeros de perforación profundos. Su estructura de cabezal asíncrono permite la rápida eliminación de los detritos. Para procesar hormigón, mampostería, mármol y ladrillos.



Präzise  
Precise  
Preciso



Schneller Bohrfortschritt  
Fast drilling progress  
Avance de perforación rápido

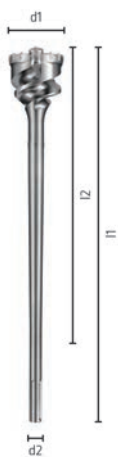

Oberfläche: kugelgestraht  
Surface: GM-finish  
Superficie: GM-finish

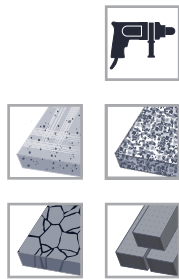

Einzelverpackung  
Single packing  
Embalaje individual

**Länge / Length / Longitud: 550/450 mm**

d1 mm	l1 mm	l2 mm	Code 885 Art.-Nr.	Inh. Cont.	
45,00	550	450	0088504500100	1	1
55,00	550	450	0088505500100	1	1
65,00	550	450	0088506500100	1	1
80,00	550	450	0088508000100	1	1

**Länge / Length / Longitud: 990/850 mm**

d1 mm	l1 mm	l2 mm	Code 886 Art.-Nr.	Inh. Cont.	
45,00	990	850	0088604500100	1	1
55,00	990	850	0088605500100	1	1
65,00	990	850	0088606500100	1	1
80,00	990	850	0088608000100	1	1

**Gewindefett / Thread grease / Grasa para roscas**

**Dose / Can / Caja**

Inhalt Contents / Contenido	Code 888 Art.-Nr.	Inh. Cont.	
200 g	0088800002100	1	1



**D** SDS-max Meißel  
„DEMOLISHER Max“

**Einsatzbereich:**

Spezialhärtung mit extrem harter Spitze, dadurch extrem leistungsfähig. Maximale Stabilität und verschleißfestes Einsteckende.



Leistungsstark  
Efficient  
Alto rendimiento



Stabil  
Stable  
Estable

**E** SDS-max chisels  
„DEMOLISHER Max“

**Range of application:**

Special hardening with extremely hard tip, therefore extremely efficient. Maximum stability and wear-resistant insertion end.

**ES** Cincel SDS-max  
„DEMOLISHER Max“

**Ámbito de aplicación:**

Endurecimiento especial con una punta extremadamente dura para un rendimiento excelente. Estabilidad máxima y encastre resistente al desgaste.

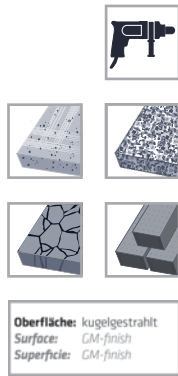

Oberfläche: kugelgestrahlt  
Surface: GM-finish  
Superficie: GM-finish

SB-Aufhänger  
Plastic tag  
Gancho para autoservicio

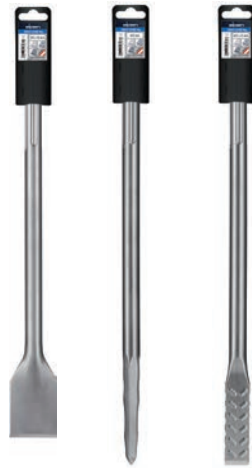

	l1 mm	b mm	d2	Code 973 Art.-Nr.	Inh. Cont.	
Breit / wide / ancha	380	50	SDS-max	0097300253100	1	1
Spitz / point / punta	400		SDS-max	0097300251100	1	1
Flach / flat / plana	400	25	SDS-max	0097300252100	1	1

Gesteinsbohrer, SDS-Bohrer und Meißel  
Concrete and Masonry drill bits, SDS hammer drill bits and chisels  
Broca para piedra, broca de percusión SDS y cincelos

**D** SDS-max Meißel

**E** SDS-max chisels

**ES** Cincel SDS-max

**Einsatzbereich:**

Für allgemeine Meißel- und Abbrucharbeiten von Mauerwerk, Beton und Gestein. Für alle Bohrhämmer mit SDS-max Aufnahme.

**Range of application:**

For general chiselling and demolition work in masonry, concrete and stone. For all hammer drills with SDS-max adapters.

**Ámbito de aplicación:**

Para trabajos generales con cinceles y de demolición de mampostería, hormigón y piedra. Para todos los martillos perforadores con toma SDS-max.



Leistungsstark  
Efficient  
Alto rendimiento



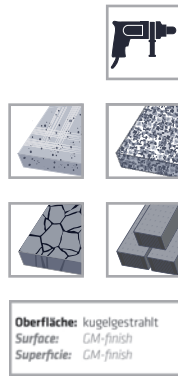
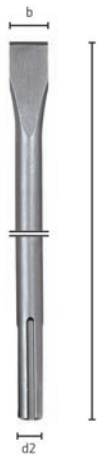

Hart  
Hard  
Dura



Oberfläche: kugelgestrahlt  
Surface: GM-finish  
Superficie: GM-finish

SB-Aufhänger  
Plastic tag  
Gancho para autoservicio







	l1 mm	b mm	d2	Code 970 Art.-Nr.	Inh. Cont.	
Spitz / point / punta	280		SDS-max	0097000280100	1	1
Spitz / point / punta	400		SDS-max	0097000400100	1	1
Spitz / point / punta	600		SDS-max	0097000600100	1	1
	l1 mm	b mm	d2	Code 971 Art.-Nr.	Inh. Cont.	
Flach / flat / plana	280	25	SDS-max	0097100280100	1	1
Flach / flat / plana	400	25	SDS-max	0097100400100	1	1
Flach / flat / plana	600	25	SDS-max	0097100600100	1	1
	l1 mm	b mm	d2	Code 978 Art.-Nr.	Inh. Cont.	
Breit / wide / ancha	300	75	SDS-max	0097800830100	1	1
Breit / wide / ancha	350	115	SDS-max	0097801135100	1	1
Breit / wide / ancha	400	50	SDS-max	0097800540100	1	1
	l1 mm	b mm	d2	Code 979 Art.-Nr.	Inh. Cont.	
Breit gekröpft / wide cranked / acodada ancha	300	80	SDS-max	0097900830100	1	1
Breit gekröpft / wide cranked / acodada ancha	400	50	SDS-max	0097900530100	1	1
	l1 mm	b mm	d2	Code 974 Art.-Nr.	Inh. Cont.	
<b>NEW</b> Stockermeißel / Bushing chisel / Cincel dentado	240	50	SDS-max	0097405024100	1	1
Hohl / gouge / hueco	300	26	SDS-max	0097402630100	1	1

**D** Kassetten, Sets

**E** Cassettes, sets

**ES** Cajas, juegos

SDS-max Meißel BOX 2			SDS-max Mix BOX 5		
 			 		
2-tlg. / 2-pcs. / 2-unid. Kunststoffbox / Plastic box / Caja de plástico Art.-Nr. 0097004002100			5-tlg. / 5-pcs. / 5-unid. Kunststoffbox / Plastic box / Caja de plástico Art.-Nr. 0089100005100		
Inhalt	l1	Stk. <sup>(1)</sup>	Inhalt	l1	Stk. <sup>(1)</sup>
<i>Contents / Contenido</i>	<i>mm</i>	<i>pc. <sup>(1)</sup></i>	<i>Contents / Contenido</i>	<i>mm</i>	<i>pc. <sup>(1)</sup></i>
Meißel / Chisel / Cincel:			Meißel / Chisel / Cincel:		
Spitz / point / punta	400	1	Spitz / point / punta		1
Flach / flat / plana	400	1	Flach / flat / plana		1
Bohrer / Drill bits / Broca:			Bohrer / Drill bits / Broca:		
			Ø 25,00	520	1
			Ø 30,00 / 35,00	520	1



Gesteinsbohrer, SDS-Bohrer und Meißel  
 Concrete and Masonry drill bits, SDS hammer drill bits and chisels  
 Broca para piedra, broca de percusión SDS y cincelos

<sup>(1)</sup> Stück je Abmessung / Pieces each dimension / Piezas por diámetro

➊ Aufnahmeadapter

Ⓔ Shank adaptor

Ⓔ Adaptador de tomas

**Einsatzbereich:**

SDS-plus Kupplung mit SDS-max Aufnahme.  
Für alle Bohrhämmer mit SDS-max Aufnahme.

**Range of application:**

Converts SDS-max to SDS-plus. For all hammer drills with SDS-max shank.

**Ámbito de aplicación:**

Acoplamiento SDS-plus con toma SDS-max.  
Para todos los martillos perforadores con toma SDS-max.

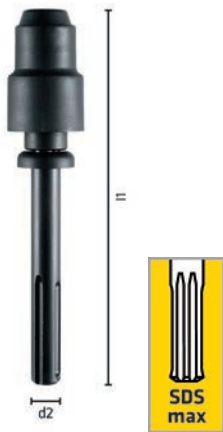

SB-Aufhänger  
Plastic tag  
Gancho para autoservicio

Länge / Length / Longitud: 223 mm

l1 mm	d2	Code 996 Art.-Nr.	Inh. Cont.
223	SDS-max	0099600021100	1

**D** Drehzahlen  
SDS-plus / SDS-max

Bitte beachten Sie die Drehzahl-empfehlungen des jeweiligen Bohrhammer-Maschinenherstellers.

**E** Spindle speeds  
SDS-plus / SDS-max

Please note the spindle speed of the respective hammer drilling machine recommended by the manufacturer.

**ES** Velocidades  
SDS-plus / SDS-max

Tenga en cuenta las recomendaciones de velocidad del fabricante respectivo de máquinas de martillos perforadores.

**D** Drehzahlen

Die angegebenen Schnittwertempfehlungen beziehen sich auf Standardanwendungen.

**E** Spindle speeds

The recommended cutting data refer to standard applications.

**ES** Velocidades

Las recomendaciones indicadas de los valores de corte se refieren a aplicaciones estándar.

**Profi Beton**

**Long Life**



**Code 188, 189, 727, 737**

Ø mm	U/min.   rpm   r.p.m.			
3	3000	3000	2100	1300
4	2400	3000	1600	1000
5	1900	2500	1300	800
5,5	1750	2300	1200	750
6	1600	2100	1100	700
6,5	1500	1950	1000	650
7	1400	1800	900	600
8	1200	1600	800	500
9	1100	1400	700	450
10	950	1300	650	400
12	800	1050	550	350
14	700	900	450	300
16	600	800	400	250
18	550	700	350	200
20	500	650	300	200

**Code 117, 118, 327, 367, 517, 617, 718**

Ø mm	U/min.   rpm   r.p.m.			
3	3000	3000	2600	1300
4	3000	2400	2000	1000
5	2500	1900	1600	800
5,5	2300	1750	1450	750
6	2100	1600	1300	700
6,5	1950	1500	1200	650
7	1800	1400	1100	600
8	1600	1200	1000	500
9	1400	1100	900	450
10	1250	950	800	400
11	1150	850	700	350
12	1050	800	650	350
13	950	750	600	300
14	900	700	600	300
15	850	650	550	250
16	800	600	500	250
18	700	550	450	200
20	650	500	400	200
22	600	450	350	150
24	550	400	350	150
25	500	400	300	150



Gesteinsbohrer, SDS-Bohrer und Meißel  
Concrete and Masonry drill bits, SDS hammer drill bits and chisels  
Broca para piedra, broca de percusión SDS y cincelos



# METALL- UND EDELSTAHLBOHRER



Ⓔ METAL DRILLS AND  
STAINLESS STEEL DRILLS

Ⓔ BROCA PARA METAL Y BROCA  
DE ACERO INOXIDABLE

Übersicht

Overview

Resumen

						
<b>Norm / Estándar</b>	DIN 1897		DIN 1897	WN	WN	WN
<b>Name / Nombre</b>	HSS PZ-Cobalt	HSS PZ-Cobalt	HSS PZ-COBALT GRIP	HSS Super	HSS Super	HSS Super
<b>Typ / Type / Tipo</b>	PZ	PZ	PZ			
<b>Bohrtiefe / Depth of drilling / Profundidad de perforación</b>	3xD	3xD	3xD	3xD	3xD	3xD
<b>Schneidstoff / Cutting material / Material de corte</b>	HSS-Co5	HSS-Co5	HSS-Co5	HSS	HSS	HSS
<b>Beschichtung / Coating / Recubrimiento</b>		<b>TiN</b>				
<b>Spitzenwinkel / Lip angle / Ángulo de la punta</b>	130°	130°	130°	118°	118°	118°
<b>Sonderanschliff / Special point shape / Punta afilada especial</b>	C (≥ Ø 2,0 mm)	C (≥ Ø 2,0 mm)	C (≥ Ø 2,0 mm)		C	C
<b>Schaft / Shank / Eje</b>						
<b>Ø mm</b>	1,00 - 13,00	1,00 - 13,00	1,00 - 20,00	3,10 - 5,20	3,10 - 6,10	3,00 - 5,30
<b>Code / Código</b>	901, 921	907	904, 906	321	331, 371	311
<b>Seite / Page / Página</b>	114	114	119	122	123	124
<b>Geeignet für / Suitable for / Adecuada para</b>						
 <b>Allgemeine Baustähle</b> Structural steels Aceros de construcción generales						
 <b>Automatenstähle</b> Free cutting steels Aceros de corte fácil						
 <b>Unlegierte Vergütungsstähle</b> Unalloyed heat treatable steels Aceros para bonifi car no aleados						
 <b>Legierte Vergütungsstähle</b> Alloyed heat treatable steels Aceros para bonifi car aleados						
 <b>Rostfreie Stähle</b> Stainless steels Aceros inoxidable						
 <b>Grauguss, Temperguss</b> Grey cast iron, malleable cast iron Hierro fundido gris, fundición maleable						
 <b>Titan- und Titanlegierungen</b> Titanium and titanium alloys Titanio y aleaciones de titanio						
 <b>Kupfer, Messing</b> Copper, brass Cobre, latón						
 <b>Aluminium</b> Aluminio Aluminio						
 <b>Kunststoffe</b> Plastics Plásticos						



Übersicht

Overview

Resumen

							
WN	WN	DIN 338	DIN 338	DIN 338		DIN 338	WN
HSS Super	HSS Sprint	HSS Co5	HSS Forte Cobalt	HSS Cobalt	HSS Cobalt	HSS COBALT GRIP	HSS COBALT STABLE
	RN	R-AS	FORTE	RN	RN	RN	H
3xD	3xD	5xD	5xD	5xD	5xD	5xD	3xD
HSS	HSS	HSS-Co5	HSS-Co5	HSS-Co5	HSS-Co5	HSS-Co5	HSS-Co5
				TiN			
118°	118°	130°	130°	130°	130°	130°	135°
		C	AC (≥ Ø 2,0 mm)	C (≥ Ø 2,0 mm)	C (≥ Ø 2,0 mm)	C (≥ Ø 2,0 mm)	C
							
2,50 - 6,35	14,28 - 25,40	2,00 - 13,00	1,00 - 13,00	1,00 - 16,00	1,00 - 16,00	1,00 - 20,00	2,00 - 13,00
301	734	663	183, 611	613, 623	607	655-656	638
125	126	127	131	135	135	140	143
							
							
							
							
							
							
							
							
							



Metal- und Edelstahlbohrer  
Metal drills and stainless steel drills  
broca para metal y broca de acero inoxidable

Übersicht

Overview

Resumen

						
Norm / Estándar	DIN 338	DIN 338	DIN 338	DIN 338	DIN 338	DIN 338
Name / Nombre	HSS DIN 338	PRO	PRO	HSS Super	Sprint Master	Sprint Master
Typ / Type / Tipo	RN	RN	RN	RN	RN	RN
Bohrtiefe / Depth of drilling / Profundidad de perforación	5xD	5xD	5xD	5xD	5xD	5xD
Schneidstoff / Cutting material / Material de corte	HSS	HSS	HSS	HSS	HSS	HSS
Beschichtung / Coating / Recubrimiento						
Spitzenwinkel / Lip angle / Ángulo de la punta	118°	135°	135°	118°	118°	118°
Sonderanschliff / Special point shape / Punta afilada especial	AC (≥ Ø 4,0 mm)	C (≥ Ø 3,0 mm)	C (≥ Ø 3,0 mm)			
Schaft / Shank / Eje						
Ø mm	0,20 - 20,00	1,00 - 13,00	2,00 - 8,00	1,00 - 13,00	0,40 - 20,00	10,50 - 20,00
Code / Código	601	184, 954	952	181, 951	618, 626, 631	640, 642, 648, 654
Seite / Page / Página	145	152	155	157	162	166
Geeignet für / Suitable for / Adecuada para						
 <b>Allgemeine Baustähle</b> Structural steels Aceros de construcción generales						
 <b>Automatenstähle</b> Free cutting steels Aceros de corte fácil						
 <b>Unlegierte Vergütungsstähle</b> Unalloyed heat treatable steels Aceros para bonifi car no aleados						
 <b>Legierte Vergütungsstähle</b> Alloyed heat treatable steels Aceros para bonifi car aleados						
 <b>Rostfreie Stähle</b> Stainless steels Aceros inoxidable						
 <b>Grauguss, Temporguss</b> Grey cast iron, malleable cast iron Hierro fundido gris, fundición maleable						
 <b>Titan- und Titanlegierungen</b> Titanium and titanium alloys Titanio y aleaciones de titanio						
 <b>Kupfer, Messing</b> Copper, brass Cobre, latón						
 <b>Aluminium</b> Aluminio Aluminio						
 <b>Kunststoffe</b> Plastics Plásticos						

Übersicht

Overview

Resumen

DIN 340	DIN 340	DIN 1869-1	DIN 1869-2	DIN 1869-3	WN	WN	WN	DIN 345
HSS DIN 340 RN	HSS Super	HSS DIN 1869 R1	HSS DIN 1869 R2	HSS DIN 1869 R3	HSS Super Fassadenbohrer	HSS Cobalt Schweisspunktbohrer	HSS Cobalt Schweisspunktbohrer	HSS DIN 345 RN
RN	RN	RN	RN	RN	RN			RN
10xD	10xD	>10xD	>10xD	>10xD				5xD
HSS	HSS	HSS	HSS	HSS	HSS	HSS-ECo	HSS-ECo	HSS
							<b>TiN</b>	
118°	118°	118°	118°	118°	120°	180°	180°	118°
AC (≥ Ø 4,0 mm)		AC	AC	AC	AC	E	E	A / AC
0,50 - 16,00	1,00 - 10,00	2,00 - 13,00	3,00 - 13,00	2,50 - 13,00	4,00 - 7,40	6,00 - 8,00	6,00 - 8,00	5,00 - 70,00
501	528, 551	100-101	111	121	123-127	130, 330	336	202
170	173	174	176	177	178	180	180	181



Metal- und Edelstahlbohrer  
Metal drills and stainless steel drills  
broca para metal y broca de acero inoxidable

**① HSS Cobalt Spiralbohrer, extra kurz, DIN 1897 PZ**

**Einsatzbereich:**

5% kobaltlegierter Spiralbohrer mit verstärktem Kerndurchmesser. Besonders geeignet für zähe und harte Werkstoffe wie rost- und säurebeständige Chrom-Nickelstähle. Durch die kurze Bauweise sehr gut für Handbohrmaschinen geeignet.



Bruchsicher, kurze stabile Ausführung  
Break-resistant, short stable design  
A prueba de roturas, modelo corto y estable



Punktgenaues Anbohren  
Highly accurate centering  
Perforación de gran precisión



Industriequalität  
Industrial quality  
Calidad industrial

**② HSS Cobalt stub drills, extra short, DIN 1897 PZ**

**Range of application:**

5% cobalt-alloyed high-efficiency drills with re-inforced web. Specially suitable for drilling stainless steel, acid-resisting steel, spring steel. Best for hand held operations.

**③ Broca espiral HSS Cobalt, extra corta, DIN 1897 PZ**

**Ámbito de aplicación:**

Broca espiral con 5 % de aleación de cobalto y diámetro central reforzado. Especialmente adecuadas para materiales tenaces y duros, como aceros al cromo-níquel que resisten los ácidos y la corrosión. Muy adecuadas para taladradoras manuales gracias al diseño corto.

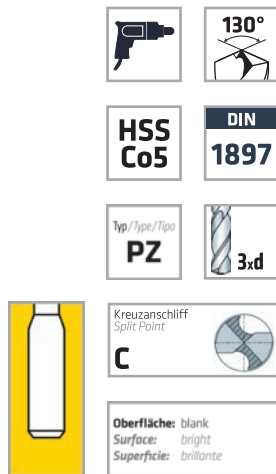
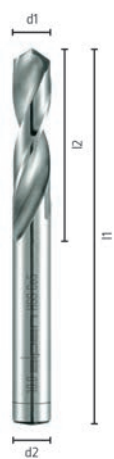

Einzelverpackung  
Single pack  
Embalaje individual



Gewerbepack  
Industrial packing  
Paquete industrial



**TiN**  
Hohe Performance, lange Standzeit  
High performance, long durability  
Rendimiento elevado, duración prolongada

Einzelverpackung  
Single packing  
Embalaje individual

d1 mm	l1 mm	l2 mm	blank / bright / brillante			blank / bright / brillante			TiN	
			Code 921 Art.-Nr.	Inh. Cont.		Code 901 Art.-Nr.	Inh. Cont.	Code 907 Art.-Nr.	Inh. Cont.	
1,00	26	6				0090100100100	10		0090700100100	1
1,10	28	7				0090100110100	10		0090700110100	1
1,20	30	8				0090100120100	10		0090700120100	1
1,30	30	8				0090100130100	10		0090700130100	1
1,40	32	9				0090100140100	10		0090700140100	1
1,50	32	9				0090100150100	10		0090700150100	1
1,60	34	10				0090100160100	10		0090700160100	1
1,70	34	10				0090100170100	10		0090700170100	1
1,80	36	11				0090100180100	10		0090700180100	1
1,90	36	11				0090100190100	10		0090700190100	1
2,00	38	12	0092100200100	1	10	0090100200100	10		0090700200100	1
2,10	38	12				0090100210100	10		0090700210100	1
2,20	40	13				0090100220100	10		0090700220100	1
2,30	40	13				0090100230100	10		0090700230100	1
2,40	43	14				0090100240100	10		0090700240100	1
2,50	43	14	0092100250100	1	10	0090100250100	10		0090700250100	1
2,60	43	14				0090100260100	10		0090700260100	1
2,70	46	16				0090100270100	10		0090700270100	1
2,80	46	16				0090100280100	10		0090700280100	1
2,90	46	16				0090100290100	10		0090700290100	1
3,00	46	16	0092100300100	1	10	0090100300100	10		0090700300100	1
3,10	49	18				0090100310100	10		0090700310100	1



			Einzelverpackung <i>Single pack</i> <i>Embalaje individual</i>			Gewerbepack <i>Industrial packing</i> <i>Paquete industrial</i>			Einzelverpackung <i>Single packing</i> <i>Embalaje individual</i>		
			blank / bright / brillante			blank / bright / brillante			TIN		
d1 mm	l1 mm	l2 mm	Code 921 Art.-Nr.	Inh. Cont.		Code 901 Art.-Nr.	Inh. Cont.		Code 907 Art.-Nr.	Inh. Cont.	
8,80	84	40				0090100880100	10		0090700880100	1	
8,90	84	40				0090100890100	10		0090700890100	1	
9,00	84	40	0092100900100	1	10	0090100900100	10		0090700900100	1	
9,10	84	40				0090100910100	10		0090700910100	1	
9,20	84	40				0090100920100	10		0090700920100	1	
9,30	84	40				0090100930100	10		0090700930100	1	
9,40	84	40				0090100940100	10		0090700940100	1	
9,50	84	40	0092100950100	1	10	0090100950100	10		0090700950100	1	
9,60	89	43				0090100960100	10		0090700960100	1	
9,70	89	43				0090100970100	10		0090700970100	1	
9,80	89	43				0090100980100	10		0090700980100	1	
9,90	89	43				0090100990100	10		0090700990100	1	
10,00	89	43	0092101000100	1	10	0090101000100	10		0090701000100	1	
10,20	89	43	0092101020100	1	10	0090101020100	1		0090701020100	1	
10,50	89	43				0090101050100	1		0090701050100	1	
11,00	95	47				0090101100100	1		0090701100100	1	
11,50	95	47				0090101150100	1		0090701150100	1	
12,00	102	51				0090101200100	1		0090701200100	1	
12,50	102	51				0090101250100	1		0090701250100	1	
13,00	102	51				0090101300100	1		0090701300100	1	

Kreuzanschliff  $\geq \varnothing 2,0$  mm / Split Point  $\geq \varnothing 2,0$  mm / Punta afilada en cruz  $\geq \varnothing 2,0$  mm

**D** Kassetten, Sets

**E** Cassettes, sets

**ES** Cajas, juegos

HSS PZ-Cobalt TM 6		HSS PZ-Cobalt KM 10	
			
6-tlg. / 6-pcs. / 6-unid. Kunststoffkassette / Plastic cassette / Caja de plástico Art.-Nr. 0000100906100		10-tlg. / 10-pcs. / 10-unid. Metallkassette / Metal cassette / Caja de metal Art.-Nr. 0000100910100	
Ø	Stk. <sup>(1)</sup>	Ø	Stk. <sup>(1)</sup>
mm	pc. <sup>(1)</sup>	mm	pc. <sup>(1)</sup>
HSS PZ-Cobalt		HSS PZ-Cobalt	
Ø 2,00 / 3,00 / 4,00 / 5,00 / 6,00 / 8,00	1	Ø 3,00 / 3,20 / 3,50 / 4,00 / 4,20 / 4,50 / 5,00 / 6,00 / 8,00 / 10,00	1



Metal- und Edelstahlbohrer  
 Metal drills and stainless steel drills  
 broca para metal y broca de acero inoxidable

<sup>(1)</sup> Stück je Abmessung / Pieces each dimension / Piezas por diámetro



## HSS PZ-COBALT GRIP



### **Stabiles, bruchsaicheres Bohren**

Die bruch sichere, kurze Bauweise kombiniert mit einem verstärkten Kerndurchmesser garantieren größte Stabilität

### **Stable, shatter-proof drilling**

The shatter-proof, short design combined with a reinforced web guarantee maximum stability

### **Perforación estable resistente a las roturas**

La combinación del diseño corto resistente a las roturas y del diámetro central reforzado garantiza gran estabilidad

### **Exakte Ergebnisse**

Dank eines selbstzentrierten Spezialanschliffs

### **Precise results**

Thanks to a self-centering special point shape

### **Resultados exactos**

Gracias a su punta afilada especial autocentrado

### **Für harte Materialien**

Bohrt selbst die zähesten und härtesten Werkstoffe

### **For hard materials**

Drills even the toughest and hardest materials

### **Para materiales duros**

Perfora incluso los materiales más duros y resistentes

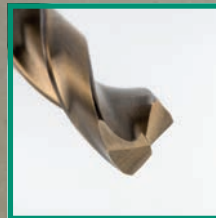



**D HSS Cobalt Spiralbohrer, 3-Flächenschaft, extra kurz, DIN 1897 PZ**

**Einsatzbereich:**

5% kobaltlegierter Spiralbohrer mit verstärktem Kerndurchmesser. Besonders geeignet für zähe und harte Werkstoffe wie rost- und säurebeständige Chrom-Nickelstähle. Durch die kurze Bauweise sehr gut für Handbohrmaschinen geeignet. Der 3-Flächenschaft verhindert das Durchdrehen im Bohrfutter und sorgt für eine optimale Drehmomentübertragung.



Bruchsicher, kurze stabile Ausführung  
Break-resistant, short stable design  
A prueba de roturas, modelo corto y estable



Punktgenaues Anbohren  
Highly accurate centering  
Perforación de gran precisión



3-Flächenschaft  
3-surface shank  
3 caras

**E HSS Cobalt stub drills, 3-surface shank, DIN 1897 PZ**

**Range of application:**

5% cobalt-alloyed high-efficiency drills with re-inforced web. Specially suitable for drilling stainless steel, acid-resisting steel, spring-steel. Best for hand held operations. The 3-surface shank prevents slipping in the chuck and ensures optimum torque transmission.

**ES Broca espiral HSS Cobalt, eje de 3 cantos, extra corta, DIN 1897 PZ**

**Ámbito de aplicación:**

Broca espiral con 5% de aleación de cobalto y diámetro central reforzado. Especialmente adecuada para materiales tenaces y duros, como aceros al cromo-níquel que resisten los ácidos y la corrosión. Muy adecuada para taladradoras manuales gracias al diseño corto. El nuevo vástago antideslizante evita la rotación en el portabrocas y asegura una transmisión de torsión óptima.

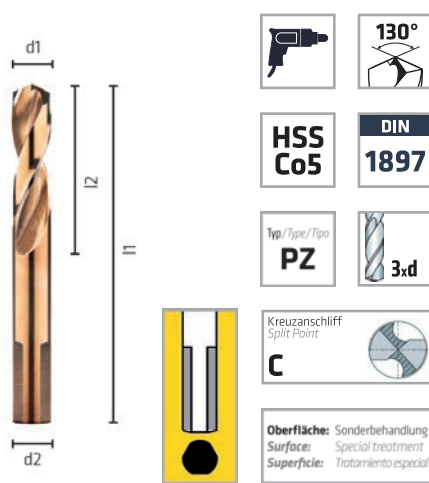

Einzelverpackung  
Single pack  
Embalaje individual



Gewerbepack  
Industrial packing  
Paquete industrial

d1 mm	l1 mm	l2 mm	d2 mm	Code 904 Art.-Nr.	Inh. Cont.		Code 906 Art.-Nr.	Inh. Cont.
1,00	26	6		0090400100100	1	10	0090600100100	10
1,50	32	9		0090400150100	1	10	0090600150100	10
1,60	34	10					0090600160100	10
2,00	38	12		0090400200100	1	10	0090600200100	10
2,50	43	14		0090400250100	1	10	0090600250100	10
3,00	46	16		0090400300100	1	10	0090600300100	10
3,20	49	18		0090400320100	1	10	0090600320100	10
3,30	49	18		0090400330100	1	10	0090600330100	10
3,50	52	20		0090400350100	1	10	0090600350100	10
4,00	55	22		0090400400100	1	10	0090600400100	10
4,10	55	22					0090600410100	10
4,20	55	22		0090400420100	1	10	0090600420100	10
4,50	58	24		0090400450100	1	10	0090600450100	10
5,00	62	26		0090400500100	1	10	0090600500100	10
5,10	62	26					0090600510100	10
5,20	62	26					0090600520100	10
5,50	66	28		0090400550100	1	10	0090600550100	10
6,00	66	28		0090400600100	1	10	0090600600100	10
6,50	70	31		0090400650100	1	10	0090600650100	10
6,80	74	34		0090400680100	1	10	0090600680100	10
7,00	74	34		0090400700100	1	10	0090600700100	10
7,50	74	34		0090400750100	1	10	0090600750100	10



Metall- und Edelstahlbohrer  
Metal drills and stainless steel drills  
broca para metal y broca de acero inoxidable



				Einzelverpackung <i>Single pack</i> <i>Embalaje individual</i>			Gewerbepack <i>Industrial packing</i> <i>Paquete industrial</i>	
d1 mm	l1 mm	l2 mm	d2 mm	Code 904 Art.-Nr.	Inh. Cont.		Code 906 Art.-Nr.	Inh. Cont.
8,00	79	37		0090400800100	1	10	0090600800100	10
8,50	79	37		0090400850100	1	10	0090600850100	10
9,00	84	40		0090400900100	1	10	0090600900100	10
9,50	84	40		0090400950100	1	10	0090600950100	10
10,00	89	43		0090401000100	1	10	0090601000100	10
10,20	89	43		0090401020100	1	10	0090601020100	1
10,50	89	43					0090601050100	1
11,00	95	47					0090601100100	1
11,50	95	47					0090601150100	1
12,00	102	51					0090601200100	1
12,50	102	51					0090601250100	1
13,00	102	51					0090601300100	1
13,50	107	54	9,50				0090601350100	1
14,00	107	54	9,50				0090601400100	1
14,50	111	56	9,50				0090601450100	1
15,00	111	56	9,50				0090601500100	1
15,50	115	58	9,50				0090601550100	1
16,00	115	58	9,50				0090601600100	1
17,00	119	60	12,50				0090601700100	1
18,00	123	62	12,50				0090601800100	1
19,00	127	64	12,50				0090601900100	1
20,00	131	66	12,50				0090602000100	1

Kreuzanschliff  $\geq \varnothing 2,0$  mm / Split Point  $\geq \varnothing 2,0$  mm / Punta afilada en cruz  $\geq \varnothing 2,0$  mm  
 Zylindrischer Schaft  $\leq \varnothing 3,5$  mm / Cylindrical shank  $\leq \varnothing 3,5$  mm / Eje cilíndrico  $\leq \varnothing 3,5$  mm

**D** Kassetten, Sets

**E** Cassettes, sets

**ES** Cajas, juegos

HSS PZ-COBALT GRIP TM 6		HSS PZ-COBALT GRIP KM 10		HSS PZ-COBALT GRIP KP 24	
					
6-tlg. / 6-pcs. / 6-unid. Kunststoffkassette / Plastic cassette / Caja de plástico Art.-Nr. 0090600006100		10-tlg. / 10-pcs. / 10-unid. Metallkassette / Metal cassette / Caja de metal Art.-Nr. 0090600010100		24-tlg. / 24-pcs. / 24-unid. Kunststoffkassette / Plastic cassette / Caja de plástico Art.-Nr. 0090600024100	
Ø mm	Stk. <sup>(1)</sup> pc. <sup>(1)</sup>	Ø mm	Stk. <sup>(1)</sup> pc. <sup>(1)</sup>	Ø mm	Stk. <sup>(1)</sup> pc. <sup>(1)</sup>
HSS PZ-COBALT GRIP		HSS PZ-COBALT GRIP		HSS PZ-COBALT GRIP	
Ø 2,00 / 3,00 / 4,00 / 5,00 / 6,00 / 8,00	1	Ø 3,00 / 3,20 / 3,50 / 4,00 / 4,20 / 4,50 / 5,00 / 6,00 / 8,00 / 10,00	1	Ø 1,00 / 1,50 / 2,00 / 2,50 / 3,00 / 3,30 / 3,50 / 4,00 / 4,20 / 4,50 / 5,00 / 5,50 / 6,00 / 6,50 / 6,80 / 7,00 / 7,50 / 8,00 / 8,50 / 9,00 / 9,50 / 10,00 / 10,20 / 10,50	1



Metal- und Edelstahlbohrer  
Metal drills and stainless steel drills  
broca para metal y broca de acero inoxidable

<sup>(1)</sup> Stück je Abmessung / Pieces each dimension / Piezas por diámetro

**① HSS Blindnietbohrer, doppelseitig**

**Einsatzbereich:**

Spiralbohrer zum Bohren von dünnen Materialien, z. B. Spenglereien, Karosseriewerkstätten usw., für Handbohrmaschinen. Nicht für normale Bohrtiefen einsetzen.

**② HSS stub drills for rivets, double-ended**

**Range of application:**

Drill with extremely sturdy construction, particularly suitable for drilling thin materials. Used in portable-handtools, mainly in body panel shops, car repair shops etc.

**③ Broca de remache ciego HSS de dos caras**

**Ámbito de aplicación:**

Broca espiral para perforar materiales finos, p. ej., hojalaterías, talleres de carrocería, etc., para taladradoras manuales. No debe utilizarse para profundidades de perforación convencionales.



Präzise  
Precise  
Preciso



Scharfe Schneiden  
Sharp cutting edges  
Filos bien afilados



Bruchstabil  
Break-resistant  
Resistente a la rotura



Oberfläche: dampfangelassen  
Surface: steam tempered  
Superficie: templado al vapor



Gewerbepack  
Industrial packing  
Paquete industrial

d1 mm	l1 mm	l2 mm	Code 321 Art.-Nr.	Inh. Cont.
3,10	49	14	0032100310100	10
3,20	49	14	0032100320100	10
3,25	49	14	0032100325100	10
3,30	49	14	0032100330100	10
3,50	52	17	0032100350100	10
4,00	55	17	0032100400100	10
4,10	55	17	0032100410100	10
4,20	55	17	0032100420100	10
4,90	62	20	0032100490100	10
5,10	62	20	0032100510100	10
5,20	62	20	0032100520100	10

**D** HSS Blindnietbohrer,  
doppelseitig

**Einsatzbereich:**

Spiralbohrer zum Bohren von dünnen Materialien, z. B. Spenglereien, Karosseriewerkstätten usw., für Handbohrmaschinen. Nicht für normale Bohrtiefen einsetzen.

**E** HSS stub drills for rivets,  
double-ended

**Range of application:**

Drill with extremely sturdy construction, particularly suitable for drilling thin materials. Used in portable-handtools, mainly in body panel shops, car repair shops etc.

**ES** Broca de remache ciego HSS  
de dos caras

**Ámbito de aplicación:**

Broca espiral para perforar materiales finos, p. ej., hojalaterías, talleres de carrocería, etc., para taladradoras manuales. No debe utilizarse para profundidades de perforación convencionales.



Präzise  
Precise  
Preciso



Scharfe Schneiden  
Sharp cutting edges  
Filos bien afilados



Bruchstabil  
Break-resistant  
Resistente a la rotura



**118°**

**HSS**

Cu  
Ms  
Ni  
Zn

Alu

Kreuzanschliff  
Split Point

**C**

Oberfläche: blank  
Surface: bright  
Superficie: brillante



Einzelverpackung  
Single pack  
Embalaje individual



Gewerbepack  
Industrial packing  
Paquete industrial

d1 mm	l1 mm	l2 mm	Code 371 Art.-Nr.	Inh. Cont.		Code 331 Art.-Nr.	Inh. Cont.
3,10	49	14	0037100310100	2	10	0033100310100	10
3,20	49	14	0037100320100	2	10	0033100320100	10
3,25	49	14	0037100325100	2	10	0033100325100	10
3,30	49	14	0037100330100	2	10	0033100330100	10
4,10	55	17	0037100410100	2	10	0033100410100	10
4,20	55	17	0037100420100	2	10	0033100420100	10
4,90	62	20	0037100490100	2	10	0033100490100	10
5,10	62	20	0037100510100	2	10	0033100510100	10
<b>6,10</b>	70	23	<b>0037100610100</b>	2	10		

NEW



Metall- und Edelstahlbohrer  
Metal drills and stainless steel drills  
broca para metal y broca de acero inoxidable

**① HSS Blindnietbohrer mit Kreuzanschliff**

**Einsatzbereich:**

Spiralbohrer zum Bohren von dünnen Materialien, z. B. Spenglereien, Karosseriewerkstätten usw., für Handbohrmaschinen. Nicht für normale Bohrtiefen einsetzen.

**② HSS stub drills for rivets with split point**

**Range of application:**

Drill with extremely sturdy construction, particularly suitable for drilling thin materials. Used in portable-handtools, mainly in body panel shops, car repair shops etc.

**③ Broca de remache ciego HSS con punta afilada en cruz**

**Ámbito de aplicación:**

Broca espiral para perforar materiales finos, p. ej., hojalaterías, talleres de carrocería, etc., para taladradoras manuales. No debe utilizarse para profundidades de perforación convencionales.



Punktgenaues Anbohren  
Highly accurate centering  
Perforación de gran precisión



Präzise  
Precise  
Preciso



Bruchstabil  
Break-resistant  
Resistente a la rotura



	<b>118°</b>	<b>HSS</b>
	<b>Alu</b>	
	<b>Cu Ms Ni Zn</b>	
	<b>Kreuzanschliff Split Point</b>	
	<b>C</b>	
<b>Oberfläche: blank</b> <b>Surface: bright</b> <b>Superficie: brillante</b>		

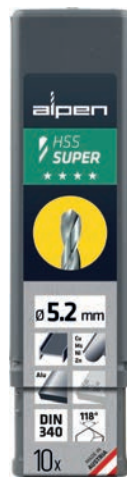

Gewerbepack  
Industrial packing  
Paquete industrial

d1 mm	l1 mm	l2 mm	Code 311 Art.-Nr.	Inh. Cont.
3,00	46	14	0031100300100	10
3,10	49	14	0031100310100	10
3,20	49	14	0031100320100	10
3,25	49	14	0031100325100	10
3,30	49	14	0031100330100	10
3,50	52	17	0031100350100	10
4,00	55	17	0031100400100	10
4,10	55	17	0031100410100	10
4,20	55	17	0031100420100	10
4,90	62	20	0031100490100	10
5,10	62	20	0031100510100	10
5,20	62	20	0031100520100	10
5,30	62	20	0031100530100	10

**D HSS Blindnietbohrer**

**E HSS stub drills for rivets**

**ES Broca de remache ciego HSS**

**Einsatzbereich:**

Spiralbohrer zum Bohren von dünnen Materialien, z. B. Spenglereien, Karosseriewerkstätten usw., für Handbohrmaschinen. Nicht für normale Bohrtiefen einsetzen.

**Range of application:**

Drill with extremely sturdy construction, particularly suitable for drilling thin materials. Used in portable-handtools, mainly in body panel shops, car repair shops etc.

**Ámbito de aplicación:**

Broca espiral para perforar materiales finos, p.ej., hojalaterías, talleres de carrocería, etc., para taladradoras manuales. No debe utilizarse para profundidades de perforación convencionales.



Präzise  
Precise  
Preciso



Scharfe Schneiden  
Sharp cutting edges  
Filos bien afilados



Bruchstabil  
Break-resistant  
Resistente a la rotura



118°  
HSS  
Alu  
Cu  
Ms  
Ni  
Zn  
Oberfläche: dampfangelassen  
Surface: steam tempered  
Superficie: templada al vapor



Gewerbepack  
Industrial packing  
Paquete industrial

d1 mm	d1 inch	l1 mm	l2 mm	Code 301 Art.-Nr.	Inh. Cont.
2,50		43	95	0030100250100	10
3,10		49	14	0030100310100	10
3,18	1/8	49	14	0030100318100	10
3,20		49	14	0030100320100	10
3,25		49	14	0030100325100	10
3,30		49	14	0030100330100	10
3,57	9/64	52	17	0030100357100	10
3,97	5/32	55	17	0030100397100	10
4,10		55	17	0030100410100	10
4,20		55	17	0030100420100	10
4,37	11/64	58	20	0030100437100	10
4,76	3/16	62	20	0030100476100	10
4,90		62	20	0030100490100	10
5,00		62	20	0030100500100	10
5,10		62	20	0030100510100	10
5,16	13/64	62	20	0030100516100	10
5,20		62	20	0030100520100	10
5,56	7/32	66	23	0030100556100	10
6,35	1/4	70	23	0030100635100	10



Metal- und Edelstahlbohrer  
Metal drills and stainless steel drills  
broca para metal y broca de acero inoxidable

<sup>(1)</sup> Stück je Abmessung / Pieces each dimension / Piezas por diámetro

**① HSS Spiralbohrer, extra kurz,  
mit reduziertem Schaft  
Ø 12,7 mm (1/2")**

**Einsatzbereich:**

Universeller Spiralbohrer, hohe Elastizität. Sehr gut geeignet für den Einsatz in Handbohrmaschinen, zum Bearbeiten von legiertem und unlegiertem Stahl.

**② HSS twist drill, extra short,  
with reduced shank  
Ø 12,7 mm (1/2")**

**Range of application:**

HSS twist drill: toughness and precision combined with excellent cutting efficiency for drilling alloyed carbon and plain steel. Ideal for hand held operations.

**③ Broca espiral HSS, extra corta,  
con eje reducido  
Ø 12,7 mm (1/2")**

**Ámbito de aplicación:**

Broca espiral universal, alta elasticidad. Muy adecuada para su uso en taladradoras manuales. Para el procesamiento de acero aleado y no aleado.



Schneller Bohrfortschritt  
Fast drilling progress  
Avance de perforación rápida



Elastisch  
Resilient  
Elástica



Bruchstabil  
Break-resistant  
Resistente a la rotura



Gewerbepack  
Industrial packing  
Paquete industrial

d1 mm	d1 inch	l1 mm	l2 mm	d2 mm	Code 734 Art.-Nr.	Inh. Cont.
14,28	9/16	157	84	12,70	0073401428100	1
15,87	5/8	157	84	12,70	0073401587100	1
17,46	11/16	158	85	12,70	0073401746100	1
19,05	3/4	158	85	12,70	0073401905100	1
20,64	13/16	159	86	12,70	0073402064100	1
21,00		159	86	12,70	0073402100100	1
22,00		159	86	12,70	0073402200100	1
22,22	7/8	159	86	12,70	0073402222100	1
23,00		159	86	12,70	0073402300100	1
23,81	15/16	160	87	12,70	0073402381100	1
24,00		160	87	12,70	0073402400100	1
25,00		160	87	12,70	0073402500100	1
25,40	1	160	87	12,70	0073402540100	1



**D HSS Cobalt Spiralbohrer, kurz, DIN 338 R-AS**

**Einsatzbereich:**

5% kobaltlegierter Spezialbohrer in sehr stabiler Bauweise für sehr schwer zerspanbare Werkstoffe wie rost- und säurebeständige austenitische Stähle sowie hitzebeständige Stähle.

**E HSS Cobalt jobber drills, DIN 338 R-AS**

**Range of application:**

5% cobalt-alloyed drills in a solid sturdy construction, specially suitable for stainless austenitic steels as well as heat resistant steels.

**ES Broca espiral HSS Cobalt, corta, DIN 338 R-AS**

**Ámbito de aplicación:**

Broca especial con 5% de aleación de cobalto, especialmente estable, materiales muy difícilmente mecanizables con virutaje, aceros austeníticos resistentes a los ácidos y la corrosión, así como aceros resistentes al calor.



Rostfreie Stähle  
Stainless steels  
Aceros inoxidables



Bruchstabil  
Break-resistant  
Resistente a la rotura



Industriequalität  
Industrial quality  
Calidad industrial

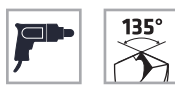

Gewerbepack  
Industrial packing  
Paquete industrial

d1 mm	l1 mm	l2 mm	Code 663 Art.-Nr.	Inh. Cont.
2,00	49	24	0066300200100	10
2,10	49	24	0066300210100	10
2,20	53	27	0066300220100	10
2,30	53	27	0066300230100	10
2,40	57	30	0066300240100	10
2,50	57	30	0066300250100	10
2,60	57	30	0066300260100	10
2,70	61	33	0066300270100	10
2,80	61	33	0066300280100	10
2,90	61	33	0066300290100	10
3,00	61	33	0066300300100	10
3,10	65	36	0066300310100	10
3,20	65	36	0066300320100	10
3,30	65	36	0066300330100	10
3,40	70	39	0066300340100	10
3,50	70	39	0066300350100	10
3,60	70	39	0066300360100	10
3,70	70	39	0066300370100	10
3,80	75	43	0066300380100	10
3,90	75	43	0066300390100	10
4,00	75	43	0066300400100	10
4,10	75	43	0066300410100	10



Metal- und Edelstahlbohrer  
Metal drills and stainless steel drills  
broca para metal y broca de acero inoxidable

Gewerbepack  
*Industrial packing*  
*Paquete industrial*

d1 mm	l1 mm	l2 mm	Code 663 Art.-Nr.	Inh. Cont.
4,20	75	43	0066300420100	10
4,30	80	47	0066300430100	10
4,40	80	47	0066300440100	10
4,50	80	47	0066300450100	10
4,60	80	47	0066300460100	10
4,70	80	47	0066300470100	10
4,80	86	52	0066300480100	10
4,90	86	52	0066300490100	10
5,00	86	52	0066300500100	10
5,10	86	52	0066300510100	10
5,20	86	52	0066300520100	10
5,30	86	52	0066300530100	10
5,40	93	57	0066300540100	10
5,50	93	57	0066300550100	10
5,60	93	57	0066300560100	10
5,70	93	57	0066300570100	10
5,80	93	57	0066300580100	10
5,90	93	57	0066300590100	10
6,00	93	57	0066300600100	10
6,10	101	63	0066300610100	10
6,20	101	63	0066300620100	10
6,30	101	63	0066300630100	10
6,40	101	63	0066300640100	10
6,50	101	63	0066300650100	10
6,60	101	63	0066300660100	10
6,70	101	63	0066300670100	10
6,80	109	69	0066300680100	10
6,90	109	69	0066300690100	10
7,00	109	69	0066300700100	10
7,10	109	69	0066300710100	10
7,20	109	69	0066300720100	10
7,30	109	69	0066300730100	10
7,40	109	69	0066300740100	10
7,50	109	69	0066300750100	10
7,60	117	75	0066300760100	10
7,70	117	75	0066300770100	10
7,80	117	75	0066300780100	10
7,90	117	75	0066300790100	10
8,00	117	75	0066300800100	10
8,10	117	75	0066300810100	10
8,20	117	75	0066300820100	10
8,30	117	75	0066300830100	10
8,40	117	75	0066300840100	10
8,50	117	75	0066300850100	10
8,60	125	81	0066300860100	10
8,70	125	81	0066300870100	10
8,80	125	81	0066300880100	10
8,90	125	81	0066300890100	10
9,00	125	81	0066300900100	10
9,10	125	81	0066300910100	10
9,20	125	81	0066300920100	10
9,30	125	81	0066300930100	10
9,40	125	81	0066300940100	10
9,50	125	81	0066300950100	10
9,60	133	87	0066300960100	10
9,70	133	87	0066300970100	10

Gewerbepack  
*Industrial packing*  
*Paquete industrial*

d1 mm	l1 mm	l2 mm	Code 663 Art.-Nr.	Inh. Cont.
9,80	133	87	0066300980100	10
9,90	133	87	0066300990100	10
10,00	133	87	0066301000100	10
10,20	133	87	0066301020100	5
10,50	133	87	0066301050100	5
11,00	142	94	0066301100100	5
11,50	142	94	0066301150100	5
12,00	151	101	0066301200100	5
12,50	151	101	0066301250100	5
13,00	151	101	0066301300100	5



Metall- und Edelstahlbohrer  
*Metal drills and stainless steel drills*  
*broca para metal y broca de acero inoxidable*



## HSS FORTE COBALT



### **Noch härter**

Hohe Belastbarkeit durch Nitro-oxidierete Fase

### **Even harder**

High resilience due to nitro-oxidized chamfer

### **Todavía más resistente**

Alta resistencia gracias a la etapa nitro-oxidada

### **Exakte Ergebnisse**

Dank eines selbstzentrierten Spezialanschliffs

### **Precise results**

Thanks to a self-centering special point shape

### **Resultados exactos**

Gracias a su punta afilada especial autocentrado

### **Exakte, tiefe Löcher**

Die großen Spanräume garantieren präzise, tiefe Löcher bei hartem Stahl

### **Precise, deep holes**

The large chip spaces guarantee precise, deep holes in hard steel

### **Agujeros precisos y profundos**

El espacio ancho para virutas garantiza orificios precisos y profundos incluso en acero duro

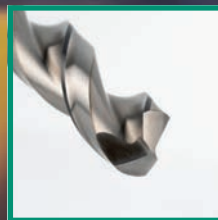

**D** HSS Cobalt Spiralbohrer, kurz, DIN 338 Forte

**E** HSS Cobalt jobber drills, DIN 338 Forte

**ES** Broca espiral HSS Cobalt, corta, DIN 338 Forte

**Einsatzbereich:**

5% kobaltlegierter Spiralbohrer mit sehr hoher thermischer Belastbarkeit. Durch spezielle Nutausbildung bei schlechter Spanabfuhr bzw. für größere Bohrtiefen geeignet. Für Werkstoffe mit einer Festigkeit bis 1.300 N/mm<sup>2</sup>.

**Range of application:**

5% cobalt-alloyed jobber drills with an extremely sturdy construction (re-reinforced web) for drilling under difficult conditions e. g. poor chipremoval and deep holes, for use in steel and cast-iron with tensile strength up to 1.300 N/mm<sup>2</sup>.

**Ámbito de aplicación:**

Broca espiral HSS con 5% de aleación de cobalto y muy alta clasificación térmica. Adecuada para una separación de virutas deficiente o para grandes profundidades de perforación gracias a la conformación especial de la ranura. Para materiales con una resistencia de hasta 1300 N/mm<sup>2</sup>.



Tieflochbohrer für hochfeste Stähle  
Deep hole twist drills for high tensile steels  
Broca de perforación profunda para aceros de alta resistencia



Schneller Bohrfortschritt  
Fast drilling progress  
Avance de perforación rápido



Punktgenaues Anbohren  
Highly accurate centering  
Perforación de gran precisión



Einzelverpackung  
Single pack  
Embalaje individual



Gewerbepack  
Industrial packing  
Paquete industrial

d1 mm	l1 mm	l2 mm	Code 183 Art.-Nr.	Inh. Cont.		Code 611 Art.-Nr.	Inh. Cont.
1,00	34	12	0018300100100	1	10	0061100100100	10
1,10	36	14				0061100110100	10
1,20	38	16				0061100120100	10
1,30	38	16				0061100130100	10
1,40	40	18				0061100140100	10
1,50	40	18	0018300150100	1	10	0061100150100	10
1,60	43	20				0061100160100	10
1,70	43	20				0061100170100	10
1,80	46	22				0061100180100	10
1,90	49	24				0061100190100	10
2,00	49	24	0018300200100	1	10	0061100200100	10
2,10	49	24				0061100210100	10
2,20	53	27				0061100220100	10
2,30	53	27				0061100230100	10
2,40	57	30				0061100240100	10
2,50	57	30	0018300250100	1	10	0061100250100	10
2,60	57	30				0061100260100	10
2,70	61	33				0061100270100	10
2,80	61	33				0061100280100	10
2,90	61	33				0061100290100	10
3,00	61	33	0018300300100	1	10	0061100300100	10
3,10	65	36				0061100310100	10



Metall- und Edelstahlbohrer  
Metal drills and stainless steel drills  
broca para metal y broca de acero inoxidable

			Einzelverpackung <i>Single pack</i> <i>Embalaje individual</i>			Gewerbepack <i>Industrial packing</i> <i>Paquete industrial</i>	
d1 mm	l1 mm	l2 mm	Code 183 Art.-Nr.	Inh. Cont.		Code 611 Art.-Nr.	Inh. Cont.
3,20	65	36	0018300320100	1	10	0061100320100	10
3,30	65	36	0018300330100	1	10	0061100330100	10
3,40	70	39				0061100340100	10
3,50	70	39	0018300350100	1	10	0061100350100	10
3,60	70	39				0061100360100	10
3,70	70	39				0061100370100	10
3,80	75	43				0061100380100	10
3,90	75	43				0061100390100	10
4,00	75	43	0018300400100	1	10	0061100400100	10
4,10	75	43				0061100410100	10
4,20	75	43	0018300420100	1	10	0061100420100	10
4,30	80	47				0061100430100	10
4,40	80	47				0061100440100	10
4,50	80	47	0018300450100	1	10	0061100450100	10
4,60	80	47				0061100460100	10
4,70	80	47				0061100470100	10
4,80	86	52				0061100480100	10
4,90	86	52				0061100490100	10
5,00	86	52	0018300500100	1	10	0061100500100	10
5,10	86	52				0061100510100	10
5,20	86	52				0061100520100	10
5,30	86	52				0061100530100	10
5,40	93	57				0061100540100	10
5,50	93	57	0018300550100	1	10	0061100550100	10
5,60	93	57				0061100560100	10
5,70	93	57				0061100570100	10
5,80	93	57				0061100580100	10
5,90	93	57				0061100590100	10
6,00	93	57	0018300600100	1	10	0061100600100	10
6,10	101	63				0061100610100	10
6,20	101	63				0061100620100	10
6,30	101	63				0061100630100	10
6,40	101	63				0061100640100	10
6,50	101	63	0018300650100	1	10	0061100650100	10
6,60	101	63				0061100660100	10
6,70	101	63				0061100670100	10
6,80	109	69	0018300680100	1	10	0061100680100	10
6,90	109	69				0061100690100	10
7,00	109	69	0018300700100	1	10	0061100700100	10
7,10	109	69				0061100710100	10
7,20	109	69				0061100720100	10
7,30	109	69				0061100730100	10
7,40	109	69				0061100740100	10
7,50	109	69	0018300750100	1	10	0061100750100	10
7,60	117	75				0061100760100	10
7,70	117	75				0061100770100	10
7,80	117	75				0061100780100	10
7,90	117	75				0061100790100	10
8,00	117	75	0018300800100	1	10	0061100800100	10
8,10	117	75				0061100810100	10
8,20	117	75				0061100820100	10
8,30	117	75				0061100830100	10
8,40	117	75				0061100840100	10
8,50	117	75				0061100850100	10
8,60	125	81				0061100860100	10
8,70	125	81				0061100870100	10

			Einzelverpackung <i>Single pack</i> <i>Embalaje individual</i>			Gewerbepack <i>Industrial packing</i> <i>Paquete industrial</i>	
d1 mm	l1 mm	l2 mm	Code 183 Art.-Nr.	Inh. Cont.		Code 611 Art.-Nr.	Inh. Cont.
8,80	125	81				0061100880100	10
8,90	125	81				0061100890100	10
9,00	125	81	0018300900100	1	10	0061100900100	10
9,10	125	81				0061100910100	10
9,20	126	81				0061100920100	10
9,30	125	81				0061100930100	10
9,40	125	81				0061100940100	10
9,50	125	81				0061100950100	10
9,60	133	87				0061100960100	10
9,70	133	87				0061100970100	10
9,80	133	87				0061100980100	10
9,90	133	87				0061100990100	10
10,00	133	87	0018301000100	1	10	0061101000100	10
10,20	133	87				0061101020100	5
10,50	133	87				0061101050100	5
11,00	142	94	0018301100100	1	10	0061101100100	5
11,50	142	94				0061101150100	5
12,00	151	101	0018301200100	1	10	0061101200100	5
12,50	151	101				0061101250100	5
13,00	151	101	0018301300100	1	10	0061101300100	5











**Metall- und Edelstahlbohrer**  
Metal drills and stainless steel drills  
broca para metal y broca de acero inoxidable

Kreuzanschliff  $\geq \varnothing 2,0$  mm / Split Point  $\geq \varnothing 2,0$  mm / Punta afilada en cruz  $\geq \varnothing 2,0$  mm  
Oberfläche: fasennitriert  $\geq \varnothing 3,0$  mm / Surface: nitrided lands  $\geq \varnothing 3,0$  mm / Superficie: etapa nitro-oxidada  $\geq \varnothing 3,0$  mm

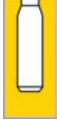
① Kassetten, Sets

Ⓔ Cassettes, sets

Ⓔ Cajas, juegos

HSS Forte Cobalt TM 6		HSS Forte Cobalt KM 19		HSS Forte Cobalt KM 25	
					
6-tlg. / 6-pcs. / 6-unid. Kunststoffkassette / Plastic cassette / Caja de plástico Art.-Nr. 0000100616100		19-tlg. / 19-pcs. / 19-unid. Metallkassette / Metal cassette / Caja de metal Art.-Nr. 0000100619100		25-tlg. / 25-pcs. / 25-unid. Metallkassette / Metal cassette / Caja de metal Art.-Nr. 0000100625100	
Ø mm	Stk. <sup>(1)</sup> pc. <sup>(1)</sup>	Ø mm	 Stk. <sup>(1)</sup> pc. <sup>(1)</sup>	Ø mm	 Stk. <sup>(1)</sup> pc. <sup>(1)</sup>
HSS Forte Cobalt		HSS Forte Cobalt		HSS Forte Cobalt	
Ø 2,00 / 3,00 / 4,00 / 5,00 / 6,00 / 8,00	1	Ø 1,00-10,00	0,5	Ø 1,00-13,00	0,5

<sup>(1)</sup> Stück je Abmessung / Pieces each dimension / Piezas por diámetro



**D** HSS Cobalt Spiralbohrer, kurz,  
DIN 338 RN

**Einsatzbereich:**

5% kobaltlegierter Spiralbohrer mit sehr hoher thermischer Belastbarkeit zum Bohren von Werkstoffen mit höherem Legierungsgelalt und Festigkeit über 800 N/mm<sup>2</sup>.

**E** HSS Cobalt jobber drills,  
DIN 338 RN

**Range of application:**

5% cobalt-alloyed jobber drills with high heat-resistance for drilling steels with tensile strength over 800 N/mm<sup>2</sup>, specially suitable for high alloyed steels, bearing-steels, hot/cold-rolled steel. Ideal for stainless steel.

**ES** Broca espiral HSS Cobalt, corta,  
DIN 338 RN

**Ámbito de aplicación:**

Broca espiral HSS con 5% de aleación de cobalto y muy alta clasificación térmica. Especialmente adecuadas para aceros un porcentaje elevado de aleación con R > 800 N/mm<sup>2</sup>.



Punktgenaues Anbohren  
Highly accurate centering  
Perforación de gran precisión



Bruchstabil  
Break-resistant  
Resistente a la rotura



Industriequalität  
Industrial quality  
Calidad industrial

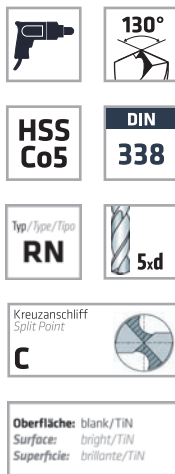
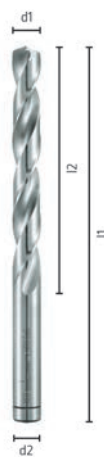

Einzelverpackung  
Single pack  
Embalaje individual



Gewerbepack  
Industrial packing  
Paquete industrial



**TiN**  
Hohe Performance,  
lange Standzeit  
High performance,  
long durability  
Rendimiento elevado,  
duración prolongada



Metall- und Edelstahlbohrer  
Metal drills and stainless steel drills  
broca para metal y broca de acero inoxidable

				blank / bright / brillante			blank / bright / brillante			TiN	
d1 mm	d1 inch	l1 mm	l2 mm	Code 623 Art.-Nr.	Inh. Cont.		Code 613 Art.-Nr.	Inh. Cont.	Code 607 Art.-Nr.	Inh. Cont.	
1,00		34	12	0062300100100	1	10	0061300100100	10	0060700100100	1	
1,10		36	14				0061300110100	10	0060700110100	1	
1,19	3/64	38	16				0061300119100	10	0060700119100	1	
1,20		38	16				0061300120100	10	0060700120100	1	
1,30		38	16				0061300130100	10	0060700130100	1	
1,40		40	18				0061300140100	10	0060700140100	1	
1,50		40	18	0062300150100	1	10	0061300150100	10	0060700150100	1	
1,59	1/16	43	20				0061300159100	10	0060700159100	1	
1,60		43	20				0061300160100	10	0060700160100	1	
1,70		43	20				0061300170100	10	0060700170100	1	
1,80		46	22				0061300180100	10	0060700180100	1	
1,90		46	22				0061300190100	10	0060700190100	1	
1,98	5/64	49	24				0061300198100	10	0060700198100	1	
2,00		49	24	0062300200100	1	10	0061300200100	10	0060700200100	1	
2,10		49	24				0061300210100	10	0060700210100	1	
2,20		53	27				0061300220100	10	0060700220100	1	
2,30		53	27				0061300230100	10	0060700230100	1	
2,38	3/32	57	30				0061300238100	10	0060700238100	1	
2,40		57	30				0061300240100	10	0060700240100	1	
2,50		57	30	0062300250100	1	10	0061300250100	10	0060700250100	1	
2,60		57	30				0061300260100	10	0060700260100	1	
2,70		61	33				0061300270100	10	0060700270100	1	





**D** Kassetten, Sets

**E** Cassettes, sets

**ES** Cajas, juegos

<p>HSS Cobalt TM 6</p> 			<p>HSS Cobalt KM 19</p> 			<p>HSS Cobalt KP 19</p> 		
<p>6-tlg. / 6-pcs. / 6-unid. Kunststoffkassette / Plastic cassette / Caja de plástico Art.-Nr. 0000100606100</p>			<p>19-tlg. / 19-pcs. / 19-unid. Metallkassette / Metal cassette / Caja de metal Art.-Nr. 0000100219100</p>			<p>19-tlg. / 19-pcs. / 19-unid. Kunststoffkassette / Plastic cassette / Caja de plástico Art.-Nr. 0000102219100</p>		
<b>Ø</b> mm		Stk. <sup>(1)</sup> pc. <sup>(1)</sup>	<b>Ø</b> mm		Stk. <sup>(1)</sup> pc. <sup>(1)</sup>	<b>Ø</b> mm		Stk. <sup>(1)</sup> pc. <sup>(1)</sup>
HSS Cobalt			HSS Cobalt			HSS Cobalt		
Ø 2,00 / 3,00 / 4,00 / 5,00 / 6,00 / 8,00		1	Ø 1,00-10,00	0,5	1	Ø 1,00-10,00	0,5	1
<p>HSS Cobalt KM 25</p> 			<p>HSS Cobalt KP 25</p> 			<p>HSS Cobalt KM 32</p> 		
<p>25-tlg. / 25-pcs. / 25-unid. Metallkassette / Metal cassette / Caja de metal Art.-Nr. 0000100225100</p>			<p>25-tlg. / 25-pcs. / 25-unid. Kunststoffkassette / Plastic cassette / Caja de plástico Art.-Nr. 0000102225100</p>			<p>32-tlg. / 32-pcs. / 32-unid. Metallkassette / Metal cassette / Caja de metal Art.-Nr. 0000101232100</p>		
<b>Ø</b> mm		Stk. <sup>(1)</sup> pc. <sup>(1)</sup>	<b>Ø</b> mm		Stk. <sup>(1)</sup> pc. <sup>(1)</sup>	<b>Ø</b> mm		Stk. <sup>(1)</sup> pc. <sup>(1)</sup>
HSS Cobalt			HSS Cobalt			HSS Cobalt		
Ø 1,00-13,00		0,5 1	Ø 1,00-13,00	0,5	1	Ø 1,00-10,50	0,5	1
						1,9/2,1/2,6/2,9/3,2/3,3/3,8/4,2/5,1/6,8/7,9/10,2		1
<p>HSS Cobalt KM 50</p> 			<p>HSS Cobalt KM 41</p> 			<p>HSS-E DIN Maschinengewindebohrersatz KM 14</p> 		
<p>50-tlg. / 50-pcs. / 50-unid. Metallkassette / Metal cassette / Caja de metal Art.-Nr. 0000101250100</p>			<p>41-tlg. / 41-pcs. / 41-unid. Metallkassette / Metal cassette / Caja de metal Art.-Nr. 0000101241100</p>			<p>14-tlg. / 14-pcs. / 14-unid. Metallkassette / Metal cassette / Caja de metal Art.-Nr. 0070800014100</p>		
<b>Ø</b> mm		Stk. <sup>(1)</sup> pc. <sup>(1)</sup>	<b>Ø</b> mm		Stk. <sup>(1)</sup> pc. <sup>(1)</sup>	<b>Ø</b> mm		Stk. <sup>(1)</sup> pc. <sup>(1)</sup>
HSS Cobalt			HSS Cobalt			HSS Cobalt		
Ø 1,00-5,90		0,1 1	Ø 6,00-10,00	0,1	1	Ø 2,50 / 3,30 / 4,20 / 5,00 / 6,80 / 8,50 / 10,20		1
						Ø M3 - M12		1

<sup>(1)</sup> Stück je Abmessung / Pieces each dimension / Piezas por diámetro



## HSS **COBALT GRIP**



**Selbstzentrierend**  
durch Spezialanschliff

**Self-centering**  
*thanks to special point shape*

**Autocentrado**  
*gracias a la punta especialmente afilada*

**Bis 600° C**  
Bohren auch bei höchsten  
Temperaturbelastungen

**Up to 600° C**  
*Drilling even with the highest thermal  
stress*

**Taladrado hasta 600° C**  
*Incluso bajo temperaturas extremas*

**Schnell**  
Durch speziellen Bohrerschiff schneller  
Bohrfortschritt und bis zu 50%  
weniger Vorschubdruck erforderlich

**Fast**  
*Due to special drill grinding fast drilling  
progress and up to 50% less feed  
pressure required*

**Rápida**  
*Gracias a la punta especialmente  
afilada avance rápido y presión de  
avance necesaria inferior al 50 %*

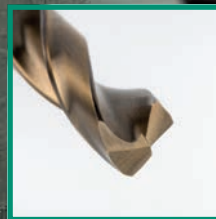

 **alpen** *drill better.*

① HSS Cobalt Spiralbohrer,  
3-Flächenschaft, kurz,  
DIN 338 RN

**Einsatzbereich:**

5% kobaltlegierter Spiralbohrer mit sehr hoher thermischer Belastbarkeit zum Bohren von Werkstoffen mit höherem Legierungsgehalt und Festigkeit über 800 N/mm<sup>2</sup>. Der 3-Flächenschaft verhindert das Durchdrehen im Bohrfutter und sorgt für eine optimale Drehmomentübertragung.



Industriequalität  
Industrial quality  
Calidad industrial



Bohren mit stark verminderten Anpressdruck  
Drilling with greatly reduced feed pressure  
Perforar con una presión de avance muy disminuida



3-Flächenschaft  
3-surface shank  
3 caras

② HSS Cobalt jobber drills,  
3-surface shank,  
DIN 338 RN

**Range of application:**

5% cobalt-alloyed jobber drills with high heat-resistance for drilling steels with tensile strength over 800 N/mm<sup>2</sup>, specially suitable for high alloyed steels, bearing-steels, hot/ cold-rolled steel. Ideal for stainless steel. The 3-surface shank prevents slipping in the chuck and ensures optimum torque transmission.

③ Broca espiral HSS Cobalt,  
eje de 3 cantos, corta,  
DIN 338 RN

**Ámbito de aplicación:**

Broca espiral HSS con 5% de aleación de cobalto y muy alta clasificación térmica. Especialmente adecuada para aceros con un porcentaje elevado de aleación de R > 800 N/mm<sup>2</sup>. El nuevo vástago antideslizante evita la rotación en el portabrocas y asegura una transmisión de torsión óptima.

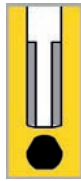

- 130°
- HSS Co5
- DIN 338
- Typ/Type/Tipo RN
- 5xd
- Kreuzanschliff Split Point C
- Oberfläche: Sonderbehandlung  
Surface: Special treatment  
Superficie: Tratamiento especial



Einzelverpackung  
Single pack  
Embalaje individual



Gewerbepack  
Industrial packing  
Paquete industrial

d1 mm	l1 mm	l2 mm	d2 mm	Code 655 Art.-Nr.	Inh. Cont.		Code 656 Art.-Nr.	Inh. Cont.
1,00	34	12		0065500100100	1	10	0065600100100	10
1,50	40	18		0065500150100	1	10	0065600150100	10
1,60	43	20					0065600160100	10
2,00	49	24		0065500200100	1	10	0065600200100	10
2,50	57	30		0065500250100	1	10	0065600250100	10
3,00	61	33		0065500300100	1	10	0065600300100	10
3,20	65	36		0065500320100	1	10	0065600320100	10
3,30	65	36		0065500330100	1	10	0065600330100	10
3,50	70	39		0065500350100	1	10	0065600350100	10
4,00	75	43		0065500400100	1	10	0065600400100	10
4,20	75	43		0065500420100	1	10	0065600420100	10
4,50	80	47		0065500450100	1	10	0065600450100	10
5,00	86	52		0065500500100	1	10	0065600500100	10
5,20	86	52					0065600520100	10
5,50	93	57		0065500550100	1	10	0065600550100	10
6,00	93	57		0065500600100	1	10	0065600600100	10
6,50	101	63		0065500650100	1	10	0065600650100	10
6,80	109	69		0065500680100	1	10	0065600680100	10
7,00	109	69		0065500700100	1	10	0065600700100	10
7,50	109	69		0065500750100	1	10	0065600750100	10
8,00	117	75		0065500800100	1	10	0065600800100	10
8,50	117	75		0065500850100	1	10	0065600850100	10

				Einzelverpackung <i>Single pack</i> <i>Embalaje individual</i>			Gewerbepack <i>Industrial packing</i> <i>Paquete industrial</i>	
d1 mm	l1 mm	l2 mm	d2 mm	Code 655 Art.-Nr.	Inh. Cont.		Code 656 Art.-Nr.	Inh. Cont.
9,00	125	81		0065500900100	1	10	0065600900100	10
9,50	125	81		0065500950100	1	10	0065600950100	10
10,00	133	87		0065501000100	1	10	0065601000100	10
10,20	133	87		0065501020100	1	10	0065601020100	5
10,50	133	87					0065601050100	5
11,00	142	94		0065501100100	1	10	0065601100100	5
11,50	142	94					0065601150100	5
12,00	151	101		0065501200100	1	10	0065601200100	5
12,50	151	101					0065601250100	5
13,00	151	101		0065501300100	1	10	0065601300100	5
13,50	160	108	9,50				0065601350100	1
14,00	160	108	9,50				0065601400100	1
14,50	169	114	9,50				0065601450100	1
15,00	169	114	9,50				0065601500100	1
15,50	178	120	9,50				0065601550100	1
16,00	178	120	9,50				0065601600100	1
17,00	184	125	12,50				0065601700100	1
18,00	191	130	12,50				0065601800100	1
19,00	198	135	12,50				0065601900100	1
20,00	205	140	12,50				0065602000100	1



**Metall- und Edelstahlbohrer**  
Metal drills and stainless steel drills  
broca para metal y broca de acero inoxidable

Kreuzanschliff  $\geq \varnothing 2,0$  mm / Split Point  $\geq \varnothing 2,0$  mm / Punta afilada en cruz  $\geq \varnothing 2,0$  mm  
Zylindrischer Schaft  $\leq \varnothing 3,5$  mm / Cylindrical shank  $\leq \varnothing 3,5$  mm / Eje cilíndrico  $\leq \varnothing 3,5$  mm

🇩🇪 Kassetten, Sets

🇪🇸 Cassettes, sets

🇪🇸 Cajas, juegos

<p>HSS COBALT GRIP TM 6</p>  			<p>HSS COBALT GRIP KM 19</p>  			<p>HSS COBALT GRIP KM 25</p>  		
<p>6-tlg. / 6-pcs. / 6-unid. Kunststoffkassette / Plastic cassette / Caja de plástico Art.-Nr. 0065600006100</p>			<p>19-tlg. / 19-pcs. / 19-unid. Metallkassette / Metal cassette / Caja de metal Art.-Nr. 0065600019100</p>			<p>25-tlg. / 25-pcs. / 25-unid. Metallkassette / Metal cassette / Caja de metal Art.-Nr. 0065600025100</p>		
Ø	Stk. <sup>(1)</sup>		Ø	Stk. <sup>(1)</sup>		Ø	Stk. <sup>(1)</sup>	
mm	pc. <sup>(1)</sup>		mm	pc. <sup>(1)</sup>		mm	pc. <sup>(1)</sup>	
HSS COBALT GRIP			HSS COBALT GRIP			HSS COBALT GRIP		
Ø 2,00 / 3,00 / 4,00 / 5,00 / 6,00 / 8,00	1		Ø 1,00-10,00	0,5	1	Ø 1,00-13,00	0,5	1
<p>HSS COBALT GRIP KP 19</p>  			<p>HSS COBALT GRIP KP 25</p>  					
<p>19-tlg. / 19-pcs. / 19-unid. Kunststoffkassette / Plastic cassette / Caja de plástico Art.-Nr. 0065600119100</p>			<p>25-tlg. / 25-pcs. / 25-unid. Kunststoffkassette / Plastic cassette / Caja de plástico Art.-Nr. 0065600125100</p>					
Ø	Stk. <sup>(1)</sup>		Ø	Stk. <sup>(1)</sup>				
mm	pc. <sup>(1)</sup>		mm	pc. <sup>(1)</sup>				
HSS COBALT GRIP			HSS COBALT GRIP					
Ø 1,00-10,00	0,5	1	Ø 1,00-13,00	0,5	1			

<sup>(1)</sup> Stück je Abmessung / Pieces each dimension / Piezas por diámetro



**D HSS Cobalt Spiralbohrer für INOX-Bleche und Hardox®**

**Einsatzbereich:**

Besonders geeignet für zähe und harte Werkstoffe wie rost- und säurebeständige Chrom-Nickelstähle, sowie sämtliche verschleißbeanspruchte Bauteile, überwiegend im Baugewerbe, wie z.B. HARDOX® 400 sowie XAR® 320 und XAR® 400 und ähnliche Werkstoffe.



Industriequalität  
Industrial quality  
Calidad industrial



Punktgenaues Anbohren  
Highly accurate centering  
Perforación de gran precisión

**E HSS Cobalt jobber drills for INOX sheet metals and Hardox®**

**Range of application:**

Specially suitable for drilling stainless steel, acid-resisting steel, spring-steel as well as extremely hard materials such as manganese steel, high-tensile fine grained machinery steel (e.g. HARDOX® 400, XAR® 320, XAR® 400) and similar materials.

**ES Broca espiral HSS Cobalt para chapas INOX & Hardox®**

**Ámbito de aplicación:**

Especialmente adecuadas para materiales tenaces y duros, como aceros al cromo-níquel que resisten los ácidos y la corrosión, así como elementos de mucho desgaste, principalmente en el campo de la construcción, como p. ej. HARDOX® 400 como XAR® 320 e XAR® 400 y otros materiales similares.

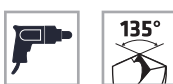

135°



Oberfläche: blank  
Surface: bright  
Superficie: brillante



Gewerbepack  
Industrial packing  
Paquete industrial

d1 mm	l1 mm	l2 mm	Code 638 Art.-Nr.	Inh. Cont.
2,00	49	12	0063800200100	10
2,50	57	14	0063800250100	10
3,00	61	16	0063800300100	10
3,20	65	18	0063800320100	10
3,30	65	19	0063800330100	10
3,50	70	20	0063800350100	10
4,00	75	22	0063800400100	10
4,20	75	22	0063800420100	10
4,50	80	24	0063800450100	10
5,00	86	26	0063800500100	10
5,50	93	28	0063800550100	10
6,00	93	28	0063800600100	10
6,50	101	31	0063800650100	10
6,80	101	31	0063800680100	10
7,00	109	34	0063800700100	10
7,50	109	34	0063800750100	5
8,00	117	37	0063800800100	5
8,50	117	37	0063800850100	5
9,00	125	40	0063800900100	5
9,50	125	40	0063800950100	5
10,00	133	43	0063801000100	5
10,20	133	43	0063801020100	5



Metal- und Edelstahlbohrer  
Metal drills and stainless steel drills  
broca para metal y broca de acero inoxidable

Gewerbepack  
*Industrial packing*  
*Paquete industrial*

d1 mm	l1 mm	l2 mm	Code 638 Art.-Nr.	Inh. Cont.
10,50	133	43	0063801050100	5
11,00	142	47	0063801100100	5
11,50	142	47	0063801150100	5
12,00	151	51	0063801200100	5
12,50	151	51	0063801250100	5
13,00	151	51	0063801300100	5

**D HSS Spiralbohrer mit Kreuzanschliff AC, kurz, DIN 338 RN**

**Einsatzbereich:**

Spiralbohrer präzisionsgeschliffen, Industriequalität zum Bohren von legierten und unlegierten Stählen, Grauguss, Temperguss, Kupferlegierungen, Neusilber, Graphit, Sinterisen.

**E HSS jobber drills with split point AC, DIN 338 RN**

**Range of application:**

Industrial quality twist drill for drilling steel and steel castings, alloyed carbon and plain steel, grey iron castings, copper-alloys, nickel-silver, graphite and similar materials.

**ES Broca espiral HSS con punta afilada en cruz AC, corta, DIN 338 RN**

**Ámbito de aplicación:**

Broca espiral afilada con precisión, calidad industrial para el taladrado de aceros aleados y no aleados, hierro fundido gris, fundición maleable, aleaciones de cobre, alpaca, grafito, hierro sinterizado.



Industriequalität  
Industrial quality  
Calidad industrial



Punktgenaues Anbohren  
Highly accurate centering  
Perforación de gran precisión



Präzise  
Precise  
Preciso



118°  
HSS  
DIN 338  
Typ / Type / Tipo RN  
5xd  
Kreuzanschliff Split Point AC  
Oberfläche: dampfangelassen  
Surface: steam tempered  
Superficie: templada al vapor



Gewerbepack  
Industrial packing  
Paquete industrial

d1 mm	l1 mm	l2 mm	Code 601 Art.-Nr.	Inh. Cont.
0,20	19	25	0060100020100	10
0,30	19	3	0060100030100	10
0,35	20	5	0060100035100	10
0,40	20	5	0060100040100	10
0,50	22	6	0060100050100	10
0,55	24	7	0060100055100	10
0,60	24	7	0060100060100	10
0,65	26	8	0060100065100	10
0,70	29	9	0060100070100	10
0,75	28	9	0060100075100	10
0,80	30	10	0060100080100	10
0,85	30	10	0060100085100	10
0,90	32	11	0060100090100	10
0,95	32	11	0060100095100	10
1,00	34	12	0060100100100	10
1,05	34	12	0060100105100	10
1,10	36	14	0060100110100	10
1,15	36	14	0060100115100	10
1,20	38	16	0060100120100	10
1,25	38	16	0060100125100	10
1,30	38	16	0060100130100	10
1,35	40	18	0060100135100	10



Metal- und Edelstahlbohrer  
Metal drills and stainless steel drills  
broca para metal y broca de acero inoxidable

Gewerbepack  
*Industrial packing*  
*Paquete industrial*

d1 mm	l1 mm	l2 mm	Code 601 Art.-Nr.	Inh. Cont.
1,40	40	18	0060100140100	10
1,45	40	18	0060100145100	10
1,50	40	18	0060100150100	10
1,55	43	20	0060100155100	10
1,60	43	20	0060100160100	10
1,65	43	20	0060100165100	10
1,70	43	20	0060100170100	10
1,75	46	22	0060100175100	10
1,80	46	22	0060100180100	10
1,85	46	22	0060100185100	10
1,90	46	22	0060100190100	10
1,95	49	24	0060100195100	10
2,00	49	24	0060100200100	10
2,05	49	24	0060100205100	10
2,10	49	24	0060100210100	10
2,15	53	27	0060100215100	10
2,20	53	27	0060100220100	10
2,25	53	27	0060100225100	10
2,30	53	27	0060100230100	10
2,35	53	27	0060100235100	10
2,40	57	30	0060100240100	10
2,45	57	30	0060100245100	10
2,50	57	30	0060100250100	10
2,55	57	30	0060100255100	10
2,60	57	30	0060100260100	10
2,65	57	30	0060100265100	10
2,70	61	33	0060100270100	10
2,75	61	33	0060100275100	10
2,80	61	33	0060100280100	10
2,85	61	33	0060100285100	10
2,90	61	33	0060100290100	10
2,95	61	33	0060100295100	10
3,00	61	33	0060100300100	10
3,10	65	36	0060100310100	10
3,20	65	36	0060100320100	10
3,25	65	36	0060100325100	10
3,30	65	36	0060100330100	10
3,40	70	39	0060100340100	10
3,50	70	39	0060100350100	10
3,60	70	39	0060100360100	10
3,70	70	39	0060100370100	10
3,75	70	39	0060100375100	10
3,80	75	43	0060100380100	10
3,90	75	43	0060100390100	10
4,00	75	43	0060100400100	10
4,10	75	43	0060100410100	10
4,20	75	43	0060100420100	10
4,25	75	43	0060100425100	10
4,30	80	47	0060100430100	10
4,40	80	47	0060100440100	10
4,50	80	47	0060100450100	10
4,60	80	47	0060100460100	10
4,70	80	47	0060100470100	10
4,75	80	47	0060100475100	10
4,80	86	52	0060100480100	10
4,90	86	52	0060100490100	10

Gewerbepack  
Industrial packing  
Paquete industrial

d1 mm	l1 mm	l2 mm	Code 601 Art.-Nr.	Inh. Cont.
5,00	86	52	0060100500100	10
5,10	86	52	0060100510100	10
5,20	86	52	0060100520100	10
5,25	86	52	0060100525100	10
5,30	86	52	0060100530100	10
5,40	93	57	0060100540100	10
5,50	93	57	0060100550100	10
5,60	93	57	0060100560100	10
5,70	93	57	0060100570100	10
5,75	93	57	0060100575100	10
5,80	93	57	0060100580100	10
5,90	93	57	0060100590100	10
6,00	93	57	0060100600100	10
6,10	101	63	0060100610100	10
6,20	101	63	0060100620100	10
6,25	101	63	0060100625100	10
6,30	101	63	0060100630100	10
6,40	101	63	0060100640100	10
6,50	101	63	0060100650100	10
6,60	101	63	0060100660100	10
6,70	101	63	0060100670100	10
6,75	109	69	0060100675100	10
6,80	109	69	0060100680100	10
6,90	109	69	0060100690100	10
7,00	109	69	0060100700100	10
7,10	109	69	0060100710100	10
7,20	109	69	0060100720100	10
7,25	109	69	0060100725100	10
7,30	109	69	0060100730100	10
7,40	109	69	0060100740100	10
7,50	109	69	0060100750100	10
7,60	117	75	0060100760100	10
7,70	117	75	0060100770100	10
7,75	117	75	0060100775100	10
7,80	117	75	0060100780100	10
7,90	117	75	0060100790100	10
8,00	117	75	0060100800100	10
8,10	117	75	0060100810100	10
8,20	117	75	0060100820100	10
8,25	117	75	0060100825100	10
8,30	117	75	0060100830100	10
8,40	117	75	0060100840100	10
8,50	117	75	0060100850100	10
8,60	125	81	0060100860100	10
8,70	125	81	0060100870100	10
8,75	125	81	0060100875100	10
8,80	125	81	0060100880100	10
8,90	125	81	0060100890100	10
9,00	125	81	0060100900100	10
9,10	125	81	0060100910100	10
9,20	125	81	0060100920100	10
9,25	125	81	0060100925100	10
9,30	125	81	0060100930100	10
9,40	125	81	0060100940100	10
9,50	125	81	0060100950100	10
9,60	133	87	0060100960100	10



Metal- und Edelstahlbohrer  
Metal drills and stainless steel drills  
broca para metal y broca de acero inoxidable

Gewerbepack  
*Industrial packing*  
*Paquete industrial*

d1 mm	l1 mm	l2 mm	Code 601 Art.-Nr.	Inh. Cont.
9,70	133	87	0060100970100	10
9,75	133	87	0060100975100	10
9,80	133	87	0060100980100	10
9,90	133	87	0060100990100	10
10,00	133	87	0060101000100	10
10,10	133	87	0060101010100	5
10,20	133	87	0060101020100	5
10,25	133	87	0060101025100	5
10,30	133	87	0060101030100	5
10,40	133	87	0060101040100	5
10,50	133	87	0060101050100	5
10,60	133	87	0060101060100	5
10,70	142	94	0060101070100	5
10,75	142	94	0060101075100	5
10,80	142	94	0060101080100	5
10,90	142	94	0060101090100	5
11,00	142	94	0060101100100	5
11,10	142	94	0060101110100	5
11,20	142	94	0060101120100	5
11,25	142	94	0060101125100	5
11,30	142	94	0060101130100	5
11,40	142	94	0060101140100	5
11,50	142	94	0060101150100	5
11,60	142	94	0060101160100	5
11,70	142	94	0060101170100	5
11,75	142	94	0060101175100	5
11,80	142	94	0060101180100	5
11,90	151	101	0060101190100	5
12,00	151	101	0060101200100	5
12,10	151	101	0060101210100	5
12,20	151	101	0060101220100	5
12,25	151	101	0060101225100	5
12,30	151	101	0060101230100	5
12,40	151	101	0060101240100	5
12,50	151	101	0060101250100	5
12,60	151	101	0060101260100	5
12,70	151	101	0060101270100	5
12,75	151	101	0060101275100	5
12,80	151	101	0060101280100	5
12,90	151	101	0060101290100	5
13,00	151	101	0060101300100	5
13,25	160	108	0060101325100	1
13,50	160	108	0060101350100	1
13,75	160	108	0060101375100	1
14,00	160	108	0060101400100	1
14,25	169	114	0060101425100	1
14,50	169	114	0060101450100	1
14,75	169	114	0060101475100	1
15,00	169	114	0060101500100	1
15,25	178	120	0060101525100	1
15,50	178	120	0060101550100	1
15,75	178	120	0060101575100	1
16,00	178	120	0060101600100	1
16,50	184	125	0060101650100	1
17,00	184	125	0060101700100	1
17,50	191	130	0060101750100	1

Gewerbepack  
*Industrial packing*  
*Paquete industrial*

d1 mm	l1 mm	l2 mm	Code 601 Art.-Nr.	Inh. Cont.
18,00	191	130	0060101800100	1
18,50	198	135	0060101850100	1
19,00	198	135	0060101900100	1
19,50	205	140	0060101950100	1
20,00	205	140	0060102000100	1



**Metall- und Edelstahlbohrer**  
*Metal drills and stainless steel drills*  
*broca para metal y broca de acero inoxidable*

**Für unser umfangreiches Sortiment an HSS- und VHM-Werkzeugen fordern Sie bitte den MAYKESTAG-Katalog an!**

*For our extensive range of HSS and solid carbide cutting tools please request the MAYKESTAG catalogue!*

*Si desea consultar la gama completa de herramientas HSS y VHM, solicite nuestro catálogo de MAYKESTAG.*

Kreuzanschliff  $\geq \varnothing 4,0$  mm / *Split Point  $\geq \varnothing 4,0$  mm* / *Punta afilada en cruz  $\geq \varnothing 4,0$  mm*

Oberfläche: dampfangelassen  $\geq \varnothing 1,0$  mm / *Surface: steam tempered  $\geq \varnothing 1,0$  mm* / *Superficie: templada al vapor  $\geq \varnothing 1,0$  mm*

🇩🇪 Kassetten, Sets

🇪🇸 Cassettes, sets

🇪🇸 Cajas, juegos

<p>HSS DIN 338 KM 19</p>   <p>19-tlg. / 19-pcs. / 19-unid. Metallkassette / Metal cassette / Caja de metal Art.-Nr. 0000101311100</p>			<p>HSS DIN 338 KM 25</p>   <p>25-tlg. / 25-pcs. / 25-unid. Metallkassette / Metal cassette / Caja de metal Art.-Nr. 0000101321100</p>			<p>HSS DIN 338 KM 50</p>   <p>50-tlg. / 50-pcs. / 50-unid. Metallkassette / Metal cassette / Caja de metal Art.-Nr. 0000100351100</p>		
Ø mm	 Stk. <sup>(1)</sup> pc. <sup>(1)</sup>		Ø mm	 Stk. <sup>(1)</sup> pc. <sup>(1)</sup>		Ø mm	 Stk. <sup>(1)</sup> pc. <sup>(1)</sup>	
HSS DIN 338			HSS DIN 338			HSS DIN 338		
Ø 1,00-10,00	0,5	1	Ø 1,00-13,00	0,5	1	Ø 1,00-5,90	0,1	1
<p>HSS DIN 338 KM 41</p>   <p>41-tlg. / 41-pcs. / 41-unid. Metallkassette / Metal cassette / Caja de metal Art.-Nr. 0000100361100</p>								
Ø mm	 Stk. <sup>(1)</sup> pc. <sup>(1)</sup>							
HSS DIN 338								
Ø 6,00-10,00	0,1	1						

<sup>(1)</sup> Stück je Abmessung / Pieces each dimension / Piezas por diámetro





**PRO**



**Spezialanschliff**

Kein Ankörnen erforderlich, weniger Vorschubdruck notwendig

**Special split point**

No center punching required, less feed pressure needed

**Punta afilada especial**

No es preciso el graneteado, necesita menor presión de avance

**Präzisionsgeschliffen**

**Precision ground**

**Afilada con precisión**

**Stahlqualität**

Hochwertigste HSS-Stahlqualität

**Steel grade**

Highest-quality HSS steel grade

**Calidad del acero**

Acero HSS de la más alta calidad

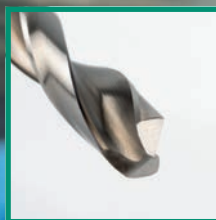

**alpen** *drill better.*

**① HSS Spiralbohrer, kurz, DIN 338 RN**

**Einsatzbereich:**

Präzisionsgeschliffener Spiralbohrer mit speziellem Kreuzanschliff, engen Toleranzen und hoher Rundlaufgenauigkeit. Zum Bearbeiten von legiertem und unlegiertem Stahl.

**② HSS jobber drills, DIN 338 RN**

**Range of application:**

HSS twist drill ground from solid, special split point. Bright finish: toughness and precision combined with excellent cutting efficiency for drilling alloyed carbon and plain steel.

**③ Broca espiral HSS, corta, DIN 338 RN**

**Ámbito de aplicación:**

Broca espiral afilada con precisión, con punta afilada en cruz especial, tolerancias estrechas y alta precisión de concentricidad. Para el procesamiento de acero aleado y no aleado.



Optimale Bohrleistung durch Spezialanschliff  
Optimum drilling performance thanks to a special point shape  
Óptima potencia de taladrado gracias a su punta afilada especial



Präzisionsgeschliffen  
Precision ground  
Afilada con precisión



Punktgenaues Anbohren  
Highly accurate centering  
Perforación de gran precisión



Einzelverpackung  
Single pack  
Embalaje individual



Gewerbepack  
Industrial packing  
Paquete industrial

d1 mm	d1 inch	l1 mm	l2 mm	Code 184 Art.-Nr.	Inh. Cont.		Code 954 Art.-Nr.	Inh. Cont.
1,00		34	12	0018400100100	1	10	0095400100100	10
1,10		36	14				0095400110100	10
1,19	3/64	38	16				0095400119100	10
1,20		38	16				0095400120100	10
1,30		38	16				0095400130100	10
1,40		40	18				0095400140100	10
1,50		40	18	0018400150100	1	10	0095400150100	10
1,59	1/16	43	20				0095400159100	10
1,60		43	20				0095400160100	10
1,70		43	20				0095400170100	10
1,80		46	22				0095400180100	10
1,90		49	24				0095400190100	10
1,98	5/64	49	24				0095400198100	10
2,00		49	24	0018400200100	1	10	0095400200100	10
2,10		49	24				0095400210100	10
2,20		53	27				0095400220100	10
2,30		53	27				0095400230100	10
2,38	3/32	57	30				0095400238100	10
2,40		57	30				0095400240100	10
2,50		57	30	0018400250100	1	10	0095400250100	10
2,60		57	30				0095400260100	10
2,70		61	33				0095400270100	10

				Einzelverpackung <i>Single pack</i> <i>Embalaje individual</i>			Gewerbepack <i>Industrial packing</i> <i>Paquete industrial</i>	
d1 mm	d1 inch	l1 mm	l2 mm	Code 184 Art.-Nr.	Inh. Cont.		Code 954 Art.-Nr.	Inh. Cont.
2,78	7/64	61	33				0095400278100	10
2,80		61	33				0095400280100	10
2,90		61	33				0095400290100	10
3,00		61	33	0018400300100	1	10	0095400300100	10
3,10		65	36				0095400310100	10
3,18	1/8	65	36				0095400318100	10
3,20		65	36	0018400320100	1	10	0095400320100	10
3,30		65	36	0018400330100	1	10	0095400330100	10
3,40		70	39				0095400340100	10
3,50		70	39	0018400350100	1	10	0095400350100	10
3,57	9/64	70	39				0095400357100	10
3,60		70	39				0095400360100	10
3,70		70	39				0095400370100	10
3,80		75	43				0095400380100	10
3,90		75	43				0095400390100	10
3,97	5/32	75	43				0095400397100	10
4,00		75	43	0018400400100	1	10	0095400400100	10
4,10		75	43				0095400410100	10
4,20		75	43	0018400420100	1	10	0095400420100	10
4,30		80	47				0095400430100	10
4,37	11/64	80	47				0095400437100	10
4,40		80	47				0095400440100	10
4,50		80	47	0018400450100	1	10	0095400450100	10
4,60		80	47				0095400460100	10
4,70		80	47				0095400470100	10
4,76	3/16	86	52				0095400476100	10
4,80		86	52	0018400480100	1	10	0095400480100	10
4,90		86	52				0095400490100	10
5,00		86	52	0018400500100	1	10	0095400500100	10
5,10		86	52				0095400510100	10
5,16	13/64	86	52				0095400516100	10
5,20		86	52				0095400520100	10
5,30		86	52				0095400530100	10
5,40		93	57				0095400540100	10
5,50		93	57	0018400550100	1	10	0095400550100	10
5,56	7/32	93	57				0095400556100	10
5,60		93	57				0095400560100	10
5,70		93	57				0095400570100	10
5,80		93	57				0095400580100	10
5,90		93	57				0095400590100	10
5,95	15/64	93	57				0095400595100	10
6,00		93	57	0018400600100	1	10	0095400600100	10
6,10		101	63				0095400610100	10
6,20		101	63				0095400620100	10
6,30		101	63				0095400630100	10
6,35	1/4	101	63				0095400635100	10
6,40		101	63				0095400640100	10
6,50		101	63	0018400650100	1	10	0095400650100	10
6,60		101	63				0095400660100	10
6,70		101	63				0095400670100	10
6,75	17/64	109	69				0095400675100	10
6,80		109	69	0018400680100	1	10	0095400680100	10
6,90		109	69				0095400690100	10
7,00		109	69	0018400700100	1	10	0095400700100	10
7,10		109	69				0095400710100	10
7,14	9/32	109	69				0095400714100	10



**Metall- und Edelstahlbohrer**  
Metal drills and stainless steel drills  
broca para metal y broca de acero inoxidable

				Einzelverpackung <i>Single pack</i> <i>Embalaje individual</i>			Gewerbepack <i>Industrial packing</i> <i>Paquete industrial</i>	
d1 mm	d1 inch	l1 mm	l2 mm	Code 184 Art.-Nr.	Inh. Cont.		Code 954 Art.-Nr.	Inh. Cont.
7,20		109	69				0095400720100	10
7,30		109	69				0095400730100	10
7,40		109	69				0095400740100	10
7,50		109	69	0018400750100	1	10	0095400750100	10
7,54	19/64	117	75				0095400754100	10
7,60		117	75				0095400760100	10
7,70		117	75				0095400770100	10
7,80		117	75				0095400780100	10
7,90		117	75				0095400790100	10
7,94	5/16	117	75				0095400794100	10
8,00		117	75	0018400800100	1	10	0095400800100	10
8,10		117	75				0095400810100	10
8,20		117	75				0095400820100	10
8,30		117	75				0095400830100	10
8,33	21/64	117	75				0095400833100	10
8,40		117	75				0095400840100	10
8,50		117	75	0018400850100	1	10	0095400850100	10
8,60		125	81				0095400860100	10
8,70		125	81				0095400870100	10
8,73	11/32	125	81				0095400873100	10
8,80		125	81				0095400880100	10
8,90		125	81				0095400890100	10
9,00		125	81	0018400900100	1	10	0095400900100	10
9,10		125	81				0095400910100	10
9,13	23/64	125	81				0095400913100	10
9,20		125	81				0095400920100	10
9,30		125	81				0095400930100	10
9,40		125	81				0095400940100	10
9,50		125	81	0018400950100	1	10	0095400950100	10
9,53	3/8	133	87				0095400953100	10
9,60		133	87				0095400960100	10
9,70		133	87				0095400970100	10
9,80		133	87				0095400980100	10
9,90		133	87				0095400990100	10
9,92	25/64	133	87				0095400992100	10
10,00		133	87	0018401000100	1	10	0095401000100	10
10,20		133	87	0018401020100	1	10	0095401020100	5
10,32	13/32	133	87				0095401032100	5
10,50		133	87	0018401050100	1	10	0095401050100	5
10,72	27/64	142	94				0095401072100	5
11,00		142	94	0018401100100	1	10	0095401100100	5
11,11	7/16	142	94				0095401111100	5
11,50		142	94	0018401150100	1	10	0095401150100	5
11,51	29/64	142	94				0095401151100	5
11,91	15/32	151	101				0095401191100	5
12,00		151	101	0018401200100	1	10	0095401200100	5
12,30	31/64	151	101				0095401230100	5
12,50		151	101	0018401250100	1	10	0095401250100	5
12,70	1/2	151	101				0095401270100	5
13,00		151	101	0018401300100	1	10	0095401300100	5

Kreuzanschliff  $\geq \varnothing 3,0$  mm / Split Point  $\geq \varnothing 3,0$  mm / Punta afilada en cruz  $\geq \varnothing 3,0$  mm

**D** HSS Spiralbohrer,  
ähnlich DIN 338 RN  
mit 1/4"-Sechskantschaft

**Einsatzbereich:**

Wie Code 184/954, zusätzlich passend für jeden Standard-Akkuschrauber und Universal-Halter (Bithalter) durch genormtes Schaftprofil. Spannung auch in konventionellen Bohrfuttern - kein Durchrutschen durch Sechskantschaft.



Schneller Bohrfortschritt  
Fast drilling progress  
Avance de perforación rápido



Punktgenaues Anbohren  
Highly accurate centering  
Perforación de gran precisión



Präzise  
Precise  
Preciso

**E** HSS jobber drills,  
sim. to DIN 338 RN  
with 1/4" hexagonal shank

**Range of application:**

Same as Code 184/954, additionally suitable for any standard cordless drill thanks to its standardized shank profile. Suitable for all universal holders (bit holders). Can also be clamped in conventional drill chucks - no slipping owing to the hexagonal shank.

**ES** Brocas espirales HSS  
semejantes a DIN 338 RN  
con eje hexagonal 1/4"

**Ámbito de aplicación:**

Igual que el código 184/954, apta además para todos los destornilladores a batería estándar y soportes universales (soporte de broca) gracias a su perfil de eje normativo. Tensión incluso en portabrocas convencionales, no se desliza gracias al eje hexagonal.



135°  
HSS

DIN 338

Cu  
Ms  
Ni  
Zn

Alu

Kreuzanschliff  
Split Point  
C

Oberfläche: blank  
Surface: bright  
Superficie: brillante

1/4"



Einzelverpackung  
Single pack  
Embalaje individual

d1 mm	l1 mm	l2 mm	Code 952 Art.-Nr.	Inh. Cont.	
2,00	62	24	0095200200100	1	10
3,00	74	33	0095200300100	1	10
4,00	88	43	0095200400100	1	10
5,00	100	52	0095200500100	1	10
6,00	107	57	0095200600100	1	10
8,00	117	75	0095200800100	1	10





















Metall- und Edelstahlbohrer  
Metal drills and stainless steel drills  
broca para metal y broca de acero inoxidable

Schaft nach DIN 3126, Form E6.3, ISO 1173 / Shank DIN 3126, Form E6.3, ISO 1173 / Eje según DIN 3126, forma E6.3, ISO 1173  
Kreuzanschliff ≥ Ø 3,0 mm / Split Point ≥ Ø 3,0 mm / Punta afilada en cruz ≥ Ø 3,0 mm

**D** Kassetten, Sets

**E** Cassettes, sets

**ES** Cajas, juegos

<p><b>PRO TM 6</b></p>   <p>6-tlg. / 6-pcs. / 6-unid. Kunststoffkassette / Plastic cassette / Caja de plástico Art.-Nr. 0000111806100</p>		<p><b>PRO ATM 4</b></p>   <p>4-tlg. / 4-pcs. / 4-unid. Kunststoffkassette / Plastic cassette / Caja de plástico Art.-Nr. 0000110804100</p>		<p><b>PRO APM 3</b></p>   <p>3-tlg. / 3-pcs. / 3-unid. Einzelverpackung / Single pack / Embalaje individual Art.-Nr. 0095200234100</p>	
<b>Ø</b>	<b>Stk. <sup>(1)</sup></b>	<b>Ø</b>	<b>Stk. <sup>(1)</sup></b>	<b>Ø</b>	<b>Stk. <sup>(1)</sup></b>
mm	pc. <sup>(1)</sup>	mm	pc. <sup>(1)</sup>	mm	pc. <sup>(1)</sup>
PRO		PRO		PRO	
Ø 2,00 / 3,00 / 4,00 / 5,00 / 6,00 / 8,00	1	Ø 2,00 / 3,00 / 4,00 / 5,00	1	Ø 2,00 / 3,00 / 4,00	1
<p><b>PRO ATM 6</b></p>   <p>6-tlg. / 6-pcs. / 6-unid. Kunststoffkassette / Plastic cassette / Caja de plástico Art.-Nr. 0000110806100</p>		<p><b>PRO KM 19</b></p>   <p>19-tlg. / 19-pcs. / 19-unid. Metallkassette / Metal cassette / Caja de metal Art.-Nr. 0000110311100</p>		<p><b>PRO KM 25</b></p>   <p>25-tlg. / 25-pcs. / 25-unid. Metallkassette / Metal cassette / Caja de metal Art.-Nr. 0000110321100</p>	
<b>Ø</b>	<b>Stk. <sup>(1)</sup></b>	<b>Ø</b>	 <b>Stk. <sup>(1)</sup></b>	<b>Ø</b>	 <b>Stk. <sup>(1)</sup></b>
mm	pc. <sup>(1)</sup>	mm	pc. <sup>(1)</sup>	mm	pc. <sup>(1)</sup>
PRO		PRO		PRO	
Ø 2,00 / 3,00 / 4,00 / 5,00 / 6,00 / 8,00	1	Ø 1,00-10,00	0,5	Ø 1,00-13,00	0,5
<p><b>PRO KP 19</b></p>   <p>19-tlg. / 19-pcs. / 19-unid. Kunststoffkassette / Plastic cassette / Caja de plástico Art.-Nr. 0000110319100</p>		<p><b>PRO KP 25</b></p>   <p>25-tlg. / 25-pcs. / 25-unid. Kunststoffkassette / Plastic cassette / Caja de plástico Art.-Nr. 0000110325100</p>			
<b>Ø</b>	 <b>Stk. <sup>(1)</sup></b>	<b>Ø</b>	 <b>Stk. <sup>(1)</sup></b>		
mm	pc. <sup>(1)</sup>	mm	pc. <sup>(1)</sup>		
PRO		PRO			
Ø 1,00-10,00	0,5	Ø 1,00-13,00	0,5		

<sup>(1)</sup> Stück je Abmessung / Pieces each dimension / Piezas por diámetro

**D HSS Spiralbohrer, kurz,  
DIN 338 RN**

**Einsatzbereich:**

Spiralbohrer präzisionsgeschliffen, mit engen Toleranzen und hoher Rundlaufgenauigkeit. Zum Bearbeiten von legiertem und unlegiertem Stahl.

**E HSS jobber drills,  
DIN 338 RN**

**Range of application:**

HSS twist drill ground from solid, bright finish: toughness and precision combined with excellent cutting efficiency for drilling alloyed carbon and plain steel.

**ES Broca espiral HSS, corta,  
DIN 338 RN**

**Ámbito de aplicación:**

Broca espiral afilada con precisión, con tolerancias estrechas y alta precisión de concentricidad. Para el procesamiento de acero aleado y no aleado.



Präzisionsgeschliffen  
Precision ground  
Afiada con precisión



Scharfe Schneiden  
Sharp cutting edges  
Filos bien afilados



Bruchstabil  
Break-resistant  
Resistente a la rotura

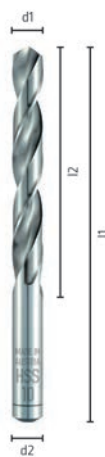

Einzelverpackung  
Single pack  
Embalaje individual



Gewerbepack  
Industrial packing  
Paquete industrial

d1 mm	d1 inch	l1 mm	l2 mm	Code 181 Art.-Nr.	Inh. Cont.		Code 951 Art.-Nr.	Inh. Cont.
1,00		34	12	0018100100100	3	10	0095100100100	10
1,10		36	14				0095100110100	10
1,19	3/64	38	16				0095100119100	10
1,20		38	16				0095100120100	10
1,30		38	16				0095100130100	10
1,40		40	18				0095100140100	10
1,50		40	18	0018100150100	3	10	0095100150100	10
1,59	1/16	43	20				0095100159100	10
1,60		43	20				0095100160100	10
1,70		43	20				0095100170100	10
1,80		46	22				0095100180100	10
1,90		49	24				0095100190100	10
1,98	5/64	49	24				0095100198100	10
2,00		49	24	0018100200100	3	10	0095100200100	10
2,10		49	24				0095100210100	10
2,20		53	27				0095100220100	10
2,30		53	27				0095100230100	10
2,38	3/32	57	30				0095100238100	10
2,40		57	30				0095100240100	10
2,50		57	30	0018100250100	3	10	0095100250100	10
2,60		57	30				0095100260100	10
2,70		61	33				0095100270100	10

				Einzelverpackung <i>Single pack</i> <i>Embalaje individual</i>			Gewerbepack <i>Industrial packing</i> <i>Paquete industrial</i>	
d1 mm	d1 inch	l1 mm	l2 mm	Code 181 Art.-Nr.	Inh. Cont.		Code 951 Art.-Nr.	Inh. Cont.
2,78	7/64	61	33				0095100278100	10
2,80		61	33				0095100280100	10
2,90		61	33				0095100290100	10
3,00		61	33	0018100300100	3	10	0095100300100	10
3,10		65	36				0095100310100	10
3,18	1/8	65	36				0095100318100	10
3,20		65	36	0018100320100	3	10	0095100320100	10
3,30		65	36	0018100330100	3	10	0095100330100	10
3,40		70	39				0095100340100	10
3,50		70	39	0018100350100	2	10	0095100350100	10
3,57	9/64	70	39				0095100357100	10
3,60		70	39				0095100360100	10
3,70		70	39				0095100370100	10
3,80		75	43				0095100380100	10
3,90		75	43				0095100390100	10
3,97	5/32	75	43				0095100397100	10
4,00		75	43	0018100400100	2	10	0095100400100	10
4,10		75	43				0095100410100	10
4,20		75	43	0018100420100	2	10	0095100420100	10
4,30		80	47				0095100430100	10
4,37	11/64	80	47				0095100437100	10
4,40		80	47				0095100440100	10
4,50		80	47	0018100450100	2	10	0095100450100	10
4,60		80	47				0095100460100	10
4,70		80	47				0095100470100	10
4,76	3/16	86	52				0095100476100	10
4,80		86	52	0018100480100	2	10	0095100480100	10
4,90		86	52				0095100490100	10
5,00		86	52	0018100500100	2	10	0095100500100	10
5,10		86	52				0095100510100	10
5,16	13/64	86	52				0095100516100	10
5,20		86	52				0095100520100	10
5,30		86	52				0095100530100	10
5,40		93	57				0095100540100	10
5,50		93	57	0018100550100	2	10	0095100550100	10
5,56	7/32	93	57				0095100556100	10
5,60		93	57				0095100560100	10
5,70		93	57				0095100570100	10
5,80		93	57				0095100580100	10
5,90		93	57				0095100590100	10
5,95	15/64	93	57				0095100595100	10
6,00		93	57	0018100600100	2	10	0095100600100	10
6,10		101	63				0095100610100	10
6,20		101	63				0095100620100	10
6,30		101	63				0095100630100	10
6,35	1/4	101	63				0095100635100	10
6,40		101	63				0095100640100	10
6,50		101	63	0018100650100	1	10	0095100650100	10
6,60		101	63				0095100660100	10
6,70		101	63				0095100670100	10
6,75	17/64	109	69				0095100675100	10
6,80		109	69	0018100680100	1	10	0095100680100	10
6,90		109	69				0095100690100	10
7,00		109	69	0018100700100	1	10	0095100700100	10
7,10		109	69				0095100710100	10
7,14	9/32	109	69				0095100714100	10



				Einzelverpackung <i>Single pack</i> <i>Embalaje individual</i>			Gewerbepack <i>Industrial packing</i> <i>Paquete industrial</i>	
d1 mm	d1 inch	l1 mm	l2 mm	Code 181 Art.-Nr.	Inh. Cont.		Code 951 Art.-Nr.	Inh. Cont.
7,20		109	69				0095100720100	10
7,30		109	69				0095100730100	10
7,40		109	69				0095100740100	10
7,50		109	69	0018100750100	1	10	0095100750100	10
7,54	19/64	117	75				0095100754100	10
7,60		117	75				0095100760100	10
7,70		117	75				0095100770100	10
7,80		117	75				0095100780100	10
7,90		117	75				0095100790100	10
7,94	5/16	117	75				0095100794100	10
8,00		117	75	0018100800100	1	10	0095100800100	10
8,10		117	75				0095100810100	10
8,20		117	75				0095100820100	10
8,30		117	75				0095100830100	10
8,33	21/64	117	75				0095100833100	10
8,40		117	75				0095100840100	10
8,50		117	75	0018100850100	1	10	0095100850100	10
8,60		125	81				0095100860100	10
8,70		125	81				0095100870100	10
8,73	11/32	125	81				0095100873100	10
8,80		125	81				0095100880100	10
8,90		125	81				0095100890100	10
9,00		125	81	0018100900100	1	10	0095100900100	10
9,10		125	81				0095100910100	10
9,13	23/64	125	81				0095100913100	10
9,20		125	81				0095100920100	10
9,30		125	81				0095100930100	10
9,40		125	81				0095100940100	10
9,50		125	81	0018100950100	1	10	0095100950100	10
9,53	3/8	133	87				0095100953100	10
9,60		133	87				0095100960100	10
9,70		133	87				0095100970100	10
9,80		133	87				0095100980100	10
9,90		133	87				0095100990100	10
9,92	25/64	133	87				0095100992100	10
10,00		133	87	0018101000100	1	10	0095101000100	10
10,20		133	87	0018101020100	1	10	0095101020100	5
10,32	13/32	133	87				0095101032100	5
10,50		133	87	0018101050100	1	10	0095101050100	5
10,72	27/64	142	94				0095101072100	5
11,00		142	94	0018101100100	1	10	0095101100100	5
11,11	7/16	142	94				0095101111100	5
11,50		142	94	0018101150100	1	10	0095101150100	5
11,51	29/64	142	94				0095101151100	5
11,91	15/32	151	101				0095101191100	5
12,00		151	101	0018101200100	1	10	0095101200100	5
12,30	31/64	151	101				0095101230100	5
12,50		151	101	0018101250100	1	10	0095101250100	5
12,70	1/2	151	101				0095101270100	5
13,00		151	101	0018101300100	1	10	0095101300100	5







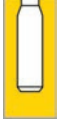

Metall- und Edelstahlbohrer  
Metal drills and stainless steel drills  
broca para metal y broca de acero inoxidable

🇩🇪 Kassetten, Sets

🇪🇸 Cassettes, sets

🇪🇸 Cajas, juegos

HSS Super TM 6		HSS Super KM 19		HSS Super KM 25	
					
6-tlg. / 6-pcs. / 6-unid. Kunststoffkassette / Plastic cassette / Caja de plástico Art.-Nr. 0000110806100		19-tlg. / 19-pcs. / 19-unid. Metallkassette / Metal cassette / Caja de metal Art.-Nr. 0000100311100		25-tlg. / 25-pcs. / 25-unid. Metallkassette / Metal cassette / Caja de metal Art.-Nr. 0000100321100	
Ø mm	Stk. <sup>(1)</sup> pc. <sup>(1)</sup>	Ø mm	 Stk. <sup>(1)</sup> pc. <sup>(1)</sup>	Ø mm	 Stk. <sup>(1)</sup> pc. <sup>(1)</sup>
HSS Super		HSS Super		HSS Super	
Ø 2,00 / 3,00 / 4,00 / 5,00 / 6,00 / 8,00	1	Ø 1,00-10,00	0,5	Ø 1,00-13,00	0,5

<sup>(1)</sup> Stück je Abmessung / Pieces each dimension / Piezas por diámetro



## SPRINT MASTER



### **Präzises Ergebnis**

Dank der scharfen Schneiden bedarf es wenig Vorschubdruck

### **Precise results**

Thanks to the sharp cutting edges it requires little feed pressure

### **Resultado preciso**

Gracias a sus filos afilados, necesita menos presión de avance

### **Hohe Elastizität**

Aufgrund höchster Zähigkeit wird die Bruchgefahr selbst bei kleinen Durchmessern stark verringert

### **High elasticity**

Due to highest toughness, the risk of breakage is greatly reduced even for small diameters

### **Alta elasticidad**

Gracias a su máxima tenacidad, reduce considerablemente el riesgo de rotura en diámetros pequeños.

### **Optimale Bohrleistung**

Garantiert eine schnelle, präzise Bohrung

### **Optimum drilling performance**

Guarantees fast, precise drilling

### **Capacidad de perforación óptima**

Garantiza una perforación rápida y precisa

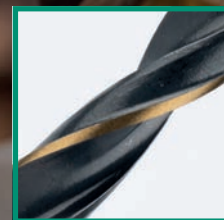
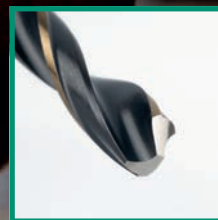

 **alpen** *drill better.*

**① HSS Spiralbohrer, kurz, DIN 338 RN**

**② HSS jobber drills, short DIN 338 RN**

**③ Broca espiral HSS, corta, DIN 338 RN**

**Einsatzbereich:**

Universeller Spiralbohrer, hohe Elastizität. Sehr gut geeignet für den Einsatz in Handbohrmaschinen, zum Bearbeiten von legiertem und unlegiertem Stahl.

**Range of application:**

HSS twist drill: toughness and precision combined with excellent cutting efficiency for drilling alloyed carbon and plain steel. Ideal for hand held operations.

**Ámbito de aplicación:**

Broca espiral universal con gran elasticidad. Muy adecuada para uso en taladros manuales, para el procesamiento de acero aleado y no aleado.



Elastisch  
Resilient  
Elástica



Schneller Bohrfortschritt  
Fast drilling progress  
Avance de perforación rápido



Lange Lebensdauer  
Long tool life  
Larga vida útil



Oberfläche: Sonderbehandlung  
Surface: Special treatment  
Superficie: Tratamiento especial



Einzelverpackung  
Single pack  
Embalaje individual

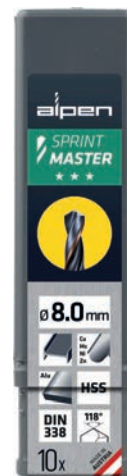

Gewerbepack  
Industrial packing  
Paquete industrial



Gewerbepack mit Aufhänger  
Industrial packing with tag  
Paquete industrial con gancho

d1 mm	d1 inch	l1 mm	l2 mm	Code 618 Art.-Nr.	Inh. Cont.	Inh. Cont.	Code 626 Art.-Nr.	Inh. Cont.	Code 631 Art.-Nr.	Inh. Cont.
0,40	1/64	20	5				0062600040100	10		
0,79	1/32	30	10				0062600079100	10		
1,00		34	12	0061800100100	3	10	0062600100100	10	0063100100100	10
1,10		36	14				0062600110100	10		
1,19	3/64	38	16				0062600119100	10		
1,20		38	16				0062600120100	10		
1,25		38	16				0062600125100	10		
1,30		38	16				0062600130100	10		
1,40		40	18				0062600140100	10		
1,50		40	18	0061800150100	3	10	0062600150100	10	0063100150100	10
1,59	1/16	43	20				0062600159100	10		
1,60		43	20				0062600160100	10		
1,70		43	20				0062600170100	10		
1,75		46	22				0062600175100	10		
1,80		46	22				0062600180100	10		
1,90		49	24				0062600190100	10		
1,98	5/64	49	24				0062600198100	10		
2,00		49	24	0061800200100	3	10	0062600200100	10	0063100200100	10
2,10		49	24				0062600210100	10		
2,20		53	27				0062600220100	10		
2,25		53	27				0062600225100	10		

NEW

				Einzelverpackung Single pack Embalaje individual			Gewerbepack Industrial packing Paquete industrial			Gewerbepack mit Aufhänger Industrial packing with tag Paquete industrial con gancho		
d1 mm	d1 inch	l1 mm	l2 mm	Code 618 Art.-Nr.	Inh. Cont.		Code 626 Art.-Nr.	Inh. Cont.	Code 631 Art.-Nr.	Inh. Cont.		
2,30		53	27				0062600230100	10				
2,38	3/32	57	30				0062600238100	10				
2,40		57	30				0062600240100	10				
2,50		57	30	0061800250100	3	10	0062600250100	10	0063100250100	10		
2,60		57	30				0062600260100	10				
2,70		61	33				0062600270100	10				
2,75		61	33				0062600275100	10				
2,78	7/64	61	33				0062600278100	10				
2,80		61	33				0062600280100	10				
2,90		61	33				0062600290100	10				
3,00		61	33	0061800300100	3	10	0062600300100	10	0063100300100	10		
3,10		65	36				0062600310100	10	0063100310100	10		
3,18	1/8	65	36				0062600318100	10				
3,20		65	36	0061800320100	3	10	0062600320100	10	0063100320100	10		
3,25		65	36				0062600325100	10				
3,30		65	36	0061800330100	3	10	0062600330100	10	0063100330100	10		
3,40		70	39				0062600340100	10				
3,50		70	39	0061800350100	2	10	0062600350100	10	0063100350100	10		
3,57	9/64	70	39				0062600357100	10				
3,60		70	39				0062600360100	10				
3,70		70	39				0062600370100	10				
3,75		70	39				0062600375100	10				
3,80		75	43				0062600380100	10				
3,90		75	43				0062600390100	10				
3,97	5/32	75	43				0062600397100	10				
4,00		75	43	0061800400100	2	10	0062600400100	10	0063100400100	10		
4,10		75	43				0062600410100	10	0063100410100	10		
4,20		75	43	0061800420100	2	10	0062600420100	10	0063100420100	10		
4,25		75	43				0062600425100	10				
4,30		80	47				0062600430100	10				
4,37	11/64	80	47				0062600437100	10				
4,40		80	47				0062600440100	10				
4,50		80	47	0061800450100	2	10	0062600450100	10	0063100450100	10		
4,60		80	47				0062600460100	10				
4,70		80	47				0062600470100	10				
4,75		80	47				0062600475100	10				
4,76	3/16	80	47				0062600476100	10				
4,80		86	52	0061800480100	2	10	0062600480100	10	0063100480100	10		
4,90		86	52				0062600490100	10				
5,00		86	52	0061800500100	2	10	0062600500100	10	0063100500100	10		
5,10		86	52				0062600510100	10				
5,16	13/64	86	52				0062600516100	10				
5,20		86	52				0062600520100	10				
5,25		86	52				0062600525100	10				
5,30		86	52				0062600530100	10				
5,40		93	57				0062600540100	10				
5,50		93	57	0061800550100	2	10	0062600550100	10	0063100550100	10		
5,56		93	57				0062600556100	10				
5,60		93	57				0062600560100	10				
5,70		93	57				0062600570100	10				
5,75		93	57				0062600575100	10				
5,80		93	57				0062600580100	10				
5,90		93	57				0062600590100	10				
5,95		93	57				0062600595100	10				
6,00		93	57	0061800600100	2	10	0062600600100	10	0063100600100	10		



Metall- und Edelstahlbohrer  
Metal drills and stainless steel drills  
broca para metal y broca de acero inoxidable

				Einzelverpackung Single pack Embalaje individual			Gewerbepack Industrial packing Paquete industrial		Gewerbepack mit Aufhänger Industrial packing with tag Paquete industrial con gancho	
d1 mm	d1 inch	l1 mm	l2 mm	Code 618 Art.-Nr.	Inh. Cont.		Code 626 Art.-Nr.	Inh. Cont.	Code 631 Art.-Nr.	Inh. Cont.
6,10		101	63				0062600610100	10		
6,20		101	63				0062600620100	10		
6,25		101	63				0062600625100	10		
6,30		101	63				0062600630100	10		
6,35	1/4	101	63				0062600635100	10		
6,40		101	63				0062600640100	10		
6,50		101	63	0061800650100	1	10	0062600650100	10	0063100650100	10
6,60		101	63				0062600660100	10		
6,70		101	63				0062600670100	10		
6,75		109	69				0062600675100	10		
6,80		109	69	0061800680100	1	10	0062600680100	10	0063100680100	10
6,90		109	69				0062600690100	10		
7,00		109	69	0061800700100	1	10	0062600700100	10	0063100700100	10
7,10		109	69				0062600710100	10		
7,14	9/32	109	69				0062600714100	10		
7,20		109	69				0062600720100	10		
7,25		109	69				0062600725100	10		
7,30		109	69				0062600730100	10		
7,40		109	69				0062600740100	10		
7,50		109	69	0061800750100	1	10	0062600750100	10	0063100750100	10
7,54	19/64	117	75				0062600754100	10		
7,60		117	75				0062600760100	10		
7,70		117	75				0062600770100	10		
7,75		117	75				0062600775100	10		
7,80		117	75				0062600780100	10		
7,90		117	75				0062600790100	10		
7,94		117	75				0062600794100	10		
8,00		117	75	0061800800100	1	10	0062600800100	10	0063100800100	10
8,10		117	75				0062600810100	10		
8,20		117	75				0062600820100	10		
8,25		117	75				0062600825100	10		
8,30		117	75				0062600830100	10		
8,33		117	75				0062600833100	10		
8,40		117	75				0062600840100	10		
8,50		117	75	0061800850100	1	10	0062600850100	10	0063100850100	10
8,60		125	81				0062600860100	10		
8,70		125	81				0062600870100	10		
8,73	11/32	125	81				0062600873100	10		
8,75		125	81				0062600875100	10		
8,80		125	81				0062600880100	10		
8,90		125	81				0062600890100	10		
9,00		125	81	0061800900100	1	10	0062600900100	10	0063100900100	10
9,10		125	81				0062600910100	10		
9,13	23/64	125	81				0062600913100	10		
9,20		125	81				0062600920100	10		
9,25		125	81				0062600925100	10		
9,30		125	81				0062600930100	10		
9,40		125	81				0062600940100	10		
9,50		125	81	0061800950100	1	10	0062600950100	10	0063100950100	10
9,53	3/8	133	87				0062600953100	10		
9,60		133	87				0062600960100	10		
9,70		133	87				0062600970100	10		
9,75		133	87				0062600975100	10		
9,80		133	87				0062600980100	10		
9,90		133	87				0062600990100	10		

				Einzelverpackung <i>Single pack</i> <i>Embalaje individual</i>			Gewerbepack <i>Industrial packing</i> <i>Paquete industrial</i>			Gewerbepack mit Aufhänger <i>Industrial packing with tag</i> <i>Paquete industrial con gancho</i>		
d1 mm	d1 inch	l1 mm	l2 mm	Code 618 Art.-Nr.	Inh. Cont.		Code 626 Art.-Nr.	Inh. Cont.	Code 631 Art.-Nr.	Inh. Cont.		
9,92	25/64	133	87				0062600992100	10				
10,00		133	87	0061801000100	1	10	0062601000100	10	0063101000100	10		
10,20		133	87	0061801020100	1	10	0062601020100	5				
10,25		133	87				0062601025100	5				
10,32	13/32	133	87				0062601032100	5				
10,50		133	87	0061801050100	1	10	0062601050100	5				
10,72	27/64	142	94				0062601072100	5				
10,75		142	94				0062601075100	5				
10,80		142	94				0062601080100	5				
11,00		142	94	0061801100100	1	10	0062601100100	5				
11,11	7/16	142	94				0062601111100	5				
11,20		142	94				0062601120100	5				
11,25		142	94				0062601125100	5				
11,50		142	94	0061801150100	1	10	0062601150100	5				
11,51	29/64	142	94				0062601151100	5				
11,75		142	94				0062601175100	5				
11,80		142	94				0062601180100	5				
11,91	15/32	151	101				0062601191100	5				
12,00		151	101	0061801200100	1	10	0062601200100	5				
12,20		151	101				0062601220100	5				
12,25		151	101				0062601225100	5				
12,30	31/64	151	101				0062601230100	5				
12,50		151	101	0061801250100	1	10	0062601250100	5				
12,70	1/2	151	101				0062601270100	5				
12,80		151	101				0062601280100	5				
13,00		151	101	0061801300100	1	10	0062601300100	5				
13,49	17/32	160	108				0062601349100	5				
13,50		160	108				0062601350100	5				
14,00		160	108				0062601400100	5				
14,28	9/16	169	114				0062601428100	5				
14,50		169	114				0062601450100	5				
15,00		169	114				0062601500100	5				
15,50		178	120				0062601550100	3				
15,87	5/8	178	120				0062601587100	3				
16,00		178	120				0062601600100	3				
16,50		184	125				0062601650100	3				
17,00		184	125				0062601700100	3				
17,46	11/16	184	125				0062601746100	3				
17,50		191	130				0062601750100	3				
18,00		191	130				0062601800100	3				
18,50		198	135				0062601850100	3				
19,00		198	135				0062601900100	3				
19,05	3/4	198	135				0062601905100	3				
19,50		205	140				0062601950100	3				
20,00		205	140				0062602000100	3				



Metall- und Edelstahlbohrer  
 Metal drills and stainless steel drills  
 broca para metal y broca de acero inoxidable

**D HSS Spiralbohrer,  
mit reduziertem Schaft,  
kurz, DIN 338 RN**

**Einsatzbereich:**

Universeller Spiralbohrer, hohe Elastizität. Sehr gut geeignet für den Einsatz in Handbohrmaschinen, zum Bearbeiten von legiertem und unlegiertem Stahl.

**E HSS jobber drills,  
with reduced shank,  
short, DIN 338 RN**

**Range of application:**

HSS twist drill: toughness and precision combined with excellent cutting efficiency for drilling alloyed carbon and plain steel. Ideal for hand held operations.

**ES Broca espiral HSS,  
con eje reducido,  
corta, DIN 338 RN**

**Ámbito de aplicación:**

Broca espiral universal con gran elasticidad. Muy adecuada para uso en taladros manuales, para el procesamiento de acero aleado y no aleado.



Elastisch  
Resilient  
Elástica



Schneller Bohrfortschritt  
Fast drilling progress  
Avance de perforación rápida



Lange Lebensdauer  
Long tool life  
Larga vida útil



Einzelverpackung  
Single pack  
Embalaje individual



Gewerbepack  
Industrial packing  
Paquete industrial

d1 mm	l1 mm	l2 mm	d2 mm	Code 640, 648 Art.-Nr.	Inh. Cont.		Code 642, 654 Art.-Nr.	Inh. Cont.
10,50	133	87	9,50	0064001050100	1	10	0064201050100	5
11,00	142	94	9,50	0064001100100	1	10	0064201100100	5
11,50	142	94	9,50	0064001150100	1	10	0064201150100	5
12,00	151	101	9,50	0064001200100	1	10	0064201200100	5
12,50	151	101	9,50	0064001250100	1	10	0064201250100	5
13,00	151	101	9,50	0064001300100	1	10	0064201300100	5
13,50	160	108	9,50	0064001350100	1	8	0064201350100	5
14,00	160	108	9,50	0064001400100	1	8	0064201400100	5
14,50	169	114	9,50	0064001450100	1	8	0064201450100	5
15,00	169	114	9,50	0064001500100	1	8	0064201500100	5
15,50	178	120	9,50	0064001550100	1	8	0064201550100	3
16,00	178	120	9,50	0064001600100	1	8	0064201600100	3
16,50	184	125	12,50	0064801650100	1	8	0065401650100	3
17,00	184	125	12,50	0064801700100	1	8	0065401700100	3
17,50	191	130	12,50	0064801750100	1	8	0065401750100	3
18,00	191	130	12,50	0064801800100	1	8	0065401800100	3
18,50	198	135	12,50	0064801850100	1	8	0065401850100	3
19,00	198	135	12,50	0064801900100	1	8	0065401900100	3
19,50	205	140	12,50	0064801950100	1	8	0065401950100	3
20,00	205	140	12,50	0064802000100	1	8	0065402000100	3



**D** Kassetten, Sets

**E** Cassettes, sets

**ES** Cajas, juegos

<p><b>Sprint Master TM 6</b></p>  <p>6-tlg. / 6-pcs. / 6-unid. Kunststoffkassette / Plastic cassette / Caja de plástico Art.-Nr. 0000811122100</p>			<p><b>Sprint Master TM 10</b></p>  <p>10-tlg. / 10-pcs. / 10-unid. Kunststoffkassette / Plastic cassette / Caja de plástico Art.-Nr. 0000811092100</p>			<p><b>Sprint Master TM 13/2</b></p>  <p>13-tlg. / 13-pcs. / 13-unid. Kunststoffkassette / Plastic cassette / Caja de plástico Art.-Nr. 0000811101100</p>		
<b>Ø</b> <b>mm</b>	<b>Stk.</b> <sup>(1)</sup> <b>pc.</b> <sup>(1)</sup>		<b>Ø</b> <b>mm</b>		<b>Stk.</b> <sup>(1)</sup> <b>pc.</b> <sup>(1)</sup>	<b>Ø</b> <b>mm</b>		<b>Stk.</b> <sup>(1)</sup> <b>pc.</b> <sup>(1)</sup>
Sprint Master			Sprint Master			Sprint Master		
Ø 2,00 / 3,00 / 4,00 / 5,00 / 6,00 / 8,00	1		Ø 1,00-10,00	1,0	1	Ø 1,50-6,50	0,5	1
						Sprint Master		
						Ø 3,20 / 4,80		1
<p><b>Sprint Master TM 13</b></p>  <p>13-tlg. / 13-pcs. / 13-unid. Kunststoffkassette / Plastic cassette / Caja de plástico Art.-Nr. 0000811102100</p>			<p><b>Sprint Master KM 19</b></p>  <p>19-tlg. / 19-pcs. / 19-unid. Metallkassette / Metal cassette / Caja de metal Art.-Nr. 0000810311100</p>			<p><b>Sprint Master KP 19</b></p>  <p>19-tlg. / 19-pcs. / 19-unid. Kunststoffkassette / Plastic cassette / Caja de plástico Art.-Nr. 0000812311100</p>		
<b>Ø</b> <b>mm</b>		<b>Stk.</b> <sup>(1)</sup> <b>pc.</b> <sup>(1)</sup>	<b>Ø</b> <b>mm</b>		<b>Stk.</b> <sup>(1)</sup> <b>pc.</b> <sup>(1)</sup>	<b>Ø</b> <b>mm</b>		<b>Stk.</b> <sup>(1)</sup> <b>pc.</b> <sup>(1)</sup>
Sprint Master			Sprint Master			Sprint Master		
Ø 2,00-8,00	0,5	1	Ø 1,00-10,00	0,5	1	Ø 1,00-10,00	0,5	1
<p><b>Sprint Master KM 21</b></p>  <p>21-tlg. / 21-pcs. / 21-unid. Metallkassette / Metal cassette / Caja de metal Art.-Nr. 0000810400100</p>			<p><b>Sprint Master KM 25</b></p>  <p>25-tlg. / 25-pcs. / 25-unid. Metallkassette / Metal cassette / Caja de metal Art.-Nr. 0000810321100</p>			<p><b>Sprint Master KP 25</b></p>  <p>25-tlg. / 25-pcs. / 25-unid. Kunststoffkassette / Plastic cassette / Caja de plástico Art.-Nr. 0000812321100</p>		
<b>Ø</b> <b>mm</b>		<b>Stk.</b> <sup>(1)</sup> <b>pc.</b> <sup>(1)</sup>	<b>Ø</b> <b>mm</b>		<b>Stk.</b> <sup>(1)</sup> <b>pc.</b> <sup>(1)</sup>	<b>Ø</b> <b>mm</b>		<b>Stk.</b> <sup>(1)</sup> <b>pc.</b> <sup>(1)</sup>
Sprint Master			Sprint Master			Sprint Master		
Ø 1,00-8,50	0,5	1	Ø 1,00-13,00	0,5	1	Ø 1,00-13,00	0,5	1
Ø 9,00-13,00	1,0							



Metall- und Edelstahlbohrer  
Metal drills and stainless steel drills  
broca para metal y broca de acero inoxidable

<sup>(1)</sup> Stück je Abmessung / Pieces each dimension / Piezas por diámetro

🇩🇪 Kassetten, Sets

🇪🇸 Cassettes, sets

🇪🇸 Cajas, juegos

Sprint Master KM 32			Sprint Master KM 50			Sprint Master KM 41		
								
32-tlg. / 32-pcs. / 32-unid. Metallkassette / Metal cassette / Caja de metal Art.-Nr. 0000810371100			50-tlg. / 50-pcs. / 50-unid. Metallkassette / Metal cassette / Caja de metal Art.-Nr. 0000810351100			41-tlg. / 41-pcs. / 41-unid. Metallkassette / Metal cassette / Caja de metal Art.-Nr. 0000810361100		
Ø mm		Stk. <sup>(1)</sup> pc. <sup>(1)</sup>	Ø mm		Stk. <sup>(1)</sup> pc. <sup>(1)</sup>	Ø mm		Stk. <sup>(1)</sup> pc. <sup>(1)</sup>
Sprint Master			Sprint Master			Sprint Master		
Ø 1,00-10,50	0,5	1	Ø 1,00-5,90	0,1	1	Ø 6,00-10,00	0,1	1
Ø 1,90 / 2,10 / 2,60 / 2,90 / 3,20 / 3,30 / 3,80 / 4,20 / 5,10 / 6,80 / 7,90 / 10,20		1						
Sprint Master KM 170			Sprint Master RDM 19					
								
170-tlg. / 170-pcs. / 170-unid. Metallkassette / Metal cassette / Caja de metal Art.-Nr. 0000810170100			19-tlg. / 19-pcs. / 19-unid. Runddose Art.-Nr. 0000810521100					
Ø mm		Stk. <sup>(1)</sup> pc. <sup>(1)</sup>	Ø mm		Stk. <sup>(1)</sup> pc. <sup>(1)</sup>			
Sprint Master			Sprint Master					
Ø 1,00-8,00	0,5	10	Ø 1,00-10,00	0,5	1			
Ø 8,50-10,00	0,5	5						

<sup>(1)</sup> Stück je Abmessung / Pieces each dimension / Piezas por diámetro

**D** Kassetten, Sets

**E** Cassettes, sets

**ES** Cajas, juegos

Combiset TM 9		Combiset TM 9/1		Combiset Master SET 16	
9-tlg. / 9-pcs. / 9-unid. Kunststoffkassette / Plastic cassette / Caja de plástico Art.-Nr. 0000802102100		9-tlg. / 9-pcs. / 9-unid. Kunststoffkassette / Plastic cassette / Caja de plástico Art.-Nr. 0000802122100		16-tlg. / 16-pcs. / 16-unid. Set Art.-Nr. 0000811003100	
Ø mm	Stk. (1) pc. (1)	Ø mm	Stk. (1) pc. (1)	Ø mm	Stk. (1) pc. (1)
Holz		Long Life		Holz	
Ø 5,00 / 6,00 / 8,00	1	Ø 4,00 / 5,00 / 6,00 / 8,00	1	Ø 4,00 / 5,00 / 6,00 / 8,00 / 10,00	1
Long Life		Sprint Master		Long Life	
Ø 5,00 / 6,00 / 8,00	1	Ø 3,00 / 4,00 / 5,00 / 6,00 / 8,00	1	Ø 4,00 / 5,00 / 6,00 / 8,00 / 10,00	1
Sprint Master				Sprint Master	
Ø 5,00 / 6,00 / 8,00	1			Ø 2,00 / 3,00 / 4,00 / 5,00 / 6,00 / 8,00	1
KIT SET 22		KIT SET 30			
22-tlg. / 22-pcs. / 22-unid. Set Art.-Nr. 0000800222100		30-tlg. / 30-pcs. / 30-unid. Set Art.-Nr. 0000800230100			
Ø mm	Stk. (1) pc. (1)	Ø mm	Stk. (1) pc. (1)		
Long Life		Holz			
Ø 5,00 / 6,00 / 8,00 / 10,00	1	Ø 4,00 / 5,00 / 6,00 / 8,00 / 10,00	1		
Sprint Master		HSS Super			
Ø 2,00 / 3,00 / 4,00 / 5,00 / 6,00 / 8,00 / 10,00	1	Ø 2,50 / 3,20	1		
Wera		Long Life			
9 Bits sortiert / 9 Bits sorted / 9 brocas surtidas		Ø 4,00 / 5,00 / 6,00 / 8,00 / 10,00	1		
Bitshalter / Bitholder / Portabrocas		Sprint Master			
Körner / Centerpunch / Punzón		Ø 3,00 / 4,00 / 5,00 / 6,00 / 8,00 / 10,00	1		
		Wera			
		9 Bits sortiert / 9 Bits sorted / 9 brocas surtidas			
		Bitshalter / Bitholder / Portabrocas			
		Körner / Centerpunch / Punzón			



Metall- und Edelstahlbohrer  
 Metal drills and stainless steel drills  
 broca para metal y broca de acero inoxidable

(1) Stück je Abmessung / Pieces each dimension / Piezas por diámetro

**1** HSS Spiralbohrer, lang, mit Kreuzanschliff AC, DIN 340 RN

**E** HSS long series drills with split point AC, DIN 340 RN

**ES** Broca espiral HSS, larga, con punta afilada en cruz AC, DIN 340 RN

**Einsatzbereich:**

Spiralbohrer präzisionsgeschliffen, Industriequalität zum Bohren von legierten und unlegierten Stählen, Grauguss, Temperguss, Kupferlegierungen, Neusilber, Graphit, Sinterisen.

**Range of application:**

Premium quality twist drill for drilling steel and steel castings, alloyed carbon and plain steel, grey iron castings, copper-alloys, nickel-silver, graphite and similar materials.

**Ámbito de aplicación:**

Broca espiral afilada con precisión, calidad industrial para el taladrado de aceros aleados y no aleados, hierro fundido gris, fundición maleable, aleaciones de cobre, alpaca, grafito, hierro sinterizado.



Industriequalität  
Industrial quality  
Calidad industrial



Punktgenaues Anbohren  
Highly accurate centering  
Perforación de gran precisión



Präzise  
Precise  
Preciso



118°

HSS

DIN 340

Typ/Type/Tipo  
RN

Kreuzanschliff  
Split Point  
AC

Oberfläche: dampfangelassen  
Surface: steam tempered  
Superficie: templado al vapor

10:d



Gewerbepack  
Industrial packing  
Paquete industrial

d1 mm	l1 mm	l2 mm	Code 501 Art.-Nr.	Inh. Cont.
0,50	32	12	0050100050100	10
0,60	35	15	0050100060100	10
0,70	42	21	0050100070100	10
0,80	46	25	0050100080100	10
1,00	56	33	0050100100100	10
1,10	60	37	0050100110100	10
1,20	65	41	0050100120100	10
1,30	65	41	0050100130100	10
1,40	70	45	0050100140100	10
1,50	70	45	0050100150100	10
1,60	76	50	0050100160100	10
1,70	76	50	0050100170100	10
1,80	80	53	0050100180100	10
1,90	80	53	0050100190100	10
2,00	85	56	0050100200100	10
2,10	85	56	0050100210100	10
2,20	90	59	0050100220100	10
2,30	90	59	0050100230100	10
2,40	95	62	0050100240100	10
2,50	95	62	0050100250100	10
2,60	95	62	0050100260100	10
2,70	100	66	0050100270100	10

Gewerbepack  
Industrial packing  
Paquete industrial

d1 mm	l1 mm	l2 mm	Code 501 Art.-Nr.	Inh. Cont.
2,80	100	66	0050100280100	10
2,90	100	66	0050100290100	10
3,00	100	66	0050100300100	10
3,10	106	69	0050100310100	10
3,20	106	69	0050100320100	10
3,30	106	69	0050100330100	10
3,40	112	73	0050100340100	10
3,50	112	73	0050100350100	10
3,60	112	73	0050100360100	10
3,70	112	73	0050100370100	10
3,80	119	78	0050100380100	10
3,90	119	78	0050100390100	10
4,00	119	78	0050100400100	10
4,10	119	78	0050100410100	10
4,20	119	78	0050100420100	10
4,30	126	82	0050100430100	10
4,40	126	82	0050100440100	10
4,50	126	82	0050100450100	10
4,60	126	82	0050100460100	10
4,70	126	82	0050100470100	10
4,80	132	87	0050100480100	10
4,90	132	87	0050100490100	10
5,00	132	87	0050100500100	10
5,10	132	87	0050100510100	10
5,20	132	87	0050100520100	10
5,30	132	87	0050100530100	10
5,40	139	91	0050100540100	10
5,50	139	91	0050100550100	10
5,60	139	91	0050100560100	10
5,70	139	91	0050100570100	10
5,80	139	91	0050100580100	10
5,90	139	91	0050100590100	10
6,00	139	91	0050100600100	10
6,10	148	97	0050100610100	10
6,20	148	97	0050100620100	10
6,30	148	97	0050100630100	10
6,40	148	97	0050100640100	10
6,50	148	97	0050100650100	10
6,60	148	97	0050100660100	10
6,70	148	97	0050100670100	10
6,80	156	102	0050100680100	10
6,90	156	102	0050100690100	10
7,00	156	102	0050100700100	10
7,10	156	102	0050100710100	10
7,20	156	102	0050100720100	10
7,30	156	102	0050100730100	10
7,40	156	102	0050100740100	10
7,50	156	102	0050100750100	10
7,60	165	109	0050100760100	10
7,70	165	109	0050100770100	10
7,80	165	109	0050100780100	10
7,90	165	109	0050100790100	10
8,00	165	109	0050100800100	10
8,20	165	109	0050100820100	10
8,50	165	109	0050100850100	10
8,80	175	115	0050100880100	10



Metall- und Edelstahlbohrer  
Metal drills and stainless steel drills  
broca para metal y broca de acero inoxidable

Gewerbepack  
Industrial packing  
Paquete industrial

d1 mm	l1 mm	l2 mm	Code 501 Art.-Nr.	Inh. Cont.
9,00	175	115	0050100900100	10
9,50	175	115	0050100950100	10
9,80	184	121	0050100980100	10
10,00	184	121	0050101000100	10
10,20	184	121	0050101020100	1
10,50	184	121	0050101050100	1
11,00	195	128	0050101100100	1
11,50	195	128	0050101150100	1
12,00	205	134	0050101200100	1
12,50	205	134	0050101250100	1
13,00	205	134	0050101300100	1
13,50	214	140	0050101350100	1
14,00	214	140	0050101400100	1
14,50	220	144	0050101450100	1
15,00	220	144	0050101500100	1
15,50	227	149	0050101550100	1
16,00	227	149	0050101600100	1

**Für unser umfangreiches Sortiment an HSS- und VHM-Werkzeugen fordern Sie bitte den MAYKESTAG-Katalog an!**

*For our extensive range of HSS and solid carbide cutting tools please request the MAYKESTAG catalogue!*

*Si desea consultar la gama completa de herramientas HSS y VHM, solicite nuestro catálogo de MAYKESTAG.*

Ø 0,50mm / Ø 0,60mm / Ø 0,70mm = WN / Split Point ≥ Ø 4,0 mm / Punta afilada en cruz ≥ Ø 4,0 mm  
Kreuzanschliff ≥ Ø 4,0 mm / Split Point ≥ Ø 4,0 mm / Punta afilada en cruz ≥ Ø 4,0 mm

**D HSS Spiralbohrer, lang, DIN 340 RN**

**Einsatzbereich:**

Spiralbohrer präzisionsgeschliffen, mit engen Toleranzen und hoher Rundlaufgenauigkeit. Zum Bearbeiten von legiertem und unlegiertem Stahl.

**E HSS long series drills, DIN 340 RN**

**Range of application:**

HSS twist drill ground from solid, bright finish: toughness and precision combined with excellent cutting efficiency for drilling alloyed carbon and plain steel.

**ES Broca espiral HSS, larga, DIN 340 RN**

**Ámbito de aplicación:**

Broca espiral afilada con precisión, con tolerancias estrechas y alta precisión de concentricidad. Para el procesamiento de acero aleado y no aleado.



Präzisionsgeschliffen  
Precision ground  
Afiada con precisión



Scharfe Schneiden  
Sharp cutting edges  
Filos bien afilados



Bruchstabil  
Break-resistant  
Resistente a la rotura



Einzelverpackung  
Single pack  
Embalaje individual



Gewerbepack  
Industrial packing  
Paquete industrial

d1 mm	l1 mm	l2 mm	Code 528 Art.-Nr.	Inh. Cont.		Code 551 Art.-Nr.	Inh. Cont.
1,00	56	33				0055100100100	10
1,50	70	45				0055100150100	10
2,00	85	56				0055100200100	10
2,50	95	62				0055100250100	10
3,00	100	66	0052800300100	1	10	0055100300100	10
3,20	106	69				0055100320100	10
3,50	112	73	0052800350100	1	10	0055100350100	10
4,00	119	78	0052800400100	1	10	0055100400100	10
4,20	119	78				0055100420100	10
4,50	126	82	0052800450100	1	10	0055100450100	10
5,00	132	87	0052800500100	1	10	0055100500100	10
5,50	139	91	0052800550100	1	10	0055100550100	10
6,00	139	91	0052800600100	1	10	0055100600100	10
6,50	148	97				0055100650100	10
7,00	156	102	0052800700100	1	10	0055100700100	10
8,00	165	109	0052800800100	1	10	0055100800100	10
9,00	175	115				0055100900100	10
10,00	184	121	0052801000100	1	10	0055101000100	10



Metall- und Edelstahlbohrer  
Metal drills and stainless steel drills  
broca para metal y broca de acero inoxidable

**① HSS Spiralbohrer, überlang,  
DIN 1869 R1 RN**

**Einsatzbereich:**

Hochleistungsbohrer zum Bohren von sehr tiefen Löchern, wobei Schnittgeschwindigkeit, Vorschub, Kühlung sowie häufige Span-entleerung zu beachten sind.

**② HSS extra long series drills,  
DIN 1869 R1 RN**

**Range of application:**

High efficiency drills for extremely deep holes where working conditions such as cutting speed, feed, coolant and frequent chip removal have to be observed.

**③ Broca espiral HSS, extra larga,  
DIN 1869 R1 RN**

**Ámbito de aplicación:**

Broca de alto rendimiento para el taladrado de agujeros muy profundos, en los que hay que tener en cuenta la velocidad de corte, el avance, la refrigeración y la eliminación frecuente de virutas.



Industriequalität  
Industrial quality  
Calidad industrial



Punktgenaues Anbohren  
Highly accurate centering  
Perforación de gran precisión



Präzise  
Precise  
Preciso



118°	HSS
DIN 1869	Typ / Type / Tipo RN
R1	10:d
Kreuzanschliff Split Point AC	
Oberfläche: dampfangelassen Surface: steam tempered Superficie: templada al vapor	



Einzelverpackung  
Single pack  
Embalaje individual



Einzelverpackung  
Single pack  
Embalaje individual

d1 mm	l1 mm	l2 mm	Code 100 Art.-Nr.	Inh. Cont.		Code 101 Art.-Nr.	Inh. Cont.
2,00	125	85				0010100200100	1
2,50	140	95				0010100250100	1
3,00	150	100	0010000300100	1	10	0010100300100	1
3,50	165	115	0010000350100	1	10	0010100350100	1
4,00	175	120	0010000400100	1	10	0010100400100	1
4,20	175	120				0010100420100	1
4,50	185	125				0010100450100	1
4,80	195	135				0010100480100	1
4,90	195	135				0010100490100	1
5,00	195	135	0010000500100	1	10	0010100500100	1
5,50	205	140				0010100550100	1
5,80	205	140				0010100580100	1
6,00	205	140	0010000600100	1	10	0010100600100	1
6,20	215	150				0010100620100	1
6,50	215	150				0010100650100	1
6,80	225	155				0010100680100	1
7,00	225	155				0010100700100	1
7,50	225	155				0010100750100	1
8,00	240	165	0010000800100	1	10	0010100800100	1
8,50	240	165				0010100850100	1
9,00	250	175				0010100900100	1
9,50	250	175				0010100950100	1



			Einzelverpackung <i>Single pack</i> <i>Embalaje individual</i>			Einzelverpackung <i>Single pack</i> <i>Embalaje individual</i>		
d1 mm	l1 mm	l2 mm	Code 100 Art.-Nr.	Inh. Cont.		Code 101 Art.-Nr.	Inh. Cont.	
10,00	265	185	0010001000100	1	10	0010101000100	1	
10,50	265	185				0010101050100	1	
11,00	280	195				0010101100100	1	
11,50	280	195				0010101150100	1	
12,00	295	205				0010101200100	1	
12,50	295	205				0010101250100	1	
13,00	295	205				0010101300100	1	



Metall- und Edelstahlbohrer  
Metal drills and stainless steel drills  
broca para metal y broca de acero inoxidable

① HSS Spiralbohrer, überlang, DIN 1869 R2 RN

② HSS extra long series drills, DIN 1869 R2 RN

③ Broca espiral HSS, extra larga, DIN 1869 R2 RN

**Einsatzbereich:**

Hochleistungsbohrer zum Bohren von sehr tiefen Löchern, wobei Schnittgeschwindigkeit, Vorschub, Kühlung sowie häufige Spanentleerung zu beachten sind.

**Range of application:**

High efficiency drills for extremely deep holes where working conditions such as cutting speed, feed, coolant and frequent chip removal have to be observed.

**Ámbito de aplicación:**

Broca de alto rendimiento para el taladrado de agujeros muy profundos, en los que hay que tener en cuenta la velocidad de corte, el avance, la refrigeración y la eliminación frecuente de virutas.



Industriequalität  
Industrial quality  
Calidad industrial



Punktgenaues Anbohren  
Highly accurate centering  
Perforación de gran precisión



Präzise  
Precise  
Preciso



118°	HSS
DIN 1869	Typ / Type / Tipo RN
R2	10:d
Kreuzanschliff Split Point AC	
Oberfläche: dampfangelassen Surface: steam tempered Superficie: templada al vapor	



Einzelverpackung  
Single pack  
Embalaje individual

d1 mm	l1 mm	l2 mm	Code 111 Art.-Nr.	Inh. Cont.
3,00	190	130	0011100300100	1
3,50	210	145	0011100350100	1
4,00	220	150	0011100400100	1
4,20	220	150	0011100420100	1
4,50	235	160	0011100450100	1
5,00	245	170	0011100500100	1
5,50	260	180	0011100550100	1
6,00	260	180	0011100600100	1
6,50	275	190	0011100650100	1
7,00	290	200	0011100700100	1
7,50	290	200	0011100750100	1
8,00	305	210	0011100800100	1
8,50	305	210	0011100850100	1
9,00	320	220	0011100900100	1
9,50	320	220	0011100950100	1
10,00	340	235	0011101000100	1
10,20	340	235	0011101020100	1
10,50	340	235	0011101050100	1
11,00	365	250	0011101100100	1
11,50	365	250	0011101150100	1
12,00	375	260	0011101200100	1
12,50	375	260	0011101250100	1
13,00	375	260	0011101300100	1

Für unser umfangreiches Sortiment an HSS- und VHM-Werkzeugen fordern Sie bitte den MAYKESTAG-Katalog an!  
For our extensive range of HSS and solid carbide cutting tools please request the MAYKESTAG catalogue!  
Si desea consultar la gama completa de herramientas HSS y VHM, solicite nuestro catálogo de MAYKESTAG.

**D HSS Spiralbohrer, überlang, DIN 1869 R3 RN**

**Einsatzbereich:**

Hochleistungsbohrer zum Bohren von sehr tiefen Löchern, wobei Schnittgeschwindigkeit, Vorschub, Kühlung sowie häufige Spanentleerung zu beachten sind.

**E HSS extra long series drills, DIN 1869 R3 RN**

**Range of application:**

High efficiency drills for extremely deep holes where working conditions such as cutting speed, feed, coolant and frequent chip removal have to be observed.

**ES Broca espiral HSS, extra larga, DIN 1869 R3 RN**

**Ámbito de aplicación:**

Broca de alto rendimiento para el taladrado de agujeros muy profundos, en los que hay que tener en cuenta la velocidad de corte, el avance, la refrigeración y la eliminación frecuente de virutas.



Industriequalität  
Industrial quality  
Calidad industrial



Punktgenaues Anbohren  
Highly accurate centering  
Perforación de gran precisión



Präzise  
Precise  
Preciso



118°	HSS
DIN 1869	Typ / Tipo / Tipo RN
R3	10:d
Kreuzanschliff Split Point AC	
Oberfläche: dampfangelassen Surface: steam tempered Superficie: templada al vapor	



Einzelverpackung  
Single pack  
Embalaje individual

d1 mm	l1 mm	l2 mm	Code 121 Art.-Nr.	Inh. Cont.
2,50	225	150	0012100250100	1
3,50	265	180	0012100350100	1
4,00	280	190	0012100400100	1
4,20	280	190	0012100420100	1
4,50	295	200	0012100450100	1
5,00	315	210	0012100500100	1
5,50	330	225	0012100550100	1
6,00	330	225	0012100600100	1
6,20	350	235	0012100620100	1
6,50	350	235	0012100650100	1
6,80	370	235	0012100680100	1
7,00	370	250	0012100700100	1
7,50	370	250	0012100750100	1
8,00	390	265	0012100800100	1
8,50	390	265	0012100850100	1
9,00	410	280	0012100900100	1
9,50	410	280	0012100950100	1
10,00	430	295	0012101000100	1
10,50	430	295	0012101050100	1
11,00	430	310	0012101100100	1
11,50	455	310	0012101150100	1
12,00	480	330	0012101200100	1
12,50	480	330	0012101250100	1
13,00	480	330	0012101300100	1

**Für unser umfangreiches Sortiment an HSS- und VHM-Werkzeugen fordern Sie bitte den MAYKESTAG-Katalog an!**  
For our extensive range of HSS and solid carbide cutting tools please request the MAYKESTAG catalogue!  
Si desea consultar la gama completa de herramientas HSS y VHM, solicite nuestro catálogo de MAYKESTAG.



Metall- und Edelstahlbohrer  
Metal drills and stainless steel drills  
broca para metal y broca de acero inoxidable

**D HSS Fassadenbohrer**

**E HSS facade drills**

**ES Brocas HSS para fachadas**

**Einsatzbereich:**

Spezialbohrer zum Bohren von allen üblichen Metallwerkstoffen sowie Hohlprofile aus Stahl, Kunststoff und Aluminium. Die kurze Spiralnut verhindert das Aufreiben der Bohrung bei Hohlprofilen. Speziell geeignet für Fassadenbau, Montage von Solar Photovoltaik Anlagen etc.

**Range of application:**

Special drill for drilling of all common metal materials and hollow profiles made of steel, plastics and aluminium. The short spiral flute prevents the reaming of the hole in hollow profiles. Especially suitable for facade construction, installation of solar photovoltaics systems, etc.

**Ámbito de aplicación:**

Broca especial para perforar todos los materiales metálicos habituales, así como perfiles huecos de acero, plástico y aluminio. La ranura en espiral corta impide que el orificio se escarie en perfiles huecos. Especialmente adecuada para la construcción de fachadas, el montaje de instalaciones de paneles solares fotovoltaicos, etc.



Präzise  
Precise  
Preciso



Scharfe Schneiden  
Sharp cutting edges  
Filos bien afilados



Bruchstabil  
Break-resistant  
Resistente a la rotura



120°  
HSS  
WN  
Cu  
Ms  
Ni  
Zn  
Alu  
Kreuzanschliff  
Split Point  
AC  
Oberfläche: dampfangelassen  
Surface: steam tempered  
Superficie: templado al vapor



Gewerbepack  
Industrial packing  
Paquete industrial

Länge / Length / Longitud: 150/30 mm

d1 mm	l1 mm	l2 mm	Code 123 Art.-Nr.	Inh. Cont.
4,00	150	30	0012300400100	5
4,50	150	30	0012300450100	5
5,00	150	30	0012300500100	5
5,30	150	30	0012300530100	5
5,50	150	30	0012300550100	5
5,70	150	30	0012300570100	5
5,80	150	30	0012300580100	5

Länge / Length / Longitud: 180/30 mm

d1 mm	l1 mm	l2 mm	Code 124 Art.-Nr.	Inh. Cont.
5,30	180	30	0012400530100	5
5,70	180	30	0012400570100	5
5,80	180	30	0012400580100	5
5,90	180	30	0012400590100	5

Gewerbepack  
Industrial packing  
Paquete industrial

**Länge / Length / Longitud: 200/30 mm**

d1 mm	l1 mm	l2 mm	Code 125 Art.-Nr.	Inh. Cont.
4,50	200	30	0012500450100	5
5,00	200	30	0012500500100	5
5,30	200	30	0012500530100	5
5,50	200	30	0012500550100	5
5,70	200	30	0012500570100	5
5,80	200	30	0012500580100	5
5,90	200	30	0012500590100	5
6,20	200	30	0012500620100	5
6,80	200	30	0012500680100	5
7,00	200	30	0012500700100	5

**Länge / Length / Longitud: 225/30 mm**

d1 mm	l1 mm	l2 mm	Code 126 Art.-Nr.	Inh. Cont.
6,80	225	30	0012600680100	5
7,00	225	30	0012600700100	5
7,20	225	30	0012600720100	5
7,40	225	30	0012600740100	5

**Länge / Length / Longitud: 300/30 mm**

d1 mm	l1 mm	l2 mm	Code 127 Art.-Nr.	Inh. Cont.
5,00	300	30	0012700500100	5
5,50	300	30	0012700550100	5
5,70	300	30	0012700570100	5
5,80	300	30	0012700580100	5
6,80	300	30	0012700680100	5
7,00	300	30	0012700700100	5



**Metall- und Edelstahlbohrer**  
Metal drills and stainless steel drills  
broca para metal y broca de acero inoxidable

**① HSS Cobalt  
Schweisspunktbohrer**

**⑤ HSS Cobalt  
spotweld drills**

**⑤ Broca para puntos de soldadura  
HSS Cobalt**

**Einsatzbereich:**

Spezialbohrer für Karoseriespengler. Zum einfachen Aufbohren von Schweißpunkten.

**Range of application:**

This high performance Spot Weld Drill possesses the ability to remove a spot weld without destroying the deeper sheet metal.

**Ámbito de aplicación:**

Broca especial para hojalateros. Para el taladrado sencillo de puntos de soldado.



Präzise  
Precise  
Preciso



Bruchstabil  
Break-resistant  
Resistente a la rotura



Industriequalität  
Industrial quality  
Calidad industrial



Oberfläche: blank  
Surface: bright  
Superficie: brillante



Einzelverpackung  
Single pack  
Embalaje individual



Einzelverpackung  
Single packing  
Embalaje individual



**TiN**  
Hohe Performance,  
lange Standzeit  
High performance,  
long durability  
Rendimiento elevado,  
duración prolongada

Einzelverpackung  
Single packing  
Embalaje individual

Länge / Length / Longitud: 80/38 mm

			blank / bright / brillante			blank / bright / brillante			TiN		
d1	l1	l2	Code 130	Inh.	Art.-Nr.	Code 330	Inh.	Art.-Nr.	Code 336	Inh.	Art.-Nr.
mm	mm	mm		Cont.			Cont.			Cont.	
6,00	80	38	0013000600100	1	10	0033000600100	1	10	0033600600100	1	10
8,00	80	38	0013000800100	1	10	0033000800100	1	10	0033600800100	1	10

**D HSS Spiralbohrer mit Morsekegel, DIN 345 RN**
**Einsatzbereich:**

Hochleistungsbohrer zum Bohren von legierten und unlegierten Stählen und Stahlguss, Grauguss, Temperguss, Kupferlegierungen, Neusilber, Graphit, Sintereisen.

**E HSS morse taper shank drills, DIN 345 RN**
**Range of application:**

Premium quality twist drills for drilling steel and steel castings, alloy and plain carbon, grey iron castings, copper-alloys, nickel-silver, graphite and similar materials.

**ES Broca espiral HSS con cono Morse, DIN 345 RN**
**Ámbito de aplicación:**

Broca espiral afilada con precisión, calidad industrial para el taladrado de aceros aleados y no aleados, hierro fundido gris, fundición maleable, aleaciones de cobre, alpaca, grafito, hierro sinterizado.



Industriequalität  
Industrial quality  
Calidad industrial



Bruchstabil  
Break-resistant  
Resistente a la rotura



Präzise  
Precise  
Preciso



Oberfläche: dampfangelassen  
Surface: steam tempered  
Superficie: templada al vapor



Einzelverpackung  
Single pack  
Embalaje individual

d1 mm	l1 mm	l2 mm	Code 202 Art.-Nr.	Inh. Cont.
5,00	133	52	0020200500100	1
5,50	138	57	0020200550100	1
6,00	138	57	0020200600100	1
6,50	144	63	0020200650100	1
7,00	150	69	0020200700100	1
7,50	150	69	0020200750100	1
8,00	156	75	0020200800100	1
8,50	156	75	0020200850100	1
9,00	162	81	0020200900100	1
9,50	162	81	0020200950100	1
9,80	168	87	0020200980100	1
10,00	168	87	0020201000100	1
10,20	168	87	0020201020100	1
10,25	168	87	0020201025100	1
10,50	168	87	0020201050100	1
10,75	175	94	0020201075100	1
11,00	175	94	0020201100100	1
11,25	175	94	0020201125100	1
11,50	175	94	0020201150100	1
11,75	175	94	0020201175100	1
12,00	182	101	0020201200100	1
12,25	182	101	0020201225100	1



Metall- und Edelstahlbohrer  
Metal drills and stainless steel drills  
broca para metal y broca de acero inoxidable

Einzelverpackung  
Single pack  
Embalaje individual

d1 mm	l1 mm	l2 mm	Code 202 Art.-Nr.	Inh. Cont.
12,50	182	101	0020201250100	1
12,75	182	101	0020201275100	1
13,00	182	101	0020201300100	1
13,25	189	108	0020201325100	1
13,50	189	108	0020201350100	1
13,75	189	108	0020201375100	1
14,00	189	108	0020201400100	1
14,25	212	114	0020201425100	1
14,50	212	114	0020201450100	1
14,75	212	114	0020201475100	1
15,00	212	114	0020201500100	1
15,25	218	120	0020201525100	1
15,50	218	120	0020201550100	1
15,75	218	120	0020201575100	1
16,00	218	120	0020201600100	1
16,25	223	125	0020201625100	1
16,50	223	125	0020201650100	1
16,75	223	125	0020201675100	1
17,00	223	125	0020201700100	1
17,25	228	130	0020201725100	1
17,50	228	130	0020201750100	1
17,75	228	130	0020201775100	1
18,00	228	130	0020201800100	1
18,25	233	135	0020201825100	1
18,50	233	135	0020201850100	1
18,75	233	135	0020201875100	1
19,00	233	135	0020201900100	1
19,25	238	140	0020201925100	1
19,50	238	140	0020201950100	1
19,75	238	140	0020201975100	1
20,00	238	140	0020202000100	1
20,25	243	145	0020202025100	1
20,50	243	145	0020202050100	1
20,75	243	145	0020202075100	1
21,00	243	145	0020202100100	1
21,25	248	150	0020202125100	1
21,50	248	150	0020202150100	1
21,75	248	150	0020202175100	1
22,00	248	150	0020202200100	1
22,25	248	150	0020202225100	1
22,50	253	155	0020202250100	1
22,75	253	155	0020202275100	1
23,00	253	155	0020202300100	1
23,50	276	155	0020202350100	1
23,75	281	160	0020202375100	1
24,00	281	160	0020202400100	1
24,50	281	160	0020202450100	1
24,75	281	160	0020202475100	1
25,00	281	160	0020202500100	1
25,25	286	165	0020202525100	1
25,50	286	165	0020202550100	1
25,75	286	165	0020202575100	1
26,00	286	165	0020202600100	1
26,50	286	165	0020202650100	1
27,00	291	170	0020202700100	1
27,50	291	170	0020202750100	1



Einzelverpackung  
Single pack  
Embalaje individual

d1 mm	l1 mm	l2 mm	Code 202 Art.-Nr.	Inh. Cont.
27,75	291	170	0020202775100	1
28,00	291	170	0020202800100	1
28,25	296	175	0020202825100	1
28,50	296	175	0020202850100	1
28,75	296	175	0020202875100	1
29,00	296	175	0020202900100	1
29,50	296	175	0020202950100	1
29,75	296	175	0020202975100	1
30,00	296	175	0020203000100	1
30,25	301	180	0020203025100	1
30,50	301	180	0020203050100	1
31,00	301	180	0020203100100	1
31,50	301	180	0020203150100	1
31,75	301	185	0020203175100	1
32,00	334	185	0020203200100	1
32,50	334	185	0020203250100	1
33,00	334	185	0020203300100	1
33,50	334	185	0020203350100	1
34,00	339	190	0020203400100	1
34,50	339	190	0020203450100	1
35,00	339	190	0020203500100	1
35,50	339	190	0020203550100	1
36,00	344	195	0020203600100	1
36,50	344	195	0020203650100	1
37,00	344	195	0020203700100	1
37,50	344	195	0020203750100	1
38,00	349	200	0020203800100	1
38,50	349	200	0020203850100	1
39,00	349	200	0020203900100	1
39,50	349	200	0020203950100	1
40,00	349	200	0020204000100	1
40,50	354	205	0020204050100	1
41,00	354	205	0020204100100	1
41,50	354	205	0020204150100	1
42,00	354	205	0020204200100	1
42,50	354	205	0020204250100	1
43,00	359	210	0020204300100	1
44,00	359	210	0020204400100	1
45,00	359	210	0020204500100	1
46,00	364	215	0020204600100	1
47,00	364	215	0020204700100	1
48,00	369	220	0020204800100	1
49,00	369	220	0020204900100	1
50,00	369	220	0020205000100	1
51,00	412	225	0020205100100	1
52,00	412	225	0020205200100	1
53,00	412	225	0020205300100	1
54,00	417	230	0020205400100	1
55,00	417	230	0020205500100	1
56,00	417	230	0020205600100	1
57,00	422	235	0020205700100	1
58,00	422	235	0020205800100	1
59,00	422	235	0020205900100	1
60,00	422	235	0020206000100	1
65,00	432	245	0020206500100	1
70,00	437	250	0020207000100	1



Metall- und Edelstahlbohrer  
Metal drills and stainless steel drills  
broca para metal y broca de acero inoxidable

**Für unser umfangreiches Sortiment an HSS- und VHM-Werkzeugen fordern Sie bitte den MAYKESTAG-Katalog an!**

*For our extensive range of HSS and solid carbide cutting tools please request the MAYKESTAG catalogue!*

*Si desea consultar la gama completa de herramientas HSS y VHM, solicite nuestro catálogo de MAYKESTAG.*

Anschliff Form A > Ø 16,0 bis Ø 40,00 mm, Anschliff Form AC ≤ Ø 16,0 mm / Point shape form A > Ø 16,0 to Ø 40,00 mm, Point shape form AC ≤ Ø 16,0 mm  
Punta afilada forma A > Ø 16,0 a Ø 40,00 mm, Punta afilada forma AC ≤ Ø 16,0 mm

**D** Drehzahlen und Vorschübe

**E** Spindle speeds and feeds

**ES** Velocidades y avances

Die angegebenen Schnittwertempfehlungen beziehen sich auf Standardanwendungen.

The recommended cutting data refer to standard applications.

Las recomendaciones indicadas de los valores de corte se refieren a aplicaciones estándar.

n: Drehzahl U/min  
f: Vorschub mm/U

n: Spindle speed rpm  
f: Feed mm/rev

n: Velocidad r.p.m.  
f: Avance mm/giro

**MAYKESTAG**



Code 100, 101, 111, 121, 123-127, 202, 501, 601

Ø mm														
	n	f	n	f	n	f	n	f	n	f	n	f	n	f
1.0	9549	0,03	7958	0,02	7003	0,01	6366	0,02	14324	0,02	14324	0,02	4775	0,04
1.5	6366	0,04	5305	0,02	4669	0,01	4244	0,03	9549	0,04	9549	0,04	3183	0,04
2.0	4775	0,05	3979	0,03	3501	0,02	3183	0,04	7162	0,05	7162	0,05	2387	0,05
2.5	3820	0,06	3183	0,04	2801	0,03	2546	0,05	5730	0,06	5730	0,06	1910	0,06
3.0	3183	0,07	2653	0,04	2334	0,03	2122	0,06	4775	0,08	4775	0,08	1592	0,06
3.2	2984	0,08	2487	0,05	2188	0,04	1989	0,06	4476	0,08	4476	0,08	1492	0,06
3.5	2728	0,09	2274	0,05	2001	0,04	1819	0,07	4093	0,09	4093	0,09	1364	0,07
4.0	2387	0,10	1989	0,06	1751	0,05	1592	0,08	3581	0,11	3581	0,11	1194	0,07
4.5	2122	0,11	1768	0,06	1556	0,05	1415	0,09	3183	0,12	3183	0,12	1061	0,08
4.8	1989	0,12	1658	0,07	1459	0,06	1326	0,10	2984	0,13	2984	0,13	995	0,08
5.0	1910	0,12	1592	0,07	1401	0,06	1273	0,10	2865	0,14	2865	0,14	955	0,08
5.5	1736	0,13	1447	0,08	1273	0,07	1157	0,11	2604	0,15	2604	0,15	868	0,09
6.0	1592	0,15	1326	0,08	1167	0,07	1061	0,12	2387	0,15	2387	0,15	796	0,10
6.5	1469	0,16	1224	0,09	1077	0,08	979	0,13	2204	0,16	2204	0,16	735	0,11
7.0	1364	0,17	1137	0,09	1000	0,08	909	0,14	2046	0,17	2046	0,17	682	0,12
7.5	1273	0,19	1061	0,10	934	0,09	849	0,15	1910	0,17	1910	0,17	637	0,13
8.0	1194	0,20	995	0,10	875	0,09	796	0,16	1790	0,18	1790	0,18	597	0,14
9.0	1061	0,21	884	0,11	778	0,10	707	0,17	1592	0,19	1592	0,19	531	0,16
10.0	955	0,23	796	0,13	700	0,11	637	0,18	1432	0,20	1432	0,20	477	0,17
12.0	796	0,25	663	0,16	584	0,14	531	0,20	1194	0,22	1194	0,22	398	0,20
14.0	682	0,28	568	0,18	500	0,16	455	0,23	1023	0,26	1023	0,26	341	0,23
16.0	597	0,30	497	0,20	438	0,18	398	0,25	895	0,30	895	0,30	298	0,25
18.0	531	0,32	442	0,21	389	0,19	354	0,27	796	0,32	796	0,32	265	0,26
20.0	477	0,35	398	0,22	350	0,20	318	0,28	716	0,35	716	0,35	239	0,27
Kühlung Coolant Refrigeración	E		E		E		T/D/E		E/O		E		E/W/A	

E: Emulsion | Emulsion | emulsión, O: Öl | Oil | aceite, T: trocken | dry | seco, D: Druckluft | compressed air | aire comprimido, W: Wasser | Water | agua, A: Luft | Air | Aire



## ① Drehzahlen und Vorschübe

## ② Spindle speeds and feeds

## ③ Velocidades y avances

Die angegebenen Schnittwertempfehlungen beziehen sich auf Standardanwendungen.

The recommended cutting data refer to standard applications.

Las recomendaciones indicadas de los valores de corte se refieren a aplicaciones estándar.

**n:** Drehzahl U/min  
**f:** Vorschub mm/U





**n:** Spindle speed rpm  
**f:** Feed mm/rev

**n:** Velocidad r.p.m.  
**f:** Avance mm/giro

### PRO / HSS Super



#### Code 181, 301, 311, 321, 331, 371, 528, 551, 951, 952, 954

Ø mm							GRAUGUSS CAST IRON GISHA CRICIA				Alu			
	n	f	n	f	n	f	n	f	n	f	n	f	n	f
1,0	7003	0,03	6048	0,02	5411	0,01	4775	0,02	10823	0,02	10823	0,02	4775	0,04
1,5	4669	0,04	4032	0,02	3608	0,01	3183	0,03	7215	0,04	7215	0,04	3183	0,04
2,0	3501	0,05	3024	0,03	2706	0,02	2387	0,04	5411	0,05	5411	0,05	2387	0,05
2,5	2801	0,06	2419	0,04	2165	0,03	1910	0,05	4329	0,06	4329	0,06	1910	0,06
3,0	2334	0,07	2016	0,04	1804	0,03	1592	0,06	3608	0,08	3608	0,08	1592	0,06
3,2	2188	0,08	1890	0,05	1691	0,04	1492	0,06	3382	0,08	3382	0,08	1492	0,06
3,5	2001	0,09	1728	0,05	1546	0,04	1364	0,07	3092	0,09	3092	0,09	1364	0,07
4,0	1751	0,10	1512	0,06	1353	0,05	1194	0,08	2706	0,11	2706	0,11	1194	0,07
4,5	1556	0,11	1344	0,06	1203	0,05	1061	0,09	2405	0,12	2405	0,12	1061	0,08
4,8	1459	0,12	1260	0,07	1127	0,06	995	0,10	2255	0,13	2255	0,13	995	0,08
5,0	1401	0,12	1210	0,07	1082	0,06	955	0,10	2165	0,14	2165	0,14	955	0,08
5,5	1273	0,13	1100	0,08	984	0,07	868	0,11	1968	0,15	1968	0,15	868	0,09
6,0	1167	0,15	1008	0,08	902	0,07	796	0,12	1804	0,15	1804	0,15	796	0,10
6,5	1077	0,16	930	0,09	833	0,08	735	0,13	1665	0,16	1665	0,16	735	0,11
7,0	1000	0,17	864	0,09	773	0,08	682	0,14	1546	0,17	1546	0,17	682	0,12
7,5	934	0,19	806	0,10	722	0,09	637	0,15	1443	0,17	1443	0,17	637	0,13
8,0	875	0,20	756	0,10	676	0,09	597	0,16	1353	0,18	1353	0,18	597	0,14
9,0	778	0,21	672	0,11	601	0,10	531	0,17	1203	0,19	1203	0,19	531	0,16
10,0	700	0,23	605	0,13	541	0,11	477	0,18	1082	0,20	1082	0,20	477	0,17
12,0	584	0,25	504	0,16	451	0,14	398	0,20	902	0,22	902	0,22	398	0,20
14,0	500	0,28	432	0,18	387	0,16	341	0,23	773	0,26	773	0,26	341	0,23
16,0	438	0,30	378	0,20	338	0,18	298	0,25	676	0,30	676	0,30	298	0,25
18,0	389	0,32	336	0,21	301	0,19	265	0,27	601	0,32	601	0,32	265	0,26
20,0	350	0,35	302	0,22	271	0,20	239	0,28	541	0,35	541	0,35	239	0,27
<b>Kühlung Coolant Refrigeración</b>	E		E		E		T/D/E		E/O		E		E/W/A	

E: Emulsion | Emulsion | emulsión, O: Öl | Oil | aceite, T: trocken | dry | seco, D: Druckluft | compressed air | aire comprimido, W: Wasser | Water | agua, A: Luft | Air | Aire

**D** Drehzahlen und Vorschübe

**E** Spindle speeds and feeds

**ES** Velocidades y avances

Die angegebenen Schnittwertempfehlungen beziehen sich auf Standardanwendungen.

The recommended cutting data refer to standard applications.

Las recomendaciones indicadas de los valores de corte se refieren a aplicaciones estándar.

n: Drehzahl U/min  
f: Vorschub mm/U

n: Spindle speed rpm  
f: Feed mm/rev







n: Velocidad r.p.m.  
f: Avance mm/giro

**HSS Sprint / Sprint Master**



Metall- und Edelstahlbohrer  
Metal drills and stainless steel drills  
broca para metal y broca de acero inoxidable

**Code 618, 626, 631, 640, 642, 648, 654, 734**

Ø mm	 <400 N/mm <sup>2</sup>		 <850 N/mm <sup>2</sup>		 <1.100 N/mm <sup>2</sup>		 CRAUCUSS CAST IRON GISHA CRICIA		 Cu Ms Ni Zn		 Alu			
	n	f	n	f	n	f	n	f	n	f	n	f	n	f
1,0	7003	0,03	6048	0,02	5411	0,01	4775	0,02	10823	0,02	10823	0,02	4775	0,04
1,5	4669	0,04	4032	0,02	3608	0,01	3183	0,03	7215	0,04	7215	0,04	3183	0,04
2,0	3501	0,05	3024	0,03	2706	0,02	2387	0,04	5411	0,05	5411	0,05	2387	0,05
2,5	2801	0,06	2419	0,04	2165	0,03	1910	0,05	4329	0,06	4329	0,06	1910	0,06
3,0	2334	0,07	2016	0,04	1804	0,03	1592	0,06	3608	0,08	3608	0,08	1592	0,06
3,2	2188	0,08	1890	0,05	1691	0,04	1492	0,06	3382	0,08	3382	0,08	1492	0,06
3,5	2001	0,09	1728	0,05	1546	0,04	1364	0,07	3092	0,09	3092	0,09	1364	0,07
4,0	1751	0,10	1512	0,06	1353	0,05	1194	0,08	2706	0,11	2706	0,11	1194	0,07
4,5	1556	0,11	1344	0,06	1203	0,05	1061	0,09	2405	0,12	2405	0,12	1061	0,08
4,8	1459	0,12	1260	0,07	1127	0,06	995	0,10	2255	0,13	2255	0,13	995	0,08
5,0	1401	0,12	1210	0,07	1082	0,06	955	0,10	2165	0,14	2165	0,14	955	0,08
5,5	1273	0,13	1100	0,08	984	0,07	868	0,11	1968	0,15	1968	0,15	868	0,09
6,0	1167	0,15	1008	0,08	902	0,07	796	0,12	1804	0,15	1804	0,15	796	0,10
6,5	1077	0,16	930	0,09	833	0,08	735	0,13	1665	0,16	1665	0,16	735	0,11
7,0	1000	0,17	864	0,09	773	0,08	682	0,14	1546	0,17	1546	0,17	682	0,12
7,5	934	0,19	806	0,10	722	0,09	637	0,15	1443	0,17	1443	0,17	637	0,13
8,0	875	0,20	756	0,10	676	0,09	597	0,16	1353	0,18	1353	0,18	597	0,14
9,0	778	0,21	672	0,11	601	0,10	531	0,17	1203	0,19	1203	0,19	531	0,16
10,0	700	0,23	605	0,13	541	0,11	477	0,18	1082	0,20	1082	0,20	477	0,17
12,0	584	0,25	504	0,16	451	0,14	398	0,20	902	0,22	902	0,22	398	0,20
14,0	500	0,28	432	0,18	387	0,16	341	0,23	773	0,26	773	0,26	341	0,23
16,0	438	0,30	378	0,20	338	0,18	298	0,25	676	0,30	676	0,30	298	0,25
18,0	389	0,32	336	0,21	301	0,19	265	0,27	601	0,32	601	0,32	265	0,26
20,0	350	0,35	302	0,22	271	0,20	239	0,28	541	0,35	541	0,35	239	0,27
<b>Kühlung Coolant Refrigeración</b>	E		E		E		T/D/E		E/O		E		E/W/A	

E: Emulsion | Emulsion | emulsión, O: Öl | Oil | aceite, T: trocken | dry | seco, D: Druckluft | compressed air | aire comprimido, W: Wasser | Water | agua, A: Luft | Air | Aire

① Spitzenanschliffe

② Point shapes

③ Puntas afiladas

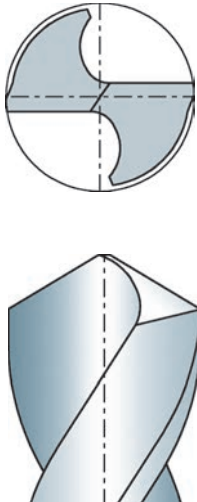
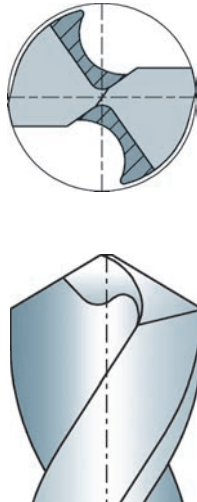
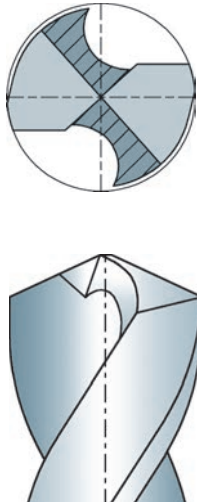
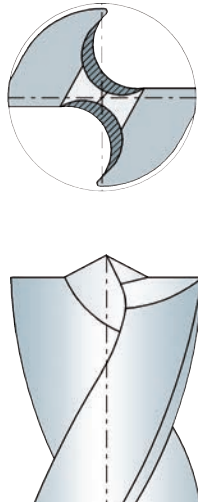
			
<p><b>Kegeomantelanschiff, 118°</b> Universeller Anschliff für viele Bohrarbeiten in Stahl- und Eisenwerkstoffen, Nichteisenmetallen, Kunststoffen und sonstigen Werkstoffen.</p> <p><b>Relieved cone, 118°</b> <i>Universal point-shape for a lot of drilling applications in steel and iron, non ferritic-materials, plastics and other materials.</i></p> <p><b>Punta afilada con superficie cónica, 118°</b> <i>Punta afilada universal para diversos trabajos de perforación en materiales de acero y hierro, metales no férricos, plásticos y otros materiales.</i></p>	<p><b>Kreuzanschiff AC, 118° bzw. 130°</b> Spezialanschiff für alle gängigen HSS Industriebohrer. Sehr gute Zentrierung und verbesserte Leistung durch die reduzierte Querschneide.</p> <p><b>Split Point AC, 118° or 130°</b> <i>Special point-shape for all common industrial drill bits. Very good centering and improved performance by the reduced cross-cutting.</i></p> <p><b>Punta afilada en cruz AC, 118° o 130°</b> <i>Punta afilada especial para todas las brocas industriales más frecuentes. Centrado excepcional y rendimiento mejorado gracias a la reducción del corte transversal.</i></p>	<p><b>Kreuzanschiff C, 130°/135°</b> Spezialanschiff für HSS Co5 Industriebohrer für die Zerspaltung von besonders zähen und harten Werkstoffen sowie nichtrostenden und Sonderwerkstoffen. Optimale Zentrierung und reduzierte Vorschubkraft durch maximale Querschneidenreduktion.</p> <p><b>Split Point C, 130°/135°</b> <i>Special point-shape for HSS Co5 industrial drill bits for the machining of particularly tough and hard materials as well as stainless steel and special materials. Optimal centering and reduced feed force by maximum cross-cutting reduction.</i></p> <p><b>Punta afilada en cruz C, 130°/135°</b> <i>Punta afilada especial para brocas industriales HSS Co5 para el virutaje de materiales especialmente blandos y duros, así como materiales inoxidables y especiales. Centrado óptimo y reducción de la fuerza de avance gracias a la reducción del corte transversal.</i></p>	<p><b>Zentrierspitze, Anschliff E, 180°</b> Spezialanschiff für Schweißpunktbohrer.</p> <p><b>Centering Point-Shape E, 180°</b> <i>Special point-shape for spot weld drills.</i></p> <p><b>Punta de centrado, punta afilada, tipo E, 180°</b> <i>Punta afilada especial para brocas para puntos de soldadura.</i></p>



**Metal- und Edelstahlbohrer**  
*Metal drills and stainless steel drills*  
*broca para metal y broca de acero inoxidable*



HOLZBOHRER























































🇪 DRILLS FOR  
WOOD

🇪S BROCAS PARA  
MADERA

Übersicht

Overview

Resumen

						
Norm / Estándar	WN	WN	WN			WN
Name / Nombre	HSS Cobalt	Profi Holz	Profi Holz	Holz	Form Lewis	SHARP SHARK
Schneidstoff / Cutting material / Material de corte	HSS-Co5	HSS	HSS	CV	CV	CV
Sonderanschliff / Special point shape / Punta afilada especial	B	C	B	B		
Schaft / Shank / Eje						
Ø mm	3,00 - 20,00	3,00 - 12,00	3,00 - 10,00	1,00 - 20,00	4,00 - 32,00	15,00 - 50,00
Code / Código	633	620	622	616	216, 226, 228	239
Seite / Page / Página	194	197	198	200	202	205
<b>Geeignet für / Suitable for / Adecuada para</b>						
 <b>Weichholz</b> Soft wood Madera blanda						
 <b>Hartholz</b> Hard wood Madera dura						
 <b>Holz gelemt</b> Flooring timbers Madera encolada						
 <b>Spanplatte</b> Chipboard Tabla de madera aglomerada						
 <b>Resopal</b> Laminated Chipboard Resopal						
 <b>Kunststoffe</b> Plastics Plástico						

Übersicht

Overview

Resumen

				
WN	WN	WN	WN	
Forstnerbohrer	BESCHLAGBOHRER	Holzbohrer	Holzbohrer	Flachfräsbohrer
CV	Hartmetall	CV	CV	CV
				
10,00 - 50,00	30,00 - 35,00	8,00 - 30,00	10,00 - 22,00	6,00 - 40,00
236	235	55, 65, 75	56, 66	234, 237-238
206	207	208	210	211
				
				
				
				
				



Holzbohrer  
wood drills  
brocas para madera

**① HSS Cobalt  
Maschinen-Holzspiralbohrer**

**② HSS Cobalt dowel drills**

**③ Broca espiral HSS Cobalt  
para madera**

**Einsatzbereich:**

5% kobaltlegierter Spiralbohrer mit sehr hoher thermischer Belastbarkeit. Hitzebeständig bis 650 °C. Zum Bohren von Weich- und Harthölzern, Spanplatten, Hartfaserplatten, zum Dübelbohren.

**Range of application:**

5% cobalt-alloyed jobber drills with high heat resistant up to 650 °C. For drilling in soft and hard wood, in chipboards, fibreboards, for drilling dowel holes.

**Ámbito de aplicación:**

Broca espiral HSS con 5% de aleación de cobalto y muy alta clasificación térmica. Termoestable hasta 650 °C. Adecuada para perforar maderas blandas y duras, tablas de madera aglomerada, tableros duros tratados, para perforar agujeros para espigas.



Hitzebeständig  
Heat resistant  
Termoestable



Scharfe Schneiden  
Sharp cutting edges  
Filos bien afilados



Punktgenaues Anbohren  
Highly accurate centering  
Perforación de gran precisión



HSS  
Co5

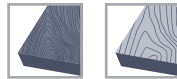

Oberfläche: blank  
Surface: bright  
Superficie: brillante



Einzelverpackung  
Single pack  
Embalaje individual





d1 mm	l1 mm	l2 mm	d2 mm	Code 633 Art.-Nr.	Inh. Cont.	
3,00	61	33		0063300300100	1	10
4,00	75	43		0063300400100	1	10
5,00	86	52		0063300500100	1	10
6,00	93	57		0063300600100	1	10
7,00	109	69		0063300700100	1	10
8,00	117	75		0063300800100	1	10
9,00	125	81		0063300900100	1	10
10,00	133	87		0063301000100	1	10
11,00	142	94	9,50	0063301100100	1	10
12,00	151	101	9,50	0063301200100	1	10
14,00	160	108	9,50	0063301400100	1	10
16,00	178	120	9,50	0063301600100	1	10
18,00	178	120	9,50	0063301800100	1	10
20,00	178	120	9,50	0063302000100	1	10

Form C Ø 5 mm, Form B < Ø 5 & ≥ 14 mm / Forma C Ø 5 mm, Forma B < Ø 5 & ≥ 14 mm

**D** Kassetten, Sets

**E** Cassettes, sets

**ES** Cajas, juegos

HSS Cobalt PCTM 5		HSS Cobalt PCTM 8	
			
5-tlg. / 5-pcs. / 5-unid. Kunststoffkassette / Plastic cassette / Caja de plástico Art.-Nr. 0063300005100		8-tlg. / 8-pcs. / 8-unid. Kunststoffkassette / Plastic cassette / Caja de plástico Art.-Nr. 0063300008100	
Ø mm	Stk. <sup>(1)</sup> pc. <sup>(1)</sup>	Ø mm	Stk. <sup>(1)</sup> pc. <sup>(1)</sup>
HSS Cobalt		HSS Cobalt	
Ø 4,00 / 5,00 / 6,00 / 8,00 / 10,00	1	Ø 3,00 / 4,00 / 5,00 / 10,00	1
		Ø 6,00 / 8,00	2



Holzbohrer  
wood drills  
brocas para madera

<sup>(1)</sup> Stück je Abmessung / Pieces each dimension / Piezas por diámetro



**PROFI HOLZ**



**Extra scharfe Schneiden**

Äußerst präzise  
Schneideeigenschaften dank  
der messerartig geschliffenen  
Vorschneiden

**Extra sharp cutting edges**

Extremely precise cutting performance  
thanks to the knife-edge ground pre-  
cutting edges

**Filos especialmente afilados**

Excepcionales y precisas propiedades de  
corte gracias a los filos afilados como  
un cuchillo

**Hitzebeständig**

Bohrungen bis 450° sind möglich

**Heat resistant**

Drilling up to 450° is possible

**Termoestable**

Posibilidad de perforaciones de hasta  
450°

**Exakte Bohrungen**

Die Doppelfase ermöglicht exakte  
Führung ohne Durchrutschen

**Precise drilling**

The double chamfer enables exact  
guidance without slipping

**Perforaciones exactas**

La doble fase permite una dirección  
exacta sin que se deslice



**alpen** *drill better.*

**D HSS Maschinen-Holzspiralbohrer**

**E HSS dowel drills**

**ES Brocas para madera HSS**

**Einsatzbereich:**

Hitzebeständig bis 450° C. Zum Bohren von Weich- und Harthölzern, Spanplatten, Hartfaserplatten, zum Dübellochbohren.

**Range of application:**

Heat resistant up to 450° C. For drilling in soft and hard wood, in chipboards, fibreboards, for drilling dowel holes.

**Ámbito de aplicación:**

Termoestable hasta 450 °C. Adecuada para perforar maderas blandas y duras, tablas de madera aglomerada, tableros duros tratados, para perforar agujeros para espigas.



Hitzebeständig  
Heat resistant  
Termoestable



Scharfe Schneiden  
Sharp cutting edges  
Filos bien afilados



Punktgenaues Anbohren  
Highly accurate centering  
Perforación de gran precisión

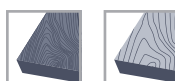

Oberfläche: blank  
Surface: bright  
Superficie: brillante



Einzelverpackung  
Single pack  
Embalaje individual

d1 mm	l1 mm	l2 mm	d2 mm	Code 620 Art.-Nr.	Inh. Cont.	
3,00	61	33		0062000300100	1	10
4,00	75	43		0062000400100	1	10
5,00	86	52		0062000500100	1	10
6,00	93	57		0062000600100	1	10
8,00	117	75		0062000800100	1	10
10,00	133	87		0062001000100	1	10
12,00	151	101	9,50	0062001200100	1	10



Holzbohrer  
wood drills  
brocas para madera

Form C Ø 5 mm, Form B < Ø 5 mm / Forma C Ø 5 mm, Forma B < Ø 5 mm

**① HSS Maschinen-Holzspiralbohrer mit 1/4"-Sechskantschaft**

**Einsatzbereich:**

Wie Code 620, zusätzlich passend für jeden Standard-Akkuschauber und Universal-Halter (Bithalter) durch genormtes Schaftprofil. Spannung auch in konventionellen Bohrfuttern - kein Durchrutschen durch Sechskantschaft.



Hitzebeständig  
Heat resistant  
Termoestable



Scharfe Schneiden  
Sharp cutting edges  
Filos bien afilados



Punktgenaues Anbohren  
Highly accurate centering  
Perforación de gran precisión

**② HSS dowel drills with 1/4"-hexagonal shank**

**Range of application:**

Same as code 620, additionally suitable for any standard cordless drill thanks to its standardized shank profile. Suitable for all universal holders (bit holders). Can also be clamped in conventional drill chucks - no slipping owing to the hexagonal shank.

**③ Brocas para madera HSS con eje hexagonal 1/4"**

**Ámbito de aplicación:**

Igual que el código 620, apta además para todos los destornilladores a batería estándar y soportes universales (soporte de broca) gracias a su perfil de eje normativo.

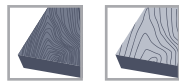
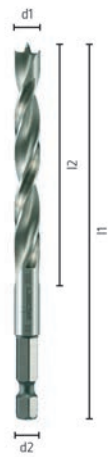

Oberfläche: blank  
Surface: bright  
Superficie: brillante



Einzelverpackung  
Single pack  
Embalaje individual

d1 mm	l1 mm	l2 mm	d2	Code 622 Art.-Nr.	Inh. Cont.	
3,00	74	33	1/4"	0062200300100	1	10
4,00	88	43	1/4"	0062200400100	1	10
5,00	100	52	1/4"	0062200500100	1	10
6,00	107	57	1/4"	0062200600100	1	10
8,00	117	75	1/4"	0062200800100	1	10
10,00	133	87	1/4"	0062201000100	1	10







Schaft nach DIN 3126, Form E6.3, ISO 1173 / Shank DIN 3126, Form E6.3, ISO 1173 / Eje según DIN 3126, forma E6.3, ISO 1173  
Form C Ø 5 mm, Form B < Ø 5 mm / Forma C Ø 5 mm, Forma B < Ø 5 mm



**D** Kassetten, Sets

**E** Cassettes, sets

**ES** Cajas, juegos

Profi Holz PTM 5		Profi Holz PTM 8		Profi Holz ATM 4	
					
5-tlg. / 5-pcs. / 5-unid. Kunststoffkassette / Plastic cassette / Caja de plástico Art.-Nr. 0000600114100		8-tlg. / 8-pcs. / 8-unid. Kunststoffkassette / Plastic cassette / Caja de plástico Art.-Nr. 0000600093100		4-tlg. / 4-pcs. / 4-unid. Kunststoffkassette / Plastic cassette / Caja de plástico Art.-Nr. 0000603002100	
Ø mm	Stk. <sup>(1)</sup> pc. <sup>(1)</sup>	Ø mm	Stk. <sup>(1)</sup> pc. <sup>(1)</sup>	Ø mm	Stk. <sup>(1)</sup> pc. <sup>(1)</sup>
Profi Holz		Profi Holz		Profi Holz	
Ø 4,00 / 5,00 / 6,00 / 8,00 / 10,00	1	Ø 3,00 / 4,00 / 5,00 / 10,00	1	Ø 3,00 / 4,00 / 5,00 / 6,00	1
		Ø 6,00 / 8,00	2		



Holzbohrer  
wood drills  
brocas para madera

<sup>(1)</sup> Stück je Abmessung / Pieces each dimension / Piezas por diámetro

① CV Maschinen-Holzspiralbohrer ② CV machine dowel drills

③ Brocas espirales para madera CV

**Einsatzbereich:**

Hitzebeständig bis 250° C. Zum Bohren von Weich- und Harthölzern, Spanplatten, Hartfaserplatten, zum Dübellochbohren.

**Range of application:**

Heat resistant up to 250° C. For drilling in soft and hard wood, in chipboards, fibreboards, for drilling dowel holes.

**Ámbito de aplicación:**

Termoestable hasta 250 °C. Adecuada para perforar maderas blandas y duras, tablas de madera aglomerada, tableros duros tratados, para perforar agujeros para espigas.



Punktgenaues Anbohren  
Highly accurate centering  
Perforación de gran precisión



Scharfe Schneiden  
Sharp cutting edges  
Filos bien afilados



CV

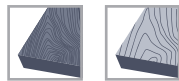

Oberfläche: Sonderbehandlung  
Surface: Special treatment  
Superficie: Tratamiento especial







Einzelverpackung  
Single pack  
Embalaje individual

d1 mm	l1 mm	l2 mm	d2 mm	Code 616 Art.-Nr.	Inh. Cont.	
1,00	61	33	3,00	0061600100100	2	10
2,00	61	33	3,00	0061600200100	2	10
3,00	61	33		0061600300100	1	10
4,00	75	43		0061600400100	1	10
5,00	86	52		0061600500100	1	10
6,00	93	57		0061600600100	1	10
7,00	109	69		0061600700100	1	10
8,00	117	75		0061600800100	1	10
9,00	125	81		0061600900100	1	10
10,00	133	87		0061601000100	1	10
11,00	142	84	9,50	0061601100100	1	10
12,00	151	101	9,50	0061601200100	1	10
13,00	151	101	9,50	0061601300100	1	10
14,00	160	108	9,50	0061601400100	1	8
15,00	169	114	9,50	0061601500100	1	8
16,00	178	120	9,50	0061601600100	1	8
18,00	178	120	9,50	0061601800100	1	8
20,00	178	120	9,50	0061602000100	1	8

**D** Kassetten, Sets

**E** Cassettes, sets

**ES** Cajas, juegos

Holz TM 5		Holz TM 8		KIT SET 30		
						
5-tlg. / 5-pcs. / 5-unid. Kunststoffkassette / Plastic cassette / Caja de plástico Art.-Nr. 0000600112100		8-tlg. / 8-pcs. / 8-unid. Kunststoffkassette / Plastic cassette / Caja de plástico Art.-Nr. 0000600092100		30-tlg. / 30-pcs. / 30-unid. Set Art.-Nr. 0000800230100		
Ø mm	Stk. <sup>(1)</sup> pc. <sup>(1)</sup>	Ø mm	Stk. <sup>(1)</sup> pc. <sup>(1)</sup>	Ø mm	Stk. <sup>(1)</sup> pc. <sup>(1)</sup>	
Holz		Holz		Holz		
Ø 4,00 / 5,00 / 6,00 / 8,00 / 10,00	1	Ø 3,00-10,00	1	Ø 4,00 / 5,00 / 6,00 / 8,00 / 10,00	1	
				HSS Super		
				Ø 2,50 / 3,20		1
				Long Life		
				Ø 4,00 / 5,00 / 6,00 / 8,00 / 10,00		1
				Sprint Master		
				Ø 3,00 / 4,00 / 5,00 / 6,00 / 8,00 / 10,00		1
				Wera		
				4 Bits sortiert / 4 Bits sorted / 4 brocas surtidas		
Combiset TM 9		Combiset Master SET 16				
						
9-tlg. / 9-pcs. / 9-unid. Kunststoffkassette / Plastic cassette / Caja de plástico Art.-Nr. 0000802102100		16-tlg. / 16-pcs. / 16-unid. Set Art.-Nr. 0000811003100				
Ø mm	Stk. <sup>(1)</sup> pc. <sup>(1)</sup>	Ø mm	Stk. <sup>(1)</sup> pc. <sup>(1)</sup>			
Holz		Holz				
Ø 5,00 / 6,00 / 8,00	1	Ø 4,00 / 5,00 / 6,00 / 8,00 / 10,00	1			
Long Life		Long Life				
Ø 5,00 / 6,00 / 8,00	1	Ø 4,00 / 5,00 / 6,00 / 8,00 / 10,00	1			
Sprint Master		Sprint Master				
Ø 5,00 / 6,00 / 8,00	1	Ø 2,00 / 3,00 / 4,00 / 5,00 / 6,00 / 8,00	1			



Holzbohrer  
wood drills  
brocas para madera

<sup>(1)</sup> Stück je Abmessung / Pieces each dimension / Piezas por diámetro

**CV Schlangenbohrer  
„Form Lewis“**

**CV auger bit  
“Form Lewis”**

**Broca salomónica CV  
“Forma Lewis”**

**Einsatzbereich:**

Zum Bohren von Kanthölzern und dicken Pfosten.

**Range of application:**

For drilling in square timbers and wood-jamb.

**Ámbito de aplicación:**

Para perforar maderas escuadradas y vigas gruesas.



Punktgenaues Anbohren  
Highly accurate centering  
Perforación de gran precisión



Scharfe Schneiden  
Sharp cutting edges  
Filos bien afilados

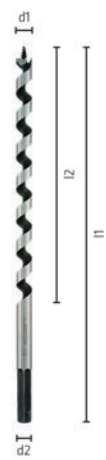

Oberfläche: Sonderbehandlung  
Surface: Special treatment  
Superficie: Tratamiento especial



Einzelverpackung  
Single pack  
Embalaje individual

NEW

d1 mm	l1 mm	l2 mm	d2 mm	Code 216 Art.-Nr.	Inh. Cont.	
4,00	180	100		0021600400100	1	1
5,00	235	160		0021600500100	1	1
6,00	235	160		0021600600100	1	1
8,00	235	160	7,00	0021600800100	1	1
10,00	235	160	9,00	0021601000100	1	1
12,00	235	160	11,00	0021601200100	1	1
14,00	235	160	13,00	0021601400100	1	1
15,00	235	160	13,00	0021601500100	1	1
16,00	235	160	13,00	0021601600100	1	1
18,00	235	160	13,00	0021601800100	1	1
20,00	235	160	13,00	0021602000100	1	1
22,00	235	160	13,00	0021602200100	1	1
24,00	235	160	13,00	0021602400100	1	1
25,00	235	160	13,00	0021602500100	1	1
26,00	235	160	13,00	0021602600100	1	1
28,00	235	160	13,00	0021602800100	1	1
30,00	235	160	13,00	0021603000100	1	1
32,00	235	160	13,00	0021603200100	1	1

Einzelverpackung  
*Single pack*  
*Embalaje individual*
**Länge / Length / Longitud: 460/380 mm**

d1 mm	l1 mm	l2 mm	d2 mm	Code 226 Art.-Nr.	Inh. Cont.	
8,00	460	380	7,00	0022600800100	1	1
10,00	460	380	9,00	0022601000100	1	1
12,00	460	380	11,00	0022601200100	1	1
14,00	460	380	12,00	0022601400100	1	1
16,00	460	380	12,00	0022601600100	1	1
18,00	460	380	12,00	0022601800100	1	1
20,00	460	380	12,00	0022602000100	1	1
22,00	460	380	12,00	0022602200100	1	1
24,00	460	380	12,00	0022602400100	1	1
25,00	460	380	12,00	0022602500100	1	1
26,00	460	380	12,00	0022602600100	1	1
28,00	460	380	12,00	0022602800100	1	1
30,00	460	380	12,00	0022603000100	1	1
32,00	460	380	12,00	0022603200100	1	1

**Länge / Length / Longitud: 600/530 mm**

d1 mm	l1 mm	l2 mm	d2 mm	Code 228 Art.-Nr.	Inh. Cont.	
10,00	600	530	9,00	0022801000100	1	1
12,00	600	530	11,00	0022801200100	1	1
14,00	600	530	12,00	0022801400100	1	1
16,00	600	530	12,00	0022801600100	1	1
18,00	600	530	12,00	0022801800100	1	1
20,00	600	530	12,00	0022802000100	1	1
22,00	600	530	12,00	0022802200100	1	1
24,00	600	530	12,00	0022802400100	1	1
26,00	600	530	12,00	0022802600100	1	1
28,00	600	530	12,00	0022802800100	1	1
30,00	600	530	12,00	0022803000100	1	1
32,00	600	530	12,00	0022803200100	1	1





 Holzbohrer  
 wood drills  
 brocas para madera

Sechskantschaft ≥ Ø 8,0 mm / Hexagonal shank ≥ Ø 8,0 mm / Eje hexagonal ≥ Ø 8,0 mm

① Kassetten, Sets

② Cassettes, sets

③ Cajas, juegos

Form Lewis Holzkassette 6			Form Lewis Holzkassette 6			Form Lewis Holzkassette 6		
								
<p>6-tlg. / 6-pcs. / 6-unid. Holzkassette / Wood cassette / Caja de madera Art.-Nr. 0021600006100</p>			<p>6-tlg. / 6-pcs. / 6-unid. Holzkassette / Wood cassette / Caja de madera Art.-Nr. 0022600006100</p>			<p>6-tlg. / 6-pcs. / 6-unid. Holzkassette / Wood cassette / Caja de madera Art.-Nr. 0028000006100</p>		
Ø mm	l1 mm	Stk. <sup>(1)</sup> pc. <sup>(1)</sup>	Ø mm	l1 mm	Stk. <sup>(1)</sup> pc. <sup>(1)</sup>	Ø mm	l1 mm	Stk. <sup>(1)</sup> pc. <sup>(1)</sup>
Form Lewis			Form Lewis			Form Lewis		
Ø 6,00 / 8,00 / 10,00 / 12,00 / 14,00 / 16,00	235	1	Ø 12,00 / 14,00 / 16,00 / 18,00 / 20,00 / 22,00	460	1	Ø 12,00 / 14,00 / 16,00 / 18,00 / 20,00 / 22,00	600	1

<sup>(1)</sup> Stück je Abmessung / Pieces each dimension / Piezas por diámetro

**D Maschinen-Forstnerbohrer mit 3-Flächenschaft „SHARP SHARK“**

**Einsatzbereich:**

Extrem scharfe Schneiden geben dem Werkzeug präzise Schneideigenschaften sowie eine extrem hohe Standzeit. Zum Bohren von Weich- und Harthölzern, Spanplatten und Hartfaserplatten.



Präzise  
Precise  
Preciso



Punktgenaues Anbohren  
Highly accurate centering  
Perforación de gran precisión



Scharfe Schneiden  
Sharp cutting edges  
Filos bien afilados

**E Machine forstner bit with 3-surface shank “SHARP SHARK”**

**Range of application:**

For drilling hard and soft woods, chip and fibreboards. Extreme sharp edges provide optimum performance and prolonged life.

**ES Broca fresadora para madera para máquinas con eje de 3 caras “SHARP SHARK”**

**Ámbito de aplicación:**

Filos extremadamente cortantes en el borde confieren a esta herramienta características de corte muy precisas, así como un tiempo de uso extremadamente prolongado. Para perforar maderas blandas y duras, tablas de madera aglomerada y tableros duros tratados.

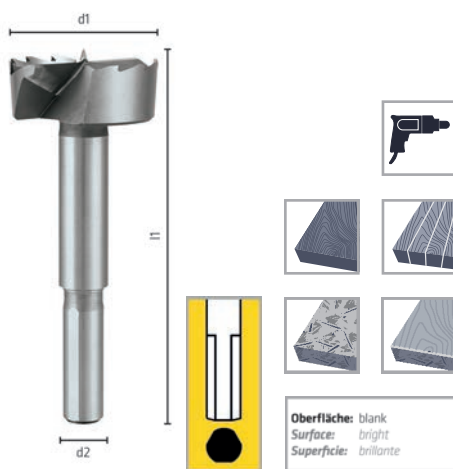

Oberfläche: blank  
Surface: bright  
Superficie: brillante



Drehpack mit Aufhänger  
Twistpack with tag  
Paquete giratorio con gancho para autoservicio

Länge / Length / Longitud: 90 mm

d1 mm	l1 mm	d2 mm	Code 239 Art.-Nr.	Inh. Cont.	
15,00	90	8,00	0023901500100	1	1
16,00	90	8,00	0023901600100	1	1
18,00	90	8,00	0023901800100	1	1
20,00	90	8,00	0023902000100	1	1
22,00	90	8,00	0023902200100	1	1
24,00	90	8,00	0023902400100	1	1
25,00	90	8,00	0023902500100	1	1
26,00	90	8,00	0023902600100	1	1
28,00	90	10,00	0023902800100	1	1
30,00	90	10,00	0023903000100	1	1
32,00	90	10,00	0023903200100	1	1
35,00	90	10,00	0023903500100	1	1
40,00	90	10,00	0023904000100	1	1
45,00	90	10,00	0023904500100	1	1
50,00	90	10,00	0023905000100	1	1

SHARP SHARK Holzkassette 5



5-tlg. / 5-pcs. / 5-unid.  
Holzkassette / Wood cassette / Caja de madera  
Art.-Nr. 0023900005100

Ø mm	Stk. <sup>(1)</sup> pc. <sup>(1)</sup>
SHARP SHARK	
Ø 15,00 / 20,00 / 25,00 / 30,00 / 35,00	1



Holzbohrer  
wood drills  
brocas para madera

<sup>(1)</sup> Stück je Abmessung / Pieces each dimension / Piezas por diámetro

① Maschinen-Forstnerbohrer

⑤ Machine forstner bit

⑤ Broca fresadora para madera para máquinas

**Einsatzbereich:**

Zum Bohren von Weich- und Harthölzern, Spanplatten und Hartfaserplatten.

**Range of application:**

For drilling in soft and hard wood, in chip-boards and fibreboards.

**Ámbito de aplicación:**

Para perforar maderas blandas y duras, tablas de madera aglomerada y tableros duros tratados.



Punktgenaues Anbohren  
Highly accurate centering  
Perforación de gran precisión



Scharfe Schneiden  
Sharp cutting edges  
Filos bien afilados

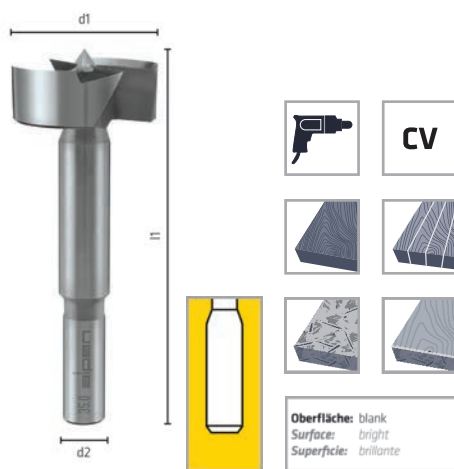

Oberfläche: blank  
Surface: bright  
Superficie: brillante



Drehpack mit Aufhänger  
Twistpack with tag  
Paquete giratorio con gancho para autoservicio

Länge / Length / Longitud: 90 mm

d1 mm	l1 mm	d2 mm	Code 236 Art.-Nr.	Inh. Cont.	
10,00	90	8,00	0023601000100	1	1
12,00	90	8,00	0023601200100	1	1
14,00	90	8,00	0023601400100	1	1
15,00	90	8,00	0023601500100	1	1
16,00	90	8,00	0023601600100	1	1
18,00	90	8,00	0023601800100	1	1
20,00	90	8,00	0023602000100	1	1
22,00	90	10,00	0023602200100	1	1
24,00	90	10,00	0023602400100	1	1
25,00	90	10,00	0023602500100	1	1
26,00	90	10,00	0023602600100	1	1
28,00	90	10,00	0023602800100	1	1
30,00	90	10,00	0023603000100	1	1
32,00	90	10,00	0023603200100	1	1
35,00	90	10,00	0023603500100	1	1
40,00	90	10,00	0023604000100	1	1
45,00	90	10,00	0023604500100	1	1
50,00	90	10,00	0023605000100	1	1



**D** Hartmetallbestückter  
Beschlagbohrer für  
Einbohrbänder

**Einsatzbereich:**

Zum Bohren von Harthölzer, Spanplatten und Hartfaserplatten. Einsatz nur mit Bohrständen.

**E** TCT drill bits for cantilever  
hinges

**Range of application:**

For drilling in hard wood, in chipboards and fibreboards. Use with drill stand only.

**ES** Broca para herrajes revestida de  
carburo metálico para brocas  
individuales

**Ámbito de aplicación:**

Para perforar maderas duras, tablas de madera aglomerada y tableros duros tratados. Solo emplear con un soporte para taladradora.



Verschleissfest  
Wear-resistant  
Resistente al desgaste



Punktgenaues Anbohren  
Highly accurate centering  
Perforación de gran precisión



Scharfe Schneiden  
Sharp cutting edges  
Filos bien afilados

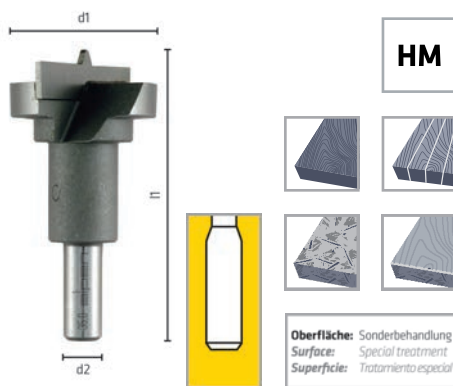

Drehpack mit Aufhänger  
Twistpack with tag  
Paquete giratorio con gancho para autoservicio

Länge / Length / Longitud: 57 mm

d1 mm	l1 mm	d2 mm	Code 235 Art.-Nr.	Inh. Cont.	
30,00	57	8,00	0023503000100	1	1
35,00	57	10,00	0023503500100	1	1



Holzbohrer  
wood drills  
brocas para madera

① Maschinen-Schalungsbohrer

⑤ Machine cavity wood drills

⑤ Broca para encofrados a máquina

**Einsatzbereich:**

Zum Bohren in Schalungen im Baubereich sowie von Brettern, Balken, Dielen und Platten aus Weich- und Hartholz u. ä.

**Range of application:**

For drilling through cavities in the building industry, also for drilling blanks, beams, joists and panels made of soft and hard wood.

**Ámbito de aplicación:**

Para perforar en encofrados en el sector de la construcción, así como para tablones, vigas, tablas de suelo y losas de madera y blanda y dura, etc.



Bruchstabil  
Break-resistant  
Resistente a la rotura



Scharfe Schneiden  
Sharp cutting edges  
Filos bien afilados

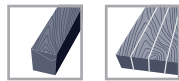
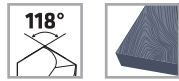

Oberfläche: Sonderbehandlung  
Surface: Special treatment  
Superficie: Tratamiento especial



Einzelverpackung  
Single pack  
Embalaje individual

Länge / Length / Longitud: 400/120 mm

d1 mm	l1 mm	l2 mm	d2 mm	Code 55 Art.-Nr.	Inh. Cont.	
8,00	400	120	6,00	0005500800100	1	1
10,00	400	120	8,00	0005501000100	1	1
12,00	400	120	8,00	0005501200100	1	1
14,00	400	120	8,00	0005501400100	1	1
16,00	400	120	10,00	0005501600100	1	1
18,00	400	120	10,00	0005501800100	1	1
20,00	400	120	10,00	0005502000100	1	1
22,00	400	120	10,00	0005502200100	1	1
24,00	400	120	11,00	0005502400100	1	1
26,00	400	120	11,00	0005502600100	1	1

Einzelverpackung  
Single pack  
Embalaje individual

Länge / Length / Longitud: 600/120 mm

d1 mm	l1 mm	l2 mm	d2 mm	Code 65 Art.-Nr.	Inh. Cont.	
8,00	600	120	6,00	0006500800100	1	1
10,00	600	120	8,00	0006501000100	1	1
12,00	600	120	8,00	0006501200100	1	1
14,00	600	120	8,00	0006501400100	1	1
16,00	600	120	10,00	0006501600100	1	1
18,00	600	120	10,00	0006501800100	1	1
20,00	600	120	10,00	0006502000100	1	1
22,00	600	120	10,00	0006502200100	1	1
24,00	600	120	11,00	0006502400100	1	1
26,00	600	120	11,00	0006502600100	1	1
30,00	600	120	11,00	0006503000100	1	1

Länge / Length / Longitud: 800/120 mm

d1 mm	l1 mm	l2 mm	d2 mm	Code 75 Art.-Nr.	Inh. Cont.	
10,00	800	120	8,00	0007501000100	1	1
12,00	800	120	8,00	0007501200100	1	1
14,00	800	120	8,00	0007501400100	1	1
16,00	800	120	10,00	0007501600100	1	1
18,00	800	120	10,00	0007501800100	1	1
20,00	800	120	10,00	0007502000100	1	1



Holzbohrer  
wood drills  
brocas para madera

**1 Maschinen-Schalungsbohrer mit SDS-plus Aufnahme**

**E Machine cavity wood drills with SDS-plus shank**

**ES Broca para encofrados para máquinas con toma SDS-plus**

**Einsatzbereich:**

Zum Bohren in Schalungen im Baubereich sowie von Brettern, Balken, Dielen und Platten aus Weich- und Hartholz u. ä.

**Range of application:**

For drilling through cavities in the building industry, also for drilling blanks, beams, joists and panels made of soft and hard wood.

**Ámbito de aplicación:**

Para perforar en encofrados en el sector de la construcción, así como para tablones, vigas, tablas de suelo y losas de madera y blanda y dura, etc.



**Bruchstabil**  
Break-resistant  
Resistente a la rotura



**Scharfe Schneiden**  
Sharp cutting edges  
Filos bien afilados

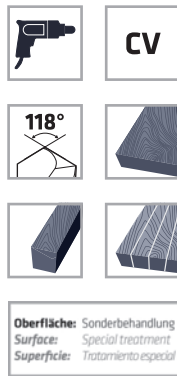

**Oberfläche:** Sonderbehandlung  
**Surface:** Special treatment  
**Superficie:** Tratamiento especial



Einzelverpackung  
Single pack  
Embalaje individual

**Länge / Length / Longitud: 400/120 mm**

d1 mm	l1 mm	l2 mm	d2	Code 56 Art.-Nr.	Inh. Cont.	
10,00	400	120	SDS-plus	0005601000100	1	1
12,00	400	120	SDS-plus	0005601200100	1	1
14,00	400	120	SDS-plus	0005601400100	1	1
16,00	400	120	SDS-plus	0005601600100	1	1
18,00	400	120	SDS-plus	0005601800100	1	1
20,00	400	120	SDS-plus	0005602000100	1	1
22,00	400	120	SDS-plus	0005602200100	1	1

**Länge / Length / Longitud: 600/120 mm**

d1 mm	l1 mm	l2 mm	d2	Code 66 Art.-Nr.	Inh. Cont.	
10,00	600	120	SDS-plus	0006601000100	1	1
12,00	600	120	SDS-plus	0006601200100	1	1
14,00	600	120	SDS-plus	0006601400100	1	1
16,00	600	120	SDS-plus	0006601600100	1	1
18,00	600	120	SDS-plus	0006601800100	1	1
20,00	600	120	SDS-plus	0006602000100	1	1
22,00	600	120	SDS-plus	0006602200100	1	1

**D** Flachfräsbohrer

**E** Flat wood bit

**ES** Broca fresadora plana

**Einsatzbereich:**

Schneller und exakter Schnitt, punktgenaues Anbohren. Zum Bohren in Weich- und Hartholz, Spanplatten und Balken.

**Range of application:**

Fast and precise cut, spot precision drilling. For drilling in soft and hard wood, chipboards and beams.

**Ámbito de aplicación:**

Corte rápido y exacto, perforación precisa. Para perforar maderas blandas y duras, tablas de madera aglomerada y vigas.



Punktgenaues Anbohren  
Highly accurate centering  
Perforación de gran precisión



Scharfe Schneiden  
Sharp cutting edges  
Filos bien afilados

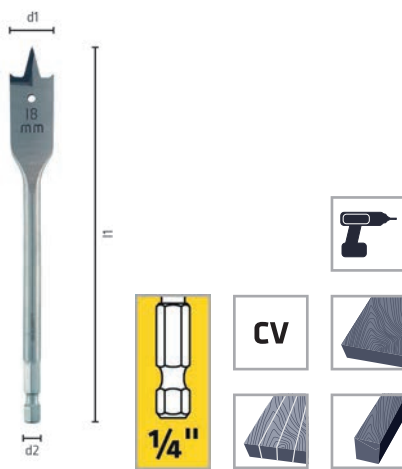

Einzelverpackung  
Single pack  
Embalaje individual

Länge / Length / Longitud: 152 mm

d1 mm	l1 mm	d2	Code 237 Art.-Nr.	Inh. Cont.	
6,00	152	1/4"	0023700600100	1	10
8,00	152	1/4"	0023700800100	1	10
10,00	152	1/4"	0023701000100	1	10
12,00	152	1/4"	0023701200100	1	10
13,00	152	1/4"	0023701300100	1	10
14,00	152	1/4"	0023701400100	1	10
16,00	152	1/4"	0023701600100	1	10
17,00	152	1/4"	0023701700100	1	10
18,00	152	1/4"	0023701800100	1	10
19,00	152	1/4"	0023701900100	1	10
20,00	152	1/4"	0023702000100	1	10
22,00	152	1/4"	0023702200100	1	10
24,00	152	1/4"	0023702400100	1	10
25,00	152	1/4"	0023702500100	1	10
26,00	152	1/4"	0023702600100	1	10
28,00	152	1/4"	0023702800100	1	10
30,00	152	1/4"	0023703000100	1	10
32,00	152	1/4"	0023703200100	1	10
35,00	152	1/4"	0023703500100	1	10
38,00	152	1/4"	0023703800100	1	10
40,00	152	1/4"	0023704000100	1	10



Holzbohrer  
wood drills  
brocas para madera

Länge / Length / Longitud: 400 mm			Einzelverpackung <i>Single pack</i> <i>Embalaje individual</i>		
d1 mm	l1 mm	d2	Code 238 Art.-Nr.	Inh. Cont.	
6,00	400	1/4"	0023800600100	1	10
8,00	400	1/4"	0023800800100	1	10
10,00	400	1/4"	0023801000100	1	10
12,00	400	1/4"	0023801200100	1	10
13,00	400	1/4"	0023801300100	1	10
14,00	400	1/4"	0023801400100	1	10
16,00	400	1/4"	0023801600100	1	10
17,00	400	1/4"	0023801700100	1	10
18,00	400	1/4"	0023801800100	1	10
20,00	400	1/4"	0023802000100	1	10
22,00	400	1/4"	0023802200100	1	10
24,00	400	1/4"	0023802400100	1	10
25,00	400	1/4"	0023802500100	1	10
26,00	400	1/4"	0023802600100	1	10
28,00	400	1/4"	0023802800100	1	10
30,00	400	1/4"	0023803000100	1	10
32,00	400	1/4"	0023803200100	1	10
35,00	400	1/4"	0023803500100	1	10
38,00	400	1/4"	0023803800100	1	10
40,00	400	1/4"	0023804000100	1	10

Einzelverpackung <i>Single pack / Embalaje individual</i>			Code 234 Art.-Nr.		
Zentrumsbohrer verstellbar bis ø 45 mm <i>Center bit adjustable up to ø 45 mm</i> <i>Broca de centrar ajustable hasta ø 45 mm</i>			0023404000100	1	10

Zubehör <i>Accessory / Accesorios</i>			Code 237 Art.-Nr.		
Verlängerung Flachfräsbohrer 300 mm <i>Extension flat drill file rasp 300 mm</i> <i>Prolongación de broca fresadora plana 300 mm</i>			0023709999100	1	10







Schaft nach DIN 3126, Form E6.3, ISO 1173 / Shank DIN 3126, Form E6.3, ISO 1173 / Eje según DIN 3126, forma E6.3, ISO 1173

**D** Kassetten, Sets

**E** Cassettes, sets

**ES** Cajas, juegos

Flachfräsbohrer BOX 5		Flachfräsbohrer PLT 3	
			
5-tlg. / 5-pcs. / 5-unid. Kunststoffbox / Plastic box / Caja de plástico Art.-Nr. 0023700015100		3-tlg. / 3-pcs. / 3-unid. Einzelverpackung / Single pack / Embalaje individual Art.-Nr. 0023700003100	
Ø mm	Stk. <sup>(1)</sup> pc. <sup>(1)</sup>	Ø mm	Stk. <sup>(1)</sup> pc. <sup>(1)</sup>
Flachfräsbohrer Ø 16,00 / 18,00 / 20,00 / 22,00 / 24,00	1	Flachfräsbohrer Ø 16,00 / 18,00 / 20,00	1



Holzbohrer  
wood drills  
brocas para madera

<sup>(1)</sup> Stück je Abmessung / Pieces each dimension / Piezas por diámetro

① Drehzahlen

② Spindle speeds

③ Velocidades

Die angegebenen Schnittwertempfehlungen beziehen sich auf Standardanwendungen.

The recommended cutting data refer to standard applications.

Las recomendaciones indicadas de los valores de corte se refieren a aplicaciones estándar.





HSS Cobalt Holz





Profi Holz



Code 633

Code 620, 622

Ø mm	    				
	U/min.   rpm   r.p.m.				
3	3800	2850	2500	2100	2300
4	2900	2150	1850	1600	1750
5	2350	1700	1500	1300	1400
6	1950	1450	1250	1100	1170
7	1650	1250	1100	900	1000
8	1450	1050	950	800	880
9	1300	950	850	700	780
10	1160	850	750	650	700
11	1050	780	680	580	650
12	970	700	620	530	580
14	830	600	530	450	500
16	730	550	470	400	440
18	650	480	420	350	400
20	580	430	370	320	350





Ø mm	    				
	U/min.   rpm   r.p.m.				
3	3000	2700	2300	1900	2300
4	2800	2000	1800	1400	1750
5	2200	1600	1400	1150	1400
6	1900	1300	1150	950	1170
8	1400	1000	900	700	880
10	1100	800	700	550	700
12	900	650	600	500	580



Holz







Code 616

Ø mm	U/min.   rpm   r.p.m.			
				
1	2700	2300	1900	1600
2	2700	2300	1900	1600
3	2700	2300	1900	1600
4	2000	1800	1400	1200
5	1600	1400	1100	1000
6	1300	1200	1000	800
7	1200	1000	800	700
8	1000	900	700	600
9	900	800	600	550
10	800	700	600	500
11	700	650	550	450
12	650	600	500	400
13	600	550	450	350
14	550	500	400	350
15	550	450	400	300
16	500	450	350	300
18	450	400	300	250
20	400	350	250	200

Schlangenbohrer / Auger bit / Broca salomónica "Form Lewis"



Code 216, 226, 228

Ø mm	U/min.   rpm   r.p.m.			
				
4	1000	800	800	800
5	1000	800	800	800
6	1000	800	800	800
8	1000	750	750	600
10	1000	600	600	450
12	1000	500	500	400
14	900	450	450	350
15	850	400	400	300
16	800	400	400	300
18	700	350	350	250
20	650	300	300	250
22	600	300	300	200
24	550	250	250	200
25	500	250	250	200
26	500	250	250	200
28	450	200	200	150
30	400	200	200	150
32	400	200	200	150



Holzbohrer  
wood drills  
brocas para madera

**D** Drehzahlen

**E** Spindle speeds

**ES** Velocidades

Die angegebenen Schnittwertempfehlungen beziehen sich auf Standardanwendungen.

The recommended cutting data refer to standard applications.

Las recomendaciones indicadas de los valores de corte se refieren a aplicaciones estándar.

**Forstnerbohrer / Forstner Bit / Broca fresadora para madera, „Sharp Shark“**

**Beschlagbohrer / Drill bits for cantilever hinges / Broca para herrajes**





Code 236, 239				
Ø mm				
	U/min.   rpm   r.p.m.			
10	2400	1800	1400	1100
12	2400	1500	1200	950
14	2150	1300	1050	850
15	2050	1200	950	800
16	1950	1150	900	750
18	1800	1050	850	650
20	1650	950	750	600
22	1550	850	700	550
24	1450	800	650	500
25	1400	750	600	500
26	1350	750	600	450
28	1300	700	550	450
30	1250	650	550	400
32	1200	600	500	400
35	1100	550	450	350
40	1000	500	400	300
45	900	450	350	300
50	850	400	300	250

Code 235				
Ø mm				
	U/min.   rpm   r.p.m.			
30	1400	800	650	550
35	1200	700	550	450

Schalungsbohrer / Cavity wood drills / Broca para encofrados







Code 055, 056, 065, 066, 075

Ø mm	U/min.   rpm   r.p.m.		
			
8	1400	1000	900
10	1100	800	700
12	900	650	600
14	800	600	500
16	700	500	450
18	600	450	400
20	550	400	350
22	500	350	300
24	450	350	300
26	400	300	300
28	400	300	250
30	350	250	250

Flachfräsbohrer / Flat wood bit / Broca fresadora plana



Code 237, 238, 234

Ø mm	U/min.   rpm   r.p.m.			
				
6	1700	1000	800	650
8	1450	900	700	550
10	1300	750	600	500
12	1150	700	550	450
13	1100	650	550	400
14	1050	650	500	400
16	1000	600	450	400
17	950	550	450	350
18	900	550	450	350
19	900	550	450	350
20	850	500	400	350
22	800	500	400	300
24	800	500	400	300
25	750	450	350	300
26	700	450	350	300
28	700	400	350	300
30	700	400	350	250
32	650	400	300	250
35	650	400	300	250
38	600	350	300	250
40	600	350	300	200



Holzbohrer  
wood drills  
brocas para madera



# HARTMETALL WERKZEUGE

// VOLLHARTMETALL-BOHRER, VOLLHARTMETALL-SENKER,  
HARTMETALL-FRÄSSTIFTE



### **E** TUNGSTEN CARBIDE TOOLS

- // SOLID CARBIDE DRILLS
- // SOLID CARBIDE COUNTERSINKS
- // TUNGSTEN CARBIDE ROTARY BURRS

### **ES** HERRAMIENTAS DE METAL DURO

- // BROCAS DE METAL DURO Y MACIZO
- // BROCAS AVELLADORAS DE METAL DURO Y MACIZO
- // PUNTAS DE AVELLANDO DE METAL DURO

Übersicht

Overview

Resumen

	DIN 6539		DIN 338	
				
Norm / Estándar	DIN 6539		DIN 338	
Name / Nombre	VHM Bohrer	VHM Bohrer	VHM Bohrer	VHM Bohrer
Typ / Type / Tipo	N	N	N	N
Bohrtiefe / Depth of drilling / Profundidad de perforación	3xD	3xD	5xD	5xD
Schneidstoff / Cutting material / Material de corte	VHM	VHM	VHM	VHM
Beschichtung / Coating / Recubrimiento		ALUNIT®		ALUNIT®
Spitzenwinkel / Lip angle / Ángulo de la punta	118°	118°	118°	118°
Schaft / Shank / Eje				
Ø mm	0,50 - 20,00	0,50 - 14,00	1,00 - 16,00	1,00 - 16,00
Code / Código	6146	6147	6156	6157
Seite / Page / Página	225	225	228	228
Geeignet für / Suitable for / Adecuada para				
 <b>Allgemeine Baustähle</b> Structural steels Aceros de construcción generales				
 <b>Automatenstähle</b> Free cutting steels Aceros de corte fácil				
 <b>Unlegierte Vergütungsstähle</b> Unalloyed heat treatable steels Aceros para bonifi car no aleados				
 <b>Legierte Vergütungsstähle</b> Alloyed heat treatable steels Aceros para bonifi car aleados				
 <b>Rostfreie Stähle</b> Stainless steels Aceros inoxidable				
 <b>Grauguss, Temperguss</b> Grey cast iron, malleable cast iron Hierro fundido gris, fundición maleable				
 <b>Titan- und Titanlegierungen</b> Titanium and titanium alloys Titanio y aleaciones de titanio				
 <b>Kupfer, Messing</b> Copper, brass Cobre, latón				
 <b>Aluminium</b> Aluminio Aluminio				
 <b>Kunststoffe</b> Plastics Plásticos				

Übersicht

Overview

Resumen

			
DIN 335		DIN 335	
VHM Senker	VHM Senker	VHM Senker	VHM Senker
VHM	VHM	VHM	VHM
	<b>ALUNIT®</b>		<b>ALUNIT®</b>
90°	90°	90°	90°
			
5,30 - 31,00	5,30 - 31,00	5,30 - 31,00	5,30 - 31,00
6530	6637	6405	6407
232	232	233	233
			
			
			
			
			
			
			
			
			
			



Hartmetall Werkzeuge  
 Tungsten carbide tools  
 herramientas de metal duro

Übersicht

Overview

Resumen











































						
Typ / Type / Tipo DIN	ZYA	ZYA-S	WRC	SPG	WKN	SKM
Typ / Type / Tipo ISO	A	A-S	C	G	N	M
Schneidstoff / Cutting material / Material de corte	Hartmetall	Hartmetall	Hartmetall	Hartmetall	Hartmetall	Hartmetall
Stirnverzahnung / Front cut / Dentado frontal	ja / yes / si					
Schaft / Shank / Eje						
Ø mm	2,00 - 20,00	2,00 - 20,00	3,00 - 20,00	3,00 - 16,00	3,00 - 12,00	3,00 - 16,00
Code / Código	7770 - 7778	7782 - 7789	7790 - 7799	7800 - 7809	7813 - 7816	7833 - 7837
Seite / Page / Página	234	236	238	240	242	244
Zahnung / Cut / Dentado						
 0	INOX					
 1A	Aluminium Aluminium Aluminio					
 2						
 3	DIN MY					
 4	Diamant Diamond Diamante					
 6	DIN MX					
 6 TiN	DIN MX					
 9	SPECIAL STEEL					



Übersicht

Overview

Resumen

						
KSK	KSJ	TRE	KUD	RBF	KEL	B
K	J	E	D	F	L	H
Hartmetall	Hartmetall	Hartmetall	Hartmetall	Hartmetall	Hartmetall	Hartmetall
						
3,00 - 20,00	3,00 - 16,00	3,00 - 16,00	2,50 - 20,00	3,00 - 20,00	3,00 - 16,00	6,00 - 16,00
7843, 7846	7853, 7856	7863, 7864, 7866	7873 - 7878	7880 - 7889	7890 - 7899	7903, 7904, 7906
246	248	250	252	254	256	258
						
						
						
						
						
						
						
						



Hartmetall Werkzeuge  
 Tungsten carbide tools  
 herramientas de metal duro



**MAYKESTAG** *INSIDE*



**Äußerst präzise und genau**

Der Mehrflächenanschliff bewirkt optimalen Spanbruch, hohe Zentriergenauigkeit und geringe Schnittkräfte

***Extremely precise and accurate***

*The multi faced point shapes results in optimum chip flow, high centering accuracy and low cutting forces*

***Especialmente precisa y exacta***

*El afilado para varias superficies logra una rotura de las virutas óptima, una elevada precisión del centrado y una menor fuerza de corte*

**Schnelle Bohrung**

Hohe Schnittgeschwindigkeit und Vorschübe

***Fast drilling***

*High cutting speeds and feeds*

***Perforación rápida***

*Velocidad de corte y avance elevados*

**Geeignet für schwer zerspanbare Materialien**

Selbst hochfester Stahl lässt sich exakt bohren

***Suitable for difficult-to-machine materials***

*Even heat resistant steel can be drilled precisely*

***Apto para materiales difícilmente mecanizables***

*Permite la perforación exacta incluso del acero más resistente*



**alpen** *drill better.*

**D** Vollhartmetall-Spiralbohrer, extra kurz, DIN 6539

**Einsatzbereich:**

Besonders geeignet zum Bohren von hochfesten Stählen, Cr-Ni-Stählen, Hartguss, Grauguss, Stahlguss, Mn-Hartstahl, Bronze, Aluminium mit hohem Siliziumanteil und anderen schwer zerspanbaren Werkstoffen (beschichtete Ausführung).

**E** Solid carbide stub drills, short series, DIN 6539

**Range of application:**

Especially suitable for drilling heat resistant steels, Cr-Ni steels, high carbon steel castings, grey cast iron, cast steels, manganese steels, bronze, aluminium with high percentage silicon and other difficult-to-machine materials (coated design).

**ES** Broca espiral de metal duro y macizo, extra corta, DIN 6539

**Ámbito de aplicación:**

Especialmente adecuada para el taladrado de aceros de alta resistencia, aceros al cromo-níquel, fundición blanca, hierro fundido gris, fundición de acero, acero duro con manganeso, bronce, aluminio con contenido elevado de silicio y otros materiales difícilmente mecanizables con virutaje (diseño recubierto).



Einzelverpackung  
Single packing  
Embalaje individual



**ALUNIT®**  
Höhere Performance, längere Standzeit  
Higher performance, longer durability  
Rendimiento superior tiempo de uso más prolongado

Einzelverpackung  
Single packing  
Embalaje individual

d1 mm	l1 mm	l2 mm	blank / bright / brillante		ALUNIT®	
			Code 6146 Art.-Nr.	Inh. Cont.	Code 6147 Art.-Nr.	Inh. Cont.
0,50	26	6	0614600050100	1	0614700050100	1
0,60	26	6	0614600060100	1	0614700060100	1
0,70	26	6	0614600070100	1	0614700070100	1
0,80	26	6	0614600080100	1	0614700080100	1
0,90	26	6	0614600090100	1	0614700090100	1
1,00	26	6	0614600100100	1	0614700100100	1
1,10	28	7	0614600110100	1	0614700110100	1
1,20	30	8	0614600120100	1	0614700120100	1
1,30	30	8	0614600130100	1	0614700130100	1
1,40	32	9	0614600140100	1	0614700140100	1
1,50	32	9	0614600150100	1	0614700150100	1
1,60	34	10	0614600160100	1	0614700160100	1
1,70	34	10	0614600170100	1	0614700170100	1
1,80	36	11	0614600180100	1	0614700180100	1
1,90	36	11	0614600190100	1	0614700190100	1
2,00	38	12	0614600200100	1	0614700200100	1
2,10	38	12	0614600210100	1	0614700210100	1
2,20	40	13	0614600220100	1	0614700220100	1
2,30	40	13	0614600230100	1	0614700230100	1
2,40	43	14	0614600240100	1	0614700240100	1
2,50	43	14	0614600250100	1	0614700250100	1
2,60	43	14	0614600260100	1	0614700260100	1



Hartmetall Werkzeuge  
Tungsten carbide tools  
herramientas de metal duro

			Einzelverpackung <i>Single packing</i> <i>Embalaje individual</i>		Einzelverpackung <i>Single packing</i> <i>Embalaje individual</i>	
			blank / bright / brillante		ALUNIT®	
d1 mm	l1 mm	l2 mm	Code 6146 Art.-Nr.	Inh. Cont.	Code 6147 Art.-Nr.	Inh. Cont.
2,70	46	16	0614600270100	1	0614700270100	1
2,80	46	16	0614600280100	1	0614700280100	1
2,90	46	16	0614600290100	1	0614700290100	1
3,00	46	16	0614600300100	1	0614700300100	1
3,10	49	18	0614600310100	1	0614700310100	1
3,20	49	18	0614600320100	1	0614700320100	1
3,30	49	18	0614600330100	1	0614700330100	1
3,40	52	20	0614600340100	1	0614700340100	1
3,50	52	20	0614600350100	1	0614700350100	1
3,60	52	20	0614600360100	1	0614700360100	1
3,70	52	20	0614600370100	1	0614700370100	1
3,80	55	22	0614600380100	1	0614700380100	1
3,90	55	22	0614600390100	1	0614700390100	1
4,00	55	22	0614600400100	1	0614700400100	1
4,10	55	22	0614600410100	1	0614700410100	1
4,20	55	22	0614600420100	1	0614700420100	1
4,30	58	24	0614600430100	1	0614700430100	1
4,40	58	24	0614600440100	1	0614700440100	1
4,50	58	24	0614600450100	1	0614700450100	1
4,60	58	24	0614600460100	1	0614700460100	1
4,70	58	24	0614600470100	1	0614700470100	1
4,80	62	26	0614600480100	1	0614700480100	1
4,90	62	26	0614600490100	1	0614700490100	1
5,00	62	26	0614600500100	1	0614700500100	1
5,10	62	26	0614600510100	1	0614700510100	1
5,20	62	26	0614600520100	1	0614700520100	1
5,30	62	26	0614600530100	1	0614700530100	1
5,40	66	28	0614600540100	1	0614700540100	1
5,50	66	28	0614600550100	1	0614700550100	1
5,60	66	28	0614600560100	1	0614700560100	1
5,70	66	28	0614600570100	1	0614700570100	1
5,80	66	28	0614600580100	1	0614700580100	1
5,90	66	28	0614600590100	1	0614700590100	1
6,00	66	28	0614600600100	1	0614700600100	1
6,10	70	31	0614600610100	1	0614700610100	1
6,20	70	31	0614600620100	1	0614700620100	1
6,30	70	31	0614600630100	1	0614700630100	1
6,40	70	31	0614600640100	1	0614700640100	1
6,50	70	31	0614600650100	1	0614700650100	1
6,60	70	31	0614600660100	1	0614700660100	1
6,70	70	31	0614600670100	1	0614700670100	1
6,80	74	34	0614600680100	1	0614700680100	1
6,90	74	34	0614600690100	1	0614700690100	1
7,00	74	34	0614600700100	1	0614700700100	1
7,10	74	34	0614600710100	1	0614700710100	1
7,20	74	34	0614600720100	1	0614700720100	1
7,30	74	34	0614600730100	1	0614700730100	1
7,40	74	34	0614600740100	1	0614700740100	1
7,50	74	34	0614600750100	1	0614700750100	1
7,60	79	36	0614600760100	1	0614700760100	1
7,70	79	36	0614600770100	1	0614700770100	1
7,80	79	36	0614600780100	1	0614700780100	1
7,90	79	36	0614600790100	1	0614700790100	1
8,00	79	37	0614600800100	1	0614700800100	1
8,10	79	36	0614600810100	1	0614700810100	1
8,20	79	36	0614600820100	1	0614700820100	1

			Einzelverpackung <i>Single packing</i> <i>Embalaje individual</i>		Einzelverpackung <i>Single packing</i> <i>Embalaje individual</i>	
			blank / bright / brillante		ALUNIT®	
d1 mm	l1 mm	l2 mm	Code 6146 Art.-Nr.	Inh. Cont.	Code 6147 Art.-Nr.	Inh. Cont.
8,30	79	36	0614600830100	1	0614700830100	1
8,40	79	36	0614600840100	1	0614700840100	1
8,50	79	37	0614600850100	1	0614700850100	1
8,60	84	40	0614600860100	1	0614700860100	1
8,70	84	40	0614600870100	1	0614700870100	1
8,80	84	40	0614600880100	1	0614700880100	1
8,90	84	40	0614600890100	1	0614700890100	1
9,00	84	40	0614600900100	1	0614700900100	1
9,10	84	40	0614600910100	1	0614700910100	1
9,20	84	40	0614600920100	1	0614700920100	1
9,30	84	40	0614600930100	1	0614700930100	1
9,40	84	40	0614600940100	1	0614700940100	1
9,50	84	40	0614600950100	1	0614700950100	1
9,60	89	43	0614600960100	1	0614700960100	1
9,70	89	43	0614600970100	1	0614700970100	1
9,80	89	43	0614600980100	1	0614700980100	1
9,90	89	43	0614600990100	1	0614700990100	1
10,00	89	43	0614601000100	1	0614701000100	1
10,20	89	43	0614601020100	1	0614701020100	1
10,50	89	43	0614601050100	1	0614701050100	1
10,80	95	47	0614601080100	1	0614701080100	1
11,00	95	47	0614601100100	1	0614701100100	1
11,50	95	47	0614601150100	1	0614701150100	1
12,00	102	51	0614601200100	1	0614701200100	1
12,50	102	51	0614601250100	1	0614701250100	1
13,00	102	51	0614601300100	1	0614701300100	1
13,50	107	54	0614601350100	1	0614701350100	1
14,00	107	54	0614601400100	1	0614701400100	1
14,50	111	56	0614601450100	1		
15,00	111	56	0614601500100	1		
15,50	115	58	0614601550100	1		
16,00	115	58	0614601600100	1		
16,50	119	60	0614601650100	1		
17,00	119	60	0614601700100	1		
17,50	123	62	0614601750100	1		
18,00	123	62	0614601800100	1		
18,50	127	64	0614601850100	1		
19,00	127	64	0614601900100	1		
19,50	131	66	0614601950100	1		
20,00	131	66	0614602000100	1		



Hartmetall Werkzeuge  
Tungsten carbide tools  
herramientas de metal duro

≤ Ø 2,90 mm 4-Flächenanschliff / ≥ Ø 3,00 mm 6-Flächenanschliff  
 ≤ Ø 2,90 mm 4-faced point shape / ≥ Ø 3,00 mm 6-faced point shape  
 ≤ Ø 2,90 mm 4-Punta afi lada cuádruple / ≥ Ø 3,00 mm 6-Punta afi lada cuádruple

**① Vollhartmetall-Spiralbohrer, lang, DIN 338**

**Einsatzbereich:**

Besonders geeignet zum Bohren von hochfesten Stählen, Cr-Ni-Stählen, Hartguss, Grauguss, Stahlguss, Mn-Hartstahl, Bronze, Aluminium mit hohem Siliziumanteil und anderen schwer zerspanbaren Werkstoffen (beschichtete Ausführung).

**② Solid carbide jobber drills, long series, DIN 338**

**Range of application:**

Especially suitable for drilling heat resistant steels, Cr-Ni steels, high carbon steel castings, grey cast iron, cast steels, manganese steels, bronze, aluminium with high percentage silicon and other difficult-to-machine materials (coated design).

**③ Broca espiral de metal duro y macizo, larga, DIN 338**

**Ámbito de aplicación:**

Especialmente adecuada para el taladrado de aceros de alta resistencia, aceros al cromo-níquel, fundición blanca, hierro fundido gris, fundición de acero, acero duro con manganeso, bronce, aluminio con contenido elevado de silicio y otros materiales difícilmente mecanizables con virutaje (diseño recubierto).

				Einzelverpackung Single packing Embalaje individual		Einzelverpackung Single packing Embalaje individual	
				blank / bright / brillante		ALUNIT®	
d1 mm	l1 mm	l2 mm	d2 mm	Code 6156 Art.-Nr.	Inh. Cont.	Code 6157 Art.-Nr.	Inh. Cont.
1,00	34	12		0615600100100	1	0615700100100	1
1,10	36	14		0615600110100	1	0615700110100	1
1,20	38	16		0615600120100	1	0615700120100	1
1,30	38	16		0615600130100	1	0615700130100	1
1,40	40	18		0615600140100	1	0615700140100	1
1,50	40	18		0615600150100	1	0615700150100	1
1,60	43	20		0615600160100	1	0615700160100	1
1,70	43	20		0615600170100	1	0615700170100	1
1,80	46	22		0615600180100	1	0615700180100	1
1,90	46	22		0615600190100	1	0615700190100	1
2,00	49	24		0615600200100	1	0615700200100	1
2,10	49	24		0615600210100	1	0615700210100	1
2,20	53	27		0615600220100	1	0615700220100	1
2,30	53	27		0615600230100	1	0615700230100	1
2,40	57	30		0615600240100	1	0615700240100	1
2,50	57	30		0615600250100	1	0615700250100	1
2,60	57	30		0615600260100	1	0615700260100	1
2,70	61	33		0615600270100	1	0615700270100	1
2,80	61	33		0615600280100	1	0615700280100	1
2,90	61	33		0615600290100	1	0615700290100	1
3,00	61	33		0615600300100	1	0615700300100	1
3,10	65	36		0615600310100	1	0615700310100	1

				Einzelverpackung <i>Single packing</i> <i>Embalaje individual</i>		Einzelverpackung <i>Single packing</i> <i>Embalaje individual</i>	
				blank / bright / brillante		ALUNIT®	
d1 mm	l1 mm	l2 mm	d2 mm	Code 6156 Art.-Nr.	Inh. Cont.	Code 6157 Art.-Nr.	Inh. Cont.
3,20	65	36		0615600320100	1	0615700320100	1
3,30	65	36		0615600330100	1	0615700330100	1
3,40	70	39		0615600340100	1	0615700340100	1
3,50	70	39		0615600350100	1	0615700350100	1
3,60	70	39		0615600360100	1	0615700360100	1
3,70	70	39		0615600370100	1	0615700370100	1
3,80	75	43		0615600380100	1	0615700380100	1
3,90	75	43		0615600390100	1	0615700390100	1
4,00	75	43		0615600400100	1	0615700400100	1
4,10	75	43		0615600410100	1	0615700410100	1
4,20	75	43		0615600420100	1	0615700420100	1
4,30	80	47		0615600430100	1	0615700430100	1
4,40	80	47		0615600440100	1	0615700440100	1
4,50	80	47		0615600450100	1	0615700450100	1
4,60	80	47		0615600460100	1	0615700460100	1
4,70	80	47		0615600470100	1	0615700470100	1
4,80	86	52		0615600480100	1	0615700480100	1
4,90	86	52		0615600490100	1	0615700490100	1
5,00	86	52		0615600500100	1	0615700500100	1
5,10	86	52		0615600510100	1	0615700510100	1
5,20	86	52		0615600520100	1	0615700520100	1
5,30	86	52		0615600530100	1	0615700530100	1
5,40	93	57		0615600540100	1	0615700540100	1
5,50	93	57		0615600550100	1	0615700550100	1
5,60	93	57		0615600560100	1	0615700560100	1
5,70	93	57		0615600570100	1	0615700570100	1
5,80	93	57		0615600580100	1	0615700580100	1
5,90	93	57		0615600590100	1	0615700590100	1
6,00	93	57		0615600600100	1	0615700600100	1
6,10	101	63		0615600610100	1	0615700610100	1
6,20	101	63		0615600620100	1	0615700620100	1
6,30	101	63		0615600630100	1	0615700630100	1
6,40	101	63		0615600640100	1	0615700640100	1
6,50	101	63		0615600650100	1	0615700650100	1
6,60	101	63		0615600660100	1	0615700660100	1
6,70	101	63		0615600670100	1	0615700670100	1
6,80	109	69		0615600680100	1	0615700680100	1
6,90	109	69		0615600690100	1	0615700690100	1
7,00	109	69		0615600700100	1	0615700700100	1
7,10	109	69		0615600710100	1	0615700710100	1
7,20	109	69		0615600720100	1	0615700720100	1
7,30	109	69		0615600730100	1	0615700730100	1
7,40	109	69		0615600740100	1	0615700740100	1
7,50	109	69		0615600750100	1	0615700750100	1
7,60	117	75		0615600760100	1	0615700760100	1
7,70	117	75		0615600770100	1	0615700770100	1
7,80	117	75		0615600780100	1	0615700780100	1
7,90	117	75		0615600790100	1	0615700790100	1
8,00	117	75		0615600800100	1	0615700800100	1
8,10	117	75		0615600810100	1	0615700810100	1
8,20	117	75		0615600820100	1	0615700820100	1
8,30	117	75		0615600830100	1	0615700830100	1
8,40	117	75		0615600840100	1	0615700840100	1
8,50	117	75		0615600850100	1	0615700850100	1
8,60	125	81		0615600860100	1	0615700860100	1
8,70	125	81		0615600870100	1	0615700870100	1



Hartmetall Werkzeuge  
Tungsten carbide tools  
herramientas de metal duro

				Einzelverpackung <i>Single packing</i> <i>Embalaje individual</i>		Einzelverpackung <i>Single packing</i> <i>Embalaje individual</i>	
				blank / bright / brillante		ALUNIT®	
d1 mm	l1 mm	l2 mm	d2 mm	Code 6156 Art.-Nr.	Inh. Cont.	Code 6157 Art.-Nr.	Inh. Cont.
8,80	125	81		0615600880100	1	0615700880100	1
8,90	125	81		0615600890100	1	0615700890100	1
9,00	125	81		0615600900100	1	0615700900100	1
9,10	125	81		0615600910100	1	0615700910100	1
9,20	125	81		0615600920100	1	0615700920100	1
9,30	125	81		0615600930100	1	0615700930100	1
9,40	125	81		0615600940100	1	0615700940100	1
9,50	125	81		0615600950100	1	0615700950100	1
9,60	133	87		0615600960100	1	0615700960100	1
9,70	133	87		0615600970100	1	0615700970100	1
9,80	133	87		0615600980100	1	0615700980100	1
9,90	133	87		0615600990100	1	0615700990100	1
10,00	133	87		0615601000100	1	0615701000100	1
10,20	133	87		0615601020100	1	0615701020100	1
10,50	133	87		0615601050100	1	0615701050100	1
10,80	142	94		0615601080100	1	0615701080100	1
11,00	142	94		0615601100100	1	0615701100100	1
11,50	142	94		0615601150100	1	0615701150100	1
12,00	151	101		0615601200100	1	0615701200100	1
12,50	151	101		0615601250100	1	0615701250100	1
13,00	151	101		0615601300100	1	0615701300100	1
13,50	160	108		0615601350100	1	0615701350100	1
14,00	160	108		0615601400100	1	0615701400100	1
14,50	169	114		0615601450100	1	0615701450100	1
15,00	169	114		0615601500100	1	0615701500100	1
15,50	178	120		0615601550100	1	0615701550100	1
16,00	178	120		0615601600100	1	0615701600100	1

≤ Ø 2,90 mm 4-Flächenanschliff / ≥ Ø 3,00 mm 6-Flächenanschliff  
 ≤ Ø 2,90 mm 4-faced point shape / ≥ Ø 3,00 mm 6-faced point shape  
 ≤ Ø 2,90 mm 4-Punta afi lada cuádruple / ≥ Ø 3,00 mm 6-Punta afi lada cuádruple





**MAYKESTAG** INSIDE



**Perfekte Ergebnisse**

Beste Ergebnisse garantiert durch die ungleich geteilten Schneiden und den optimalen Hinterschliff

**Perfect results**

Best results guaranteed by the unequally divided cutting edges and the optimal relief

**Resultados perfectos**

Los mejores resultados garantizados gracias a los filos de cortes desiguales y al talón óptimo

**Ruhiger Lauf**

Rattermarken werden vermieden

**Smooth running**

Avoiding chatter marks

**Funcionamiento silencioso**

Evita el rayado transversal

**Leicht nachschärfbar**

Aufgrund des radialen Hinterschliffs

**Easy to re-sharpen**

Due to the radial back taper

**Reafilado sencillo**

gracias al talón radial

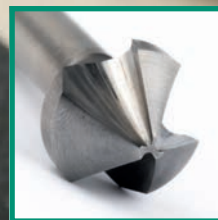

**alpen** *drill better.*

**1** Vollhartmetall-Kegelsenker  
ungleiche Teilung  
DIN 335 C, 90°

**Einsatzbereich:**

Für alle E- und NE-Metalle, Kunststoffe hart und weich. Universell einsetzbares Entgrat- und Senkwerkzeug für Bohrungen aller Art. Sehr gute Schneideigenschaften durch ungleichgeteilte Schneiden. Verringerung der Vorschubkraft und Ratterbildung an der Senkoberfläche durch reduzierte Axial- und Radialkraft.

**E** Solid carbide countersinks  
different partition  
DIN 335 C, 90°

**Range of application:**

For ferrous and non-ferrous metals, synthetic materials soft and hard. Universal deburring and sink tool for all kind of borings. Excellent cutting features guarantee a smooth surface by unequally divided cutting edges. Reduction of feed force and chatter marks on the countersinking surface due to reduced axial and radial force.

**ES** Avellanador cónico de metal  
duro y macizo división irregular  
DIN 335 C, 90°

**Ámbito de aplicación:**

Para todos los metales E y NE y plásticos duros y blandos. Herramienta para desbarbar y avellanar de aplicación universal para agujeros de todo tipo. Excelentes características de corte, por corte desigual dividida. Reducción del avance y de vibración en la superficie avellanada gracias a las fuerzas axiales y radiales reducidas.

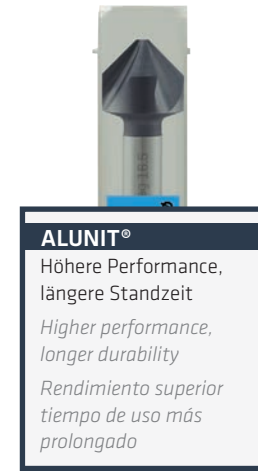
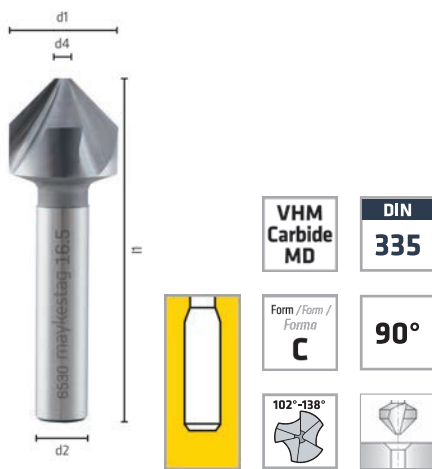

Einzelverpackung  
Single packing  
Embalaje individual

Einzelverpackung  
Single packing  
Embalaje individual

					blank / bright / brillante	ALUNIT®		
d1	d4	d2 <sub>hs</sub>	l1	Z	Code 6530	Inh.	Code 6637	Inh.
mm	mm	mm	mm		Art.-Nr.	Cont.	Art.-Nr.	Cont.
5,30	1,00	4,00	40	3	0653000530100	1	0663700530100	1
6,30	1,50	5,00	45	3	0653000630100	1	0663700630100	1
8,30	2,00	6,00	50	3	0653000830100	1	0663700830100	1
10,40	2,50	6,00	50	3	0653001040100	1	0663701040100	1
12,40	2,80	8,00	56	3	0653001240100	1	0663701240100	1
14,40	2,90	8,00	56	3	0653001440100	1	0663701440100	1
16,50	3,20	10,00	60	3	0653001650100	1	0663701650100	1
19,50	3,50	10,00	63	3	0653001950100	1	0663701950100	1
20,50	3,50	10,00	63	3	0653002050100	1	0663702050100	1
25,00	3,80	10,00	67	3	0653002500100	1	0663702500100	1
31,00	4,20	12,00	71	3	0653003100100	1	0663703100100	1

Ø 5,30 VHM / solid carbide / metal duro y macizo

Ø 6,30–31,00 nur VHM-Kopf / only solid carbide cutting part / solo cabezal de metal duro y macizo

**D** Vollhartmetall-Kegelsenker  
DIN 335 C, 90°

**Einsatzbereich:**

Zum ratterfreien Senken und Entgraten von Stählen, hochfesten Stählen, Grauguss, VA-Werkstoffen sowie siliziumhaltigen Aluminium-Legierungen.

**E** Solid carbide countersinks  
DIN 335 C, 90°

**Range of application:**

For countersinking and deburring of steels with medium/high tensile strength, cast iron, stainless steels as well as silicium containing aluminium alloys.

**ES** Avellanador cónico de metal duro y macizo  
DIN 335 C, 90°

**Ámbito de aplicación:**

Para el avellanado y el desbarbado sin vibraciones de aceros, aceros de alta resistencia, hierro fundido gris, materiales VA, así como aleaciones de aluminio con contenido de silicio.

					<p>Einzelverpackung Single packing Embalaje individual</p>		<p>Einzelverpackung Single packing Embalaje individual</p>	
					<p>blank / bright / brillante</p>		<p>ALUNIT®</p>	
d1 mm	d4 mm	d2 <sub>h9</sub> mm	l1 mm	Z	Code 6405 Art.-Nr.	Inh. Cont.	Code 6407 Art.-Nr.	Inh. Cont.
5,30	1,00	6,00	45	3	0640500530100	1	0640700530100	1
6,30	1,50	6,00	45	3	0640500630100	1	0640700630100	1
8,30	2,00	6,00	50	3	0640500830100	1	0640700830100	1
10,40	2,50	8,00	50	3	0640501040100	1	0640701040100	1
12,40	2,80	8,00	56	3	0640501240100	1	0640701240100	1
14,40	3,00	8,00	56	3	0640501440100	1	0640701440100	1
16,50	3,20	10,00	60	3	0640501650100	1	0640701650100	1
19,50	3,50	10,00	63	3	0640501950100	1	0640701950100	1
20,50	3,50	10,00	63	3	0640502050100	1	0640702050100	1
25,00	3,80	10,00	67	3	0640502500100	1	0640702500100	1
31,00	4,20	12,00	71	3	0640503100100	1	0640703100100	1



Hartmetall Werkzeuge  
Tungsten carbide tools  
herramientas de metal duro

Ø 5,30 VHM / solid carbide / metal duro y macizo  
Ø 6,30–31,00 nur VHM-Kopf / only solid carbide cutting part / solo cabezal de metal duro y macizo

① Hartmetall-Frässtifte, Zylinder, ohne Stirnverzahnung

② Tungsten carbide rotary burrs, cylindrical, without front cut

③ Puntas de avellanado de metal duro, cilíndricas, sin dentado frontal



INOX



Diamant  
Diamond  
Diamante



Aluminium  
Aluminium  
Aluminio

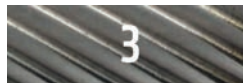

DIN MY

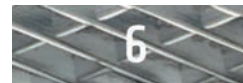

DIN MX



DIN  
**ZYA**  
ISO  
**A**

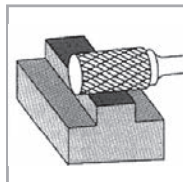

**INOX**  
Herausragende Fräseleistung bei Edelstahl/Niro  
*Outstanding milling performance in stainless steel*  
*Rendimiento de fresado excelente en acero inoxidable/ acero niro*

Einzelverpackung  
Single packing  
Embalaje individual



\* Einzelverpackung mit SB  
Single packaging with tag  
Embalaje individual con gancho para autoservicio



				0	1A	2	3
d1	d2	l1	l2	Code 7770 Art.-Nr.	Code 7778 Art.-Nr.		Code 7773 Art.-Nr.
mm	mm	mm	mm				
2,00	3,00	38	10				0777303102100
3,00	3,00	38	10				0777303103100
3,00	3,00	50	14				0777303303100
3,00	3,00	65	14				0777303104100
4,00	3,00	40	10				0777303106100
4,00	6,00	50	14				0777306106100
6,00	3,00	43	13				0777306108100
6,00	6,00	50	16	0777006106100	0777806106100		0777306110100
8,00	6,00	65	20	0777006108100			0777306112100
10,00	6,00	58	13				0777306116100
10,00	6,00	65	20	0777006110100	0777806110100		0777306120100
12,00	6,00	70	25	0777006112100	0777806112100		
12,00	8,00	70	25				
16,00	6,00	70	25				
20,00	6,00	70	25				





6 TiN

DIN MX



9

SPECIAL STEEL

Nähere Informationen zu den einzelnen Zahnungen siehe Seite 261.

*Detailed information about the different cuts see on page 261.*

*Consulte en la página 261 información más detallada sobre todos los dentados.*

**SPECIAL STEEL**

Aggressive Geometrie -  
hoher Materialabtrag

*Aggressive geometry -  
high chip removal*

*Geometría agresiva  
- alta remoción de  
material*

d1 mm	d2 mm	l1 mm	l2 mm																
				Code 7774 Art.-Nr.				Code 7776 Art.-Nr.				Code 7777 Art.-Nr.							
2,00	3,00	38	10					0777603102100											
3,00	3,00	38	10	0777403103100				0777603103100				0777703103100							
3,00	3,00	50	14					0777603203100											
3,00	3,00	65	14					0777603303100											
4,00	3,00	40	10					0777603104100											
4,00	6,00	50	14	0777406104100				0777606104100											
6,00	3,00	43	13	0777403106100				0777603106100											
6,00	6,00	50	16	0777406106100				0777606106100 *				0777706106100							
8,00	6,00	65	20	0777406108100				0777606108100				0777706108100							
10,00	6,00	58	13					0777606310100											
10,00	6,00	65	20	0777406110100				0777606110100 *				0777706110100							
12,00	6,00	70	25	0777406112100				0777606112100 *				0777706112100							
12,00	8,00	70	25					0777608112100											
16,00	6,00	70	25	0777406116100				0777606116100											
20,00	6,00	70	25																



Hartmetall Werkzeuge  
Tungsten carbide tools  
herramientas de metal duro



① Hartmetall-Frässtifte, Zylinder, mit Stirnverzahnung

② Tungsten carbide rotary burrs, cylindrical, with front cut

③ Puntas de avellanado de metal duro, cilíndricas, con dentado frontal



INOX



Diamant  
Diamond  
Diamante



Aluminium  
Aluminium  
Aluminio



DIN MY



DIN MX



DIN  
ZYA-S

ISO  
A-S

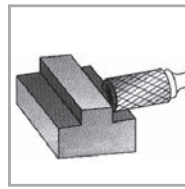

**INOX**  
Herausragende Fräseleistung bei Edelstahl/Niro  
*Outstanding milling performance in stainless steel*  
*Rendimiento de fresado excelente en acero inoxidable/ acero niro*

Einzelverpackung  
Single packing  
Embalaje individual



\* Einzelverpackung mit SB  
Single packaging with tag  
Embalaje individual con gancho para autoservicio



d1 mm	d2 mm	l1 mm	l2 mm	0	1A	2	3
				Code 7788 Art.-Nr.	Code 7782 Art.-Nr.	Code 7783 Art.-Nr.	
2,00	3,00	38	10				0778303102100
2,00	3,00	50	10				0778303103100
3,00	3,00	38	14				0778303203100
3,00	3,00	50	14				0778303403100
3,00	3,00	75	14				0778306104100
4,00	6,00	50	14				0778303106100
6,00	3,00	43	13				0778306106100
6,00	6,00	50	16			0778206106100	0778306106100
8,00	6,00	65	20			0778206108100	0778306108100
10,00	6,00	58	13				0778306110100
10,00	6,00	65	20		0778806110100	0778206110100	0778306110100
12,00	6,00	70	25		0778806112100 *	0778206112100	0778306112100
16,00	6,00	70	25				0778306116100
20,00	8,00	70	25				





6 TiN

DIN MX



9

SPECIAL STEEL

Nähere Informationen zu den einzelnen Zahnungen siehe Seite 261.

*Detailed information about the different cuts see on page 261.*

*Consulte en la página 261 información más detallada sobre todos los dentados.*

**SPECIAL STEEL**

Aggressive Geometrie - hoher Materialabtrag

*Aggressive geometry - high chip removal*

*Geometría agresiva - alta remoción de material*

							
d1 mm	d2 mm	l1 mm	l2 mm	Code 7784 Art.-Nr.	Code 7786 Art.-Nr.	Code 7787 Art.-Nr.	Code 7789 Art.-Nr.
2,00	3,00	38	10				
2,00	3,00	50	10	0778403202100			
3,00	3,00	38	14	0778403103100	0778603103100	0778703103100	
3,00	3,00	50	14	0778403203100	0778603203100		
3,00	3,00	75	14	0778403403100			
4,00	6,00	50	14	0778406104100	0778606104100		
6,00	3,00	43	13	0778403106100	0778603106100		
6,00	6,00	50	16	0778406106100	0778606106100 *	0778706106100	0778906106100
8,00	6,00	65	20	0778406108100	0778606108100	0778706108100	0778906108100
10,00	6,00	58	13		0778606210100		
10,00	6,00	65	20	0778406110100	0778606110100 *	0778706110100	0778906110100
12,00	6,00	70	25		0778606112100 *	0778706112100	0778906112100
16,00	6,00	70	25	0778406116100	0778606116100		
20,00	8,00	70	25	0778408120100			



Hartmetall Werkzeuge  
 Tungsten carbide tools  
 herramientas de metal duro



① Hartmetall-Frässtifte, Walzenrund

② Tungsten carbide rotary burrs, ball nose

③ Puntas de avellanado de metal duro esferocilíndricas



INOX



Diamant  
Diamond  
Diamante



Aluminium  
Aluminium  
Aluminio

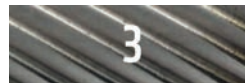

DIN MY



DIN MX

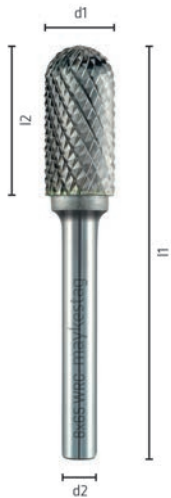

DIN  
WRC

ISO  
C

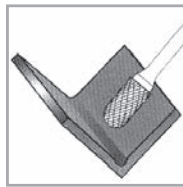

**INOX**

Herausragende Fräseleistung bei Edelstahl/Niro

Outstanding milling performance in stainless steel

Rendimiento de fresado excelente en acero inoxidable/ acero niro

Einzelverpackung  
Single packing  
Embalaje individual



\* Einzelverpackung mit SB  
Single packaging with tag  
Embalaje individual con gancho para autoservicio



				0	1A	2	3
d1 mm	d2 mm	l1 mm	l2 mm	Code 7790 Art.-Nr.	Code 7798 Art.-Nr.	Code 7792 Art.-Nr.	Code 7793 Art.-Nr.
3,00	3,00	38	14				0779303103100
3,00	3,00	50	14				0779303203100
4,00	3,00	40	10				0779303104100
4,00	6,00	50	14				0779306104100
5,00	3,00	42	12				
6,00	3,00	43	14				0779303106100
6,00	6,00	50	14	0779006106100		0779206106100	0779306106100
6,00	6,00	150	16				0779306206100
8,00	6,00	65	20	0779006108100	0779806108100	0779206108100	0779306108100
10,00	6,00	65	20	0779006110100	0779806110100	0779206110100	0779306110100
10,00	6,00	70	25				
10,00	6,00	150	20				
12,00	6,00	70	25	0779006112100	0779806112100	0779206112100	0779306112100
12,00	6,00	150	25				
12,00	8,00	70	25				
16,00	6,00	70	25				0779306116100
20,00	6,00	70	25				







DIN MX



SPECIAL STEEL

Nähere Informationen zu den einzelnen Zahnungen siehe Seite 261.

*Detailed information about the different cuts see on page 261.*





*Consulte en la página 261 información más detallada sobre todos los dentados.*

**SPECIAL STEEL**

Aggressive Geometrie - hoher Materialabtrag

*Aggressive geometry - high chip removal*

*Geometría agresiva - alta remoción de material*

d1 mm	d2 mm	l1 mm	l2 mm	   			
				Code 7794 Art.-Nr.	Code 7796 Art.-Nr.	Code 7797 Art.-Nr.	Code 7799 Art.-Nr.
3,00	3,00	38	14	0779403103100	0779603103100	0779703103100	
3,00	3,00	50	14		0779603203100		
4,00	3,00	40	10	0779403104100	0779603104100		
4,00	6,00	50	14		0779606104100		
5,00	3,00	42	12	0779403105100			
6,00	3,00	43	14	0779403106100	0779603106100		
6,00	6,00	50	14	0779406106100		0779706106100	0779906106100
6,00	6,00	150	16	0779406206100	0779606206100		
8,00	6,00	65	20	0779406108100	0779606108100	0779706108100	0779906108100
10,00	6,00	65	20	0779406110100	0779606110100 *	0779706110100	0779906110100
10,00	6,00	70	25		0779606310100		
10,00	6,00	150	20	0779406210100			
12,00	6,00	70	25	0779406112100	0779606112100 *	0779706112100	0779906112100
12,00	6,00	150	25	0779406212100			
12,00	8,00	70	25		0779608112100		
16,00	6,00	70	25	0779406116100	0779606116100		
20,00	6,00	70	25	0779406120100			



Hartmetall Werkzeuge  
 Tungsten carbide tools  
 herramientas de metal duro



① Hartmetall-Frässtifte, Spitzbogen

② Tungsten carbide rotary burrs, arc pointed nose

③ Puntas de avellanado de metal duro, angulares ojivales



INOX



Diamant  
Diamond  
Diamante



Aluminium  
Aluminium  
Aluminio

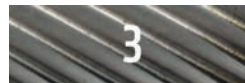

DIN MY

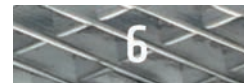

DIN MX



DIN  
SPG

ISO  
G

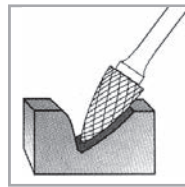

**INOX**

Herausragende Fräseleistung bei Edelstahl/Niro  
*Outstanding milling performance in stainless steel*  
*Rendimiento de fresado excelente en acero inoxidable/ acero niro*

Einzelverpackung  
Single packing  
Embalaje individual

\* Einzelverpackung mit SB  
Single packaging with tag  
Embalaje individual con gancho para autoservicio



				0	1A	2	3
d1	d2	l1	l2	Code 7800 Art.-Nr.	Code 7808 Art.-Nr.		Code 7803 Art.-Nr.
mm	mm	mm	mm				
3,00	3,00	38	12				0780303103100
4,00	3,00	40	10				0780303104100
4,00	6,00	50	14				
6,00	3,00	43	13				0780303106100
6,00	6,00	50	16	0780006106100			0780306106100
8,00	6,00	65	20	0780006108100			0780306108100
10,00	6,00	65	20	0780006110100	0780806110100		0780306110100
12,00	6,00	70	25	0780006112100	0780806112100		0780306112100
12,00	6,00	75	25				
12,00	8,00	70	25				
16,00	6,00	75	30				0780306116100
16,00	8,00	75	30				

NEW





DIN MX



SPECIAL STEEL

Nähere Informationen zu den einzelnen Zahnungen siehe Seite 261.

*Detailed information about the different cuts see on page 261.*



*Consulte en la página 261 información más detallada sobre todos los dentados.*

**SPECIAL STEEL**

Aggressive Geometrie - hoher Materialabtrag

*Aggressive geometry - high chip removal*

*Geometría agresiva - alta remoción de material*

d1 mm	d2 mm	l1 mm	l2 mm				
				Code 7804 Art.-Nr.	Code 7806 Art.-Nr.	Code 7807 Art.-Nr.	Code 7809 Art.-Nr.
3,00	3,00	38	12	0780403103100	0780603103100	0780703103100	
4,00	3,00	40	10				
4,00	6,00	50	14		0780606104100		
6,00	3,00	43	13	0780403106100			
6,00	6,00	50	16	0780406106100	0780606106100 *	0780706106100	0780906106100
8,00	6,00	65	20	0780406108100	0780606108100		0780906108100
10,00	6,00	65	20	0780406110100	0780606110100	0780706110100	0780906110100
12,00	6,00	70	25	0780406112100	0780606112100 *	0780706112100	0780906112100
12,00	6,00	75	25		0780606212100		
12,00	8,00	70	25		0780608112100		
16,00	6,00	75	30	0780406116100	0780606116100		
16,00	8,00	75	30		0780608116100		



Hartmetall Werkzeuge  
Tungsten carbide tools  
herramientas de metal duro



① Hartmetall-Frässtifte, Winkel, ohne Stirnverzahnung

② Tungsten carbide rotary burrs, inverted cone, without front cut

③ Puntas de avellanado de metal duro, angulares, sin dentado frontal



INOX



Diamant  
Diamond  
Diamante



Aluminium  
Aluminium  
Aluminio



DIN MY



DIN MX

Einzelverpackung  
Single packing  
Embalaje individual



DIN  
WKN

ISO  
N

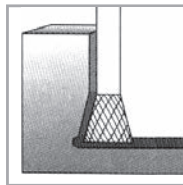

**INOX**

Herausragende Fräseleistung bei Edelstahl/Niro

*Outstanding milling performance in stainless steel*

*Rendimiento de fresado excelente en acero inoxidable/ acero niro*



d1 mm	d2 mm	l1 mm	l2 mm	0	1A	2	3
3,00	3,00	38	3				0781303103100
6,00	3,00	36	6				0781303106100
8,00	6,00	53	8				0781306108100
10,00	6,00	55	10				
12,00	6,00	57	12				0781306112100





6 TiN

DIN MX



9

SPECIAL STEEL

Nähere Informationen zu den einzelnen Zahnungen siehe Seite 261.

*Detailed information about the different cuts see on page 261.*

*Consulte en la página 261 información más detallada sobre todos los dentados.*

**SPECIAL STEEL**

Aggressive Geometrie - hoher Materialabtrag

*Aggressive geometry - high chip removal*

*Geometría agresiva - alta remoción de material*

d1 mm	d2 mm	l1 mm	l2 mm				
					Code 7816 Art.-Nr.		
3,00	3,00	38	3		0781603103100		
6,00	3,00	36	6		0781603106100		
8,00	6,00	53	8		0781606108100		
10,00	6,00	55	10		0781606110100		
12,00	6,00	57	12		0781606112100		



Hartmetall Werkzeuge  
 Tungsten carbide tools  
 herramientas de metal duro



① Hartmetall-Frässtifte, Spitzkegel

② Tungsten carbide rotary burrs, conical pointed nose

③ Puntas de avellanado de metal duro, cónicas puntiagudas



INOX



Diamant  
Diamond  
Diamante



Aluminium  
Aluminium  
Aluminio



DIN MY



DIN MX

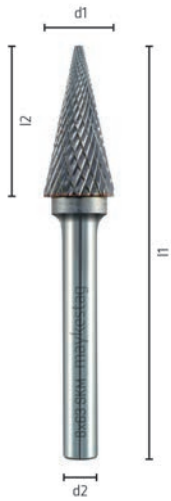

DIN  
SKM

ISO  
M

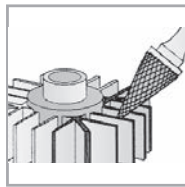

**INOX**

Herausragende Fräseleistung bei Edelstahl/Niro

*Outstanding milling performance in stainless steel*

*Rendimiento de fresado excelente en acero inoxidable/ acero niro*

Einzelverpackung  
Single packing  
Embalaje individual



\* Einzelverpackung mit SB  
Single packaging with tag  
Embalaje individual con gancho para autoservicio



d1	d2	l1	l2	0	1A	2	3
mm	mm	mm	mm	Code Art.-Nr.	Code Art.-Nr.	Code Art.-Nr.	Code 7833 Art.-Nr.
3,00	3,00	38	12				0783303103100
3,00	3,00	50	12				0783303203100
4,00	3,00	40	10				0783303104100
6,00	3,00	43	13				0783303106100
6,00	6,00	50	16				0783306106100
8,00	6,00	63	18				0783306108100
10,00	6,00	65	20				0783306110100
12,00	6,00	70	25				0783306112100
16,00	6,00	70	25				0783306116100





6 TiN

DIN MX



9

SPECIAL STEEL

Nähere Informationen zu den einzelnen Zahnungen siehe Seite 261.

*Detailed information about the different cuts see on page 261.*





*Consulte en la página 261 información más detallada sobre todos los dentados.*

**SPECIAL STEEL**

Aggressive Geometrie - hoher Materialabtrag

*Aggressive geometry - high chip removal*

*Geometría agresiva - alta remoción de material*

							
d1 mm	d2 mm	l1 mm	l2 mm	Code 7834 Art.-Nr.	Code 7836 Art.-Nr.	Code 7837 Art.-Nr.	Code Art.-Nr.
3,00	3,00	38	12	0783403103100	0783603103100	0783703103100	
3,00	3,00	50	12				
4,00	3,00	40	10				
6,00	3,00	43	13	0783403106100	0783603106100		
6,00	6,00	50	16	0783406106100	0783606106100 *	0783706106100	
8,00	6,00	63	18	0783406108100	0783606108100	0783706108100	
10,00	6,00	65	20	0783406110100	0783606110100 *	0783706110100	
12,00	6,00	70	25	0783406112100	0783606112100 *	0783706112100	
16,00	6,00	70	25	0783406116100	0783606116100		



Hartmetall Werkzeuge  
 Tungsten carbide tools  
 herramientas de metal duro



① Hartmetall-Frässtifte, Konus 90°

② Tungsten carbide rotary burrs, cone 90°

③ Puntas de avellanado de metal duro, cono de 90°



INOX



Diamant  
Diamond  
Diamante



Aluminium  
Aluminium  
Aluminio



DIN MY



DIN MX

Einzelverpackung  
Single packing  
Embalaje individual



DIN  
KSK

ISO  
K

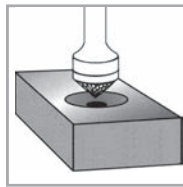

**INOX**

Herausragende Fräseleistung bei Edelstahl/Niro

*Outstanding milling performance in stainless steel*

*Rendimiento de fresado excelente en acero inoxidable/ acero niro*



d1 mm	d2 mm	l1 mm	l2 mm	0	1A	2	3	Code 7843 Art.-Nr.
3,00	3,00	38	2					0784303103100
4,00	6,00	50	3					0784306104100
5,00	3,00	34	4					0784303105100
6,00	6,00	50	5					0784306106100
8,00	6,00	53	8					0784306108100
10,00	6,00	55	10					0784306110100
12,00	6,00	57	12					0784306112100
16,00	6,00	61	16					0784306116100
20,00	6,00	65	20					0784306120100







6 TiN

DIN MX



9

SPECIAL STEEL

Nähere Informationen zu den einzelnen Zahnungen siehe Seite 261.

*Detailed information about the different cuts see on page 261.*

*Consulte en la página 261 información más detallada sobre todos los dentados.*

**SPECIAL STEEL**

Aggressive Geometrie -  
hoher Materialabtrag

*Aggressive geometry -  
high chip removal*

*Geometría agresiva  
- alta remoción de  
material*

d1 mm	d2 mm	l1 mm	l2 mm				
					Code 7846 Art.-Nr.		
3,00	3,00	38	2				
4,00	6,00	50	3				
5,00	3,00	34	4				
6,00	6,00	50	5				
8,00	6,00	53	8				
10,00	6,00	55	10		0784606110100		
12,00	6,00	57	12		0784606112100		
16,00	6,00	61	16				
20,00	6,00	65	20				



Hartmetall Werkzeuge  
*Herramientas de metal duro*



① Hartmetall-Frässtifte,  
Konus 60°

② Tungsten carbide rotary burrs,  
cone 60°

③ Puntas de avellanado de metal  
duro, cono de 60°



INOX



Diamant  
Diamond  
Diamante



Aluminium  
Aluminium  
Aluminio



DIN MY



DIN MX

Einzelverpackung  
Single packing  
Embalaje individual



DIN  
KSJ

ISO  
J

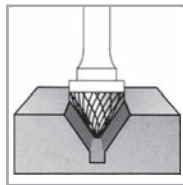

**INOX**

Herausragende Fräseleistung  
bei Edelstahl/Niro

*Outstanding milling  
performance in stainless  
steel*

*Rendimiento de fresado  
excelente en acero inoxidable/  
acero niro*



d1 mm	d2 mm	l1 mm	l2 mm	0	1A	2	3
				Code 7853 Art.-Nr.			
3,00	3,00	38	3				0785303103100
4,00	6,00	50	4				0785306104100
6,00	6,00	50	6				0785306106100
10,00	6,00	55	10				0785306110100
12,00	6,00	57	12				0785306112100
16,00	6,00	61	16				0785306116100





6 TiN

DIN MX



9

SPECIAL STEEL

Nähere Informationen zu den einzelnen Zahnungen siehe Seite 261.

*Detailed information about the different cuts see on page 261.*

*Consulte en la página 261 información más detallada sobre todos los dentados.*

**SPECIAL STEEL**

Aggressive Geometrie -  
hoher Materialabtrag

*Aggressive geometry -  
high chip removal*

*Geometría agresiva  
- alta remoción de  
material*

d1 mm	d2 mm	l1 mm	l2 mm	Zahnung			
				4	6	6 TiN	9
				Code 7856 Art.-Nr.			
3,00	3,00	38	3				
4,00	6,00	50	4				
6,00	6,00	50	6		0785606106100		
10,00	6,00	55	10		0785606112100		
12,00	6,00	57	12		0785606116100		
16,00	6,00	61	16				



Hartmetall Werkzeuge  
Tungsten carbide tools  
herramientas de metal duro



① Hartmetall-Frässtifte, Tropfen

② Tungsten carbide rotary burrs, oval

③ Puntas de avellanado de metal duro, lágrima



INOX



Diamant  
Diamond  
Diamante



Aluminium  
Aluminium  
Aluminio



DIN MY



DIN MX

Einzelverpackung  
Single packing  
Embalaje individual

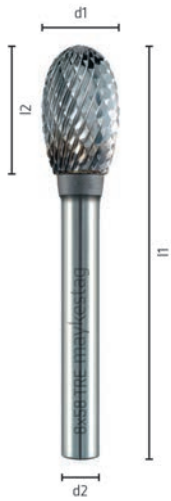

DIN  
TRE

ISO  
E

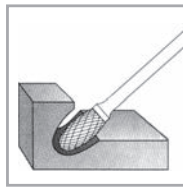

**INOX**

Herausragende Fräseleistung bei Edelstahl/Niro

*Outstanding milling performance in stainless steel*

*Rendimiento de fresado excelente en acero inoxidable/ acero niro*



d1 mm	d2 mm	l1 mm	l2 mm	0	1A	2	3	Code 7863 Art.-Nr.
3,00	3,00	38	6					0786303103100
4,00	3,00	36	6					0786303104100
4,00	6,00	50	6					
6,00	3,00	40	10					0786303106100
6,00	6,00	50	10					0786306106100
8,00	6,00	58	13					0786306108100
10,00	6,00	61	16					0786306110100
12,00	6,00	65	20					0786306112100
16,00	6,00	70	25					0786306116100





DIN MX



SPECIAL STEEL

Nähere Informationen zu den einzelnen Zahnungen siehe Seite 261.

*Detailed information about the different cuts see on page 261.*

*Consulte en la página 261 información más detallada sobre todos los dentados.*

**SPECIAL STEEL**

Aggressive Geometrie -  
hoher Materialabtrag

*Aggressive geometry -  
high chip removal*

*Geometría agresiva  
- alta remoción de  
material*

d1 mm	d2 mm	l1 mm	l2 mm	4		6		6 TiN		9	
				Code 7864 Art.-Nr.	Code 7866 Art.-Nr.	Code 7864 Art.-Nr.	Code 7866 Art.-Nr.	Code 7864 Art.-Nr.	Code 7866 Art.-Nr.		
3,00	3,00	38	6	0786403103100	0786603103100						
4,00	3,00	36	6		0786603104100						
4,00	6,00	50	6		0786606104100						
6,00	3,00	40	10	0786403106100	0786603106100						
6,00	6,00	50	10	0786406106100	0786606106100						
8,00	6,00	58	13	0786406108100	0786606108100						
10,00	6,00	61	16	0786406110100	0786606110100						
12,00	6,00	65	20	0786406112100	0786606112100						
16,00	6,00	70	25	0786406116100	0786606116100						



Hartmetall Werkzeuge  
Tungsten carbide tools  
herramientas de metal duro



**① Hartmetall-Frässtifte, Kugel**

**② Tungsten carbide rotary burrs, spherical**

**③ Puntas de avellanado de metal duro, cónicas**



INOX



Diamant  
Diamond  
Diamante



Aluminium  
Aluminium  
Aluminio



DIN MY



DIN MX

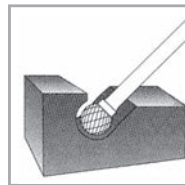

**INOX**

Herausragende Fräseleistung bei Edelstahl/Niro

Outstanding milling performance in stainless steel

Rendimiento de fresado excelente en acero inoxidable/ acero niro

Einzelverpackung  
Single packing  
Embalaje individual



\* Einzelverpackung mit SB  
Single packaging with tag  
Embalaje individual con gancho para autoservicio



d1 mm	d2 mm	l1 mm	l2 mm	0	1A	2	3
				Code 7878 Art.-Nr.			Code 7873 Art.-Nr.
2,50	3,00	38	2				0787303125100
3,00	3,00	33	2,5				0787303103100
3,00	3,00	38	2,5				
4,00	3,00	33	3				0787303104100
4,00	6,00	50	3				0787306104100
5,00	3,00	34	4				0787303105100
6,00	3,00	35	5				0787303106100
6,00	6,00	50	5				0787306106100
8,00	6,00	52	7				0787306108100
10,00	6,00	54	9	0787806110100			0787306110100
10,00	6,00	150	9				
12,00	6,00	55	10	0787806112100			0787306112100
12,00	6,00	150	10				
16,00	6,00	59	14				0787306116100
16,00	8,00	59	14				0787308116100
20,00	6,00	63	18				0787306120100





6 TiN

DIN MX



9

SPECIAL STEEL

Nähere Informationen zu den einzelnen Zahnungen siehe Seite 261.

*Detailed information about the different cuts see on page 261.*

*Consulte en la página 261 información más detallada sobre todos los dentados.*

**SPECIAL STEEL**

Aggressive Geometrie - hoher Materialabtrag

*Aggressive geometry - high chip removal*

*Geometría agresiva - alta remoción de material*

							
d1 mm	d2 mm	l1 mm	l2 mm	Code 7874 Art.-Nr.	Code 7876 Art.-Nr.	Code 7877 Art.-Nr.	
2,50	3,00	38	2			0787703125100	
3,00	3,00	33	2,5	0787403103100	0787603103100		
3,00	3,00	38	2,5			0787703103100	
4,00	3,00	33	3	0787403104100			
4,00	6,00	50	3	0787406104100	0787606104100		
5,00	3,00	34	4				
6,00	3,00	35	5	0787403106100	0787603106100		
6,00	6,00	50	5	0787406106100	0787606106100	0787706106100	
8,00	6,00	52	7	0787406108100	0787606108100	0787706108100	
10,00	6,00	54	9	0787406110100	0787606110100 *	0787706110100	
10,00	6,00	150	9		0787606210100		
12,00	6,00	55	10	0787406112100	0787606112100 *		
12,00	6,00	150	10		0787606212100		
16,00	6,00	59	14	0787406116100	0787606116100		
16,00	8,00	59	14				
20,00	6,00	63	18	0787406120100	0787606120100		



Hartmetall Werkzeuge  
 Tungsten carbide tools  
 herramientas de metal duro



① Hartmetall-Frässtifte, Rundbogen

② Tungsten carbide rotary burrs, arc round nose

③ Puntas de avellanado de metal duro, arco circular



INOX



Diamant  
Diamond  
Diamante



Aluminium  
Aluminium  
Aluminio

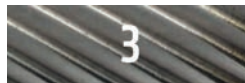

DIN MY



DIN MX



DIN  
RBF

ISO  
F

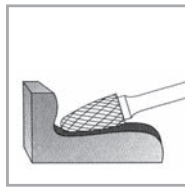

**INOX**

Herausragende Fräseleistung bei Edelstahl/Niro

Outstanding milling performance in stainless steel

Rendimiento de fresado excelente en acero inoxidable/ acero niro

Einzelverpackung  
Single packing  
Embalaje individual



\* Einzelverpackung mit SB  
Single packaging with tag  
Embalaje individual con gancho para autoservicio



d1 mm	d2 mm	l1 mm	l2 mm	0	1A	2	3
				Code 7880 Art.-Nr.	Code 7888 Art.-Nr.	Code 7882 Art.-Nr.	Code 7883 Art.-Nr.
3,00	3,00	38	12				0788303103100
4,00	3,00	40	10				0788303104100
6,00	3,00	43	13				0788303106100
6,00	6,00	50	18	0788006106100		0788206106100	0788306106100
6,00	6,00	150	13				
8,00	6,00	63	18	0788006108100		0788206108100	0788306108100
10,00	6,00	65	20	0788006110100	0788806110100	0788206110100	0788306110100
10,00	6,00	150	20				
12,00	6,00	70	25	0788006112100	0788806112100	0788206112100	0788306112100
12,00	6,00	150	25				
12,00	8,00	70	25				
16,00	6,00	75	30		0788806116100		0788306116100
20,00	6,00	75	30				







DIN MX

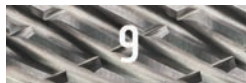

SPECIAL STEEL

Nähere Informationen zu den einzelnen Zahnungen siehe Seite 261.

*Detailed information about the different cuts see on page 261.*

*Consulte en la página 261 información más detallada sobre todos los dentados.*

**SPECIAL STEEL**

Aggressive Geometrie - hoher Materialabtrag

*Aggressive geometry - high chip removal*

*Geometría agresiva - alta remoción de material*

							
d1 mm	d2 mm	l1 mm	l2 mm	Code 7884 Art.-Nr.	Code 7886 Art.-Nr.	Code 7887 Art.-Nr.	Code 7889 Art.-Nr.
3,00	3,00	38	12	0788403103100	0788603103100		
4,00	3,00	40	10				
6,00	3,00	43	13	0788403106100	0788603106100		
6,00	6,00	50	18	0788406106100	0788606106100 *		0788906106100
6,00	6,00	150	13	0788406206100			
8,00	6,00	63	18	0788406108100	0788606108100	0788706108100	0788906108100
10,00	6,00	65	20	0788406110100		0788706110100	0788906110100
10,00	6,00	150	20	0788406210100			
12,00	6,00	70	25	0788406112100	0788606112100 *	0788706112100	0788906112100
12,00	6,00	150	25	0788406212100			
12,00	8,00	70	25		0788608112100		
16,00	6,00	75	30	0788406116100	0788606116100		
20,00	6,00	75	30		0788606120100		



Hartmetall Werkzeuge  
 Tungsten carbide tools  
 herramientas de metal duro



① Hartmetall-Frässtifte, Rundkegel

② Tungsten carbide rotary burrs, conical round nose

③ Puntas de avellanado de metal duro, cónico circular



INOX



Diamant  
Diamond  
Diamante



Aluminium  
Aluminium  
Aluminio



DIN MY



DIN MX

Einzelverpackung  
Single packing  
Embalaje individual

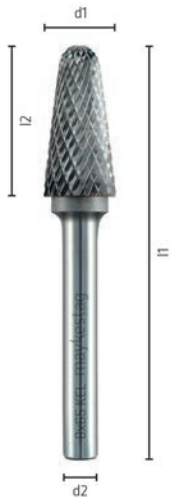

DIN  
KEL

ISO  
L

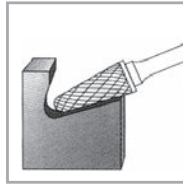

**INOX**

Herausragende Fräseleistung bei Edelstahl/Niro

*Outstanding milling performance in stainless steel*

*Rendimiento de fresado excelente en acero inoxidable/ acero niro*



d1 mm	d2 mm	l1 mm	l2 mm	0	1A	2	3
				Code 7890 Art.-Nr.	Code 7898 Art.-Nr.	Code 7893 Art.-Nr.	
3,00	3,00	38	14				0789303103100
4,00	3,00	44	14				0789303104100
4,00	6,00	50	16				
6,00	3,00	48	18				0789303106100
6,00	6,00	50	20				0789306106100
8,00	6,00	65	20	0789006108100			0789306108100
10,00	6,00	65	20	0789006110100	0789806110100		0789306110100
12,00	6,00	70	25	0789006112100	0789806112100		0789306112100
12,00	6,00	75	30				
16,00	6,00	75	30		0789806116100		0789306116100





6 TiN

DIN MX



9

SPECIAL STEEL

Nähere Informationen zu den einzelnen Zahnungen siehe Seite 261.

*Detailed information about the different cuts see on page 261.*

*Consulte en la página 261 información más detallada sobre todos los dentados.*

**SPECIAL STEEL**

Aggressive Geometrie -  
hoher Materialabtrag

*Aggressive geometry -  
high chip removal*

*Geometría agresiva  
- alta remoción de  
material*

							
d1 mm	d2 mm	l1 mm	l2 mm	Code 7894 Art.-Nr.	Code 7896 Art.-Nr.		Code 7899 Art.-Nr.
3,00	3,00	38	14	0789403103100	0789603103100		
4,00	3,00	44	14		0789603104100		
4,00	6,00	50	16		0789606104100		
6,00	3,00	48	18	0789403106100			
6,00	6,00	50	20	0789406106100	0789606106100		
8,00	6,00	65	20	0789406108100	0789606108100		
10,00	6,00	65	20	0789406110100	0789606110100		0789906110100
12,00	6,00	70	25	0789406112100	0789606112100		0789906112100
12,00	6,00	75	30		0789606312100		
16,00	6,00	75	30	0789406116100	0789606116100		



Hartmetall Werkzeuge  
Tungsten carbide tools  
herramientas de metal duro



① Hartmetall-Frässtifte,  
Flamme

② Tungsten carbide rotary burrs,  
flame

③ Puntas de avellanado de metal  
duro, llama



INOX



Diamant  
Diamond  
Diamante



Aluminium  
Aluminium  
Aluminio



DIN MY



DIN MX

Einzelverpackung  
Single packing  
Embalaje individual

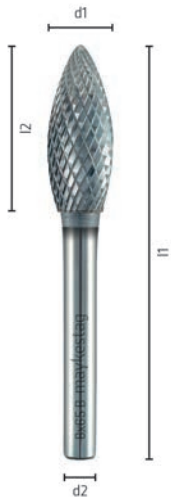

DIN  
B

ISO  
H

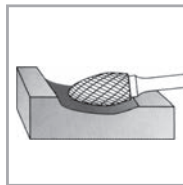

**INOX**

Herausragende Fräseleistung  
bei Edelstahl/Niro

*Outstanding milling  
performance in stainless  
steel*

*Rendimiento de fresado  
excelente en acero inoxidable/  
acero niro*



d1 mm	d2 mm	l1 mm	l2 mm	0	1A	2	3	Code 7903 Art.-Nr.
6,00	6,00	57	20					
8,00	6,00	65	20					0790306108100
10,00	6,00	70	25					0790306110100
12,00	6,00	75	30					0790306112100
16,00	6,00	77	32					





6 TiN

DIN MX



9

SPECIAL STEEL

Nähere Informationen zu den einzelnen Zahnungen siehe Seite 261.

*Detailed information about the different cuts see on page 261.*

*Consulte en la página 261 información más detallada sobre todos los dentados.*

**SPECIAL STEEL**

Aggressive Geometrie - hoher Materialabtrag

*Aggressive geometry - high chip removal*

*Geometría agresiva - alta remoción de material*

d1 mm	d2 mm	l1 mm	l2 mm	4		6		6 TiN		9	
				Code 7904 Art.-Nr.	Code 7906 Art.-Nr.	Code 7904 Art.-Nr.	Code 7906 Art.-Nr.	Code 7904 Art.-Nr.	Code 7906 Art.-Nr.		
6,00	6,00	57	20		0790606106100						
8,00	6,00	65	20	0790406108100	0790606108100						
10,00	6,00	70	25	0790406110100	0790606110100						
12,00	6,00	75	30	0790406112100	0790606112100						
16,00	6,00	77	32	0790406116100	0790606116100						



Hartmetall Werkzeuge  
Tungsten carbide tools  
herramientas de metal duro



① Kassetten, Sets

Ⓔ Cassettes, sets

Ⓔ Cajas, juegos

Hartmetall-Frässtifteset, Zahnung 6 BOX 3 <i>Tungsten carbide rotary burrs set, Cut 6 BOX 3</i> <i>Juego de puntas de avellanado de metal duro, dentado 6 BOX 3</i>		Hartmetall-Frässtifteset, Zahnung 6 BOX 10 <i>Tungsten carbide rotary burrs set, Cut 6 BOX 10</i> <i>Juego de puntas de avellanado de metal duro, dentado 6 BOX 10</i>		Hartmetall-Set Frässtifte/Senker BOX 5 <i>Tungsten carbide set rotary burrs/countersinks BOX 5</i> <i>Juego de puntas de avellanado/avellanadores cónicos de metal duro BOX 5</i>	
					
3-tlg. / 3-pcs. / 3-unid. Kunststoffbox / Plastic box / Caja de plástico Art.-Nr. 0776000003100		10-tlg. / 10-pcs. / 10-unid. Kunststoffbox / Plastic box / Caja de plástico Art.-Nr. 0776000005100		5-tlg. / 5-pcs. / 5-unid. Kunststoffbox / Plastic box / Caja de plástico Art.-Nr. 0776000002100	
Ø mm	Stk. <sup>(1)</sup> pc. <sup>(1)</sup>	Ø mm	Stk. <sup>(1)</sup> pc. <sup>(1)</sup>	Ø mm	Stk. <sup>(1)</sup> pc. <sup>(1)</sup>
HM-Frässtift		HM-Frässtift		HM-Frässtift	
Ø 10 x 65 mm, ZYA-S	1	Ø 6 x 50 mm / 12 x 70 mm, ZYA-S	1	Ø 10x65, ZYA-S	1
Ø 10 x 65 mm, WRC	1	Ø 10 x 54 mm / 12 x 55 mm, KUD	1	Ø 10x65, WRC	1
Ø 10 x 65 mm, SPG	1	Ø 6 x 50 mm / 12 x 70 mm, WRC	1	Ø 10x65, SPG	1
		Ø 6 x 50 mm / 12 x 70 mm, RBF	1	MAYKESTAG	
		Ø 6 x 50 mm / 10 x 65 mm, SPG	1	HSS Cobalt Kegelsenker Ø 10,40 / 12,40	1

<sup>(1)</sup> Stück je Abmessung / Pieces each dimension / Piezas por diámetro

**D Beschreibung der Verzahnungen**

**E Description of cuts**

**ES Descripción de los dentados**

<p><b>Zahnung 0 (INOX):</b> Herausragende Fräsleistung bei Edelstahl sowie ferritischen, austenitischen und martensitischen Materialien.</p> <p><b>Cut 0 (INOX):</b> <i>Outstanding milling performance in stainless steel as well as ferritic, austenitic and martensitic materials.</i></p> <p><b>Dentado 0 (INOX):</b> <i>Rendimiento de fresado excelente de acero inoxidable y de los materiales ferríticos, austeníticos y martensíticos.</i></p>	<p><b>Zahnung 1A (Aluminium)</b> Für Aluminium und Aluminiumlegierungen sowie Kunststoffe.</p> <p><b>Cut 1A (aluminium):</b> <i>Suitable for aluminium and aluminium alloys as well as plastics.</i></p> <p><b>Dentado 1A (aluminio):</b> <i>Para aluminio y aleaciones de aluminio, así como plástico.</i></p>	<p><b>Zahnung 2</b> Für Stähle hoher Festigkeit, Inox, Stahlguss, Schweißnähte und Messing.</p> <p><b>Cut 2:</b> <i>Suitable for steels with high tensile strength, inox, cast steels, welding seams and brass</i></p> <p><b>Dentado 2:</b> <i>Para aceros de alta resistencia, acero inoxidable, fundición de acero, soldaduras y latón.</i></p>	<p><b>Zahnung 3 (DIN MY):</b> Für allgemeine Arbeiten wie Entgraten, Fasen, Kantenbrechen mit sauberer Oberfläche. Für Stähle mit hoher Festigkeit, Schweißnähte.</p> <p><b>Cut 3 (DIN MY):</b> <i>For general purposes such as deburring, chamfering and smoothing edges with clean surface. Suitable for steels with high tensile strength and welding seams.</i></p> <p><b>Dentado 3 (DIN MY):</b> <i>Para trabajos generales como desbarbado, biselado, redondeado de cantos con superficies limpia. Para aceros de alta resistencia, soldaduras</i></p>

<p><b>Zahnung 4 (Diamant):</b> Hohe Oberflächengüte für gehärtete Stähle, Schweißnähte hoher Festigkeit.</p> <p><b>Cut 4 (diamond):</b> <i>Suitable for hardened steels with excellent surface quality and welding seams with high tensile strength.</i></p> <p><b>Dentado 4 (diamante):</b> <i>Acabado superficial excelente para aceros templados, soldaduras de alta resistencia.</i></p>	<p><b>Zahnung 6 (DIN MX):</b> Mit dieser Universalverzahnung werden auch bei härtesten Werkstoffen und Schweißnähten glatte Oberflächen erzielt, ideal für den Werkzeug- und Formenbau.</p> <p><b>Cut 6 (DIN MX):</b> <i>With this universal cutting profile even hardest materials and welding seams can be machined with best finishing quality. Ideal for the tool and mould industry</i></p> <p><b>Dentado 6 (DIN MX):</b> <i>Con este dentado universal se logran superficies lisas con los materiales más duros y soldaduras, ideal para la fabricación de herramientas y moldes.</i></p>	<p><b>Zahnung 9 (SPECIAL STEEL):</b> Speziell entwickelte Geometrie für Stahl- und Gusseisenanwendungen. Hervorragende Zerspanungsleistung und hoher Materialabtrag.</p> <p><b>Cut 9 (SPECIAL STEEL):</b> <i>Special designed geometry for steel and cast iron applications. Excellent cutting performance and high chip removal.</i></p> <p><b>Dentado 9 (SPECIAL STEEL):</b> <i>Geometría especialmente diseñada para aplicaciones de acero y acero de fundición. Rendimiento de arranque de virutas excelente y alta remoción de material.</i></p>



Hartmetall Werkzeuge  
Tungsten carbide tools  
herramientas de metal duro

**① Anwendung der Zahnungen, Schnittwertempfehlung**

Werkstoffgruppen		Bearbeitung	Zahnung	Schnittgeschwindigkeit $v_c$ (m/min)	
<b>Stahl- und Stahlgusswerkstoffe</b>	ungehärtete, nicht vergütete Stähle < 1.200 N/mm <sup>2</sup> ( < 35 HRC)	Baustähle, Kohlenstoffstähle, Werkzeugstähle, unlegierte Stähle, Einsatzstähle, Stahlguss	Grobe Zerspanung	2	500-700
				6 TiN	450-600
			6	450-600	
			9	850-1.100	
	gehärtete, vergütete Stähle > 1.200 N/mm <sup>2</sup> (> 35 HRC)	Werkzeugstähle, Vergütungsstähle, legierte Stähle, Stahlguss	Grobe Zerspanung	3,4	500-600
				2	250-350
			6 TiN	250-350	
			6	250-350	
Feine Zerspanung	9	550-800			
	3,4	350-450			
<b>Inox</b>	rost- und säurebeständige Stähle	austenitisch und ferritisch	Grobe Zerspanung	0	550-800
				2	300-400
				6 TiN	250-350
			Feine Zerspanung	6	250-350
				3,4	350-450
				2	350-450
<b>NE-Metalle</b>	weiche NE-Metalle	Alu-Legierungen, Messing, Zink, Kupfer	Grobe Zerspanung	1A	600-900
				2	500-700
				6 TiN	400-600
			Feine Zerspanung	2	800-900
				2	250-350
	harte NE-Metalle	Titan, Titanlegierungen, Bronze, Alu-Legierungen mit hohem Si-Anteil	Grobe Zerspanung	6,6 TiN	250-450
				3,4	350-450
			Feine Zerspanung	2	300-450
	6	300-450			
	hochwarmfeste Werkstoffe	Nickelbasislegierungen, Ni-Co Legierungen	Grobe Zerspanung	3,4	350-500
2				350-500	
Feine Zerspanung			3,4	350-500	
<b>Gusseisenwerkstoffe</b>		Grauguss, Sphäroguss	Grobe Zerspanung	6 TiN	600-800
				2	500-700
				3	450-600
				6	450-600
			Feine Zerspanung	9	850-1.100
				3,4	500-600
<b>Kunststoffe</b>		faserverstärkte Kunststoffe, thermoplastische Kunststoffe, Hartgummi	Grobe Zerspanung	1A	500-900
				6 TiN	500-900
			Feine Zerspanung	2	500-900

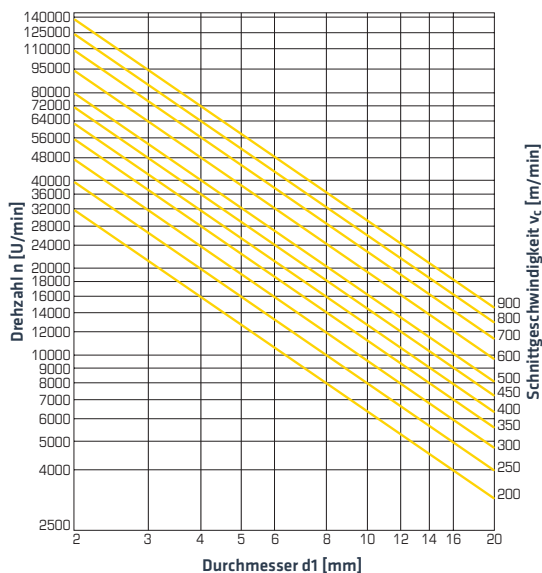

**Einsatzempfehlungen:**

Verwenden Sie nach Möglichkeit die Höchstwerte.

**Ausnahmen:**

- Senkarbeiten mit allseitiger Umschlingung des Frässtiftes, Drehzahl < 3000 U/min möglich.
- Stationärer Einsatz, Drehzahl < 3000 U/min möglich.
- Werkstoffe mit schlechter Wärmeleitfähigkeit, Drehzahl senken, um Blaufärbung des Frässtiftes zu vermeiden.

**Sicherheitshinweise:**

Augenschutz benutzen! Je härter der Werkstoff, desto feiner die Zahnung wählen. Nur schlagfreie Spannfutter verwenden!



**E** Application of different cuts, recommended cutting conditions

Material groups			Machining	Cut	Cutting speed $v_c$ (m/min)	
<b>Steels and cast steels</b>	non-hardened, non heat treatable steels < 1.200 N/mm <sup>2</sup> (< 35 HRC)	Structural steels, carbon steels, tool steels, unalloyed steels, case hardening steels, cast steels	Rough cutting	2	500-700	
				6 TiN	450-600	
				6	450-600	
				9	850-1.100	
	hardened, heat treatable steels > 1.200 N/mm <sup>2</sup> (> 35 HRC)	Tool steels, heat treatable steels, alloyed steels, cast steels	Rough cutting	3,4	500-600	
				2	250-350	
				6 TiN	250-350	
				6	250-350	
Fine cutting		9	550-800			
		3,4	350-450			
<b>Inox</b>	stainless and acid-resistant steels	austenitic and ferritic	Rough cutting	0	550-800	
				2	300-400	
				6 TiN	250-350	
			Fine cutting		6	250-350
					3,4	350-450
<b>Non-ferrous metals</b>	soft non-ferrous metals	Alu-alloys, brass, zinc, copper	Rough cutting	1A	600-900	
				2	500-700	
				6 TiN	400-600	
			Fine cutting		2	800-900
	Rough cutting				2	250-350
					6,6 TiN	250-450
	Fine cutting		3,4	350-450		
			high-temperature materials	Ni-alloys, Ni-Co alloys	Rough cutting	
	6	300-450				
	Fine cutting				3,4	350-500
<b>Cast iron</b>						Grey cast iron, spheroidal cast iron
	2	500-700				
	3	450-600				
	6	450-600				
	9	850-1.100				
	Fine cutting	3,4	500-600			
<b>Plastics</b>		fibre-reinforced plastics, thermoplastics, hard plastics	Rough cutting	1A	500-900	
				6 TiN	500-900	
			Fine cutting	2	500-900	

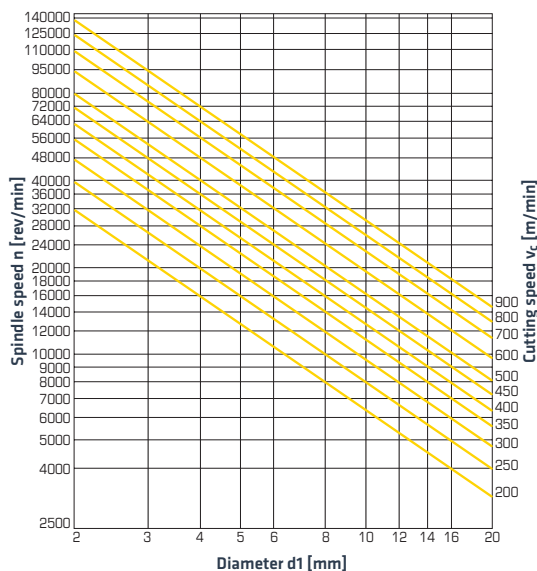

**Hints for use:**  
If possible use the highest values.

- Exceptions:**
- Counterboring with totally engagement of the rotary burr, recommended spindle speed < 3000 rpm.
  - Stationary use, recommended spindle speed < 3000 rpm.
  - Materials with bad heat conductivity, reduce spindle speed to avoid superheating of the rotary burr.

**Safety hints:**  
Use eye-protection! The harder the material use the more finely tooth. Use only chucks free from chatter!



Hartmetall Werkzeuge  
Tungsten carbide tools  
herramientas de metal duro

ES **Aplicación de dentados,  
velocidades recomendadas**

Materiales		Procesamiento	Dentado	Velocidades V <sub>c</sub> (m/min)				
<b>Acero, fundición de acero</b>	Acero no templado, no tratado < 1200 N/mm <sup>2</sup> (< 35 HRC)	Acero de construcción, acero carbonizado, acero para herramientas, acero no aleado, acero cementado, fundición de acero	Desbarbado	2	500-700			
				6 TiN	450-600			
				6	450-600			
				9	850-1.100			
	Acero templado, tratado > 1.200 N/mm <sup>2</sup> (> 35 HRC)	Acero para herramientas, acero tratado, acero aleado, fundición de acero	Desbarbado	Acabado	3,4	500-600		
					2	250-350		
					6 TiN	250-350		
					6	250-350		
				9	550-800			
				3,4	350-450			
				0	550-800			
				2	300-400			
<b>Acero inoxidable</b>	Acero inoxidable y acero resistente a los ácidos	Acero austenítico, acero ferrítico	Desbarbado	6 TiN	250-350			
				6	250-350			
				2	350-450			
				3,4	350-450			
			<b>Materiales no férricos</b>	Materiales no férricos blandos	Aleaciones de aluminio, latón, cinc y cobre	Desbarbado	1A	600-900
							2	500-700
							6 TiN	400-600
							2	800-900
Materiales no férricos duros	Titanio, aleaciones de titanio, bronce, aleaciones de aluminio con contenido elevado de Si	Desbarbado		Acabado	2	250-350		
					6,6 TiN	250-450		
					3,4	350-450		
					2	300-450		
Materiales resistentes al calor	Aleaciones basadas en níquel, aleaciones de Ni-Co	Desbarbado	Acabado	6	300-450			
				3,4	350-500			
				6 TiN	600-800			
				2	500-700			
<b>Hierro</b>		Hierro fundido gris, fundición nodular	Desbarbado	3	450-600			
				6	450-600			
				9	850-1.100			
				3,4	500-600			
							2	500-700
							3	450-600
							6	450-600
							9	850-1.100
<b>Plástico</b>		Plástico reforzados con fibras, termoplásticos, goma dura	Desbarbado	1A	500-900			
				6 TiN	500-900			
				2	500-900			

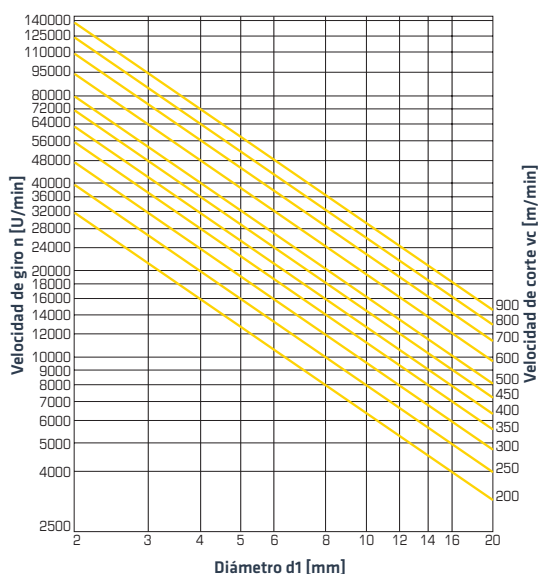

**Aplicación:**

Usar, si es posible, los valores más elevados.

**Excepciones:**

- Trabajos de avellanado en todo el perímetro, velocidad posible < 3000.
- Procesamiento fijo, velocidad posible < 3000.
- Materiales con mala conducción térmica, reducir la velocidad para evitar que las puntas de avellanado adquieran un color azul.

**Normas de seguridad:**

Usar gafas de protección. Para materiales muy tenaces, elegir un dentado fino, no emplear mordazas de sujeción.

**D** Drehzahlen und Vorschübe

**E** Spindle speeds and feeds

**ES** Velocidades y avances

Die angegebenen Schnittwertempfehlungen beziehen sich auf Standardanwendungen.

The recommended cutting data refer to standard applications.

Las recomendaciones indicadas de los valores de corte se refieren a aplicaciones estándar.

n: Drehzahl U/min  
f: Vorschub mm/U

n: Spindle speed rpm  
f: Feed mm/rev

n: Velocidad r.p.m.  
f: Avance mm/giro

Vollhartmetall-Spiralbohrer / Solid carbide drills / Brocas espirales de metal duro y macizo



Ø mm	Code 6147		Code 6146		Code 6157		Code 6156		Ti	Cu Ms Ni Zn	Alu	G							
	n	f	n	f	n	f	n	f											
0,5	20000	0,02	20000	0,02	20000	0,01	20000	0,01	19099	0,01	20000	0,02	20000	0,01					
1,0	20000	0,03	19099	0,03	19099	0,02	17507	0,02	9549	0,02	20000	0,02	20000	0,03					
2,0	11141	0,04	9549	0,04	9549	0,03	8754	0,03	4775	0,03	11141	0,03	4775	0,03					
3,0	7427	0,07	6366	0,07	6366	0,06	5836	0,06	3183	0,06	7427	0,06	3183	0,06					
4,0	5570	0,09	4775	0,09	4775	0,08	4377	0,08	2387	0,08	5570	0,08	2387	0,07					
5,0	4456	0,11	3820	0,11	3820	0,10	3501	0,10	1910	0,10	4456	0,10	1910	0,09					
6,0	3714	0,12	3183	0,12	3183	0,11	2918	0,11	1592	0,11	3714	0,11	1592	0,10					
7,0	3183	0,13	2728	0,13	2728	0,12	2501	0,12	1364	0,12	3183	0,12	1364	0,11					
8,0	2785	0,15	2387	0,15	2387	0,13	2188	0,13	1194	0,13	2785	0,13	1194	0,12					
9,0	2476	0,16	2122	0,16	2122	0,14	1945	0,14	1061	0,14	2476	0,14	1061	0,13					
10,0	2228	0,17	1910	0,17	1910	0,15	1751	0,15	955	0,15	2228	0,15	955	0,14					
11,0	2026	0,18	1736	0,18	1736	0,16	1592	0,16	868	0,16	2026	0,16	868	0,15					
12,0	1857	0,20	1592	0,20	1592	0,17	1459	0,17	796	0,17	1857	0,17	796	0,16					
13,0	1714	0,21	1469	0,21	1469	0,19	1347	0,19	735	0,19	1714	0,19	735	0,17					
14,0	1592	0,23	1364	0,23	1364	0,20	1251	0,20	682	0,20	1592	0,20	682	0,18					
15,0	1485	0,24	1273	0,24	1273	0,21	1167	0,21	637	0,21	1485	0,21	637	0,19					
16,0	1393	0,25	1194	0,25	1194	0,22	1094	0,22	597	0,22	1393	0,22	597	0,20					
17,0	1311	0,26	1123	0,26	1123	0,23	1030	0,23	562	0,23	1311	0,23	562	0,21					
18,0	1238	0,26	1061	0,26	1061	0,23	973	0,23	531	0,23	1238	0,23	531	0,21					
19,0	1173	0,27	1005	0,27	1005	0,24	921	0,24	503	0,24	1173	0,24	503	0,22					
20,0	1114	0,28	955	0,28	955	0,25	875	0,25	477	0,25	1114	0,25	477	0,23					
Kühlung Coolant Refrigeración	E		E		E		E		E		T/E		E		E		E		T/A

E: Emulsion | Emulsion | emulsión, O: Öl | Oil | aceite, T: trocken | dry | seco, D: Druckluft | compressed air | aire comprimido, W: Wasser | Water | agua, A: Luft | Air | aire



Hartmetall Werkzeuge  
Tungsten carbide tools  
herramientas de metal duro

Vollhartmetall-Kegelsenker, DIN 335 C, 90° / Solid carbide countersinks, DIN 335 C, 90° / Avellanador cónico de metal duro y macizo, DIN 335 C, 90°



Ø mm	Code 6637		Code 6530		Code 6407		Code 6405		Cu Ms Ni Zn	Alu	Ti	GRAUGUSS CAST IRON GISHA GRIGIA								
	n	f	n	f	n	f	n	f												
5,3	3604	0,07	3003	0,05	2703	0,05	1081	0,04	961	0,05	1501	0,07	961	0,05	4504	0,09	4504	0,09	2402	0,11
5,8	3293	0,08	2744	0,06	2470	0,06	988	0,04	878	0,05	1372	0,07	878	0,05	4116	0,10	4116	0,10	2195	0,12
6,3	3032	0,08	2526	0,06	2274	0,06	909	0,04	808	0,05	1263	0,07	808	0,05	3789	0,10	3789	0,10	2021	0,12
7,3	2616	0,09	2180	0,07	1962	0,07	785	0,04	698	0,05	1090	0,07	698	0,05	3270	0,11	3270	0,11	1744	0,13
8,3	2301	0,09	1918	0,07	1726	0,07	690	0,05	614	0,06	959	0,08	614	0,06	2876	0,11	2876	0,11	1534	0,13
9,4	2032	0,10	1693	0,08	1524	0,08	610	0,05	542	0,06	847	0,08	542	0,06	2540	0,12	2540	0,12	1355	0,14
10,4	1836	0,10	1530	0,08	1377	0,08	551	0,05	490	0,06	765	0,08	490	0,06	2296	0,12	2296	0,12	1224	0,14
12,4	1540	0,11	1284	0,09	1155	0,09	462	0,06	411	0,06	642	0,10	411	0,06	1925	0,13	1925	0,13	1027	0,16
13,4	1425	0,11	1188	0,09	1069	0,09	428	0,07	380	0,07	594	0,10	380	0,07	1782	0,13	1782	0,13	950	0,16
14,4	1326	0,12	1105	0,10	995	0,10	398	0,07	354	0,07	553	0,11	354	0,07	1658	0,14	1658	0,14	884	0,17
16,5	1157	0,12	965	0,10	868	0,10	347	0,08	309	0,07	482	0,12	309	0,07	1447	0,14	1447	0,14	772	0,18
19,5	979	0,14	816	0,12	735	0,12	294	0,09	261	0,08	408	0,15	261	0,08	1224	0,17	1224	0,17	653	0,20
20,5	932	0,14	776	0,12	699	0,12	279	0,09	248	0,08	388	0,16	248	0,08	1165	0,18	1165	0,18	621	0,20
25,0	764	0,18	637	0,14	573	0,14	229	0,10	204	0,09	318	0,20	204	0,09	955	0,22	955	0,22	509	0,24
31,0	616	0,20	513	0,16	462	0,16	185	0,11	164	0,10	257	0,22	164	0,10	770	0,24	770	0,24	411	0,27
<b>Kühlung Coolant Refrigeración</b>	E		E		E		E		E		E		E		E		E		T	

E: Emulsion | Emulsion | emulsión, O: Öl | Oil | aceite, T: trocken | dry | seco, D: Druckluft | compressed air | aire comprimido, W: Wasser | Water | agua, A: Luft | Air | aire



Hartmetall Werkzeuge  
Tungsten carbide tools  
herramientas de metal duro



# GEWINDEWERKZEUGE

// GEWINDEBOHRER UND SCHNEIDEISEN, SENKWERKZEUGE,  
SCHÄLWERKZEUGE



**E TAPS AND DIES**

- // TAPS AND DIES
- // COUNTERSINKS
- // CONECUT

**ES HERRAMIENTAS PARA ROSCAR**

- // MACHOS Y TERRAJAS
- // HERRAMIENTAS PARA AVELLANAR
- // HERRAMIENTAS PARA ESCARPAR

Übersicht

Overview

Resumen

								
Norm / Estándar	DIN 352	DIN 352	DIN 5157	DIN 352	DIN 1814			
Gewindeart / Type of thread / Tipo de rosca	M	M	G	M	M + G	M	M	M
Typ / Type / Tipo								
Schneidstoff / Cutting material / Material de corte	HSS-Co5	HSS	HSS	HSS				
Toleranz / Tolerance / Tolerancia	ISO 2 6H	ISO 2 6H		ISO 2 6H				
Anschnitt / Chamfer / Sección	C	C	C	A				
Drallwinkel / Spiral angle / Inclinación de hélice								
Beschichtung / Coating / Recubrimiento								
Schaft / Shank / Eje								
Ø mm	M 3 - M 10	M 2 - M 12	G1/8" - G1/2"	M 2 - M 12	Nr. 1 1/2 + 3	3,00 - 12,00	3,00 - 18,00	M 5 - M 20
Code / Código	717	707	706	708	712, 5430	713	902	701
Seite / Page / Página	274	275	276	277	278	278	278	278
Geeignet für / Suitable for / Adecuada para								
 <b>Allgemeine Baustähle</b> Structural steels Aceros de construcción generales								
 <b>Automatenstähle</b> Free cutting steels Aceros de corte fácil								
 <b>Unlegierte Vergütungsstähle</b> Unalloyed heat treatable steels Aceros para bonifi car no aleados								
 <b>Legierte Vergütungsstähle</b> Alloyed heat treatable steels Aceros para bonifi car aleados								
 <b>Rostfreie Stähle</b> Stainless steels Aceros inoxidables								
 <b>Grauguss, Temporguss</b> Grey cast iron, malleable cast iron Hierro fundido gris, fundición maleable								
 <b>Kupfer, Messing</b> Copper, brass Cobre, latón								
 <b>Aluminium</b> Aluminio Aluminio								
 <b>Kunststoffe</b> Plastics Plásticos								



Übersicht

Overview

Resumen

WN	DIN EN 22568	DIN 371 / DIN 376				WN	WN	DIN 334	DIN 335	DIN 335
M	M + G	M	M	M	M	M	M			
								60°	90°	90°
HSS		HSS-Co5	HSS-Co5	HSS	HSS	HSS	HSS	HSS-Co5	HSS-Co5	HSS-Co5
6g		ISO 2 6H	ISO 2 6H	ISO 2 6H	ISO 2 6H	ISO 2 6H	ISO 2 6H			
		B	C	B	C	A	A			
			35°		35°					
										ALUNIT®
M 2 - M 12	Nr. 4	M 3 - M 12	M 3 - M 12	M 3 - M 12	M 3 - M 12	M 3 - M 10	M 3 - M 10	6,30 - 25,00	6,30 - 31,00	6,30 - 31,00
710	711	704	714	709	719	702	703	2270	2390	2397
279	280	281	282	283	284	285	286	287	288	288





Gewinde-, Senk- und Schälwerkzeuge  
Taps, dies, countersinks and conecut  
herramientas para roscar, avellanar y escarpar

Übersicht

Overview

Resumen

								
								
Norm / Estándar	DIN 335		DIN 335		DIN 335		DIN 335	
Typ / Type / Tipo	90°	90°	90°	90°	90°	90°	90°	90°
Schneidstoff / Cutting material / Material de corte	HSS-Co5	HSS-Co5	HSS-Co5	HSS-Co5	HSS-Co5	HSS-Co5	HSS	HSS
Beschichtung / Coating / Recubrimiento		ALUNIT®		ALUNIT®		ALUNIT®		
Schaft / Shank / Eje								
Ø mm	6,30 - 31,00	6,30 - 31,00	6,30 - 31,00	6,30 - 31,00	4,30 - 31,00	5,00 - 31,00	6,30 - 31,00	6,30 - 25,00
Code / Código	2380	2387	2340	2347	2290	2297	2320	2292
Seite / Page / Página	290	290	292	292	294	294	297	299
Geeignet für / Suitable for / Adecuada para								
 <b>Allgemeine Baustähle</b> Structural steels Aceros de construcción generales								
 <b>Automatenstähle</b> Free cutting steels Aceros de corte fácil								
 <b>Unlegierte Vergütungsstähle</b> Unalloyed heat treatable steels Aceros para bonifi car no aleados								
 <b>Legierte Vergütungsstähle</b> Alloyed heat treatable steels Aceros para bonifi car aleados								
 <b>Rostfreie Stähle</b> Stainless steels Aceros inoxidables								
 <b>Grauguss, Temperguss</b> Grey cast iron, malleable cast iron Hiero fundido gris, fundición maleable								
 <b>Kupfer, Messing</b> Copper, brass Cobre, latón								
 <b>Aluminium</b> Aluminio Aluminio								
 <b>Kunststoffe</b> Plastics Plásticos								

Übersicht

Overview

Resumen

90°	90°							
HSS-Co5	HSS	HSS	HSS-Co5	HSS-Co5	HSS	HSS-Co5	HSS-Co5	HSS
				TiN			TiN	TiN
10,00 - 35,00	6,30 - 20,50	4,00 - 37,00	4,00 - 37,00	6,00 - 37,00	3,00 - 61,00	3,5 - 30,00	3,5 - 30,00	6,00 - 8,00
2291	720	722	726	728	721	723	725	721
301	302	303	303	303	305	305	305	307



Gewinde-, Senk- und Schälwerkzeuge  
Taps, dies, countersinks and conecut  
herramientas para roscar, avellanar y escarpar

**1 HSS Cobalt Handgewindebohrer-Satz, gerade genutet, für metrisches ISO-Gewinde DIN 13**

**Einsatzbereich:**

Für Durchgangs- und Grundgewinde, besonders geeignet für rost- und säurebeständige Stähle sowie legierte und unlegierte Stähle bis ca. 1.000 N/mm<sup>2</sup>, Stahlguss, Temperguss, Messing, Aluminium und Kupfer.

**E HSS Cobalt hand taps set, straight fluted, for metric ISO-threads DIN 13**

**Range of application:**

For through hole and blind hole threads, especially suitable for stainless and acid-resistant steels as well as alloyed and unalloyed steels up to appr. 1.000 N/mm<sup>2</sup>, cast steels, malleable cast iron, brass, aluminium and copper.

**ES Juego de machos para roscar manualmente HSS Cobalt, con ranura recta, para rosca ISO métrica DIN 13**

**Ámbito de aplicación:**

Para roscas pasantes y roscas ciegas, especialmente adecuada para aceros aleados y no aleados hasta aprox. 1000 N/mm<sup>2</sup>, así como fundición de acero, fundición maleable, latón, aluminio y cobre.



Industriequalität  
Industrial quality  
Calidad industrial



Präzise  
Precise  
Preciso



Verschleißfest  
Wear-resistant  
Resistente al desgaste

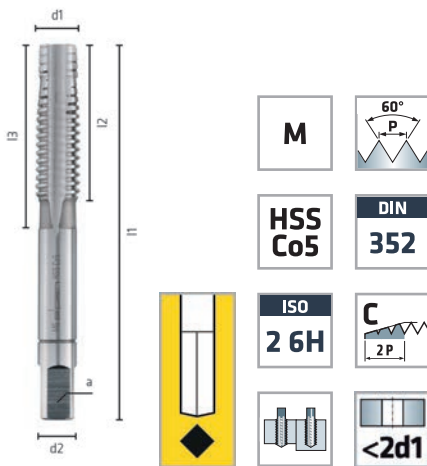

Einzelverpackung  
Single pack  
Embalaje individual

d1 mm	P mm	l1 mm	l2 mm	a <sub>h12</sub> mm		Code 717 Art.-Nr.	Inh. Cont.
M 3	0,5	40	12	2,7	Ø 2,5 mm	0071700300100	3
M 4	0,7	45	14	3,4	Ø 3,3 mm	0071700400100	3
M 5	0,8	50	16	4,9	Ø 4,2 mm	0071700500100	3
M 6	1	50	18	4,9	Ø 5 mm	0071700600100	3
M 8	1,25	56	18	4,9	Ø 6,8 mm	0071700800100	3
M 10	1,5	70	23	5,5	Ø 8,5 mm	0071701000100	3

\* Satz bestehend aus je 1 Stk. Vor-, Mittel- und Fertigschneider

\* Set consisting 1 pc. each pilot, middle and finishing cutter

\* Juego compuesto por 1 unid. de precortador, macho intermedio y macho acabador



**D HSS Handgewindebohrer-Satz, gerade genutet, für metrisches ISO-Gewinde DIN 13**

**Einsatzbereich:**

Für Durchgangs- und Grundgewinde, geeignet für legierte und unlegierte Stähle bis ca. 850 N/mm<sup>2</sup>, Stahlguss, Temperguss, Messing, Aluminium und Kupfer.

**E HSS hand taps set, straight fluted, for metric ISO-threads DIN 13**

**Range of application:**

For through hole and blind hole threads, suitable for alloyed and unalloyed steels up to appr. 850 N/mm<sup>2</sup>, cast steels, malleable cast iron, brass, aluminium and copper.

**ES Juego de machos para roscar manualmente HSS, con ranura recta, para rosca ISO métrica DIN 13**

**Ámbito de aplicación:**

Para roscas pasantes y roscas ciegas, adecuada para aceros aleados y no aleados hasta aprox. 850 N/mm<sup>2</sup>, así como fundición de acero, fundición maleable, latón, aluminio y cobre.



Präzise  
Precise  
Preciso



Verschleissfest  
Wear-resistant  
Resistente al desgaste

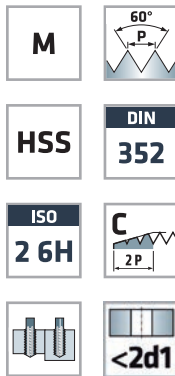
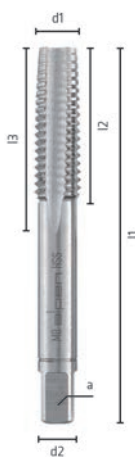

Einzelverpackung  
Single pack  
Embalaje individual

d1 mm	P mm	l1 mm	l2 mm	a <sub>h12</sub> mm		Code 707 Art.-Nr.	Inh. Cont.
M 2	0,4	36	8	2,1	Ø 1,6 mm	0070700200100	3
M 3	0,5	40	11	2,7	Ø 2,5 mm	0070700300100	3
M 4	0,7	45	13	3,4	Ø 3,3 mm	0070700400100	3
M 5	0,8	50	16	4,9	Ø 4,2 mm	0070700500100	3
M 6	1	50	19	4,9	Ø 5 mm	0070700600100	3
M 8	1,25	56	22	4,9	Ø 6,8 mm	0070700800100	3
M 10	1,5	70	24	5,5	Ø 8,5 mm	0070701000100	3
M 12	1,75	75	29	7	Ø 10,2 mm	0070701200100	3



Gewinde-, Senk- und Schälwerkzeuge  
Taps, dies, countersinks and conecut  
herramientas para roscar, avellanar y escarpar

\* Satz bestehend aus je 1 Stk. Vor-, Mittel- und Fertigschneider

\* Set consisting 1 pc. each pilot, middle and finishing cutter

\* Juego compuesto por 1 unid. de precortador, macho intermedio y macho acabador



**① HSS Handgewindebohrer-Satz, gerade genutet, für Whitworth-Rohrgewinde DIN ISO 228**

**Einsatzbereich:**

Für Durchgangs- und Grundgewinde, geeignet für legierte und unlegierte Stähle bis ca. 850 N/mm<sup>2</sup>, Stahlguss, Temperguss, Messing, Aluminium und Kupfer.

**② HSS hand taps set, straight fluted, for Whitworth pipe threads DIN ISO 228**

**Range of application:**

For through hole and blind hole threads, suitable for alloyed and unalloyed steels up to appr. 850 N/mm<sup>2</sup>, cast steels, malleable cast iron, brass, aluminium and copper.

**③ Juego de machos para roscar manualmente HSS, con ranura recta, para rosca para tubos Whitworth DIN ISO 228**

**Ámbito de aplicación:**

Para roscas pasantes y roscas ciegas, adecuada para aceros aleados y no aleados hasta aprox. 850 N/mm<sup>2</sup>, así como fundición de acero, fundición maleable, latón, aluminio y cobre.



Präzise  
Precise  
Preciso



Verschleissfest  
Wear-resistant  
Resistente al desgaste

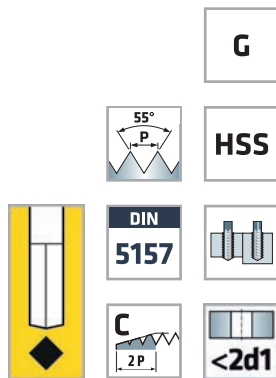

Einzelverpackung  
Single pack  
Embalaje individual

d1 mm	P mm	l1 mm	l2 mm	a <sub>h12</sub> mm		Code 706 Art.-Nr.	Inh. Cont.
G 1/8"	28	63	20	5,5	Ø 8,8 mm	0070601600100	2
G 1/4"	19	70	22	9	Ø 11,8 mm	0070602000100	2
G 3/8"	19	70	22	9	Ø 15,25 mm	0070602400100	2
G 1/2"	14	80	22	12	Ø 19 mm	0070602800100	2

\* Satz bestehend aus je 1 Stk. Vor- und Fertigschneider

\* Set consisting 1 pc. each pilot and finishing cutter

\* Juego compuesto por 1 unid. de precortador y macho acabador



**D** HSS Einschnitt-Gewindebohrer, gerade genutet, für metrisches ISO-Gewinde DIN 13

**Einsatzbereich:**

Für Durchgangsgewinde, geeignet für legierte und unlegierte Stähle bis ca. 850 N/mm<sup>2</sup>, Stahlguss, Temperguss, Messing, Aluminium und Kupfer.



Präzise  
Precise  
Preciso



Verschleissfest  
Wear-resistant  
Resistente al desgaste

**E** HSS single cut taps, straight fluted, for metric ISO-threads DIN 13

**Range of application:**

For through hole threads, suitable for alloyed and unalloyed steels up to appr. 850 N/mm<sup>2</sup>, cast steels, malleable cast iron, brass, aluminium and copper.

**ES** Macho de corte HSS, con ranura recta, para rosca ISO métrica DIN 13

**Ámbito de aplicación:**

Para roscas pasantes, adecuada para aceros aleados y no aleados hasta aprox. 850 N/mm<sup>2</sup>, así como fundición de acero, fundición maleable, latón, aluminio y cobre.

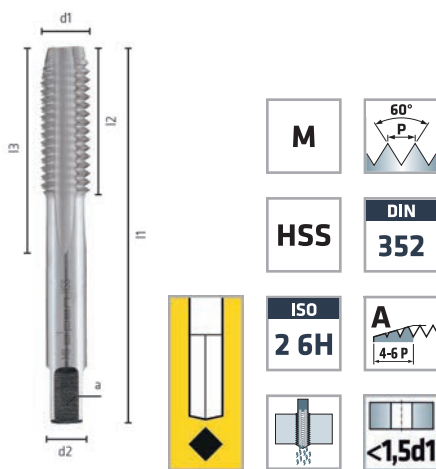

Einzelverpackung  
Single pack  
Embalaje individual

d1 mm	P mm	l1 mm	l2 mm	a <sub>h12</sub> mm		Code 708 Art.-Nr.	Inh. Cont.
M 2	0,4	36	8	2,1	Ø 1,6 mm	0070800200100	1
M 3	0,5	40	11	2,7	Ø 2,5 mm	0070800300100	1
M 4	0,7	45	13	3,4	Ø 3,3 mm	0070800400100	1
M 5	0,8	48	16	4,9	Ø 4,2 mm	0070800500100	1
M 6	1	50	19	4,9	Ø 5 mm	0070800600100	1
M 8	1,25	56	22	4,9	Ø 6,8 mm	0070800800100	1
M 10	1,5	70	24	5,5	Ø 8,5 mm	0070801000100	1
M 12	1,75	75	29	7	Ø 10,2 mm	0070801200100	1

HSS-G Gewindebohrersatz, 16-tlg., Einschnittgewindebohrer



16-tlg. / 16-pcs. / 16-unid.  
Kunststoffkassette / Plastic cassette / Caja de plástico  
Art.-Nr. 0070800016100

Inhalt Contents / Contenido	Stk. <sup>(1)</sup> pc. <sup>(1)</sup>
Einschnitt-Gewindebohrer Single cut taps / Machos de corte, M3-M12	1
Schneideisen / Dies / Terrajas, M3-M12	1
Schneideisenhalter / Die stocks / Portaterrijas, Nr. 4	1
Windeisen / Tap wrenches / Giramachos Nr. 1 1/2	1

<sup>(1)</sup> Stück je Abmessung / Pieces each dimension / Piezas por diámetro



Gewinde-, Senk- und Schälwerkzeuge  
Taps, dies, countersinks and conecut  
herramientas para roscar, avellanar y escarpar

① Windeisen, Werkzeughalter und Schraubenausdrehersatz

② Tap wrenches, tool holder and screw-remover set

③ Giramachos, portaherramientas y juego de extractores de tornillos



Einzelverpackung  
Single pack  
Embalaje individual



Windeisen Nr. 11/2 Tap wrenches Giramachos	l1 mm	Code 712 Art.-Nr.	Inh. Cont.
M2 - M12	180	0071200015100	1
Windeisen Nr. 3 Tap wrenches Giramachos	l1 mm	Code 5430 Art.-Nr.	Inh. Cont.
G 1/8" - G 1/2"	380	0543000030100	1
Werkzeughalter mit Knarre Tool holder with ratchet Portaherramientas con trinquete	l1 mm	Code 713 Art.-Nr.	Inh. Cont.
M3 - M10, Größe 1 / Size 1 / Tamaño 1	85	0071300001100	1
M5 - M12, Größe 2 / Size 2 / Tamaño 2	100	0071300002100	1
Schraubenausdrehersatz Screw-remover set Juego de extractores de tornillos		Code 902 Art.-Nr.	Inh. Cont.
M3 - M18, 5-tlg. / 5 pcs / 5 unid.		0000902002100	5
Schraubenausdreher Screw-remover Juego de extractores de tornillos	l1 mm	Code 701 Art.-Nr.	Inh. Cont.
Größe 1 / Size 1 / Tamaño 1	60	0070100001100	1
Größe 2 / Size 2 / Tamaño 2	68	0070100002100	1
Größe 3 / Size 3 / Tamaño 3	75	0070100003100	1
Größe 4 / Size 4 / Tamaño 4	82	0070100004100	1
Größe 5 / Size 5 / Tamaño 5	90	0070100005100	1

Schraubenausdrehersatz BOX 5



5-tlg. / 5-pcs. / 5-unid.  
Kunststoffbox / Plastic box / Caja de plástico  
Art.-Nr. 0000902003100

Ø mm	Stk. <sup>(1)</sup> pc. <sup>(1)</sup>
Schraubenausdrehersatz	
Ø M5-M20	1

<sup>(1)</sup> Stück je Abmessung  
<sup>(1)</sup> Pieces each dimension  
<sup>(1)</sup> Piezas por diámetro



**D** HSS Schneideisen für metrisches ISO-Gewinde DIN 13

**Einsatzbereich:**

Geeignet für legierte und unlegierte Stähle bis ca. 850 N/mm<sup>2</sup>.

**E** HSS dies for metric ISO-threads DIN 13

**Range of application:**

Suitable for alloyed and unalloyed steels up to appr. 850 N/mm<sup>2</sup>.

**ES** Terrajas HSS para rosca ISO métrica, DIN 13

**Ámbito de aplicación:**

Adecuada para aceros aleados y no aleados con una resistencia a la extensión de 850 N/mm<sup>2</sup>.



Präzise  
Precise  
Preciso



Verschleissfest  
Wear-resistant  
Resistente al desgaste

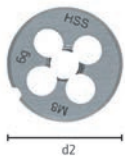
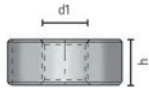

M

HSS

WN

ISO  
6g

SB-Aufhänger  
Plastic tag  
Gancho para autoservicio



Einzelverpackung  
Single pack  
Embalaje individual

d1 mm	P mm	d2 mm	h mm	Code 710 Art.-Nr.	Inh. Cont.
M 2	0,4	25,00	9	0071000200100	1
M 3	0,5	25,00	9	0071000300100	1
M 4	0,7	25,00	9	0071000400100	1
M 5	0,8	25,00	9	0071000500100	1
M 6	1	25,00	9	0071000600100	1
M 8	1,25	25,00	9	0071000800100	1
M 10	1,5	25,00	9	0071001000100	1
M 12	1,75	25,00	9	0071001200100	1



Gewinde-, Senk- und Schälwerkzeuge  
Taps, dies, countersinks and conecut  
herramientas para roscar, avellanar y escarpar

① **Schneideisenhalter für runde Schneideisen DIN 223**

② **Die stocks for round dies DIN 223**

③ **Portaterrajás para terrajas redondas DIN 223**



**DIN EN 22568**

SB-Aufhänger  
Plastic tag  
Gancho para autoservicio



Einzelverpackung  
Single pack  
Embalaje individual

Nr. N.º	d2 mm	h mm			Code 711 Art.-Nr.	Inh. Cont.
4	25,00	9	M8	M2-M12 (Code 710)	0071102509100	1

HSS-G Gewindebohrersatz

HSS-G DIN Gewindebohrersatz



16-tlg. / 16-pcs. / 16-unid.  
Kunststoffkassette / Plastic cassette / Caja de plástico  
Art.-Nr. 0070800016100

37-tlg. / 37-pcs. / 37-unid.  
Stahlblechkassette / Metal cassette / Caja de metal  
Art.-Nr. 0070800031100

Inhalt Contents / Contenido	Stk. <sup>(1)</sup> pc. <sup>(1)</sup>	Inhalt Contents / Contenido	Stk. <sup>(1)</sup> pc. <sup>(1)</sup>
Einschnitt-Gewindebohrer / Single cut taps / Machos de corte, M3-M12	1	Gewindebohrer / Taps / Machos para roscar M3-M12	1
Schneideisen / Dies / Terrajas, M3-M12	1	Schneideisen / Dies / Terrajas, M3-M12	1
Schneideisenhalter / Die stocks / Portaterrajás, Nr. 4	1	Schneideisenhalter / Die stocks / Portaterrajás, Nr. 2, 3, 4, 5, 7	1
Windeisen / Tap wrenches / Giramachos Nr. 1 ½	1	Windeisen / Tap wrenches / Giramachos Nr. 1, 2	1
		Schraubendreher / Screwdriver / Destornillador	1
		Gewindelehre / Gauge / Calibrador de roscas	1

d2 = Angaben von Schneideisen  
d2 = Data of dies  
d2 = Datos de las terrajas

<sup>(1)</sup> Stück je Abmessung  
<sup>(1)</sup> Pieces each dimension  
<sup>(1)</sup> Piezas por diámetro

**D** HSS Cobalt Maschinengewindebohrer, gerade genutet, für metrisches ISO-Gewinde DIN 13

**Einsatzbereich:**

Für Durchgangsgewinde, besonders geeignet für rost- und säurebeständige Stähle sowie legierte und unlegierte Stähle bis ca. 1.000 N/mm<sup>2</sup>.

**E** HSS Cobalt machine taps, straight fluted, for metric ISO-threads DIN 13

**Range of application:**

For through hole threads, especially suitable for stainless and acid-resistant steels as well as alloyed and unalloyed steels up to appr. 1.000 N/mm<sup>2</sup>.

**ES** Macho para roscar a máquina HSS Cobalt, con ranura recta, para rosca ISO métrica, DIN 13

**Ámbito de aplicación:**

Para roscas pasantes, especialmente adecuada para aceros resistentes a los ácidos y la corrosión, así como para aceros aleados y no aleados hasta aprox. 1000 N/mm<sup>2</sup>.



Industriequalität  
Industrial quality  
Calidad industrial



Präzise  
Precise  
Preciso



Verschleißfest  
Wear-resistant  
Resistente al desgaste

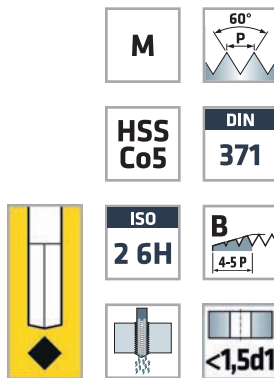

Einzelverpackung  
Single pack  
Embalaje individual

d1 mm	P mm	l1 mm	l2 mm	a <sub>h12</sub> mm		Code 704 Art.-Nr.	Inh. Cont.
M 3	0,5	56	11	2,7	Ø 2,5 mm	0070400300100	1
M 4	0,7	63	13	3,4	Ø 3,3 mm	0070400400100	1
M 5	0,8	70	16	4,9	Ø 4,2 mm	0070400500100	1
M 6	1	80	19	4,9	Ø 5 mm	0070400600100	1
M 8	1,25	90	22	6,2	Ø 6,8 mm	0070400800100	1
M 10	1,5	100	24	8	Ø 8,5 mm	0070401000100	1
M 12	1,75	110	29	7	Ø 10,2 mm	0070401200100	1

HSS-E DIN Maschinengewindebohrersatz KM 14

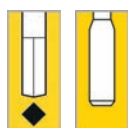

14-tlg. / 14-pcs. / 14-unid.  
Metallkassette / Metal cassette / Caja de metal  
Art.-Nr. 0070800014100

Ø mm	Stk. <sup>(1)</sup> pc. <sup>(1)</sup>
HSS Cobalt	
Ø 2,50 / 3,30 / 4,20 / 5,00 / 6,80 / 8,50 / 10,20	1
Ø M3-M12	1

M3 - M10 = DIN 371 / M12 = DIN 376

<sup>(1)</sup> Stück je Abmessung / Pieces each dimension / Piezas por diámetro



Gewinde-, Senk- und Schälwerkzeuge  
Taps, dies, countersinks and conecut  
herramientas para roscar, avellanar y escarpar

**1** HSS Cobalt Maschinengewindebohrer, spiral-genutet, für metrisches ISO-Gewinde DIN 13

**Einsatzbereich:**

Für Grundgewinde, besonders geeignet für rost- und säurebeständige Stähle sowie legierte und unlegierte Stähle bis ca. 1.000 N/mm<sup>2</sup>.

**E** HSS Cobalt machine taps, spiral fluted, for metric ISO-threads DIN 13

**Range of application:**

For blind hole threads, especially suitable for stainless and acid-resistant steels as well as alloyed and unalloyed steels up to appr. 1.000 N/mm<sup>2</sup>.

**ES** Macho para roscar a máquina HSS Cobalt, con ranura en espiral, para rosca ISO métrica, DIN 13

**Ámbito de aplicación:**

Para roscas ciegas, especialmente adecuada para aceros resistentes a los ácidos y la corrosión, así como para aceros aleados y no aleados hasta aprox. 1000 N/mm<sup>2</sup>.



Industriequalität  
Industrial quality  
Calidad industrial



Präzise  
Precise  
Preciso



Verschleissfest  
Wear-resistant  
Resistente al desgaste

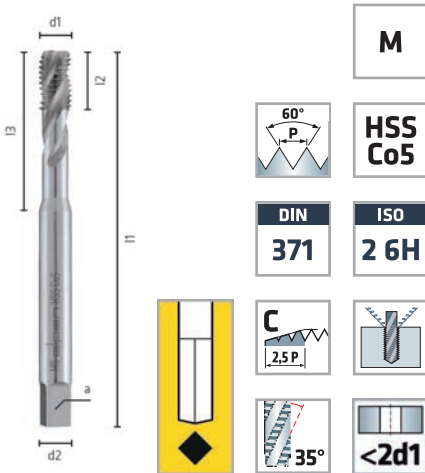

Einzelverpackung  
Single pack  
Embalaje individual

d1 mm	P mm	l1 mm	l2 mm	a <sub>h12</sub> mm		Code 714 Art.-Nr.	Inh. Cont.
M 3	0,5	56	6	2,7	Ø 2,5 mm	0071400300100	1
M 4	0,7	63	7	3,4	Ø 3,3 mm	0071400400100	1
M 5	0,8	70	8	4,9	Ø 4,2 mm	0071400500100	1
M 6	1	80	10	4,9	Ø 5 mm	0071400600100	1
M 8	1,25	90	14	6,2	Ø 6,8 mm	0071400800100	1
M 10	1,5	100	16	8	Ø 8,5 mm	0071401000100	1
M 12	1,75	110	18	7	Ø 10,2 mm	0071401200100	1

M3 - M10 = DIN 371 / M12 = DIN 376

**D** HSS Maschinengewindebohrer, gerade genutet, für metrisches ISO-Gewinde DIN 13

**Einsatzbereich:**

Maschinengewindebohrer mit Schälanschnitt für Durchgangsgewinde, geeignet für legierte und unlegierte Stähle bis ca. 850 N/mm<sup>2</sup>, Temperguss, Sphäroguss, Zinklegierungen, Zinkdruckguss sowie Messing (langspanend).



Präzise  
Precise  
Preciso



Verschleissfest  
Wear-resistant  
Resistente al desgaste

**E** HSS machine taps, straight fluted, for metric ISO-threads DIN 13

**Range of application:**

Machine taps with spiral point for through hole threads, suitable for alloyed and unalloyed steels up to appr. 850 N/mm<sup>2</sup>, malleable cast iron, spheroidal graphite, zinc alloys, zinc die castings as well as brass (long chipping).

**ES** Macho para roscar a máquina HSS, con ranura recta, para rosca ISO métrica, DIN 13

**Ámbito de aplicación:**

Macho para roscar a máquina con corte inicial helicoidal para roscas pasantes, adecuada para aceros aleados y no aleados hasta aprox. 850 N/mm<sup>2</sup>, así como fundición maleable, fundición nodular, aleaciones de cinc, cinc moldeado a presión y latón (de viruta larga).

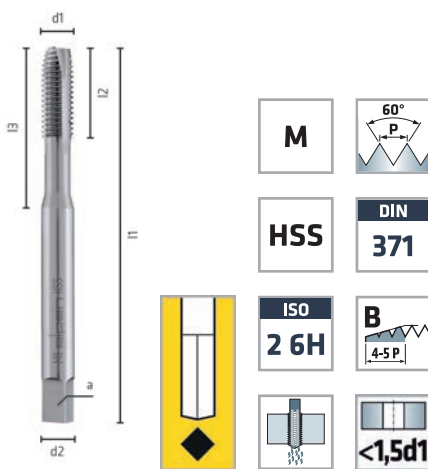

Einzelverpackung  
Single pack  
Embalaje individual

d1 mm	P mm	l1 mm	l2 mm	a <sub>h12</sub> mm		Code 709 Art.-Nr.	Inh. Cont.
M 3	0,5	56	11	2,7	Ø 2,5 mm	0070900300100	1
M 4	0,7	63	13	3,4	Ø 3,3 mm	0070900400100	1
M 5	0,8	70	16	4,9	Ø 4,2 mm	0070900500100	1
M 6	1	80	19	4,9	Ø 5 mm	0070900600100	1
M 8	1,25	90	22	6,2	Ø 6,8 mm	0070900800100	1
M 10	1,5	100	24	8	Ø 8,5 mm	0070901000100	1
M 12	1,75	110	29	7	Ø 10,2 mm	0070901200100	1

M3 - M10 = DIN 371 / M12 = DIN 376



Gewinde-, Senk- und Schälwerkzeuge  
Taps, dies, countersinks and conecut  
herramientas para roscar, avellanar y escarpar

**① HSS Maschinengewindebohrer, spiral-genutet, für metrisches ISO-Gewinde DIN 13**

**Einsatzbereich:**

Für Grundgewinde, geeignet für legierte und unlegierte Stähle bis ca. 850 N/mm<sup>2</sup>, Temperguss, Sphäroguss, Zinklegierungen, Zinkdruckguss sowie Messing (langspanend).

**② HSS machine taps, spiral fluted, for metric ISO-threads DIN 13**

**Range of application:**

For blind hole threads, suitable for alloyed and unalloyed steels up to appr. 850 N/mm<sup>2</sup>, malleable cast iron, spheroidal graphite, zinc alloys, zinc die castings as well as brass (long chipping).

**③ Macho para roscar a máquina HSS, con ranura en espiral, para rosca ISO métrica, DIN 13**

**Ámbito de aplicación:**

Para roscas ciegas, adecuada para aceros aleados y no aleados hasta aprox. 850 N/mm<sup>2</sup>, así como fundición maleable, fundición nodular, aleaciones de cinc, cinc moldeado a presión y latón (de viruta larga).



Präzise  
Precise  
Preciso



Verschleissfest  
Wear-resistant  
Resistente al desgaste

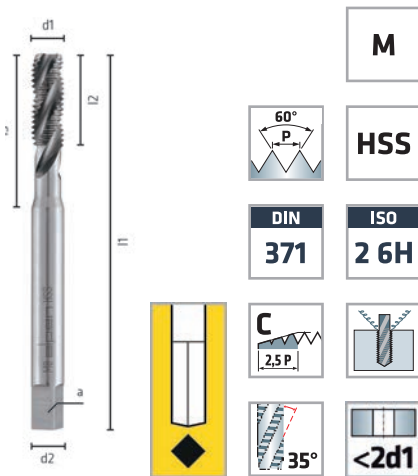

M  
HSS  
DIN 371  
ISO 2 6H  
C 2.5 P  
35°  
<2d1



Einzelverpackung  
Single pack  
Embalaje individual

d1 mm	P mm	l1 mm	l2 mm	a <sub>h12</sub> mm		Code 719 Art.-Nr.	Inh. Cont.
M 3	0,5	56	6	2,7	Ø 2,5 mm	0071900300100	1
M 4	0,7	63	7	3,4	Ø 3,3 mm	0071900400100	1
M 5	0,8	70	8	4,9	Ø 4,2 mm	0071900500100	1
M 6	1	80	10	4,9	Ø 5 mm	0071900600100	1
M 8	1,25	90	14	6,2	Ø 6,8 mm	0071900800100	1
M 10	1,5	100	16	8	Ø 8,5 mm	0071901000100	1
M 12	1,75	110	18	7	Ø 10,2 mm	0071901200100	1

M3 - M10 = DIN 371 / M12 = DIN 376

**D HSS Einschnittgewindebohrer mit 1/4"-Sechskantschaft für metrisches ISO-Gewinde DIN 13**

**Einsatzbereich:**

Für Durchgangsgewinde, geeignet für legierte und unlegierte Stähle bis ca. 850 N/mm<sup>2</sup>, Stahlguss, Temperguss, Messing, Aluminium und Kupfer.

**E HSS single cut taps with 1/4" hexagonal shank for metric ISO-threads DIN 13**

**Range of application:**

For through hole threads, suitable for alloyed and unalloyed steels up to appr. 850 N/mm<sup>2</sup>, cast steels, malleable cast iron, brass, aluminium and copper.

**ES Machos de corte HSS con eje hexagonal 1/4" para roscas ISO métricas DIN 13**

**Ámbito de aplicación:**

Para roscas pasantes, adecuada para aceros aleados y no aleados hasta aprox. 850 N/mm<sup>2</sup>, así como fundición de acero, fundición maleable, latón, aluminio y cobre.



Präzise  
Precise  
Preciso



Verschleissfest  
Wear-resistant  
Resistente al desgaste

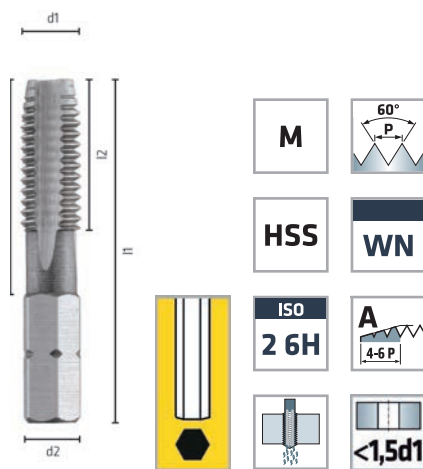

Einzelverpackung  
Single pack  
Embalaje individual

d1 mm	P mm	l1 mm	l2 mm		Code 702 Art.-Nr.	Inh. Cont.
M 3	0,5	33	11	Ø 2,5 mm	0070200300100	1
M 4	0,7	35	12	Ø 3,3 mm	0070200400100	1
M 5	0,8	36	15	Ø 4,2 mm	0070200500100	1
M 6	1	39	18	Ø 5 mm	0070200600100	1
M 8	1,25	40	19	Ø 6,8 mm	0070200800100	1
M 10	1,5	41	21	Ø 8,5 mm	0070201000100	1



Gewinde-, Senk- und Schälwerkzeuge  
Taps, dies, countersinks and conecut  
herramientas para roscar, avellanar y escarpar

① HSS Kombigewindebohrer mit 1/4"-Sechskantschaft für metrisches ISO-Gewinde DIN 13

**Einsatzbereich:**

Zum Bohren, Gewindeschneiden und Senken. Für Durchgangsgewinde, geeignet für legierte und unlegierte Stähle bis ca. 850 N/mm<sup>2</sup>.

② HSS combination taps with 1/4" hexagonal shank for metric ISO-threads DIN 13

**Range of application:**

For drilling, tapping and countersinking. For through hole threads, suitable for alloyed and unalloyed steels up to approx. 850 N/mm<sup>2</sup>.

③ Machos para roscar combinados HSS con eje hexagonal 1/4" para roscas ISO métricas DIN 13

**Ámbito de aplicación:**

Para taladrar, roscar y avellanar. Para roscas pasantes, adecuada para aceros aleados y no aleados hasta aprox. 850 N/mm<sup>2</sup>.



Verschleissfest  
Wear-resistant  
Resistente al desgaste



Präzise  
Precise  
Preciso

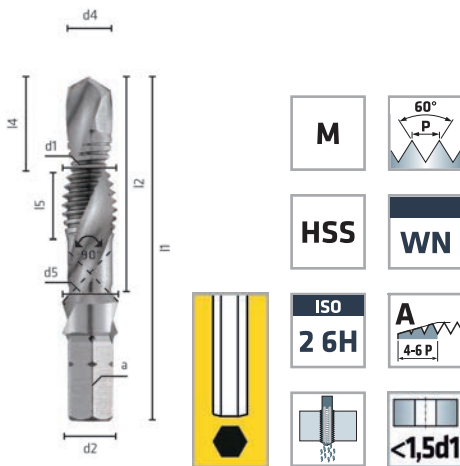

Einzelverpackung  
Single pack  
Embalaje individual

d1 mm	P mm	l1 mm	l2 mm		Code 703 Art.-Nr.	Inh. Cont.
M 3	0,5	36	24	Ø 2,5 mm	0070300300100	1
M 4	0,7	39	27	Ø 3,3 mm	0070300400100	1
M 5	0,8	41	29	Ø 4,2 mm	0070300500100	1
M 6	1	44	32	Ø 5 mm	0070300600100	1
M 8	1,25	50	38	Ø 6,8 mm	0070300800100	1
M 10	1,5	59	47	Ø 8,5 mm	0070301000100	1

Schaft nach DIN 3126, Form C6.3, ISO 1173  
Shank DIN 3126, Form C6.3, ISO 1173  
Eje según DIN 3126, forma C6.3, ISO 1173



### HSS Cobalt Kegelsenker ungleiche Teilung DIN 334 C, 60°

### E HSS Cobalt countersinks different partition DIN 334 C, 60°

### ES Avellanador cónico HSS Cobalto, división irregular, DIN 334 C, 60°

**Einsatzbereich:**

**Einsatzbereich:**

Für alle E- und NE-Metalle, Kunststoffe hart und weich. Universell einsetzbares Entgrat- und Senkwerkzeug für Bohrungen aller Art. Sehr gute Schneideigenschaften durch ungleichgeteilte Schneiden.

**Range of application:**

For ferrous and non-ferrous metals, synthetic materials soft and hard. Universal deburring and sink tool for all kind of borings. Excellent cutting features guarantee a smooth surface by unequally divided cutting edges. Reduction of feed force and chatter marks on the countersinking surface due to reduced axial and radial force.

**Ámbito de aplicación:**

Para todos los metales E y NE y plásticos duros y blandos. Herramienta para desbarbar y avellanar de aplicación universal para agujeros de todo tipo. Excelentes características de corte, por corte desigual dividida.



Hitzebeständig  
Heat resistant  
Termoestable



Präzise  
Precise  
Preciso



Industriequalität  
Industrial quality  
Calidad industrial

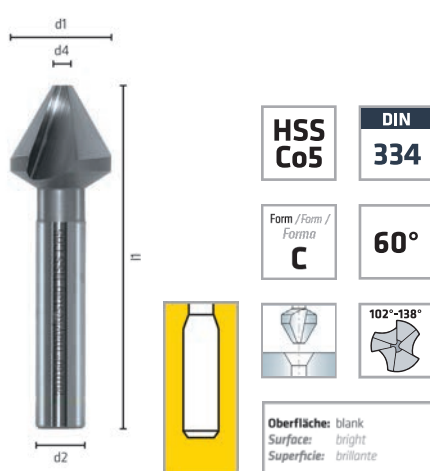

Einzelverpackung mit Aufhänger  
Single pack with tag  
Embalaje individual con gancho para autoservicio

d1 mm	d4 mm		d2 <sub>h9</sub> mm	l1 mm	Z	Code 2270 Art.-Nr.	Inh. Cont.
6,30	1,60	M 3	5,00	45	3	0227000630100	1
8,00	2,00	M 4	6,00	50	3	0227000800100	1
10,00	2,50	M 5	6,00	50	3	0227001000100	1
12,50	3,20	M 6	8,00	56	3	0227001250100	1
16,00	4,00	M 8	10,00	63	3	0227001600100	1
20,00	5,00	M 10	10,00	67	3	0227002000100	1
25,00	6,30	M 12	10,00	71	3	0227002500100	1



Gewinde-, Senk- und Schälwerkzeuge  
Taps, dies, countersinks and conecut  
herramientas para roscar, avellanar y escarpar

① HSS Cobalt Kegelsenker, ungleiche Teilung DIN 335 C, 90°

② HSS Cobalt countersinks, different partition DIN 335 C, 90°

③ Avellanador cónico HSS Cobalto, división irregular, DIN 335 C, 90°

**Einsatzbereich:**

Für alle E- und NE-Metalle, Kunststoffe hart und weich. Universell einsetzbares Entgrat- und Senkwerkzeug für Bohrungen aller Art. Sehr gute Schneideigenschaften durch ungleichgeteilte Schneiden.

**Range of application:**

For ferrous and non-ferrous metals, synthetic materials soft and hard. Universal deburring and sink tool for all kind of borings. Excellent cutting features guarantee a smooth surface by unequally divided cutting edges. Reduction of feed force and chatter marks on the countersinking surface due to reduced axial and radial force.

**Ámbito de aplicación:**

Para todos los metales E y NE y plásticos duros y blandos. Herramienta para desbarbar y avellanar de aplicación universal para agujeros de todo tipo. Excelentes características de corte, por corte desigual dividida.



Hitzebeständig  
Heat resistant  
Termoestable



Präzise  
Precise  
Preciso



Industriequalität  
Industrial quality  
Calidad industrial



Einzelverpackung mit Aufhänger  
Single pack with tag  
Embalaje individual con gancho para autoservicio



**ALUNIT®**  
Höhere Performance,  
längere Standzeit  
Higher performance,  
longer durability  
Rendimiento superior  
tiempo de uso más  
prolongado





Einzelverpackung mit Aufhänger  
Single pack with tag  
Embalaje individual con gancho para autoservicio

							blank / bright / brillante	ALUNIT®	
d1	d4		d2 <sub>h9</sub>	l1	Z	Code 2390	Inh.	Code 2397	Inh.
mm	mm		mm	mm		Art.-Nr.	Cont.	Art.-Nr.	Cont.
6,30	1,50	M 3	5,00	45	3	0239000630100	1	0239700630100	1
8,30	2,00	M 4	6,00	50	3	0239000830100	1	0239700830100	1
10,40	2,50	M 5	6,00	50	3	0239001040100	1	0239701040100	1
12,40	2,80	M 6	8,00	56	3	0239001240100	1	0239701240100	1
16,50	3,20	M 8	10,00	60	3	0239001650100	1	0239701650100	1
20,50	3,50	M 10	10,00	63	3	0239002050100	1	0239702050100	1
25,00	3,80	M 12	10,00	67	3	0239002500100	1	0239702500100	1
31,00	4,20		12,00	71	3	0239003100100	1	0239703100100	1

**D** Kassetten, Sets

**E** Cassettes, sets

**ES** Cajas, juegos

<p>HSS Cobalt Kegelsenker-Satz KM 4</p>  <p>4-tlg. / 4-pcs. / 4-unid. Metallkassette / Metal cassette / Caja de metal Art.-Nr. 023900004100</p>		<p>HSS Cobalt Kegelsenker-Satz KP 5</p>  <p>5-tlg. / 5-pcs. / 5-unid. Kunststoffkassette / Plastic cassette / Caja de plástico Art.-Nr. 023900005100</p>		<p>HSS Cobalt Kegelsenker-Satz KM 4</p>  <p>4-tlg. / 4-pcs. / 4-unid. Metallkassette / Metal cassette / Caja de metal Art.-Nr. 023970004100</p>	
Ø mm	Stk. <sup>(1)</sup> pc. <sup>(1)</sup>	Ø mm	Stk. <sup>(1)</sup> pc. <sup>(1)</sup>	Ø mm	Stk. <sup>(1)</sup> pc. <sup>(1)</sup>
MAYKESTAG		MAYKESTAG		MAYKESTAG	
Ø 10,40 / 16,50 / 20,50 / 25,00	1	Ø 6,30 / 10,40 / 16,50 / 20,50 / 25,00	1	Ø 10,40 / 16,50 / 20,50 / 25,00	1
<p>HSS Cobalt Kegelsenker-Satz KP 5</p>  <p>5-tlg. / 5-pcs. / 5-unid. Kunststoffkassette / Plastic cassette / Caja de plástico Art.-Nr. 023970005100</p>		<p>Hartmetall-Set Frässtifte/Senker BOX 5</p>  <p>5-tlg. / 5-pcs. / 5-unid. Kunststoffbox / Plastic box / Caja de plástico Art.-Nr. 077600002100</p>			
Ø mm	Stk. <sup>(1)</sup> pc. <sup>(1)</sup>	Ø mm	Stk. <sup>(1)</sup> pc. <sup>(1)</sup>		
MAYKESTAG		HM-Frässtift			
Ø 6,30 / 10,40 / 16,50 / 20,50 / 25,00	1	Ø 10x65, ZYA-S	1		
		Ø 10x65, WRC	1		
		Ø 10x65, SPG	1		
		MAYKESTAG			
		HSS Cobalt Kegelsenker Ø 10,40 / 12,40	1		



Gewinde-, Senk- und Schälwerkzeuge  
Taps, dies, countersinks and conecut  
herramientas para roscar, avellanar y escarpar

<sup>(1)</sup> Stück je Abmessung / Pieces each dimension / Piezas por diámetro

**1** HSS Cobalt Kegelsenker, 3-Flächenschaft, ungleiche Teilung, DIN 335 C, 90°

**Einsatzbereich:**

Für alle E- und NE-Metalle, Kunststoffe hart und weich. Universell einsetzbares Entgrat- und Senkwerkzeug für Bohrungen aller Art. Sehr gute Schneideigenschaften durch ungleichgeteilte Schneiden.

**E** HSS Cobalt countersinks, 3-surface shank, different partition, DIN 335 C, 90°

**Range of application:**

For ferrous and non-ferrous metals, synthetic materials soft and hard. Universal deburring and sink tool for all kind of borings. Excellent cutting features guarantee a smooth surface by unequally divided cutting edges.

**ES** Avellanador cónico HSS Cobalto, eje de 3 caras, división irregular, DIN 335 C, 90°

**Ámbito de aplicación:**

Para todos los metales E y NE y plásticos duros y blandos. Herramienta para desbarbar y avellanar de aplicación universal para agujeros de todo tipo. Excelentes características de corte, por corte desigual dividida.



Hitzebeständig  
Heat resistant  
Termoestable



Präzise  
Precise  
Preciso



3-Flächenschaft  
3-surface shank  
3 caras

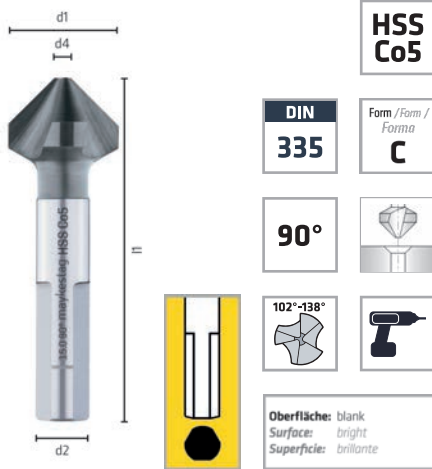

Einzelverpackung mit Aufhänger  
Single pack with tag  
Embalaje individual con gancho para autoservicio



**ALUNIT®**  
Höhere Performance,  
längere Standzeit  
Higher performance,  
longer durability  
Rendimiento superior  
tiempo de uso más  
prolongado









Einzelverpackung mit Aufhänger  
Single pack with tag  
Embalaje individual con gancho para autoservicio

blank / bright / brillante							ALUNIT®		
d1 mm	d4 mm		d2 <sub>h9</sub> mm	l1 mm	Z	Code 2380 Art.-Nr.	Inh. Cont.	Code 2387 Art.-Nr.	Inh. Cont.
6,30	1,50	M 3	5,00	45	3	0238000630100	1	0238700630100	1
8,30	2,00	M 4	6,00	50	3	0238000830100	1	0238700830100	1
10,40	2,50	M 5	6,00	50	3	0238001040100	1	0238701040100	1
12,40	2,80	M 6	8,00	56	3	0238001240100	1	0238701240100	1
16,50	3,20	M 8	10,00	60	3	0238001650100	1	0238701650100	1
20,50	3,50	M 10	10,00	63	3	0238002050100	1	0238702050100	1
25,00	3,80	M 12	10,00	67	3	0238002500100	1	0238702500100	1
31,00	4,20		12,00	71	3	0238003100100	1	0238703100100	1

D Kassetten, Sets

E Cassettes, sets

ES Cajas, juegos

<p>HSS Cobalt Kegelsenker-Satz KM 4</p>  		<p>HSS Cobalt Kegelsenker-Satz KP 5</p>  		<p>HSS Cobalt Kegelsenker-Satz KM 4</p>  	
<p>4-tlg. / 4-pcs. / 4-unid. Metallkassette / Metal cassette / Caja de metal Art.-Nr. 0238000004100</p>		<p>5-tlg. / 5-pcs. / 5-unid. Kunststoffkassette / Plastic cassette / Caja de plástico Art.-Nr. 0238000005100</p>		<p>4-tlg. / 4-pcs. / 4-unid. Metallkassette / Metal cassette / Caja de metal Art.-Nr. 0238700004100</p>	
<b>Ø</b>	<b>Stk. <sup>(1)</sup></b>	<b>Ø</b>	<b>Stk. <sup>(1)</sup></b>	<b>Ø</b>	<b>Stk. <sup>(1)</sup></b>
<b>mm</b>	<b>pc. <sup>(1)</sup></b>	<b>mm</b>	<b>pc. <sup>(1)</sup></b>	<b>mm</b>	<b>pc. <sup>(1)</sup></b>
MAYKESTAG		MAYKESTAG		MAYKESTAG	
Ø 10,40 / 16,50 / 20,50 / 25,00	1	Ø 6,30 / 10,40 / 16,50 / 20,50 / 25,00	1	Ø 10,40 / 16,50 / 20,50 / 25,00	1
<p>HSS Cobalt Kegelsenker-Satz KP 5</p>  					
<p>5-tlg. / 5-pcs. / 5-unid. Kunststoffkassette / Plastic cassette / Caja de plástico Art.-Nr. 0238700005100</p>					
<b>Ø</b>	<b>Stk. <sup>(1)</sup></b>				
<b>mm</b>	<b>pc. <sup>(1)</sup></b>				
MAYKESTAG					
Ø 6,30 / 10,40 / 16,50 / 20,50 / 25,00	1				



Gewinde-, Senk- und Schälwerkzeuge  
Taps, dies, countersinks and conecut  
herramientas para roscar, avellanar y escarpar

<sup>(1)</sup> Stück je Abmessung / Pieces each dimension / Piezas por diámetro

### HSS Cobalt Kegelsenker lang, ungleiche Teilung DIN 335 C, 90°

**Einsatzbereich:**

Für alle E- und NE-Metalle, Kunststoffe hart und weich. Universell einsetzbares Entgrat- und Senkwerkzeug für Bohrungen aller Art. Sehr gute Schneideigenschaften durch ungleichgeteilte Schneiden.



Hitzebeständig  
Heat resistant  
Termoestable



Präzise  
Precise  
Preciso



Industriequalität  
Industrial quality  
Calidad industrial

### E HSS Cobalt countersinks long series, different partition DIN 335 C, 90°

**Range of application:**

For ferrous and non-ferrous metals, synthetic materials soft and hard. Universal deburring and sink tool for all kind of borings. Excellent cutting features guarantee a smooth surface by unequally divided cutting edges. Reduction of feed force and chatter marks on the countersinking surface due to reduced axial and radial force.

### ES Avellanador cónico HSS Cobalto, larga, división irregular, DIN 335 C, 90°

**Ámbito de aplicación:**

Para todos los metales E y NE y plásticos duros y blandos. Herramienta para desbarbar y avellanar de aplicación universal para agujeros de todo tipo. Excelentes características de corte, por corte desigual dividida.

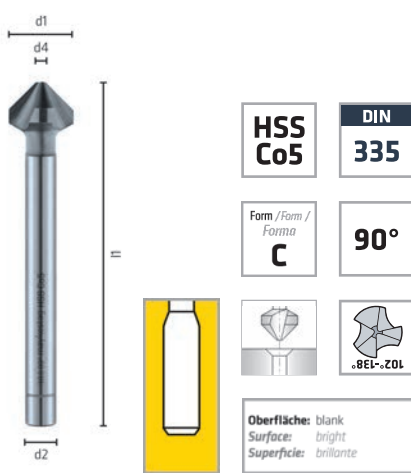

Einzelverpackung mit Aufhänger  
Single pack with tag  
Embalaje individual con gancho para autoservicio



**ALUNIT®**  
Höhere Performance, längere Standzeit  
Higher performance, longer durability  
Rendimiento superior tiempo de uso más prolongado





Einzelverpackung mit Aufhänger  
Single pack with tag  
Embalaje individual con gancho para autoservicio

							blank / bright / brillante	ALUNIT®	
d1	d4		d2 <sub>h9</sub>	l1	Z	Code 2340	Inh.	Code 2347	Inh.
mm	mm		mm	mm		Art.-Nr.	Cont.	Art.-Nr.	Cont.
6,30	1,50	M3	5,00	104	3	0234000630100	1	0234700630100	1
8,30	2,00	M4	6,00	105	3	0234000830100	1	0234700830100	1
10,40	2,50	M5	6,00	107	3	0234001040100	1	0234701040100	1
12,40	2,80	M6	8,00	108	3	0234001240100	1	0234701240100	1
16,50	3,20	M8	10,00	111	3	0234001650100	1	0234701650100	1
20,50	3,50	M10	10,00	114	3	0234002050100	1	0234702050100	1
25,00	3,80	M12	10,00	118	3	0234002500100	1	0234702500100	1
31,00	4,20	M16	12,00	140	3	0234003100100	1	0234703100100	1

**D** Kassetten, Sets

**E** Cassettes, sets

**ES** Cajas, juegos

HSS Co5 Kegelsenker-Satz, 6-tlg.		HSS Co5 Kegelsenker-Satz, 6-tlg.	
			
6-tlg. / 6-pcs. / 6-unid. Kunststoffkassette / Plastic cassette / Caja de plástico Art.-Nr. 0234000006100		6-tlg. / 6-pcs. / 6-unid. Kunststoffkassette / Plastic cassette / Caja de plástico Art.-Nr. 0234700006100	
Ø mm	Stk. <sup>(1)</sup> pc. <sup>(1)</sup>	Ø mm	Stk. <sup>(1)</sup> pc. <sup>(1)</sup>
MAYKESTAG		MAYKESTAG	
Ø 6,3 / 8,3 / 10,4 / 12,4 / 16,5 / 20,5	1	Ø 6,3 / 8,3 / 10,4 / 12,4 / 16,5 / 20,5	1



Gewinde-, Senk- und Schälwerkzeuge  
Taps, dies, countersinks and conecut  
herramientas para roscar, avellanar y escarpar

<sup>(1)</sup> Stück je Abmessung / Pieces each dimension / Piezas por diámetro

**① HSS Cobalt Kegelsenker,  
DIN 335 C, 90°**

**Einsatzbereich:**

Für alle E- und NE-Metalle, Kunststoffe hart und weich. Universell einsetzbares Entgrat- und Senkwerkzeug für Bohrungen aller Art. Sehr gute Schneideigenschaften ohne "Rat-termarken", durch radialen Hinterschliff leicht nachschärfbar an der Spanfläche.



Hitzebeständig  
Heat resistant  
Termoestable



Präzise  
Precise  
Preciso



Industriequalität  
Industrial quality  
Calidad industrial

**② HSS Cobalt countersinks,  
DIN 335 C, 90°**

**Range of application:**

For ferrous and non-ferrous metals, synthetic materials soft and hard. Universal deburring and sink tool for all kind of borings. Excellent cutting features guarantee a smooth surface without burrs; profile relief facilitates an easy regrind.

**③ Avellanador cónico HSS Cobalto,  
DIN 335 C, 90°**

**Ámbito de aplicación:**

Para todos los metales E y NE y plásticos duros y blandos. Herramienta para desbarbar y avellanar de aplicación universal para agujeros de todo tipo. Excelentes características de corte sin "rayado transversal", fácil reafileado de la superficie de deslizamiento gracias al talón radial.

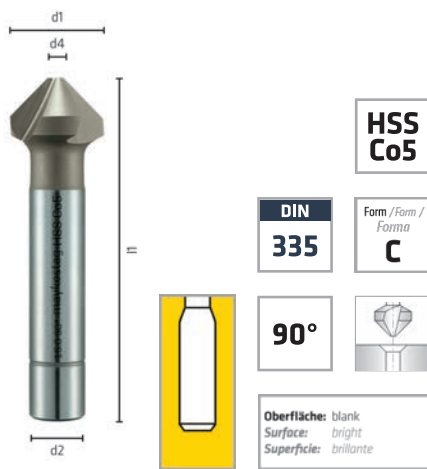

Einzelverpackung mit Aufhänger  
Single pack with tag  
Embalaje individual con gancho para autoservicio



**ALUNIT®**  
Höhere Performance,  
längere Standzeit  
Higher performance,  
longer durability  
Rendimiento superior  
tiempo de uso más  
prolongado

Einzelverpackung mit Aufhänger  
Single pack with tag  
Embalaje individual con gancho para autoservicio



							blank / bright / brillante	ALUNIT®	
d1	d4		d2 <sub>h9</sub>	l1	Z	Code 2290	Inh.	Code 2297	Inh.
mm	mm		mm	mm		Art.-Nr.	Cont.	Art.-Nr.	Cont.
4,30	1,30	M 2	4,00	40	3	0229000430100	1		
5,00	1,50		4,00	40	3	0229000500100	1	0229700500100	1
5,30	1,50		4,00	40	3	0229000530100	1		
6,00	1,50		5,00	45	3	0229000600100	1	0229700600100	1
6,30	1,50	M 3	5,00	45	3	0229000630100	1	0229700630100	1
8,00	2,00		6,00	50	3	0229000800100	1	0229700800100	1
8,30	2,00	M 4	6,00	50	3	0229000830100	1	0229700830100	1
9,40	2,20		6,00	50	3	0229000940100	1		
10,00	2,50		6,00	50	3	0229001000100	1	0229701000100	1
10,40	2,50	M 5	6,00	50	3	0229001040100	1	0229701040100	1
11,50	2,80		8,00	56	3	0229001150100	1		
12,40	2,80	M 6	8,00	56	3	0229001240100	1	0229701240100	1
13,40	2,90		8,00	56	3	0229001340100	1		
15,00	3,20		10,00	60	3	0229001500100	1	0229701500100	1
16,50	3,20	M 8	10,00	60	3	0229001650100	1	0229701650100	1
19,00	3,50		10,00	63	3	0229001900100	1	0229701900100	1
20,50	3,50	M 10	10,00	63	3	0229002050100	1	0229702050100	1
23,00	3,80		10,00	67	3	0229002300100	1		
25,00	3,80	M 12	10,00	67	3	0229002500100	1	0229702500100	1
31,00	4,20		12,00	71	3	0229003100100	1	0229703100100	1



**D** Kassetten, Sets

**E** Cassettes, sets

**ES** Cajas, juegos

HSS Cobalt Kegelsenker-Satz KM 4		HSS Cobalt Kegelsenker-Satz KM 6		HSS Cobalt Kegelsenker-Satz KM 4	
					
4-tlg. / 4-pcs. / 4-unid. Metallkassette / Metal cassette / Caja de metal Art.-Nr. 0229000004100		6-tlg. / 6-pcs. / 6-unid. Metallkassette / Metal cassette / Caja de metal Art.-Nr. 0229000096100		4-tlg. / 4-pcs. / 4-unid. Metallkassette / Metal cassette / Caja de metal Art.-Nr. 0229700004100	
Ø mm	Stk. <sup>(1)</sup> pc. <sup>(1)</sup>	Ø mm	Stk. <sup>(1)</sup> pc. <sup>(1)</sup>	Ø mm	Stk. <sup>(1)</sup> pc. <sup>(1)</sup>
MAYKESTAG		MAYKESTAG		MAYKESTAG	
Ø 10,40 / 16,50 / 20,50 / 25,00	1	Ø 6,30 / 8,30 / 10,40 / 12,40 / 16,50 / 20,50	1	Ø 10,40 / 16,50 / 20,50 / 25,00	1



Gewinde-, Senk- und Schälwerkzeuge  
 Taps, dies, countersinks and conecut  
 herramientas para roscar, avellanar y escarpar

<sup>(1)</sup> Stück je Abmessung / Pieces each dimension / Piezas por diámetro



**SINK HERO**



**Beste Performance**

Dank des optimalen Hinterschliffs

**Best performance**

Due to the optimal relief

**El mejor rendimiento**

Gracias al talón óptimo

**Herausragende Ergebnisse**

Präzise Bohrleistungen sorgen für ein perfektes Senkbild

**Outstanding results**

Precise drilling performance ensures a perfect surface

**Resultados excelentes**

Las potencias de perforación precisas crean una imagen perforada perfecta

**Ruhiger Lauf**

Rattermarken werden vermieden

**Smooth running**

Avoiding chatter marks

**Funcionamiento tranquilo**

prevención de marcas por vibraciones



**alpen** *drill better.*

**D** HSS Kegelsenker,  
ungleiche Teilung,  
DIN 335 C, 90°

**Einsatzbereich:**

Für alle E- und NE-Metalle, Kunststoffe hart und weich. Universell einsetzbares Entgrat- und Senkwerkzeug für Bohrungen aller Art. Sehr gute Schneideigenschaften durch ungleichgeteilte Schneiden. Verringerung der Vorschubkraft und Ratterbildung an der Senkoberfläche durch reduzierte Axial- und Radialkraft.



Hitzebeständig  
Heat resistant  
Termoestable



Präzise  
Precise  
Preciso



Industriequalität  
Industrial quality  
Calidad industrial

**E** HSS countersinks,  
different partition,  
DIN 335 C, 90°

**Range of application:**

For ferrous and non-ferrous metals, synthetic materials soft and hard. Universal deburring and sink tool for all kind of borings. Excellent cutting features guarantee a smooth surface by unequally divided cutting edges. Reduction of feed force and chatter marks on the countersinking surface due to reduced axial and radial force.

**ES** Avellanador cónico HSS,  
división irregular,  
DIN 335 C, 90°

**Ámbito de aplicación:**

Para todos los metales E y NE y plásticos duros y blandos. Herramienta para desbarbar y avellanar de aplicación universal para agujeros de todo tipo. Excelentes características de corte, por corte desigual dividida. Reducción del avance y de vibración en la superficie avellanada gracias a las fuerzas axiales y radiales reducidas.



Einzelverpackung mit Aufhänger  
Single pack with tag  
Embalaje individual con gancho para autoservicio

d1 mm	d4 mm		d2 <sub>h9</sub> mm	l1 mm	Z	Code 2320 Art.-Nr.	Inh. Cont.
6,30	1,50	M 3	5,00	45	0	0232000630100	1
8,30	2,00	M 4	6,00	50	0	0232000830100	1
10,40	2,50	M 5	6,00	50	0	0232001040100	1
12,40	2,80	M 6	8,00	56	0	0232001240100	1
16,50	3,20	M 8	10,00	60	0	0232001650100	1
20,50	3,50	M 10	10,00	63	0	0232002050100	1
25,00	3,80	M 12	10,00	67	0	0232002500100	1
31,00	4,20		12,00	71	0	0232003100100	1

<b>Standard Kegelsenker</b>	<b>mit ungleicher Teilung</b>
Standard countersink	with different partition
Avellanador cónico estándar	con división irregular



Gewinde-, Senk- und Schälwerkzeuge  
Taps, dies, countersinks and conecut  
herramientas para roscar, avellanar y escarpar

🇩🇪 Kassetten, Sets

🇪🇸 Cassettes, sets

🇪🇸 Cajas, juegos

HSS Kegelsenker-Satz KP 3

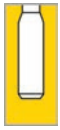

3-tlg. / 3-pcs. / 3-unid.  
Kunststoffbox / Plastic box / Caja de plástico  
Art.-Nr. 0232000003100

Ø mm	Stk. <sup>(1)</sup> pc. <sup>(1)</sup>
Sink Hero	
Ø 12,40 / 16,50 / 20,50	1

HSS Kegelsenker-Satz KM 6



6-tlg. / 6-pcs. / 6-unid.  
Metallkassette / Metal cassette / Caja de metal  
Art.-Nr. 0232000006100

Ø mm	Stk. <sup>(1)</sup> pc. <sup>(1)</sup>
Sink Hero	
Ø 6,30 / 8,30 / 10,40 / 12,40 / 16,50 / 20,50	1

<sup>(1)</sup> Stück je Abmessung / Pieces each dimension / Piezas por diámetro

**D HSS Kegelsenker,  
DIN 335 C, 90°**

**Einsatzbereich:**

Für alle E- und NE-Metalle, Kunststoffe hart und weich. Universell einsetzbares Entgrat- und Senkwerkzeug für Bohrungen aller Art. Sehr gute Schneideigenschaften ohne "Rat-termarken", durch radialen Hinterschliff leicht nachschärfbar an der Spanfläche.



Hitzebeständig  
Heat resistant  
Termoestable



Präzise  
Precise  
Preciso



Industriequalität  
Industrial quality  
Calidad industrial

**E HSS countersinks,  
DIN 335 C, 90°**

**Range of application:**

For ferrous and non-ferrous metals, synthetic materials soft and hard. Universal deburring and sink tool for all kind of borings. Excellent cutting features guarantee a smooth surface without burrs; profile relief facilitates an easy regrind.

**ES Avellanador cónico HSS,  
DIN 335 C, 90°**

**Ámbito de aplicación:**

Para todos los metales E y NE y plásticos duros y blandos. Herramienta para desbarbar y avellanar de aplicación universal para agujeros de todo tipo. Excelentes características de corte sin "rayado transversal", fácil reaflado de la superficie de deslizamiento gracias al talón radial.



Einzelverpackung mit Aufhänger  
Single pack with tag  
Embalaje individual con gancho para autoservicio

d1 mm	d4 mm		d2 <sub>h9</sub> mm	l1 mm	Z	Code 2292 Art.-Nr.	Inh. Cont.
6,30	1,50	M 3	5,00	45	3	0229200630100	1
8,30	2,00	M 4	6,00	50	3	0229200830100	1
10,40	2,50	M 5	6,00	50	3	0229201040100	1
12,40	2,80	M 6	8,00	56	3	0229201240100	1
16,50	3,20	M 8	10,00	60	3	0229201650100	1
20,50	3,50	M 10	10,00	63	3	0229202050100	1
25,00	3,80	M 12	10,00	67	3	0229202500100	1



Gewinde-, Senk- und Schälwerkzeuge  
Taps, dies, countersinks and conical  
herramientas para roscar, avellanar y escarpar

① Kassetten, Sets

Ⓔ Cassettes, sets

Ⓔ Cajas, juegos

HSS Kegelsenker-Satz KM 3

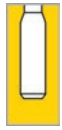

3-tlg. / 3-pcs. / 3-unid.  
Kunststoffbox / Plastic box / Caja de plástico  
Art.-Nr. 0229200003100

Ø mm	Stk. <sup>(1)</sup> pc. <sup>(1)</sup>
HSS Kegelsenker	
Ø 12,40 / 16,50 / 20,50	1

HSS Kegelsenker-Satz KM 6



6-tlg. / 6-pcs. / 6-unid.  
Metallkassette / Metal cassette / Caja de metal  
Art.-Nr. 0229200096100

Ø mm	Stk. <sup>(1)</sup> pc. <sup>(1)</sup>
HSS Kegelsenker	
Ø 6,30 / 8,30 / 10,40 / 12,40 / 16,50 / 20,50	1

<sup>(1)</sup> Stück je Abmessung / Pieces each dimension / Piezas por diámetro

**D HSS Cobalt Entgratsenker mit Querlochbohrung**

**Einsatzbereich:**

Die günstige Schneidengeometrie ergibt einen leichten schälenden Schnitt. Die Späne werden in Schafrichtung abgeführt und können die Senkung nicht beschädigen. Zum leichten und ratterfreien Entgraten von Bohrungen. Besonders geeignet für weiche langspanende Werkstoffe.



Verschleissfest  
Wear-resistant  
Resistente al desgaste



Präzise  
Precise  
Preciso

**E HSS Cobalt slotted countersink hole type**

**Range of application:**

Countersink and deburring tool with through hole which is ideal for long chip materials, such as aluminium and very effective on both hard and softwoods. Spoil is removed through centre of cutter to prevent damage to tool.

**ES Broca avellanadora para desbarbar HSS Cobalt con taladro para agujeros transversales**

**Ámbito de aplicación:**

La geometría de corte idónea facilita un corte escarpado. Las virutas se eliminan en la dirección del eje y no pueden causar daños en el avellanado. Para el desbarbado de agujeros fácil y sin vibraciones. Especialmente adecuada para materiales blandos de virutas largas.

HSS Co5

90°

Oberfläche: blank  
Surface: bright  
Superficie: brillante

Drehpack mit Aufhänger  
Twistpack with tag  
Paquete giratorio con gancho para autoservicio

Größe Size / Tamaño	d1 mm	d2 mm	Bereich / Range Intervalo Ø mm	Code 2291 Art.-Nr.	Inh. Cont.
1	10,00	6	2-5	0229101000100	1
2	14,00	8	5-10	0229101400100	1
3	21,00	10	10-15	0229102100100	1
4	28,00	12	15-20	0229102800100	1
5	35,00	15	20-25	0229103500100	1

**HSS Cobalt Querlochenersatz BOX 3**



3-tlg. / 3-pcs. / 3-unid.  
Kunststoffbox / Plastic box / Caja de plástico  
Art.-Nr. 0229100003100

Ø mm	Stk. <sup>(1)</sup> pc. <sup>(1)</sup>
HSS Cobalt Ø 10,00 / 14,00 / 21,00	1

<sup>(1)</sup> Stück je Abmessung / Pieces each dimension / Piezas por diámetro



Gewinde-, Senk- und Schälwerkzeuge  
Taps, dies, countersinks and conecut  
herramientas para roscar, avellanar y escarpar

① HSS Kegelsenker 90° mit 1/4"-Sechskantschaft

**Einsatzbereich:**

Zum Senken, Anfasen und Entgraten, für Metall- und Kunststoffbearbeitung. Zur direkten Verwendung in Elektro-Handbohrmaschinen, Elektro-Schraubern und Akku-Maschinen mit Sechskantaufnahme oder über magnetischen Universalhalter.



Verschleissfest  
Wear-resistant  
Resistente al desgaste



Präzise  
Precise  
Preciso

② HSS countersink 90° with 1/4" hexagonal shank

**Range of application:**

Countersink and deburring tool suitable for either metal or synthetic materials. Manufactured with 1/4" hexagonal shank for direct use in standard chuck, cordless drills or through a magnetic bit holder.

③ Avellanador cónico HSS, 90° con eje hexagonal 1/4"

**Ámbito de aplicación:**

Para el avellanado, el biselado y el desbarbado, para el procesamiento de metal y plástico. Para su uso directo en taladradoras manuales eléctricas, destornilladores eléctricos y máquinas a batería con toma hexagonal o mediante soporte universal magnético.

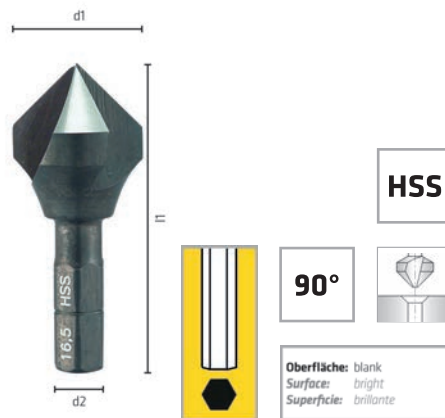

Drehpack mit Aufhänger  
Twistpack with tag  
Paquete giratorio con gancho para autoservicio

d1 mm			l1 mm	Z	Code 720 Art.-Nr.	Inh. Cont.
6,30	M 3	1/4"	31	3	0072000630100	1
8,30	M 4	1/4"	31	3	0072000830100	1
10,40	M 5	1/4"	34	3	0072001040100	1
12,40	M 6	1/4"	35	3	0072001240100	1
16,50	M 8	1/4"	40	3	0072001650100	1
20,50	M 10	1/4"	41	3	0072002050100	1

HSS Senkerbitsatz BOX 3

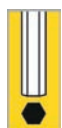

3-tlg. / 3-pcs. / 3-unid.  
Kunststoffbox / Plastic box / Caja de plástico  
Art.-Nr. 0072000003100

Ø mm	Stk. <sup>(1)</sup> pc. <sup>(1)</sup>
HSS	
Ø 12,40 / 16,50 / 20,50	1

<sup>(1)</sup> Schaft nach DIN 3126, Form C6.3, ISO 1173  
Shank DIN 3126, Form C6.3, ISO 1173  
Eje según DIN 3126, forma C6.3, ISO 1173

<sup>(1)</sup> Stück je Abmessung / Pieces each dimension / Piezas por diámetro



**D** Stufenbohrer

**E** Step drill

**ES** Broca progresiva

**Einsatzbereich:**

Zum Bohren zylindrischer Löcher in Material bis 4 bzw. 6 mm Stärke. Bohren und Entgraten erfolgt in einem Arbeitsgang durch die schrägen Schneiden der nächstfolgenden Bohrstufe. Zur Vermeidung von Materialansatz Bohrpaste (Code 721000021) verwenden.

**Range of application:**

Multiple step and countersink tool for drilling and countersinking in one smooth operation. Suitable for materials with a maximum thickness of 4-6 mm, dependent on hardness. The use of cutting paste (Code 721000021) is recommended.

**Ámbito de aplicación:**

Para el taladrado de agujeros cilíndricos en materiales con un grosor de 4 mm a 6 mm. El taladrado y el desbarbado se realizan en una sola operación gracias a los filos oblicuos del siguiente nivel de broca. Debe utilizarse pasta para taladrar (código 721000021) para evitar las rebabas de material.



Verschleissfest  
Wear-resistant  
Resistente al desgaste



Präzise  
Precise  
Preciso



**HSS Co5 TiN**

HSS Co5    HSS

Oberfläche: blank  
Surface: bright  
Superficie: brillante



Drehpack mit Aufhänger  
Twistpack with tag  
Paquete giratorio con gancho para autoservicio



Drehpack mit Aufhänger  
Twistpack with tag  
Paquete giratorio con gancho para autoservicio



**TiN**

Hohe Performance, lange Standzeit  
High performance, long durability  
Rendimiento elevado, duración prolongada

Drehpack mit Aufhänger  
Twistpack with tag  
Paquete giratorio con gancho para autoservicio

Größe Size / Tamaño	d1 - d4 mm	d2 mm	HSS		HSS Co5		HSS Co5 TiN	
			Code 722 Art.-Nr.	Inh. Cont.	Code 726 Art.-Nr.	Inh. Cont.	Code 728 Art.-Nr.	Inh. Cont.
1	4,00-12,00	6	0072200412100	1	0072600412100	1		
2	4,00-20,00	8	0072201220100	1	0072600620100	1		
3	6,00-30,00	10	0072200630100	1	0072600630100	1	0072800630100	1
4	6,00-37,00 (PG 7-29)	10	0072200729100	1	0072600729100	1	0072800729100	1

Oberfläche: blank/TiN Code 728 TiN-beschichtet  
Surface: bright/TiN Code 728 TiN-coated  
Superficie: brillante/TiN Code 728 Recubierto con TiN





Gewinde-, Senk- und Schälwerkzeuge  
Taps, dies, countersinks and conecut  
herramientas para roscar, avellanar y escarpar

① Kassetten, Sets

Ⓔ Cassettes, sets

Ⓔ Cajas, juegos

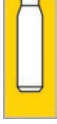
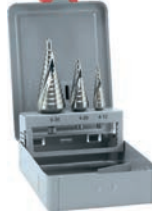
HSS Stufenbohrer KM 3		HSS Cobalt Stufenbohrer KM 3	
			
<p>3-tlg. / 3-pcs. / 3-unid. Metallkassette / Metal cassette / Caja de metal Art.-Nr. 0072200003100</p>		<p>3-tlg. / 3-pcs. / 3-unid. Metallkassette / Metal cassette / Caja de metal Art.-Nr. 0072600003100</p>	
Inhalt	Stk. <sup>(1)</sup>	Inhalt	Stk. <sup>(1)</sup>
<i>Contents / Contenido</i>	<i>pc. <sup>(1)</sup></i>	<i>Contents / Contenido</i>	<i>pc. <sup>(1)</sup></i>
Größe / Size / Tamaño: 12,00 / 20,00 / 30,00	1	Größe / Size / Tamaño: 12,00 / 20,00 / 30,00	1

<sup>(1)</sup> Stück je Abmessung / Pieces each dimension / Piezas por diámetro

**D** Blechschälbohrer

**E** Conecut

**ES** Broca cónica para chapa

**Einsatzbereich:**

Zum Bohren größerer Löcher in dünnes Material oder zum Aufbohren bereits vorhandener Löcher. Zum grat- und rattermarkenfreien Bohren oder Aufbohren (ohne Vorbohren) in Nirostablechen und weichen Werkstoffen. Für Hand- oder Ständerbohrmaschinen geeignet.

**Range of application:**

For drilling large-diameter holes in thin material or for expanding pre-cut holes. For drilling without burr or chatter marks and widening holes (without piloting) in non-rusting sheet and soft materials. Suitable for hand-held and upright drilling machines.

**Ámbito de aplicación:**

Para taladrar agujeros grandes en material fino o ampliar agujeros ya existentes. Para taladrar o ampliar (sin taladrado previo) agujeros sin dejar rebabas ni marcas en chapas con acero inoxidable y materiales blandos. Adecuada para taladradoras manuales o con soporte.



Verschleissfest  
Wear-resistant  
Resistente al desgaste



Präzise  
Precise  
Preciso



**HSS Co5 TiN**

HSS Co5    HSS

Oberfläche: blank  
Surface: bright  
Superficie: brillante



Drehpack mit Aufhänger  
Twistpack with tag  
Paquete giratorio con gancho para autoservicio



Drehpack mit Aufhänger  
Twistpack with tag  
Paquete giratorio con gancho para autoservicio



**TiN**

Hohe Performance, lange Standzeit  
High performance, long durability  
Rendimiento elevado, duración prolongada

Drehpack mit Aufhänger  
Twistpack with tag  
Paquete giratorio con gancho para autoservicio

Größe Size / Tamaño	d1 - d4 mm	d2 mm	blank / bright / brillante		HSS Co5		HSS Co5 TiN	
			Code 721 Art.-Nr.	Inh. Cont.	Code 723 Art.-Nr.	Inh. Cont.	Code 725 Art.-Nr.	Inh. Cont.
1	3,50 - 14,00	6	0072100314100	1	0072300314100	1	0072500314100	1
2	6,00 - 20,00	8	0072100820100	1	0072300620100	1	0072500620100	1
3	16,00 - 30,00	10	0072101630100	1	0072301630100	1	0072501630100	1
4	24,00 - 40,00	12	0072102640100	1				
5	36,00 - 50,00	13	0072103650100	1				
6	40,00 - 61,00	13	0072104061100	1				
L	6,00 - 30,00	10	0072100430100	1				
2A	3,00 - 22,00	8	0072100522100	1				
2A	5,00 - 25,00	8	0007202500100	1				







Gewinde-, Senk- und Schälwerkzeuge  
Taps, dies, countersinks and cone-cut  
herramientas para roscar, avellanar y escarpar

Oberfläche: blank/TiN Code 728 TiN-beschichtet / Surface: bright/TiN Code 728 TiN-coated / Superficie: brillante/TiN Code 728 Recubierto con TiN  
Oberfläche: blank/TiN Code 725 TiN-beschichtet / Surface: bright/TiN Code 725 TiN-coated / Superficie: brillante/TiN Code 725 Recubierto con TiN

① Kassetten, Sets

Ⓔ Cassettes, sets

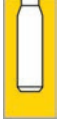
Ⓔ Cajas, juegos

HSS Blechschälbohrer KM 3		HSS Cobalt Blechschälbohrer KM 3	
			
<p>3-tlg. / 3-pcs. / 3-unid.                      Metallkassette / Metal cassette / Caja de metal                      Art.-Nr. 0072100003100</p>		<p>3-tlg. / 3-pcs. / 3-unid.                      Metallkassette / Metal cassette / Caja de metal                      Art.-Nr. 0072300003100</p>	
Inhalt Contents / Contenido	Stk. <sup>(1)</sup> pc. <sup>(1)</sup>	Inhalt Contents / Contenido	Stk. <sup>(1)</sup> pc. <sup>(1)</sup>
Größe / Size / Tamaño: 1 / 2 / 3 Ø 3,5 - 30,0 mm	1	Größe / Size / Tamaño: 1 / 2 / 3 Ø 3,5 - 30,0 mm	1

<sup>(1)</sup> Stück je Abmessung / Pieces each dimension / Piezas por diámetro

**D** Universal-Fräsbohrer

**E** Drill file rasp

**ES** Broca fresadora universal

**Einsatzbereich:**

Zum Bohren und anschließendem Ausfräsen von Blech und dünnwandigem Material. Besonders bei Montagearbeiten gut geeignet, um mit diesem kleinen Bohrer größere Löcher und verschiedene Formen herzustellen.

**Range of application:**

For drilling and cutting holes in sheet metal and similar thin materials. Ideal for large holes and irregular shapes, manufactured in TiN coated HSS.

**Ámbito de aplicación:**

Para el taladrado y el fresado de chapas y material f. no. Especialmente adecuado en trabajos de montaje para hacer agujeros más grandes y diferentes formas con esta broca pequeña.



Verschleissfest  
Wear-resistant  
Resistente al desgaste



Präzise  
Precise  
Preciso

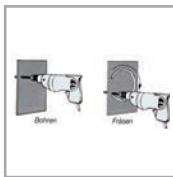
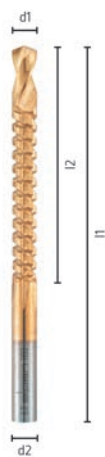

Oberfläche: TiN  
Surface: TiN  
Superficie: TiN



Einzelverpackung  
Single pack  
Embalaje individual

d1 mm	l1 mm	l2 mm	Code 721 Art.-Nr.	Inh. Cont.
6,00	89	57	0072100001100	1
8,00	93	57	0072100011100	1



Gewinde-, Senk- und Schälwerkzeuge  
Taps, dies, countersinks and conical  
herramientas para roscar, avellanar y escarpar

Oberfläche: blank/TiN Code 728 TiN-beschichtet / Surface: bright/TiN Code 728 TiN-coated / Superficie: brillante/TiN Code 728 Recubierto con TiN  
Oberfläche: blank/TiN Code 725 TiN-beschichtet / Surface: bright/TiN Code 725 TiN-coated / Superficie: brillante/TiN Code 725 Recubierto con TiN

**D** Drehzahlen

**E** Spindle speeds

**ES** Velocidades

Die angegebenen Drehzahlempfehlungen beziehen sich auf Standardanwendungen.

The recommended spindle speeds refer to standard applications.

Las recomendaciones indicadas de las velocidades se refieren a aplicaciones estándar.

n: Drehzahl U/min







n: Spindle speed rpm

n: Velocidad r.p.m.

Maschinengewindebohrer / Machine taps / Macho para roscar a máquina



Code 704, 709, 714, 719

Ø mm							
	<400 N/mm²	<850 N/mm²	<1.300 N/mm²	GRAUGUSS CAST IRON GISHA GRIGIA	Cu Ms Ni Zn	Alu	Gears
3	n 1698	n 1698	n 1273	n 1061	n 1273	n 1910	n 1061
4	n 1273	n 1273	n 955	n 796	n 955	n 1432	n 796
5	n 1019	n 1019	n 764	n 637	n 764	n 1146	n 637
6	n 849	n 849	n 637	n 531	n 637	n 955	n 531
8	n 637	n 637	n 477	n 398	n 477	n 716	n 398
10	n 509	n 509	n 382	n 318	n 382	n 573	n 318
12	n 424	n 424	n 318	n 265	n 318	n 477	n 265
Kühlung Coolant Refrigeración	E/O	E/O	E/O	T	E/O	E/O	T/D

E: Emulsion | Emulsion | emulsión, O: Öl | Oil | aceite, T: trocken | dry | seco, D: Druckluft | compressed air | aire comprimido







**D** Drehzahlen

**E** Spindle speeds

**ES** Velocidades

Die angegebenen Drehzahlempfehlungen beziehen sich auf Standardanwendungen. Bohren ins Volle möglich. Wir empfehlen mit Ø 4,0 bzw. Ø 6,0 mm vorzubohren.

The recommended spindle speeds refer to standard applications. Drilling into the whole material possible. We would recommend to pre-drill with Ø 4,0 or Ø 6,0 mm.

Las recomendaciones indicadas de las velocidades se refieren a aplicaciones estándar. Recomendamos pretaladrar con Ø 4,0 o 6,0 mm.

n: Drehzahl U/min

n: Spindle speed rpm

n: Velocidad r.p.m.

**HSS und HSS Co5 Stufenbohrer und Blechschälbohrer / HSS and HSS Co5 step drill and conecut / Brocas progresivas y brocas cónicas para chapa HSS e HSS Co5**



Code 721, 722, 723, 725, 726, 728

Ø mm												
	n	n	n	n	n	n	n	n	n	n	n	
4,0	1989	1592	1194	796	4377	2387	2387	1194				
5,0	1592	1273	955	637	3501	1910	1910	955				
6,0	1326	1061	796	531	2918	1592	1592	796				
7,0	1137	909	682	455	2501	1364	1364	682				
8,0	995	796	597	398	2188	1194	1194	597				
9,0	884	707	531	354	1945	1061	1061	531				
10,0	796	637	477	318	1751	955	955	477				
11,0	723	579	434	289	1592	868	868	434				
12,0	663	531	398	265	1459	796	796	398				
12,5	637	509	382	255	1401	764	764	382				
14,0	568	455	341	227	1251	682	682	341				
15,2	524	419	314	209	1152	628	628	314				
16,0	497	398	298	199	1094	597	597	298				
18,0	442	354	265	177	973	531	531	265				
18,6	428	342	257	171	941	513	513	257				
20,0	398	318	239	159	875	477	477	239				
20,4	390	312	234	156	858	468	468	234				
22,0	362	289	217	145	796	434	434	217				
24,0	332	265	199	133	729	398	398	199				
26,0	306	245	184	122	673	367	367	184				
28,0	284	227	171	114	625	341	341	171				
30,0	265	212	159	106	584	318	318	159				
34,0	234	187	140	94	515	281	281	140				
37,0	215	172	129	86	473	258	258	129				
<b>Kühlung Coolant Refrigeración</b>	Bohrpaste Cutting paste Pasta para taladrar	Bohrpaste Cutting paste Pasta para taladrar	Bohrpaste Cutting paste Pasta para taladrar	Bohrpaste Cutting paste Pasta para taladrar	Druckluft compressed air aire comprimido	Druckluft compressed air aire comprimido	Bohrpaste Cutting paste Pasta para taladrar	Wasser/trocken Water/dry Agua/seco				

1) kurzspanend / short chipping / de viruta corta 2) langspanend / long chipping / de viruta larga



Gewinde-, Senk- und Schälwerkzeuge  
Taps, dies, countersinks and conecut  
herramientas para roscar, avellanar y escarpar

## ① Verkaufs- und Lieferbedingungen

### 1. Angebot, Auftrag, Preis

1.1 Die nachstehenden Verkaufs- und Lieferbedingungen gelten für alle mit uns abgeschlossenen Verträge. Anderslautende Bedingungen sind für uns nur dann bindend, wenn sie von uns schriftlich anerkannt werden. Das gilt auch für den Fall, dass ein Besteller auf seine eigenen Einkaufsbedingungen verweist. Mündliche Vereinbarungen, die für uns eine zusätzliche Verpflichtung beinhalten, sind nur dann bindend, wenn sie von uns schriftlich bestätigt werden.

1.2. Unsere Preise sind freibleibend. Die in der Preisliste angegebenen Maße entsprechen den jeweils gültigen Normen und werden bei Änderung der Normmaße entsprechend abgeändert.

1.3. Unsere Preise verstehen sich ohne die gesetzliche Mehrwertsteuer ab Werk. Verpackung, Fracht und Transportversicherungskosten gehen zu Lasten des Bestellers.

1.4. Bei einer auf elektronischem Wege bestellten Ware werden wir den Zugang der Bestellung des Kunden unverzüglich bestätigen. Die Zugangsbestätigung stellt noch keine verbindliche Annahmeerklärung der Bestellung dar; außer wenn wir dies ausdrücklich erklären. Bei auf elektronischem Wege bestellter Ware sind wir berechtigt, die Bestellung innerhalb von drei Werktagen nach Eingang bei uns anzunehmen.

### 2. Zahlungsziel,

#### Zahlungsbedingungen, Rücktritt

2.1. Unsere Rechnungen sind 30 Tage ab Rechnungsdatum netto ohne Abzug zur Zahlung fällig. Der Kaufpreis ist sofort fällig, wenn der Besteller uns gegenüber mit anderen Zahlungsverpflichtungen in Zahlungsverzug gerät. Bei Überschreitung der Zahlungsfrist werden unter Vorbehalt der Geltendmachung eines weiteren Verzugs Schadens 12% Verzugszinsen ab Verfalltag bis zum Zahlungstag in Rechnung gestellt.

2.2. Der Besteller hat ein Recht zur Aufrechnung nur, wenn seine Ansprüche rechtskräftig festgestellt wurden oder durch uns anerkannt wurden.

2.3. Bleibt der Besteller mit der Zahlung länger als 30 Tage im Rückstand, werden bei ihm Pfändungen durchgeführt oder verschlechtert sich seine Vermögenslage beträchtlich, sind wir berechtigt, von allen noch nicht erfüllten Lieferverträgen zurückzutreten oder Vorauszahlungen zu fordern.

### 3. Lieferung

3.1. Teillieferungen sind zulässig.

3.2. Wir sind bemüht die Lieferfristen so genau wie möglich einzuhalten. Lieferfristen sind nicht verbindlich. Fällt das Ende der Lieferfrist in die Zeit des Betriebsurlaubs, so verlängert sich die Lieferfrist um die Dauer des Betriebsurlaubs. Auf jeden Fall sind Schadenersatzansprüche oder Aufhebung des Vertrages wegen verspäteter Lieferung ausgeschlossen, wenn uns nicht krass grobe Fahrlässigkeit nachgewiesen wird.

### 4. Gefahrübergang

Der Versand erfolgt stets auf Rechnung und Gefahr des Bestellers. Für Beschädigungen und Verluste während des Transportes haften wir nicht. Mangels besonderer Versandvorschriften des Bestellers haben wir die Versendung auf dem nach unserem Ermessen besten Weg zu bewirken. Werden vom Besteller keine anderweitigen Vorschriften über die Versicherung gegen Transportschäden gemacht, so kann dies auf Kosten des Bestellers von uns ohne weiteres vorgenommen werden. Eine Versicherungspflicht unsererseits besteht jedoch nicht.

### 5. Eigentumsvorbehalt

Die gelieferte Ware bleibt unbeschadet des früheren Gefahrüberganges bis zur vollständigen Bezahlung aller aus dem Liefervertrag entstandenen Verbindlichkeiten des Bestellers unser Eigentum. Solange die Ware unser Eigentum ist, ist der Besteller nicht berechtigt, die gelieferte Ware einem Dritten zu verpfänden oder sicherungsweise zu übereignen. Droht unserem Eigentum von dritter Seite Gefahr, so sind wir unverzüglich zu benachrichtigen. Sollte ein Gerichtsvollzieher die gelieferte Ware pfänden wollen, so ist gegenüber dem Gerichtsvollzieher unser Eigentum unter Nennung unserer Firma und unserer Anschrift zu behaupten. Der Besteller hat uns alle Schäden und Kosten zu ersetzen, die durch einen Verstoß gegen diese Verpflichtungen und durch erforderliche Interventionsmaßnahmen gegen Zugriffe Dritter auf die Ware entstehen.

### 6. Gewährleistung, Haftungsbeschränkung und -Freistellung

6.1. Der Besteller hat eine Lieferung sofort nach Anlieferung eingehend zu untersuchen. Beanstandungen wegen unvollständiger Lieferung oder wegen entdeckter Mängel sind binnen 8 Tagen nach Empfang der einzelnen Lieferungen schriftlich anzuzeigen, andernfalls die Lieferung als vorbehaltlos angenommen gilt und auf diesbezügliche Gewährleistungs- und Schadenersatzansprüche verzichtet wird. Der Mangel ist nach Art und Umfang so deutlich zu kennzeichnen, dass wir den Grund der Beanstandung deutlich erkennen können. Der Besteller ist verpflichtet, für die einstweilige Aufbewahrung der beanstandeten

Ware zu sorgen. Im Übrigen haften wir für Mängel der Lieferung unter Ausschluss weiterer Ansprüche wie folgt: Alle diejenigen Teile sind unentgeltlich nach unserer Wahl auszubessern oder neu zu liefern, welche innerhalb von sechs Monaten, ab Lieferdatum gerechnet, nachweisbar infolge eines vor dem Gefahrübergang liegenden Umstandes, insbesondere wegen fehlerhafter Bauart, schlechter Stoffe oder mangelhafter Ausführung unbrauchbar werden bzw deren Brauchbarkeit erheblich beeinträchtigt wurde. Natürlicher Verschleiß, sachwidrige Behandlung, übermäßige Inanspruchnahme, Nachlässigkeit und Änderungen ohne unsere Genehmigung schließen eine Gewährleistung aus. Gewährleistungsansprüche können nur anerkannt werden, wenn sie unverzüglich nach Feststellung der Fehlerhaftigkeit schriftlich bei uns erhoben werden. Solche Teile müssen uns franko eingesandt werden. Das ersetzte Stück wird bei Ersatzlieferung oder Gutschrift unser Eigentum.

6.2. Außerhalb des Anwendungsbereiches des Produkthaftungsgesetzes beschränkt sich unsere Haftung auf Vorsatz und krass grobe Fahrlässigkeit. Die Haftung für schlicht grobe und leichte Fahrlässigkeit, der Ersatz von Folgeschäden und Vermögensschäden, nicht erzielten Ersparnissen, Zinsverlusten und von Schäden aus Ansprüchen Dritter gegen den Besteller sind ausgeschlossen. Ein Regress nach § 12 PHG gegen uns ist ausgeschlossen.

6.3. Wir haften nur für eigene Inhalte auf der Website unseres Online-Shops. Soweit wir mit Links den Zugang zu anderen Websites ermöglichen, sind wir für die dort enthaltenen fremden Inhalte nicht verantwortlich. Wir machen uns die fremden Inhalte nicht zu Eigen. Sofern wir Kenntnis von rechtswidrigen Inhalten auf externen Websites erhalten, werden wir den Zugang zu diesen Seiten unverzüglich sperren.

**7. Abnahme, Abruf, Rückgabe**

7.1. Auf Abruf gekaufte Ware ist binnen zwölf Monaten ab Bestelldatum abzunehmen. Bei nichtrechtzeitiger Abnahme sind wir berechtigt, die versandfertige Ware auf Kosten und Gefahr des Bestellers einzulagern und unter Belastung aller entstehenden Kosten als geliefert in Rechnung zu stellen. Bei Abnahmeverzug über den genannten zwölfmonatigen Zeitraum hinaus sind wir auf jeden Fall berechtigt, vom Verträge zurückzutreten und unbeschadet weitergehender Ansprüche vom Besteller eine 10%ige Stornogebühr zu begehren.

7.2. Bestellte Ware wird ausnahmslos nicht zurückgenommen. Etwaige Rücklieferungen werden daher nicht angenommen und auf Kosten und Gefahr des Bestellers zurückgeschickt.

**8. Schutzrechte, Zeichnungen, Muster**

Der Besteller haftet dafür, dass durch seine Vorgaben bzw. durch die Verwendung uns zu Verfügung gestellter Zeichnungen, Muster und sonstiger Ausführungsvorschriften Schutzrechte Dritter, insbesondere Marken-, Muster-, Patent- und Urheberrechte, nicht verletzt werden. Der Besteller ist verpflichtet uns diesbezüglich schad- und klaglos zu halten. Für den Verlust oder die Beschädigung von zur Verfügung gestellter Unterlagen wird keine Haftung übernommen. Eine diesbezügliche Versicherung wird nur über ausdrücklichen Auftrag und auf Kosten des Bestellers abgeschlossen.

**9. Datenschutz**

9.1. Mit unserer „Datenschutzinformation“ unterrichten wir unsere Kunden über: Art, Umfang und Zweck der Erhebung, Verarbeitung und Nutzung der für die Ausführung von Bestellungen sowie Abrechnungen erforderlichen personenbezogenen Daten; sein Widerspruchsrecht zur Erstellung und Verwendung seines anonymisierten Nutzungsprofils für Zwecke der Werbung und zur bedarfsgerechten Gestaltung unseres Angebotes; die Weitergabe von Daten an von uns beauftragte und zur Beachtung der gesetzlichen Datenschutzbestimmungen verpflichtete Unternehmen zum Zwecke und für die Dauer der Bonitätsprüfung sowie der Versendung der Ware; das Recht auf unentgeltliche Auskunft seiner bei uns gespeicherten personenbezogenen Daten; das Recht auf Berichtigung, Löschung und Sperrung seiner bei uns gespeicherten personenbezogenen Daten; Jede über Ziff. 1 hinausgehende Erhebung, Verarbeitung und Nutzung der personenbezogenen Daten bedarf der Einwilligung des Kunden. Der Kunde hat die Möglichkeit, diese Einwilligung vor Erklärung seiner Bestellung zu erteilen. Dem Kunden steht das Recht auf jederzeitigen Widerruf der Einwilligung mit der Wirkung für die Zukunft zu (siehe „Datenschutzrechtliche Einwilligung“).

**10. Allgemeines, Erfüllungsort, Gerichtsstand, Rechtswahl**

10.1. Rechtliche Unwirksamkeit eines Teiles dieser Verkaufs- und Lieferbedingungen berührt die Gültigkeit der übrigen Bestimmungen nicht. Maßgeblich ist jeweils die zum Zeitpunkt der Vertragschließung gültige Fassung der AGB.

10.2. Erfüllungsort für Lieferung und Zahlung ist ausschließlich A 5412 Puch bei Hallein, sofern sich aus der Auftragsbestätigung nichts anderes ergibt.

10.3. Salzburg ist ausschließlicher Gerichtsstand bei allen sich aus diesem Vertragsverhältnis mittelbar oder unmittelbar ergebenden Streitigkeiten.

10.4. Diese AGB und die unter diesen AGB abzuschließenden Verträge unterliegen österreichischem materiellem Recht unter Ausschluss der Verweisungsnormen und des UN-Kaufrechts (CISG).

10.5. Zwingende Rechte eines Verbrauchers nach dem Konsumentenschutzgesetz werden durch die vorgenannten Bedingungen nicht eingeschränkt.

## E General sales conditions

### 1. Quotation, order, price

1.1. The following sales and supply terms & conditions apply to all contracts concluded with us. Any rival terms & conditions are only binding on us if they are acknowledged by us in writing. This also applies in the event that a customer refers to its own purchasing terms & conditions. Oral agreements that contain an additional obligation upon us are only binding if they are confirmed by us in writing.

1.2. Our prices are subject to amendment. The measurements given in the pricelist correspond with the relevant applicable standards and will be amended in line with a change in the standard measurements.

1.3. Our prices are deemed to be ex works and to exclude the statutory Value Added Tax. Packaging, freight and transportation insurance costs are borne by the customer.

1.4. If goods are ordered by electronic means, we will confirm access to the customer's order without delay. Confirmation of access does not yet represent a binding declaration of acceptance of the order unless we expressly declare this. With goods ordered by electronic means we are entitled to accept the order within three working days of its receipt by us.

### 2. Payment terms, payment conditions, withdrawal

2.1. Our invoices are due for payment 30 days net following the invoice date without deduction. The purchase price is due immediately if the customer falls into arrears with us with other payment obligations. If the payment terms are exceeded, subject to a claim for further losses due to delayed payment, 12% interest on arrears will be charged from the due date until the date of payment.

2.2. The customer has a right of setoff only if its claims have been determined by action of law or acknowledged by us.

2.3. If the customer remains in arrears for longer than 30 days, if it is subject to distraints or attachments or if its asset situation deteriorates considerably, we are entitled to withdraw from all supply contracts not yet fulfilled or to demand payment in advance.

### 3. Delivery

3.1. Part deliveries are permitted.

3.2. We make every effort to meet delivery times as exactly as possible. Delivery times are not binding. If the end of the delivery time falls within the period of the company holiday, the delivery time is extended by the duration of the company holiday. In any event, compensation claims or cancellation of the contract as a result of delayed delivery are excluded if they cannot be attributed to our severe gross negligence.

### 4. Transfer of risk

Dispatch is always at the customer's expense and risk. We are not liable for damage or losses in transit. In the absence of special dispatch instructions by the customer, we can make the dispatch by what we consider to be the best means. If the customer does not give any contrary instructions regarding insurance against damage in transit, this may be arranged by us at the customer's expense without further consent. However, we are not obliged to provide insurance cover.

### 5. Reservation of title

Regardless of the earlier transfer of risk, the goods delivered remain our property until full payment of all the customer's liabilities arising from the supply contract. As long as the goods are our property, the customer is not entitled to pledge the goods or assign them as security to a third party. If a third party threatens our property, we are to be informed of this without delay. If a bailiff intends to distraint the goods delivered, our ownership claims are to be put forward to the bailiff, quoting the name and address of our company. The customer must compensate us for all losses and costs that arise from breach of these obligations and for the intervention measures necessary against third party claims on the goods.

### 6. Guarantee, limitation of liability and release from liability

6.1. The customer must thoroughly inspect any delivery immediately upon receipt. Complaints about incomplete delivery or arising from defects discovered are to be reported in writing within 8 days following receipt of the individual deliveries, otherwise the delivery is deemed to be accepted without reservation and claims for these under the guarantee or for damage/losses are waived. The defect is to be clearly indicated as to its nature and extent so that we can clearly identify the basis of the complaint. The customer is obliged to look after the temporary storage of the goods complained about. In addition, we are liable for defects in the delivery with the exclusion of other claims, as follows: We may choose either to repair or replace free of charge all such parts that evidently become unusable or whose usability has been significantly affected as a result of a circumstance prevailing before the transfer of risk, in particular as a result of defective design, poor materials or defective work within six months counting from the delivery date. Normal wear and tear, incorrect treatment, excessive use, neglect and changes without our consent invalidate the guarantee. Guarantee claims can only be recognised if they are made to us in writing without delay after discovery of the fault. Such parts must be sent to us carriage paid. The replaced part becomes our property upon replacement delivery or issue of a credit note.

6.2. Outside the area of applicability of the Produkthaftungsgesetz (PHG, Product Liability Act) our liability is limited to deliberate act and severe gross negligence. Our liability for simple gross negligence and slight negligence, compensation for consequential loss and damage to property, savings not achieved, loss of interest and for losses arising from third party claims against the customer are excluded. Redress against us in accordance with § 12 PHG is excluded.

6.3. We are liable only for our own content on the website of our online shop. In so far as we provide access to other websites with links, we are not liable for the third party content contained therein. We do not adopt the third party content. If we become aware of illegal content on external websites, we will block access to these sites without delay.

**7. Acceptance, call-off, return**

7.1. Goods purchased on call-off are to be accepted within twelve months of the order date. In the event of them not being accepted on time, we are entitled to store the goods ready for dispatch at the customer's expense and risk and to invoice for them as if delivered including all costs incurred. In the event of delay in acceptance beyond the above-mentioned twelve-month period, we are in any event entitled to withdraw from the contract and to demand a 10% cancellation fee from the customer without prejudice to further claims.

7.2. Without exception, goods ordered are not taken back. Therefore returns are not accepted and they are returned at the customer's expense and risk.

**8. Intellectual property rights, drawings, samples**

The customer is liable for ensuring that the intellectual property rights of third parties, in particular trade mark, sample and patent rights and copyright, are not infringed by its specifications or by the use of drawings, samples and other implementation specifications provided to us. The customer is obliged to indemnify us against any losses or complaints arising from this. No liability is accepted for loss or damage to the documents provided to us. Insurance against this will only be taken out on the customer's express instruction and at its expense.

**9. Data protection**

9.1. With our "Data protection information" we inform our customers about: the nature, extent and purpose of the recording, processing and use of the personal data required for fulfilling orders and invoicing;

his rights to object to the production and use of his anonymised use profile for purposes of advertising and for the design of our product range in line with demand; the passing on of data to companies engaged by us and obliged to observe the statutory provisions of data protection for the purpose and duration of the creditworthiness check and the dispatch of the goods; the right to information free of charge regarding his personal data stored by us;

the right to the correction, deletion and blocking of his personal data stored by us;

Any recording, processing or use of the personal data going beyond Point 1 requires the customer's consent. The customer has an option to grant this consent before giving his order. The customer is entitled to withdraw consent at any time with future effect. (See "Data protection law consent").

**10. General, place of fulfilment, place of jurisdiction, choice of law**

10.1. The legal invalidity of a part of these sales and supply terms & conditions does not affect the remaining terms. It is the version of these STCs valid at the date of conclusion of the contract that applies in each case.

10.2. The place of fulfilment for delivery and payment is exclusively

A 5412 Puch bei Hallein, in so far as not stated otherwise on the order confirmation.

10.3. Salzburg is the exclusive place of jurisdiction for all disputes arising directly or indirectly from this contractual relationship.

10.4. These STCs and the contracts to be signed under these STCs are subject to Austrian property law, with the exclusion of the reference provisions of the UN Convention on Contracts for the International Sale of Goods (CISG).

10.5. Consumers' statutory rights under the Konsumentenschutzgesetz (Consumer Protection Act) are not restricted by the above-mentioned terms.

## ES Condiciones de venta y entrega

### 1. Ofertas, pedidos, precios

1.1. Las siguientes condiciones de venta y suministro se aplican a todos los contratos celebrados con la empresa. Solo serán vinculantes otras condiciones si las hemos aceptado por escrito. Esto se aplica igualmente en el caso de que el comprador remita a sus propias condiciones de compra. Los acuerdos verbales que supongan una obligación adicional para nosotros solo serán vinculantes si los hemos confirmado previamente por escrito.

1.2. Precios sin compromiso. Los importes incluidos en la lista de precios corresponden a las normas vigentes y se modificarán de modo correspondiente al cambiar dichas normas.

1.3. Nuestros precios no incluyen el IVA vigente de fábrica. El embalaje, la carga y los costes del seguro de transportes son responsabilidad del comprador.

1.4. Los productos solicitados electrónicamente se confirmarán inmediatamente tras recibir el pedido del cliente. La confirmación de la recepción no supone una declaración vinculante de la aceptación del pedido, a menos que así lo declaramos de forma expresa. En el caso de productos solicitados electrónicamente estamos autorizados a aceptar el pedido transcurridos tres días laborales desde la recepción.

### 2. Periodo de pago, condiciones de pago, renuncia

2.1. El importe neto y sin deducciones de las facturas ha de pagarse en los 30 días posteriores a la fecha de la factura. El precio de venta habrá de abonarse de inmediato si el comprador incurre en demora con otras obligaciones de pago. Al superar el plazo de pago, se cargará un interés por demora del 12 %, salvo en caso de que se hagan efectivos daños por demora adicionales.

2.2. El comprador tiene derecho a una compensación solo si sus reclamaciones son jurídicamente válidas o las hemos reconocido nosotros.

2.3. Si el comprador incurre en demora del pago en más de 30 días, se procederá a iniciar un embargo o si empeora notablemente su situación financiera, tenemos derecho a renunciar a todos los contratos de suministro aún pendientes o a exigir el pago anticipado.

### 3. Suministro

3.1. Es posible realizar suministros parciales.  
3.2. Nos esforzamos por mantener en la medida de lo posible los plazos de suministro. Los plazos de suministro no son vinculantes. Si el final del plazo de suministro coincide en el tiempo con las vacaciones de la empresa, el plazo de suministro se prolonga hasta el final de dichas vacaciones. En todo caso, se excluye el derecho a indemnizaciones o la anulación del contrato debido al retraso en el suministro si no puede demostrarse que se debe a negligencia muy grave por nuestra parte.

### 4. Cesión de riesgos

El envío se realiza siempre por cuenta y riesgo del comprador. No nos hacemos responsables de los daños y las pérdidas causadas por el transporte. La ausencia de instrucciones especiales de envío por parte del comprador causa que hagamos el envío según nuestro mejor parecer. Si el comprador no da ninguna instrucción en relación con el seguro para los daños originados durante el transporte, nos reservamos el derecho de transferirlo al comprador sin previo aviso. No obstante, no estamos obligados a contratar ningún seguro.

### 5. Reserva de propiedad

La mercancía entregada sigue siendo de nuestra propiedad hasta el pago completo de todas las obligaciones originadas por el contrato de suministro, independientemente de la cesión de riesgos anterior. Mientras la mercancía sea de nuestra propiedad, el comprador no tiene derecho a darla en prenda a terceros o transferirla como garantía. Si un tercero amenaza nuestra propiedad, debemos ser informados de inmediato. Si un agente judicial pretende embargar la mercancía suministrada, habrá de indicarse al agente judicial la propiedad y mencionar la empresa y la dirección. El comprador deberá abonarnos todos los daños y costes que se han originado por la vulneración de estas obligaciones y las medidas necesarias contra el acceso de terceros a la mercancía.

### 6. Garantía, limitación de responsabilidad y exención de responsabilidad

6.1. El comprador debe comprobar de inmediato el suministro tras su recepción. Las reclamaciones por la omisión de productos en el envío o deficiencias en los productos han de comunicarse por escrito en un periodo de 8 días tras la recepción de cada suministro; en caso contrario, se considera que el suministro se ha recibido correctamente y que se renuncia a cualquier reclamación de la garantía y derecho al pago de indemnizaciones. El tipo y el alcance de las deficiencias han de describirse claramente, de forma que podamos reconocer con facilidad el motivo de la reclamación. El comprador está obligado a almacenar temporalmente la mercancía objeto de la reclamación. Asimismo somos responsables de las deficiencias del suministro excluyendo los derechos siguientes: nosotros decidimos si es preciso reparar o sustituir las piezas que, en un plazo de seis meses a partir de la fecha de entrega, no puedan usarse o su uso haya resultado mermado notablemente y de forma evidente como consecuencia de una situación previa a la cesión de riesgos, en especial debido a un diseño defectuoso, materiales deficientes o fabricación incorrecta. El desgaste natural, el manejo inadecuado, el uso excesivo, la negligencia y la ejecución de modificaciones sin nuestra autorización son causa de anulación de la garantía. Solo se reconocerán los derechos de garantía si se nos ha comunicado por escrito inmediatamente después de haber detectado la deficiencia. Dichas piezas han de enviarse con los portes pagados. La pieza sustituida es de nuestra propiedad tras el envío de sustitución o tras realizar un abono en cuenta.

6.2. Fuera del ámbito de aplicación de la ley austriaca de responsabilidad por productos defectuosos, nuestra responsabilidad se limita a la culpa intencional y la culpa muy grave. No se incluye la responsabilidad por culpa grave y leve, la indemnización por daños directos y daños patrimoniales, ahorros no logrados, pérdida de intereses y daños por reclamaciones de terceros al comprador. Según el art. 12 de la ley austriaca de responsabilidad por productos defectuosos se excluyen los recursos a la empresa.

6.3. Solo nos hacemos responsables de los contenidos propios del sitio web de nuestra tienda en línea. Aunque facilitamos el acceso mediante enlaces a otros sitios web, no nos hacemos responsables del contenido ajeno de dichos sitios. No tenemos la propiedad de los contenidos ajenos. En el momento en el que tengamos conocimiento de contenidos ilegales en sitios web externos, bloquearemos de inmediato el acceso a estas páginas.

**7. Aceptación, reclamación de la entrega, devolución**

7.1. La mercancía adquirida a demanda debe aceptarse en un plazo de 12 meses a partir de la fecha del pedido. Si no se acepta en este plazo de tiempo, tenemos derecho a almacenar la mercancía lista para enviar por cuenta y riesgo del comprador y facturarla como si se hubiera entregado, incluyendo todos los costes derivados. En el caso de demora en la aceptación, transcurridos los doce meses antes mencionados, tenemos derecho a desistir del contrato y a demandar al comprador una tasa de cancelación del 10 % sin perjuicio de otras reclamaciones.

7.2. La mercancía pedida no podrá devolverse en ningún caso. Por dicho motivo no se aceptará ningún envío de devolución y se devolverá al comprador por su cuenta y riesgo.

**8. Derechos de propiedad intelectual, diseños, muestras**

El comprador es responsable de que no se infrinjan los derechos de propiedad intelectual de terceros, en especial los derechos de marcas, muestras, patentes y de autor, por sus especificaciones o el uso de diseños, muestras y otras especificaciones de ejecución puestos a nuestra disposición. El comprador está obligado a indemnizarnos por cualquier pérdida o reclamación que se derive. No nos responsabilizamos de la pérdida o el daño de los documentos que se hayan puesto a nuestra disposición. Solo se suscribirá un seguro si el comprador así lo solicita de forma expresa y a sus expensas.

**9. Protección de datos**

9.1. Nuestra "información sobre la protección de datos" ofrece a nuestros clientes más información acerca de:

- El tipo, el alcance y el objeto de la recopilación, el procesamiento y el uso de los datos personales necesarios para la ejecución de pedidos y facturas;
- Su derecho de oposición a la creación y uso de un perfil anónimo para publicidad y la adaptación de nuestra oferta a la demanda;
- La transmisión de datos a empresas contratadas por nosotros y obligadas a observar las disposiciones legales de la protección de datos con el objeto y la duración de la verificación de la solvencia, así como el envío de la mercancía;
- El derecho a la información gratuita acerca de sus datos personales guardados;
- El derecho a la rectificación, la eliminación y el bloqueo de los datos personales guardados;
- Es necesaria la autorización del cliente para cualquier recopilación, procesamiento y uso de los datos personales derivados del punto 1. El cliente tiene la posibilidad de conceder esta autorización antes de realizar el pedido. El cliente tiene el derecho de retirar en cualquier momento su autorización con efecto futuro (véase "Autorización conforme con el derecho de protección de datos").

**10. Generalidades, lugar de ejecución, jurisdicción, legislación aplicable**

10.1. La invalidez legal de una parte de estas condiciones de venta y suministro no afecta a la validez de las restantes disposiciones. Se aplica la versión de las condiciones generales de contratación vigente en el momento de la celebración del contrato.

10.2. El lugar de ejecución del suministro y el pago es únicamente A 5412 Puch en Hallein (Austria), a menos que en la confirmación del contrato se indique lo contrario.

10.3. Salzburgo es la única jurisdicción para cualquier disputa que se derive directa o indirectamente de este contrato.

10.4. Estas condiciones y los contratos celebrados según estas condiciones están sujetos al derecho austriaco, con la excepción de las normas de reenvío y la convención de las Naciones Unidas sobre los contratos de compraventa internacional (CISG).

10.5. Los derechos preceptivos de los consumidores según la ley de protección de consumidores no quedan limitados por las condiciones antes mencionadas.









Art.Nr: 0099900123100

Überreicht durch:  
*With the compliments of:*  
*Recomendado por:*

#### ÖSTERREICH

##### ALPEN-MAYKESTAG GmbH

Urstein Nord 67 | A-5412 Puch / Salzburg  
Tel: +43 (0) 662 449 01-0  
Fax: +43 (0) 662 449 01-110  
Fax Export: +43 (0) 662 449 01-130  
verkauf@a-mk.com  
export@a-mk.com

#### DEUTSCHLAND

##### ALPEN-MAYKESTAG GmbH

Dechenstraße 15A | D-40878 Ratingen  
Tel: +43 (0) 662 449 01-0  
verkauf@a-mk.com

#### ITALIA

##### ALPEN-MAYKESTAG s.r.l.

Via Volontari Del Sangue 54 | I-20093 Cologno Monzese (MI)  
Tel: +39 (02) 48 84 30 38  
Fax: +39 (02) 45 70 14 19  
info@a-mk.it

#### ČESKÁ REPUBLIKA

##### ALPEN-MAYKESTAG s.r.o.

U Koruny 414 | CZ-50002 Hradec Králové  
Tel. +420 495 58 23 22  
Fax +420 495 58 23 25  
info@a-mk.cz

#### MAGYARORSZÁG

##### ALPEN-MAYKESTAG Kft.

Gyár utca 5 | H-8500 Pápa  
Tel. +36 (0) 89 511515  
Fax +36 (0) 89 511516  
info@a-mk.hu

[www.alpen-drills.com](http://www.alpen-drills.com)

  
**alpen** *drill better.*

## X-ON Electronics

Largest Supplier of Electrical and Electronic Components

*Click to view similar products for [Other Tools](#) category:*

*Click to view products by [Alpen-Maykestag](#) manufacturer:*

Other Similar products are found below :

[899-2-KT46](#) [CR-0AFL4--332K](#) [568681-1](#) [5800-0090](#) [58061-1](#) [59085](#) [00-8273-RDPP](#) [593033](#) [593072](#) [593564100](#) [593575](#) [593593](#) [010-0003-0000](#) [011349-000](#) [CRCW08052740FRT1](#) [LUC-012S070DSM](#) [LUC-018S070DSP](#) [LUC-024S105DSP](#) [599-2021-3-NME](#) [599-JJ-2021-03](#) [CRCW2010331JR02](#) [601-JJ-06](#) [601-SPB](#) [601YSY](#) [602-JJ-03](#) [602SPB](#) [603-JJ-07-FP](#) [603-JJY-04](#) [CRTN1013](#) [CS16](#) [6-1579014-0](#) [62036240-1](#) [M43435 TY 1 SZ 3 FIN B BLK](#) [M43435 TY 2 SZ 3 FIN C BLK](#) [M43435 TY 5 SZ 3 FIN C NAT](#) [M-5Z](#) [M6816](#) [660-29ABT1](#) [662508-1](#) [CVHD-950X-93.333](#) [CW104-01X](#) [671-GP-04-KT39-73207](#) [CW307-01A](#) [CW30901A](#) [CW6211201A](#) [690191-1](#) [690191-3](#) [690317-2](#) [691409-4](#)