

General Description

- Trench Power MOSFET technology
- Low $R_{DS(ON)}$
- RoHS and Halogen-Free Compliant

Applications

- DC/DC Converters in Computing, Servers, and POL
- Battery protection switch

Product Summary

V_{DS}	20V
I_D (at $V_{GS}=4.5V$)	20A
$R_{DS(ON)}$ (at $V_{GS}=4.5V$)	< 5.9m Ω
$R_{DS(ON)}$ (at $V_{GS}=2.5V$)	< 7.3m Ω

100% UIS Tested
 100% Rg Tested

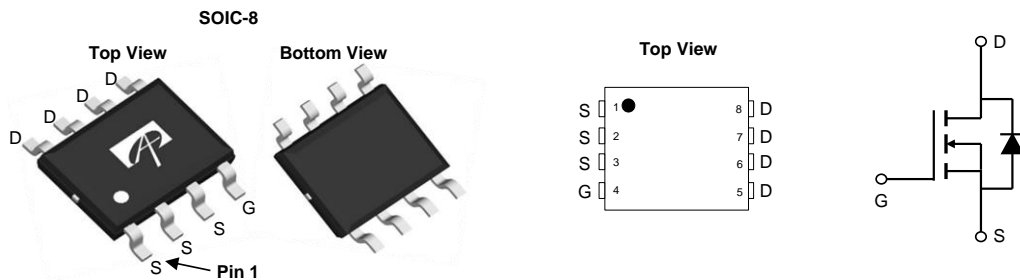

Orderable Part Number	Package Type	Form	Minimum Order Quantity
AO4402G	SO-8	Tape & Reel	3000

Absolute Maximum Ratings $T_A=25^\circ C$ unless otherwise noted

Parameter	Symbol	Maximum	Units
Drain-Source Voltage	V_{DS}	20	V
Gate-Source Voltage	V_{GS}	± 12	V
Continuous Drain Current	I_D	$T_A=25^\circ C$	A
		$T_A=70^\circ C$	
Pulsed Drain Current ^C	I_{DM}	80	
Avalanche Current ^C	I_{AS}	40	A
Avalanche energy $L=0.1mH$ ^C	E_{AS}	80	mJ
Power Dissipation ^B	P_D	$T_A=25^\circ C$	W
		$T_A=70^\circ C$	
Junction and Storage Temperature Range	T_J, T_{STG}	-55 to 150	$^\circ C$

Thermal Characteristics

Parameter	Symbol	Typ	Max	Units
Maximum Junction-to-Ambient ^A	$R_{\theta JA}$	31	40	$^\circ C/W$
Maximum Junction-to-Ambient ^{A,D}		59	75	
Maximum Junction-to-Lead	$R_{\theta JL}$	16	24	$^\circ C/W$

Electrical Characteristics (T_J=25°C unless otherwise noted)

Symbol	Parameter	Conditions	Min	Typ	Max	Units
STATIC PARAMETERS						
BV _{DSS}	Drain-Source Breakdown Voltage	I _D =250μA, V _{GS} =0V	20			V
I _{DSS}	Zero Gate Voltage Drain Current	V _{DS} =20V, V _{GS} =0V T _J =55°C			1 5	μA
I _{GSS}	Gate-Body leakage current	V _{DS} =0V, V _{GS} =±12V			±100	nA
V _{GS(th)}	Gate Threshold Voltage	V _{DS} =V _{GS} , I _D =250μA	0.45	0.85	1.25	V
R _{DS(on)}	Static Drain-Source On-Resistance	V _{GS} =4.5V, I _D =20A T _J =125°C		4.9	5.9	mΩ
		V _{GS} =2.5V, I _D =18A		6.3	7.6	
g _{FS}	Forward Transconductance	V _{DS} =5V, I _D =20A		100		S
V _{SD}	Diode Forward Voltage	I _S =1A, V _{GS} =0V		0.6	1	V
I _S	Maximum Body-Diode Continuous Current				5	A
DYNAMIC PARAMETERS						
C _{iss}	Input Capacitance	V _{GS} =0V, V _{DS} =10V, f=1MHz		3300		pF
C _{oss}	Output Capacitance			485		pF
C _{rss}	Reverse Transfer Capacitance			370		pF
R _g	Gate resistance	f=1MHz	1.2	2.4	3.6	Ω
SWITCHING PARAMETERS						
Q _{g(4.5V)}	Total Gate Charge	V _{GS} =4.5V, V _{DS} =10V, I _D =20A		31	45	nC
Q _{gs}	Gate Source Charge			5.2		nC
Q _{gd}	Gate Drain Charge			8		nC
t _{D(on)}	Turn-On DelayTime	V _{GS} =10V, V _{DS} =10V, R _L =0.5Ω, R _{GEN} =3Ω		7.5		ns
t _r	Turn-On Rise Time			15		ns
t _{D(off)}	Turn-Off DelayTime			72		ns
t _f	Turn-Off Fall Time			21		ns
t _{rr}	Body Diode Reverse Recovery Time	I _F =20A, di/dt=500A/μs		17		ns
Q _{rr}	Body Diode Reverse Recovery Charge	I _F =20A, di/dt=500A/μs		30		nC

- A. The value of R_{θJA} is measured with the device mounted on 1in² FR-4 board with 2oz. Copper, in a still air environment with T_A=25° C. The value in any given application depends on the user's specific board design.
- B. The power dissipation P_D is based on T_{J(MAX)}=150° C, using ≤ 10s junction-to-ambient thermal resistance.
- C. Repetitive rating, pulse width limited by junction temperature T_{J(MAX)}=150° C. Ratings are based on low frequency and duty cycles to keep initial T_J=25° C.
- D. The R_{θJA} is the sum of the thermal impedance from junction to lead R_{θJL} and lead to ambient.
- E. The static characteristics in Figures 1 to 6 are obtained using <300μs pulses, duty cycle 0.5% max.
- F. These curves are based on the junction-to-ambient thermal impedance which is measured with the device mounted on 1in² FR-4 board with 2oz. Copper, assuming a maximum junction temperature of T_{J(MAX)}=150° C. The SOA curve provides a single pulse rating.

APPLICATIONS OR USE AS CRITICAL COMPONENTS IN LIFE SUPPORT DEVICES OR SYSTEMS ARE NOT AUTHORIZED. AOS DOES NOT ASSUME ANY LIABILITY ARISING OUT OF SUCH APPLICATIONS OR USES OF ITS PRODUCTS. AOS RESERVES THE RIGHT TO IMPROVE PRODUCT DESIGN, FUNCTIONS AND RELIABILITY WITHOUT NOTICE.

TYPICAL ELECTRICAL AND THERMAL CHARACTERISTICS

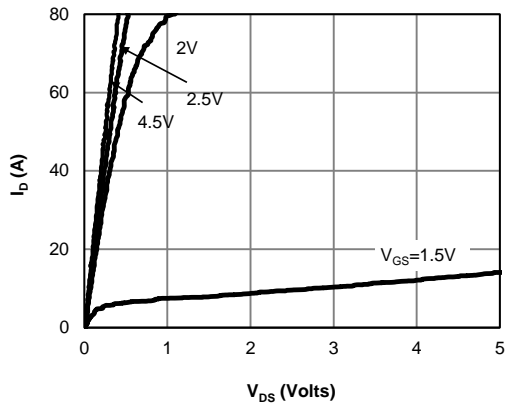

Figure 1: On-Region Characteristics (Note E)

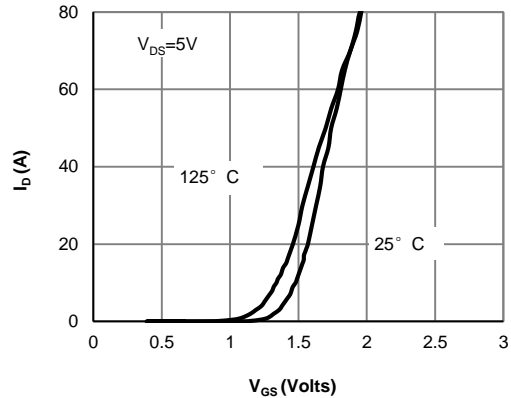

Figure 2: Transfer Characteristics (Note E)

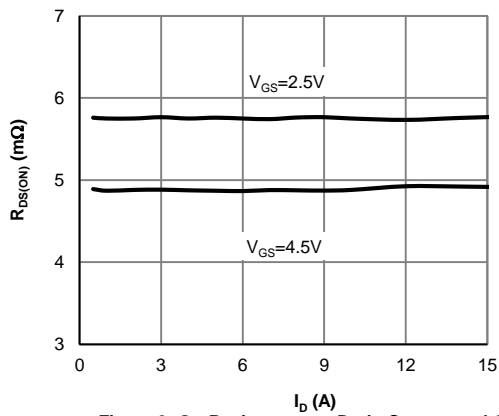

Figure 3: On-Resistance vs. Drain Current and Gate Voltage (Note E)

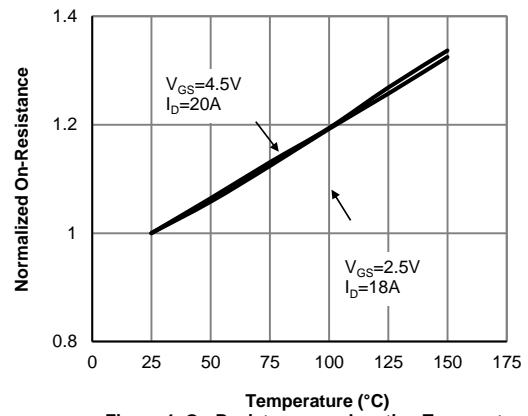

Figure 4: On-Resistance vs. Junction Temperature (Note E)

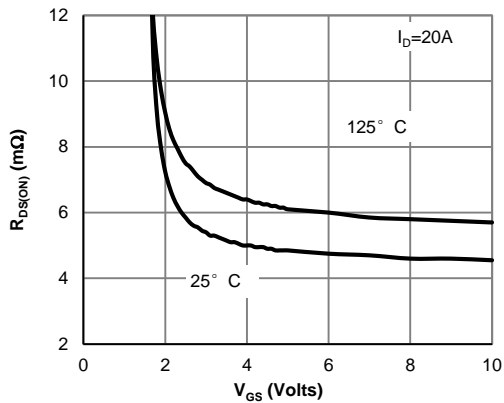

Figure 5: On-Resistance vs. Gate-Source Voltage (Note E)

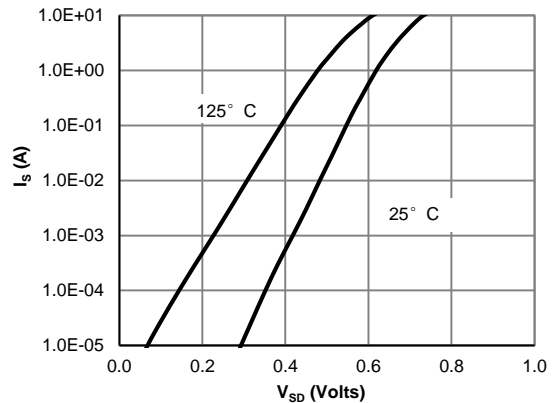

Figure 6: Body-Diode Characteristics (Note E)

TYPICAL ELECTRICAL AND THERMAL CHARACTERISTICS

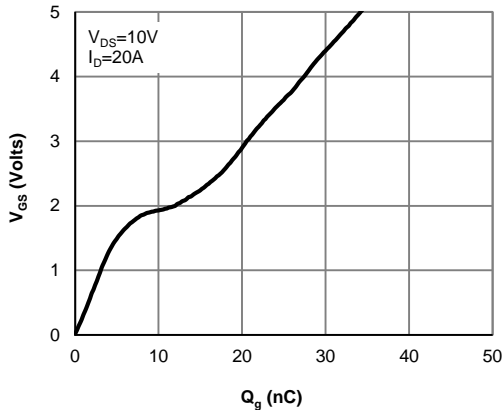

Figure 7: Gate-Charge Characteristics

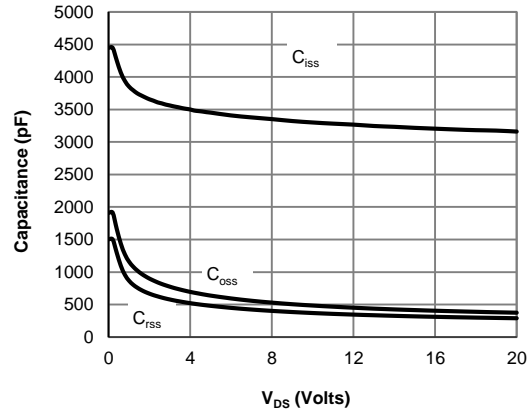

Figure 8: Capacitance Characteristics

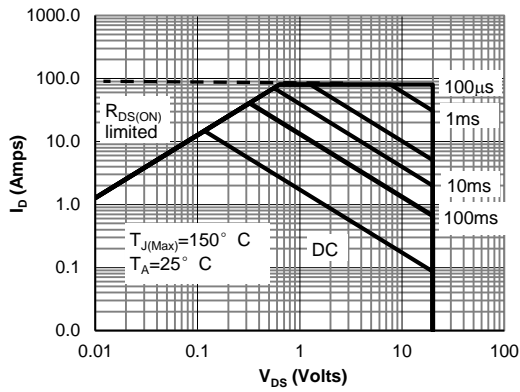

Figure 9: Maximum Forward Biased Safe Operating Area (Note F)

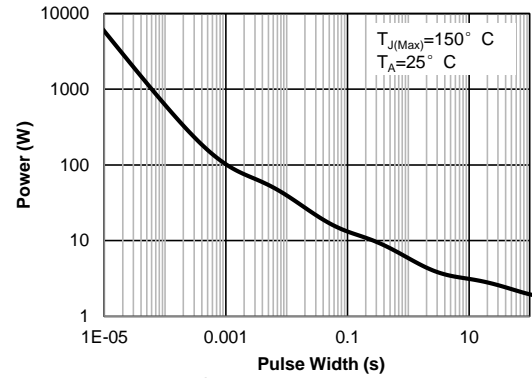

Figure 10: Single Pulse Power Rating Junction-to-Ambient (Note F)

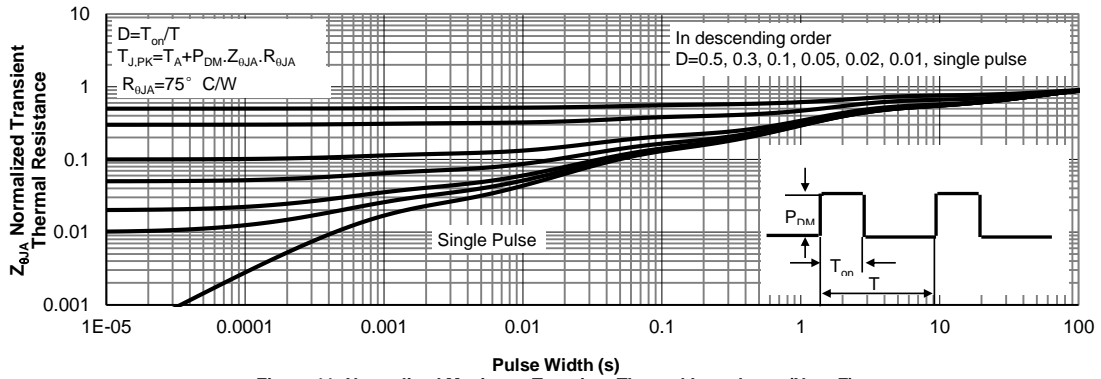

Figure 11: Normalized Maximum Transient Thermal Impedance (Note F)

Figure A: Gate Charge Test Circuit & Waveforms

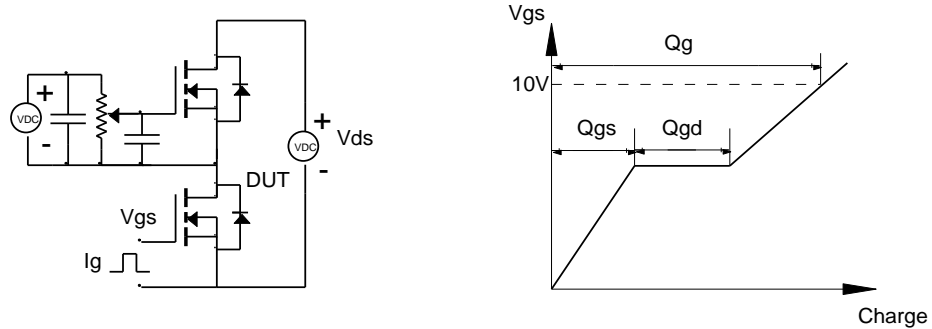

Figure B: Resistive Switching Test Circuit & Waveforms

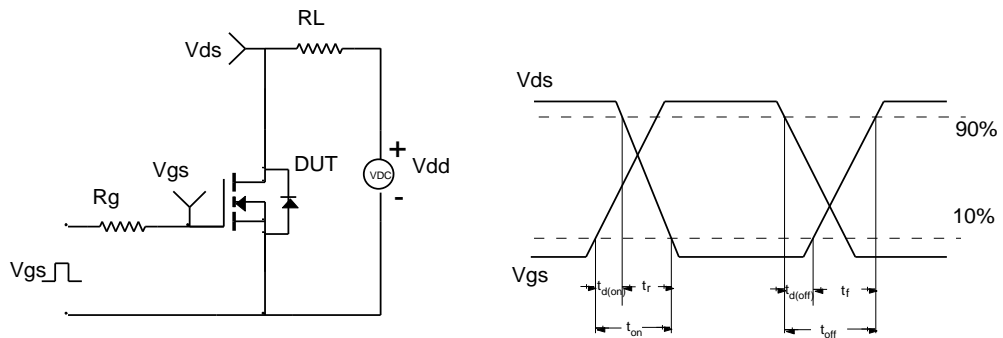

Figure C: Unclamped Inductive Switching (UIS) Test Circuit & Waveforms

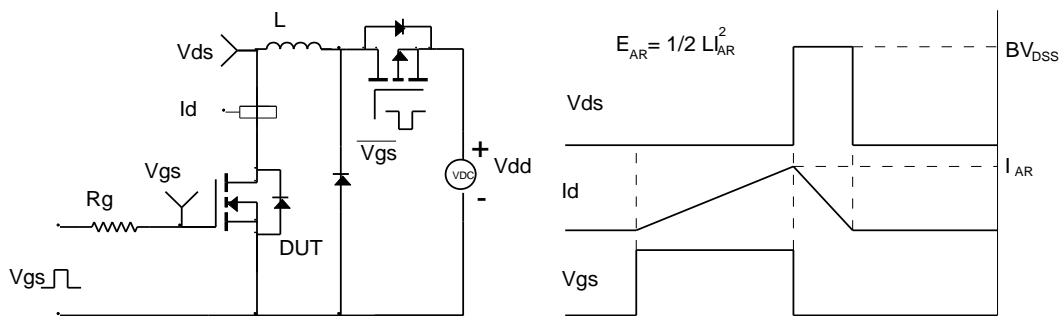
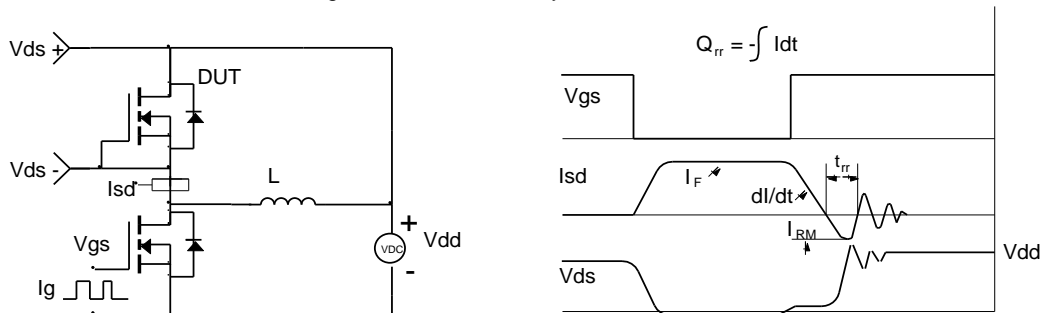

Figure D: Diode Recovery Test Circuit & Waveforms



X-ON Electronics

Largest Supplier of Electrical and Electronic Components

Click to view similar products for [MOSFET](#) category:

Click to view products by [Alpha & Omega](#) manufacturer:

Other Similar products are found below :

[614233C](#) [648584F](#) [FDPF9N50NZ](#) [IRFD120](#) [JANTX2N5237](#) [2N7000](#) [FCA20N60_F109](#) [FDZ595PZ](#) [2SK2545\(Q,T\)](#) [405094E](#) [423220D](#)
[TPCC8103,L1Q\(CM](#) [MIC4420CM-TR](#) [VN1206L](#) [614234A](#) [715780A](#) [NTNS3166NZT5G](#) [SSM6J414TU,LF\(T](#) [751625C](#) [IPP110N20N3GXX](#)
[IPS70R2K0CEAKMA1](#) [DMN3404LQ-7](#) [NTE6400](#) [2SK2614\(TE16L1,Q\)](#) [DMN1017UCP3-7](#) [EFC2J004NUZTDG](#) [ECH8691-TL-W](#)
[FCAB21350L1](#) [P85W28HP2F-7071](#) [DMN1053UCP4-7](#) [NTE221](#) [NTE2384](#) [NTE2903](#) [NTE2941](#) [NTE2945](#) [NTE2946](#) [NTE2960](#) [NTE2969](#)
[NTE2976](#) [NTE455](#) [NTE6400A](#) [NTE2910](#) [NTE2916](#) [NTE2956](#) [NTE2911](#) [TK10A80W,S4X\(S](#) [SSM6P69NU,LF](#) [DMP22D4UFO-7B](#)
[DMN1006UCA6-7](#) [DMN16M9UCA6-7](#)