

General Description

The AO4444 is fabricated with SDMOS™ trench technology that combines excellent $R_{DS(ON)}$ with low gate charge and low Q_{rr} . The result is outstanding efficiency with controlled switching behavior. This universal technology is well suited for PWM, load switching and general purpose applications.

Product Summary

V_{DS}	80V
I_D (at $V_{GS}=10V$)	11A
$R_{DS(ON)}$ (at $V_{GS}=10V$)	< 12m Ω
$R_{DS(ON)}$ (at $V_{GS} = 7V$)	< 14.5m Ω

100% UIS Tested
 100% R_g Tested

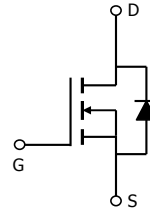
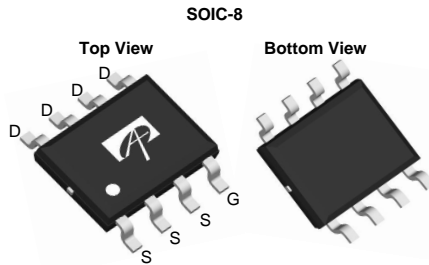

Absolute Maximum Ratings $T_A=25^\circ\text{C}$ unless otherwise noted

Parameter	Symbol	Maximum	Units
Drain-Source Voltage	V_{DS}	80	V
Gate-Source Voltage	V_{GS}	± 25	V
Continuous Drain Current	I_D	$T_A=25^\circ\text{C}$	11
		$T_A=70^\circ\text{C}$	9
Pulsed Drain Current ^C	I_{DM}	80	A
Avalanche Current ^C	I_{AS}, I_{AR}	45	A
Avalanche energy $L=0.1\text{mH}$ ^C	E_{AS}, E_{AR}	101	mJ
Power Dissipation ^B	P_D	$T_A=25^\circ\text{C}$	3.1
		$T_A=70^\circ\text{C}$	2
Junction and Storage Temperature Range	T_J, T_{STG}	-55 to 150	$^\circ\text{C}$

Thermal Characteristics

Parameter	Symbol	Typ	Max	Units
Maximum Junction-to-Ambient ^A	$R_{\theta JA}$	31	40	$^\circ\text{C/W}$
Maximum Junction-to-Ambient ^{A D}		59	75	$^\circ\text{C/W}$
Maximum Junction-to-Lead	$R_{\theta JL}$	16	24	$^\circ\text{C/W}$

Electrical Characteristics (T_J=25°C unless otherwise noted)

Symbol	Parameter	Conditions	Min	Typ	Max	Units
STATIC PARAMETERS						
BV _{DSS}	Drain-Source Breakdown Voltage	I _D =250μA, V _{GS} =0V	80			V
I _{DSS}	Zero Gate Voltage Drain Current	V _{DS} =80V, V _{GS} =0V T _J =55°C			10 50	μA
I _{GSS}	Gate-Body leakage current	V _{DS} =0V, V _{GS} = ±25V			100	nA
V _{GS(th)}	Gate Threshold Voltage	V _{DS} =V _{GS} I _D =250μA	2.6	3	3.8	V
I _{D(ON)}	On state drain current	V _{GS} =10V, V _{DS} =5V	80			A
R _{DS(ON)}	Static Drain-Source On-Resistance	V _{GS} =10V, I _D =11A T _J =125°C		10 18	12 22	mΩ
		V _{GS} =7V, I _D =10A		11.6	14.5	
g _{FS}	Forward Transconductance	V _{DS} =5V, I _D =11A		32		S
V _{SD}	Diode Forward Voltage	I _S =1A, V _{GS} =0V		0.7	1	V
I _S	Maximum Body-Diode Continuous Current				4.5	A
DYNAMIC PARAMETERS						
C _{iss}	Input Capacitance	V _{GS} =0V, V _{DS} =40V, f=1MHz	1900	2386	2865	pF
C _{oss}	Output Capacitance		190	276	360	
C _{riss}	Reverse Transfer Capacitance		60	100	140	
R _g	Gate resistance	V _{GS} =0V, V _{DS} =0V, f=1MHz	0.4	0.8	1.2	Ω
SWITCHING PARAMETERS						
Q _{g(10V)}	Total Gate Charge	V _{GS} =10V, V _{DS} =40V, I _D =11A	30	38	46	nC
Q _{gs}	Gate Source Charge		10	13	16	
Q _{gd}	Gate Drain Charge		6	10	14	
t _{D(on)}	Turn-On DelayTime	V _{GS} =10V, V _{DS} =40V, R _L =3.64Ω, R _{GEN} =3Ω		13		ns
t _r	Turn-On Rise Time			9		
t _{D(off)}	Turn-Off DelayTime			23		
t _f	Turn-Off Fall Time			5		
t _{rr}	Body Diode Reverse Recovery Time	I _F =11A, di/dt=500A/μs	12	18	24	ns
Q _{rr}	Body Diode Reverse Recovery Charge	I _F =11A, di/dt=500A/μs	45	65	85	nC

A. The value of R_{θJA} is measured with the device mounted on 1in² FR-4 board with 2oz. Copper, in a still air environment with T_A=25°C. The value in any given application depends on the user's specific board design.

B. The power dissipation P_D is based on T_{J(MAX)}=150°C, using ≤ 10s junction-to-ambient thermal resistance.

C. Repetitive rating, pulse width limited by junction temperature T_{J(MAX)}=150°C. Ratings are based on low frequency and duty cycles to keep initial T_J=25°C.

D. The R_{θJA} is the sum of the thermal impedance from junction to lead R_{θJL} and lead to ambient.

E. The static characteristics in Figures 1 to 6 are obtained using <300μs pulses, duty cycle 0.5% max.

F. These curves are based on the junction-to-ambient thermal impedance which is measured with the device mounted on 1in² FR-4 board with 2oz. Copper, assuming a maximum junction temperature of T_{J(MAX)}=150°C. The SOA curve provides a single pulse rating.

THIS PRODUCT HAS BEEN DESIGNED AND QUALIFIED FOR THE CONSUMER MARKET. APPLICATIONS OR USES AS CRITICAL COMPONENTS IN LIFE SUPPORT DEVICES OR SYSTEMS ARE NOT AUTHORIZED. AOS DOES NOT ASSUME ANY LIABILITY ARISING OUT OF SUCH APPLICATIONS OR USES OF ITS PRODUCTS. AOS RESERVES THE RIGHT TO IMPROVE PRODUCT DESIGN, FUNCTIONS AND RELIABILITY WITHOUT NOTICE.

TYPICAL ELECTRICAL AND THERMAL CHARACTERISTICS

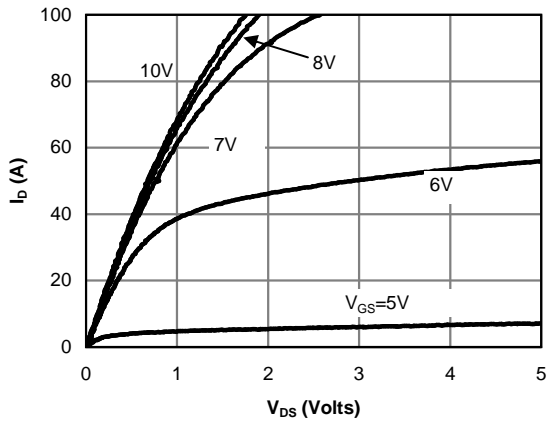

Fig 1: On-Region Characteristics (Note E)

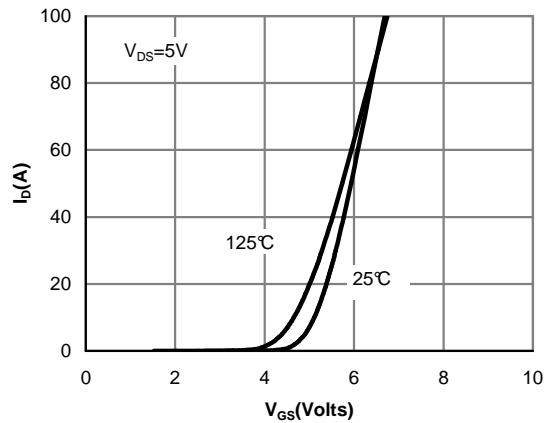

Figure 2: Transfer Characteristics (Note E)

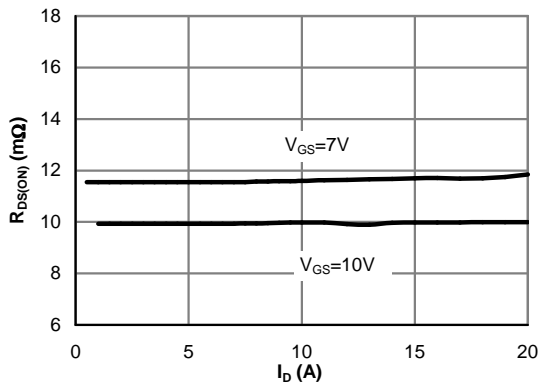

Figure 3: On-Resistance vs. Drain Current and Gate Voltage (Note E)

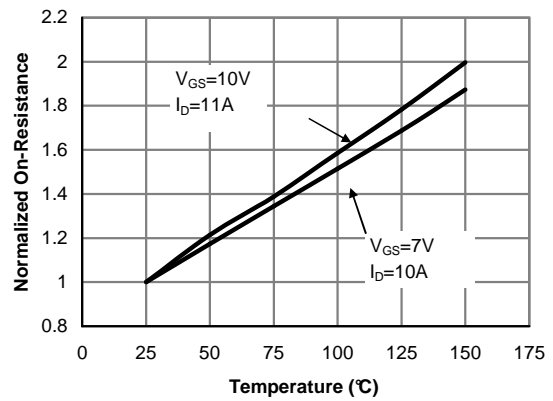

Figure 4: On-Resistance vs. Junction Temperature (Note E)

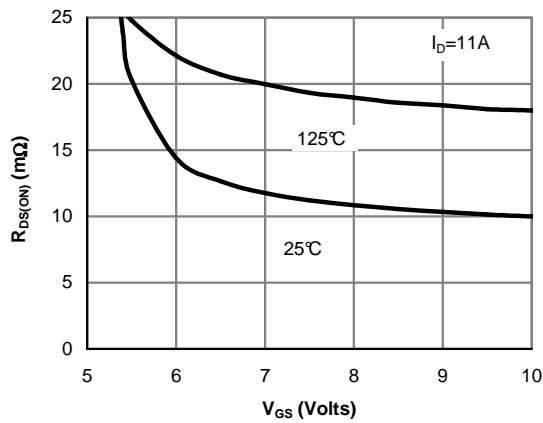

Figure 5: On-Resistance vs. Gate-Source Voltage (Note E)

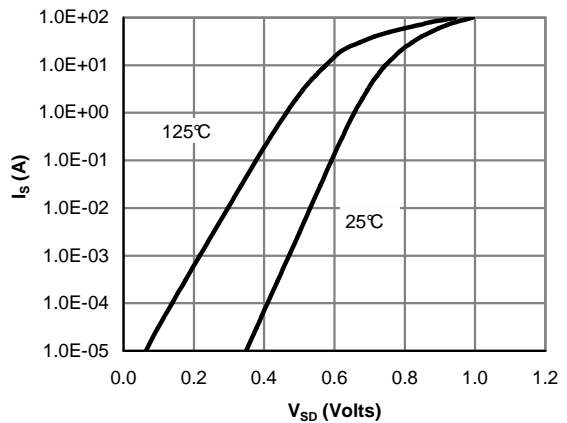

Figure 6: Body-Diode Characteristics (Note E)

TYPICAL ELECTRICAL AND THERMAL CHARACTERISTICS

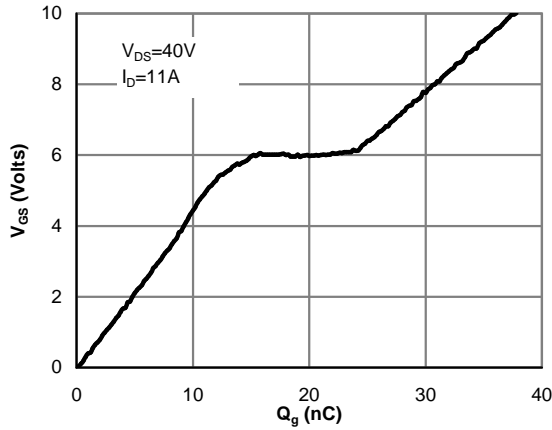

Figure 7: Gate-Charge Characteristics

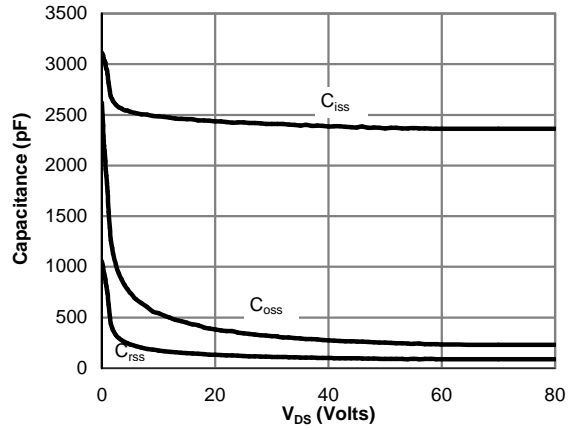

Figure 8: Capacitance Characteristics

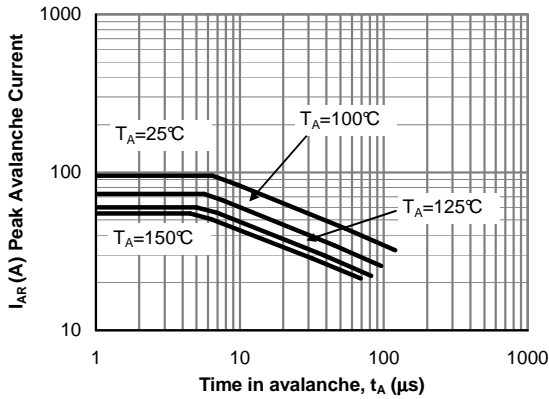

Figure 9: Single Pulse Avalanche capability (Note C)

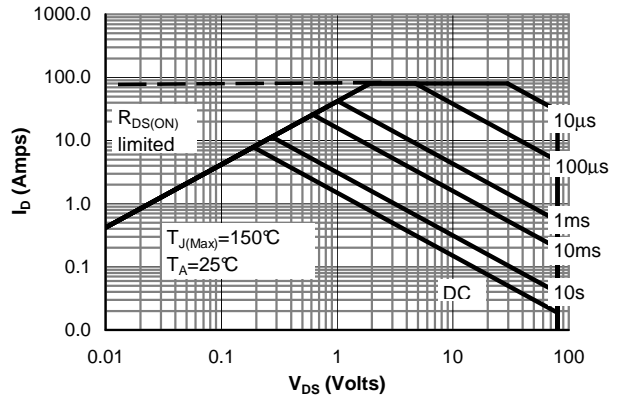

Figure 10: Maximum Forward Biased Safe Operating Area (Note F)

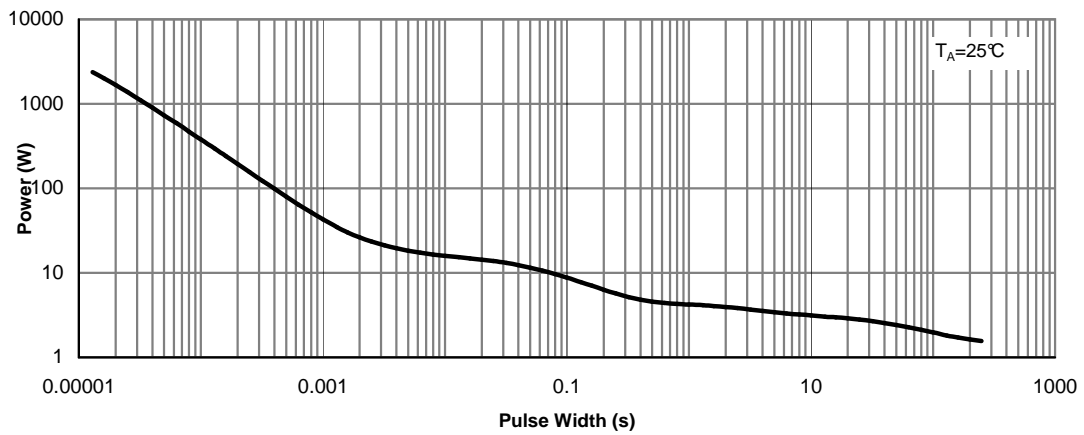

Figure 11: Single Pulse Power Rating Junction-to-Ambient (Note F)

TYPICAL ELECTRICAL AND THERMAL CHARACTERISTICS

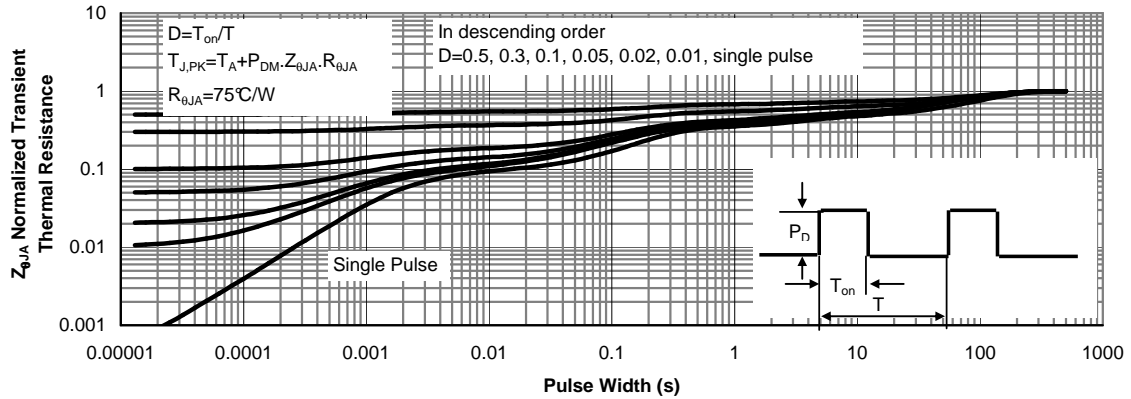

Figure 12: Normalized Maximum Transient Thermal Impedance (Note F)

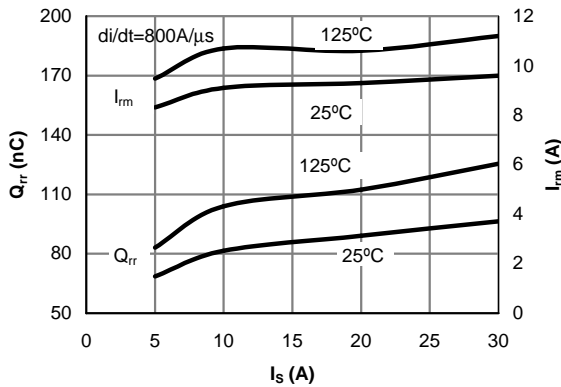

Figure 13: Diode Reverse Recovery Charge and Peak Current vs. Conduction Current

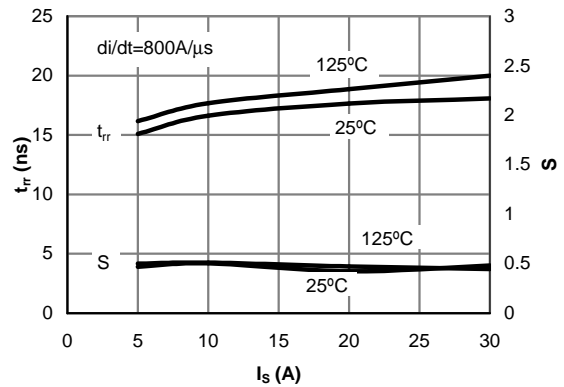

Figure 14: Diode Reverse Recovery Time and Softness Factor vs. Conduction Current

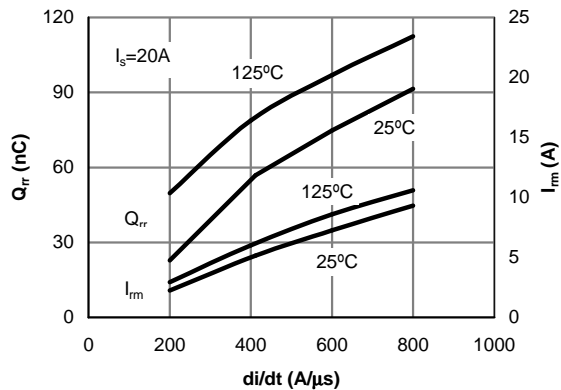

Figure 15: Diode Reverse Recovery Charge and Peak Current vs. di/dt

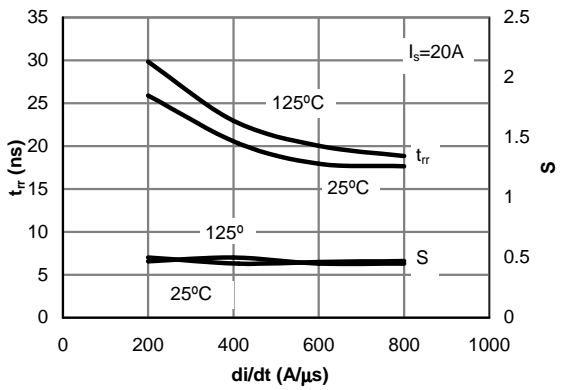
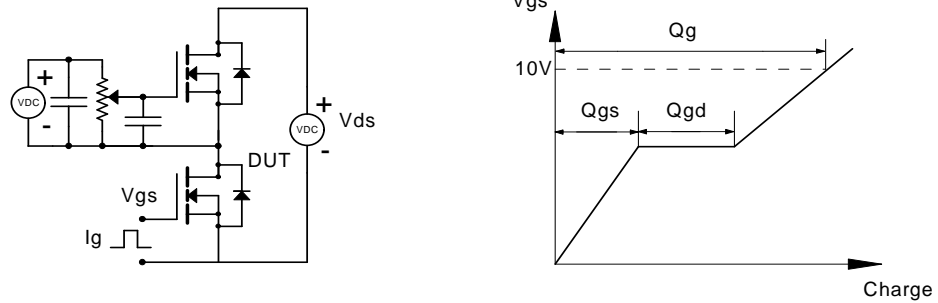
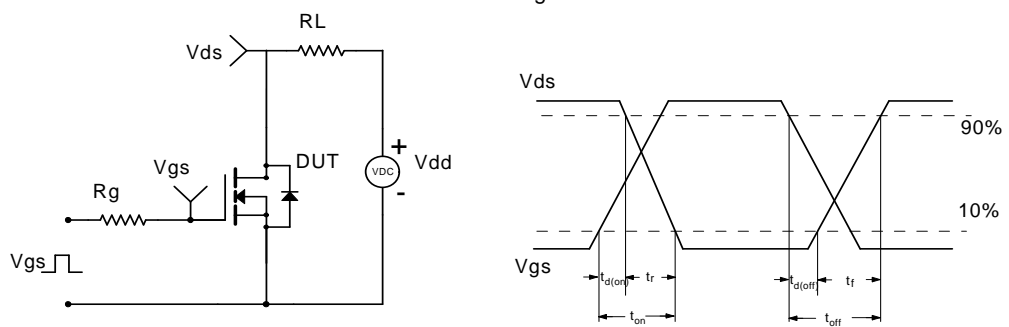

Figure 16: Diode Reverse Recovery Time and Softness Factor vs. di/dt

Gate Charge Test Circuit & Waveform



Resistive Switching Test Circuit & Waveforms



Unclamped Inductive Switching (UIS) Test Circuit & Waveforms

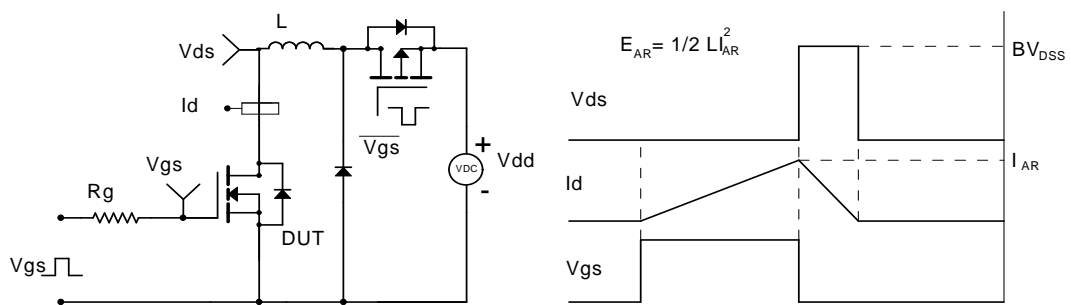

Diode Recovery Test Circuit & Waveforms

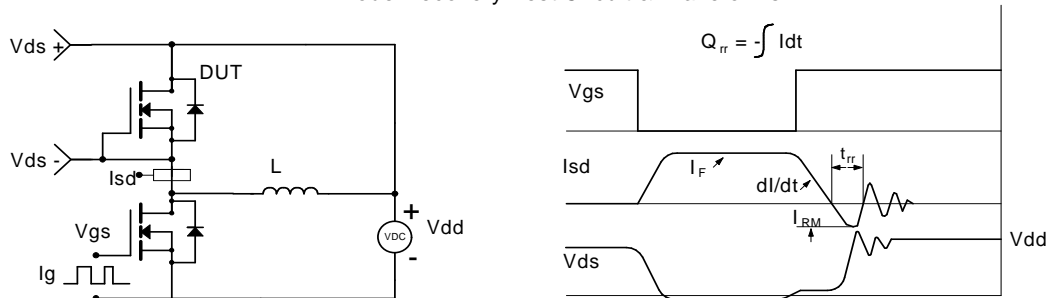

X-ON Electronics

Largest Supplier of Electrical and Electronic Components

Click to view similar products for [alpha & omega manufacturer:](#)

Other Similar products are found below :

[AOT1608L](#) [AO4492](#) [AOD478](#) [AOD468](#) [AOZ6135HI](#) [AO5404E](#) [AOD482](#) [AO3402](#) [AOTF10B60D](#) [AOU3N50](#) [AOZ1235QI-01](#)
[AOK42S60L](#) [AON7534](#) [AOD3N50](#) [AO4468](#) [AO3401A](#) [AO3415](#) [AON2403](#) [AOD4130](#) [AOB290L](#) [AOTF42S60L](#) [AOTF190A60L](#)
[AO4404B](#) [AON6756](#) [AO4813](#) [AO3414](#) [aot412](#) [AO4818](#) [AOT270AL](#) [AO6420](#) [AO3442](#) [AOT2918L](#) [AO4616](#) [AO4294](#) [AOZ1020AI](#)
[AON6250](#) [AON6444](#) [AOZ3011PI](#) [AO8820](#) [AOT10N65](#) [AOK20S60L](#) [AOK20N60L](#) [AON6548](#) [AO3415A](#) [AOT470](#) [AOZ8905CI](#)
[AOK60N30L](#) [AOT410L](#) [AON6280](#) [AON6414A](#)