

<p>General Description</p> <ul style="list-style-type: none"> • Trench Power AlphaMOS (αMOS LV) technology • Low $R_{SS(ON)}$ • Fully protected AlphaDFN package • With ESD protection to improve battery performance and safety • Common drain configuration for design simplicity • RoHS and Halogen-Free Compliant <p>Applications</p> <ul style="list-style-type: none"> • Battery protection switch • Mobile device battery charging and discharging 	<p>Product Summary</p> <table style="width: 100%; border: none;"> <tr> <td style="width: 70%;">V_{SS}</td> <td style="text-align: right;">20V</td> </tr> <tr> <td>$R_{SS(ON)}$ (at $V_{GS}=4.5V$)</td> <td style="text-align: right;">< 34mΩ</td> </tr> <tr> <td>$R_{SS(ON)}$ (at $V_{GS}=4.0V$)</td> <td style="text-align: right;">< 38mΩ</td> </tr> <tr> <td>$R_{SS(ON)}$ (at $V_{GS}=3.7V$)</td> <td style="text-align: right;">< 40mΩ</td> </tr> <tr> <td>$R_{SS(ON)}$ (at $V_{GS}=3.1V$)</td> <td style="text-align: right;">< 45mΩ</td> </tr> <tr> <td>$R_{SS(ON)}$ (at $V_{GS}=2.5V$)</td> <td style="text-align: right;">< 56mΩ</td> </tr> </table> <p>Typical ESD protection HBM Class 3A</p> <div style="text-align: right;">  </div>	V_{SS}	20V	$R_{SS(ON)}$ (at $V_{GS}=4.5V$)	< 34mΩ	$R_{SS(ON)}$ (at $V_{GS}=4.0V$)	< 38mΩ	$R_{SS(ON)}$ (at $V_{GS}=3.7V$)	< 40mΩ	$R_{SS(ON)}$ (at $V_{GS}=3.1V$)	< 45mΩ	$R_{SS(ON)}$ (at $V_{GS}=2.5V$)	< 56mΩ
V_{SS}	20V												
$R_{SS(ON)}$ (at $V_{GS}=4.5V$)	< 34mΩ												
$R_{SS(ON)}$ (at $V_{GS}=4.0V$)	< 38mΩ												
$R_{SS(ON)}$ (at $V_{GS}=3.7V$)	< 40mΩ												
$R_{SS(ON)}$ (at $V_{GS}=3.1V$)	< 45mΩ												
$R_{SS(ON)}$ (at $V_{GS}=2.5V$)	< 56mΩ												

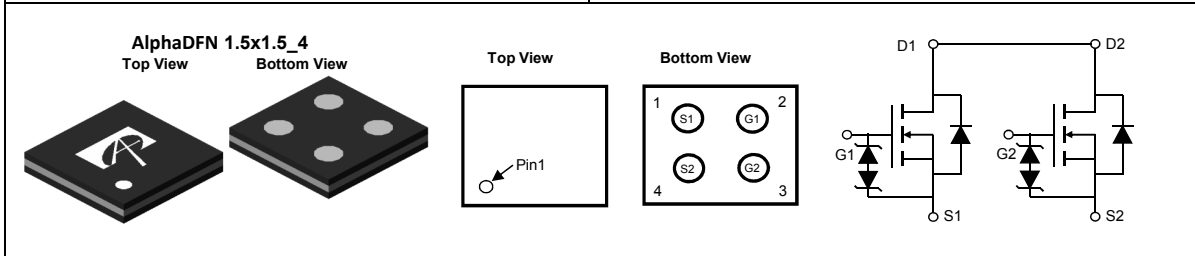

Orderable Part Number	Package Type	Form	Minimum Order Quantity
AOC2804B	AlphaDFN 1.5x1.5_4	Tape & Reel	3000

Absolute Maximum Ratings $T_A=25^\circ C$ unless otherwise noted

Parameter	Symbol	Rating	Units
Source-Source Voltage	V_{SS}	20	V
Gate-Source Voltage	V_{GS}	± 12	V
Source Current(DC) ^{Note1}	I_S	6	A
Source Current(Pulse) ^{Note2}	I_{SM}	60	
Power Dissipation ^{Note1}	P_D	1.3	W
Junction and Storage Temperature Range	T_J, T_{STG}	-55 to 150	$^\circ C$

Thermal Characteristics

Parameter	Symbol	Typ	Units
Maximum Junction-to-Ambient	$R_{\theta JA}$	85	$^\circ C/W$
Maximum Junction-to-Ambient		96	$^\circ C/W$

Note 1. I_S rated value is based on bare silicon. Mounted on 70mmx70mm FR-4 board.
Note 2. PW <10 μs pulses, duty cycle 1% max.

Electrical Characteristics (T_J=25°C unless otherwise noted)

Symbol	Parameter	Conditions	Min	Typ	Max	Units
STATIC PARAMETERS						
BV _{SSS}	Source-Source Breakdown Voltage	I _S =250μA, V _{GS} =0V Test Circuit 6	20			V
I _{SSS}	Zero Gate Voltage Source Current	V _{SS} =20V, V _{GS} =0V Test Circuit 1			1	μA
		T _J =55°C			5	
I _{GSS}	Gate leakage current	V _{SS} =0V, V _{GS} =±10V Test Circuit 2			±10	μA
V _{GS(th)}	Gate Threshold Voltage	V _{SS} =V _{GS} , I _S =250μA Test Circuit 3	0.5	0.9	1.3	V
R _{SS(ON)}	Static Source to Source On-Resistance	V _{GS} =4.5V, I _S =3A Test Circuit 4	20	28	34	mΩ
		T _J =125°C	27	38.5	47	
		V _{GS} =4.0V, I _S =3A Test Circuit 4	22	30.5	38	mΩ
		V _{GS} =3.7V, I _S =3A Test Circuit 4	23	32	40	mΩ
		V _{GS} =3.1V, I _S =3A Test Circuit 4	25	35	45	mΩ
		V _{GS} =2.5V, I _S =3A Test Circuit 4	30	42.5	56	mΩ
g _{FSS}	Forward Transconductance	V _{SS} =5V, I _S =3A Test Circuit 3		20		S
V _{FSS}	Forward Source to Source Voltage	I _S =1A, V _{GS} =0V Test Circuit 5		0.72	1	V
DYNAMIC PARAMETERS						
R _g	Gate resistance	f=1MHz		2		KΩ
SWITCHING PARAMETERS						
Q _g	Total Gate Charge	V _{G1S1} =4.5V, V _{SS} =10V, I _S =3A		9.5		nC
t _{D(on)}	Turn-On DelayTime	V _{G1S1} =4.5V, V _{SS} =10V, R _L =3.3Ω, R _{GEN} =3Ω Test Circuit8		0.85		μs
t _r	Turn-On Rise Time			2.2		μs
t _{D(off)}	Turn-Off DelayTime			2.0		μs
t _f	Turn-Off Fall Time			4.3		μs

THIS PRODUCT HAS BEEN DESIGNED AND QUALIFIED FOR THE CONSUMER MARKET. APPLICATIONS OR USES AS CRITICAL COMPONENTS IN LIFE SUPPORT DEVICES OR SYSTEMS ARE NOT AUTHORIZED. AOS DOES NOT ASSUME ANY LIABILITY ARISING OUT OF SUCH APPLICATIONS OR USES OF ITS PRODUCTS. AOS RESERVES THE RIGHT TO IMPROVE PRODUCT DESIGN, FUNCTIONS AND RELIABILITY WITHOUT NOTICE.

TYPICAL ELECTRICAL AND THERMAL CHARACTERISTICS

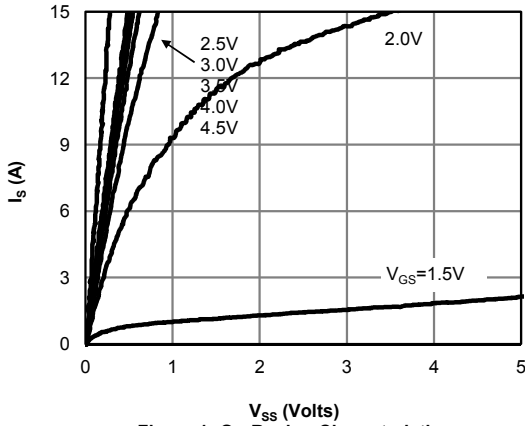

Figure 1: On-Region Characteristics

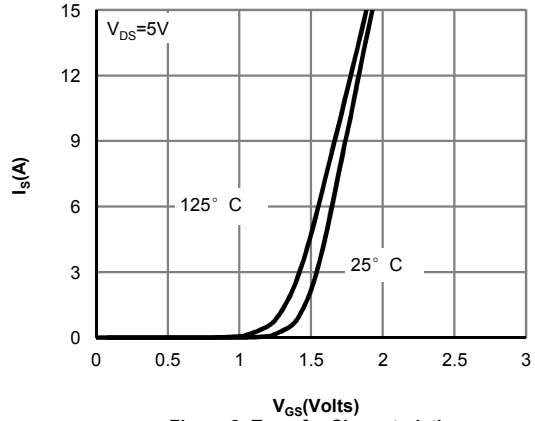

Figure 2: Transfer Characteristics

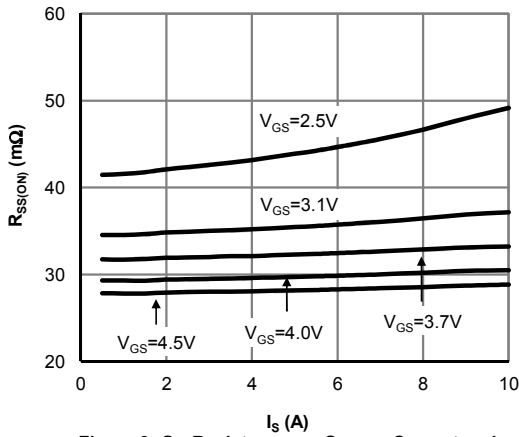

Figure 3: On-Resistance vs. Source Current and Gate Voltage

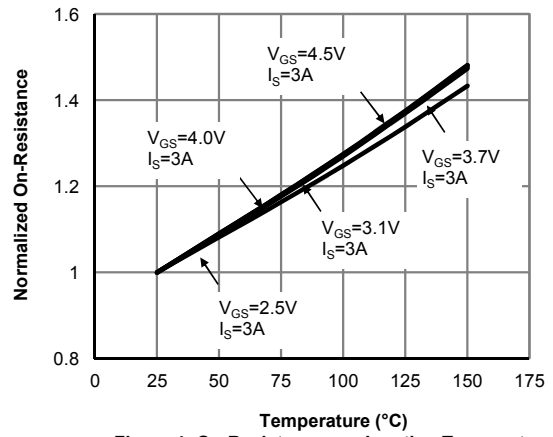

Figure 4: On-Resistance vs. Junction Temperature

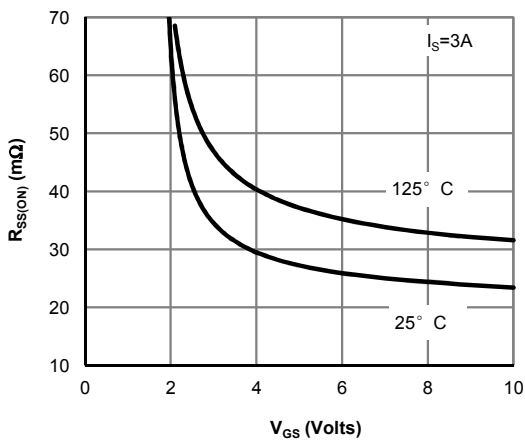

Figure 5: On-Resistance vs. Gate-Source Voltage

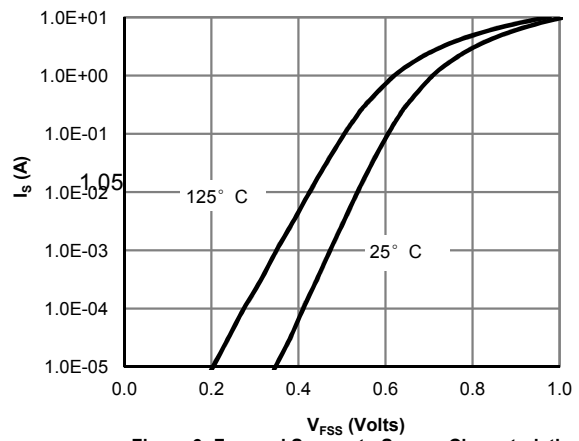

Figure 6: Forward Source to Source Characteristics

TYPICAL ELECTRICAL AND THERMAL CHARACTERISTICS

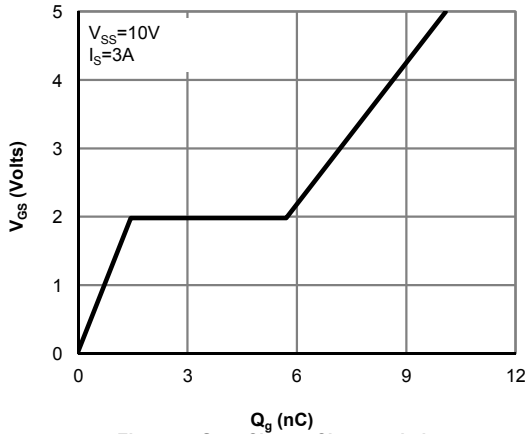

Figure 7: Gate-Charge Characteristics

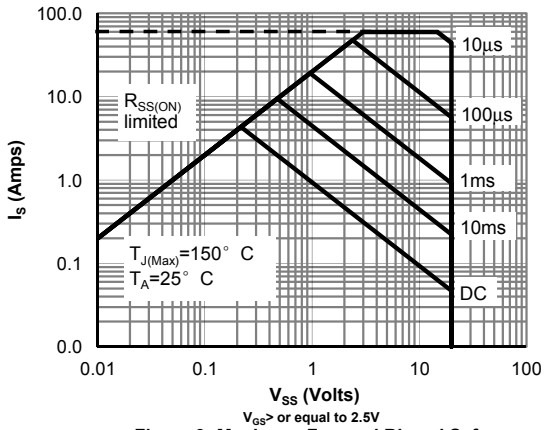

Figure 9: Maximum Forward Biased Safe Operating Area (Note1)

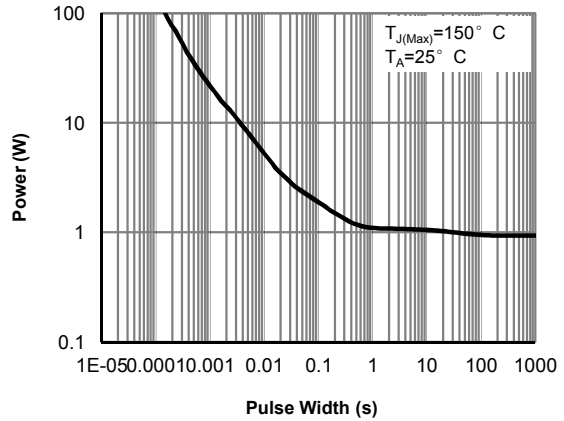

Figure 10: Single Pulse Power Rating Junction-to-Ambient (Note1)

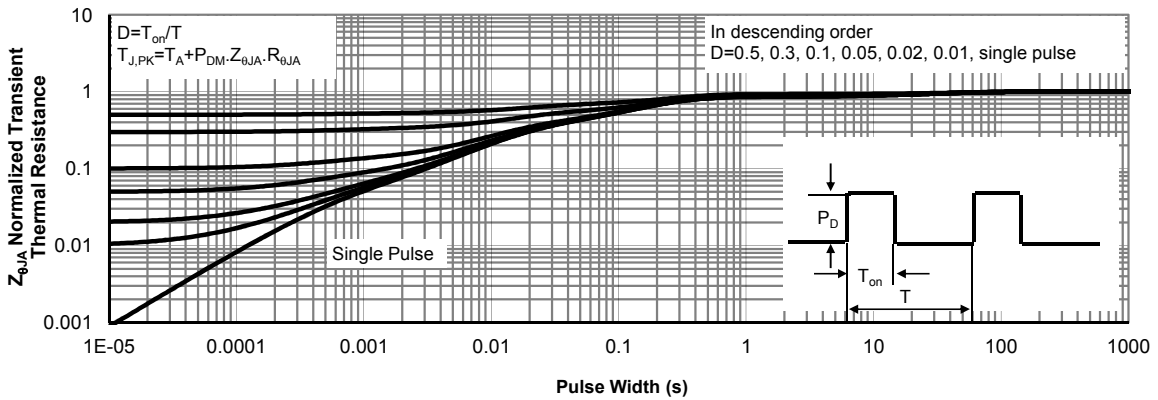
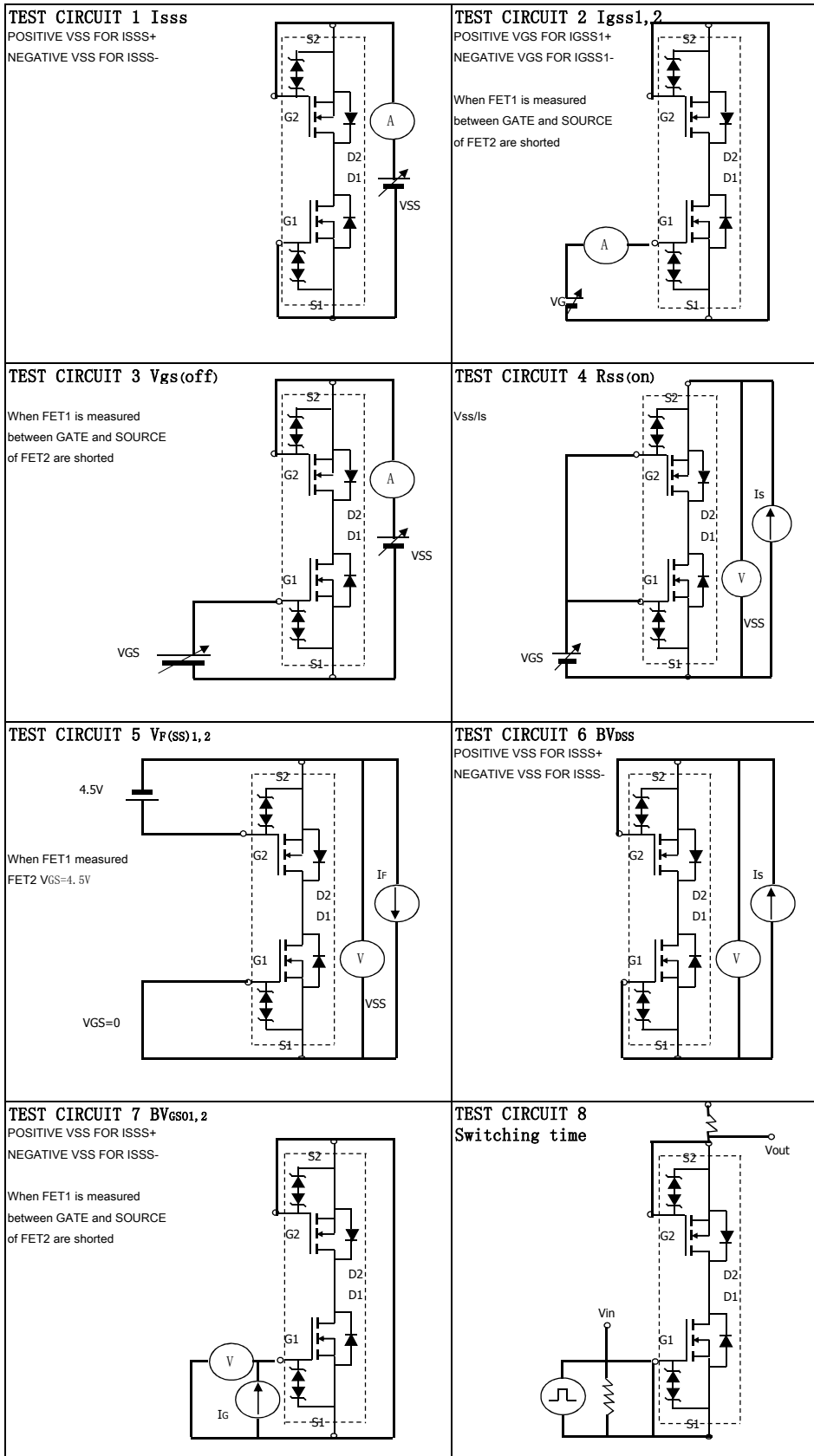

Figure 11: Normalized Maximum Transient Thermal Impedance (Note1)



X-ON Electronics

Largest Supplier of Electrical and Electronic Components

Click to view similar products for [MOSFET](#) category:

Click to view products by [Alpha & Omega](#) manufacturer:

Other Similar products are found below :

[614233C](#) [648584F](#) [FDPF9N50NZ](#) [IRFD120](#) [JANTX2N5237](#) [2N7000](#) [FCA20N60_F109](#) [FDZ595PZ](#) [2SK2545\(Q,T\)](#) [405094E](#) [423220D](#)
[TPCC8103,L1Q\(CM](#) [MIC4420CM-TR](#) [VN1206L](#) [614234A](#) [715780A](#) [NTNS3166NZT5G](#) [SSM6J414TU,LF\(T](#) [751625C](#) [IPP110N20N3GXX](#)
[IPS70R2K0CEAKMA1](#) [DMN3404LQ-7](#) [NTE6400](#) [2SK2614\(TE16L1,Q\)](#) [DMN1017UCP3-7](#) [EFC2J004NUZTDG](#) [ECH8691-TL-W](#)
[FCAB21350L1](#) [P85W28HP2F-7071](#) [DMN1053UCP4-7](#) [NTE221](#) [NTE2384](#) [NTE2903](#) [NTE2941](#) [NTE2945](#) [NTE2946](#) [NTE2960](#) [NTE2969](#)
[NTE2976](#) [NTE455](#) [NTE6400A](#) [NTE2910](#) [NTE2916](#) [NTE2956](#) [NTE2911](#) [TK10A80W,S4X\(S](#) [SSM6P69NU,LF](#) [DMP22D4UFO-7B](#)
[DMN1006UCA6-7](#) [DMN16M9UCA6-7](#)